

QBiX-PPC-101A3940T-A1 (PS-3940A-SI)

10.1" Industrial Panel PC System
Quick Start Guide

Copyright Notice

This document is copyrighted, 2022. All rights are reserved. The original manufacturer reserves the right to make improvements to the products described in this manual at any time without notice.

No part of this manual may be reproduced, copied, translated, or transmitted in any form or by any means without the prior written permission of the original manufacturer. Information provided in this manual is intended to be accurate and reliable. However, the original manufacturer assumes no responsibility for its use, or for any infringements upon the rights of third parties that may result from its use.

The material in this document is for product information only and is subject to change without notice. While reasonable efforts have been made in the preparation of this document to assure its accuracy, GIGAIPC assumes no liabilities resulting from errors or omissions in this document, or from the use of the information contained herein.

GIGAIPC reserves the right to make changes in the product design without notice to its users.

Acknowledgement

All other products' name or trademarks are properties of their respective owners.

- AMD is trademark of Advanced Micro Devices.
- Microsoft Windows is a registered trademark of Microsoft Corp.
- Intel, Pentium, Celeron, and Xeon are registered trademarks of Intel Corporation
- Core, Atom are trademarks of Intel Corporation
- ITE is a trademark of Integrated Technology Express, Inc.
- IBM, PC/AT, PS/2, and VGA are trademarks of International Business Machines Corporation.

All other product names or trademarks are properties of their respective owners.

Packing List

Before setting up your product, please make sure the following items have been shipped:

Item	Quantity
System kit	1
Terminal Blocks Male Plug	1
Camera Bracket	1
Thermal pad for Memory (25ST3-200051-T5R)	1

If any of these items are missing or damaged, please contact your distributor or sales representative immediately.

About this Document

This User's Manual contains all the essential information, such as detailed descriptions and explanations on the product's hardware and software features (if any), its specifications, dimensions, jumper/connector settings/definitions, and driver installation instructions (if any), to facilitate users in setting up their product.

Users may refer to the GIGAIPC.com for the latest version of this document.

Safety Precautions

Please read the following safety instructions carefully. It is advised that you keep this manual for future references

1. All cautions and warnings on the device should be noted.
2. Make sure the power source matches the power rating of the device.
3. Position the power cord so that people cannot step on it. Do not place anything over the power cord.
4. Always completely disconnect the power before working on the system's hardware.
5. No connections should be made when the system is powered as a sudden rush of power may damage sensitive electronic components.
6. If the device is not to be used for a long time, disconnect it from the power supply to avoid damage by transient over-voltage.
7. Always disconnect this device from any AC supply before cleaning.
8. While cleaning, use a damp cloth instead of liquid or spray detergents.
9. Make sure the device is installed near a power outlet and is easily accessible.
10. Keep this device away from humidity.
11. Place the device on a solid surface during installation to prevent falls
12. Do not cover the openings on the device to ensure optimal heat dissipation.

13. Watch out for high temperatures when the system is running.
14. Do not touch the heat sink or heat spreader when the system is running
15. Never pour any liquid into the openings. This could cause fire or electric shock.
16. As most electronic components are sensitive to static electrical charge, be sure to ground yourself to prevent static charge when installing the internal components. Use a grounding wrist strap and contain all electronic components in any static-shielded containers.
17. If any of the following situations arises, please the contact our service personnel:
 - i. Damaged power cord or plug
 - ii. Liquid intrusion to the device
 - iii. Exposure to moisture
 - iv. Device is not working as expected or in a manner as described in this manual
 - v. The device is dropped or damaged
 - vi. Any obvious signs of damage displayed on the device
- 18. DO NOT LEAVE THIS DEVICE IN AN UNCONTROLLED ENVIRONMENT WITH TEMPERATURES BEYOND THE DEVICE'S PERMITTED STORAGE TEMPERATURES (SEE CHAPTER 1) TO PREVENT DAMAGE.**

FCC Statement

Warning!



This device complies with Part 15 FCC Rules. Operation is subject to the following two conditions: (1) this device may not cause harmful interference, and (2) this device must accept any interference received including interference that may cause undesired operation.

Caution:

There is a danger of explosion if the battery is incorrectly replaced. Replace only with the same or equivalent type recommended by the manufacturer. Dispose of used batteries according to the manufacturer's instructions and your local government's recycling or disposal directives.

Attention:

Il y a un risque d'explosion si la batterie est remplacée de façon incorrecte. Ne la remplacer qu'avec le même modèle ou équivalent recommandé par le constructeur. Recycler les batteries usées en accord avec les instructions du fabricant et les directives gouvernementales de recyclage.

High Temperature Warning

(1) This equipment is intended to be used in Restrict Access Location. The access can only be gained by Skilled person or by Instructed person who have been instructed about the metal chassis of the equipment is so hot that Skilled person have to pay special attention or take special protection.

Only authorized by well trained professional person can access the restrict access location.

(2) External metal parts are hot!! Before touching it, special attention or protection is necessary



Table Contents

10.1” Industrial Panel PC System	1
Quick Start Guide	
Copyright Notice	2
Acknowledgement	3
Packing List.....	4
About this Document.....	5
Safety Precautions	6
FCC Statement.....	8
High Temperature Warning	8
Chapter 1 - Product Specifications	11
1.1 Specifications	13
Chapter 2 – QBiX-PPC-101A3940T-A1	15
Industrial Panel PC System Kit	
2.1 Dimension	16
2.2 Getting Familiar with Your Unit.....	17
2.3 M.2 SSD Installation: How to safely install the M.2 2242 SSD	19
2.4 Memory Installation: DDR3L SO-DIMM	20
2.5 Mini PCIe Card Installation: How to safely install the Mini PCIe Card	21
2.6 Antenna Installation (Antenna inclusion may vary based on local distribution)	22

2.7	Cable Pin-define	23
2.8	Safety and Regulatory Information.....	24

Chapter 3 – Hardware Information 25

3.1	Jumpers and Connectors	26
3.2.1	FAN (FAN connector)	29
3.2.2	DC IN (DC IN 1 x 4-pin power connector)	30
3.2.3	COM1, COM2, COM3, COM4 (Serial port header)	31
3.2.4	SPK_OUT (Speaker out connector)	32
3.2.5	JCOM11 (COM11 RI# pin RI#/5V/12V Select).....	33
3.2.6	JRS11-JRS14 (RS11-14 select jumper for serial port).....	34
3.2.7	AT_CN (AT/ATX power mode select jumper)	35
3.2.8	LSW (LVDS resolution jumper)	36
3.2.9	LVDS (LVDS connector).....	37
3.2.10	BKL_CN (Back light brightness control connector).....	38
3.2.11	BUZZER.....	39
3.2.12	BATTERY	40
3.2.13	SATAPW (SATA power connector).....	41
3.2.14	SATAIII (SATA 6Gb/S Connector).....	42
3.2.15	FUSB20_1, FUSB2_2 (USB 2.0 header).....	43
3.2.16	GPIO_CNT (General Purpose input/output header) ...	44
3.2.17	SYS_PANEL (Front panel header)	45
3.2.18	CLS_CMOS (Clean CMOS jumper).....	46

Chapter 4 – BIOS	47
4.1 Introduction	48
4.2 The Main Menu.....	49
4.3 Advanced	50
4.3.1 TPM Configuration.....	51
4.3.2 IT8786 Super IO Configuration	53
4.3.3 Hardware Monitor	54
4.3.4 S5 RTC Wake Settings	55
4.3.5 CPU Configuration	56
4.3.6 SATA Configuration	57
4.3.7 CSM Configuration.....	58
4.4 Chipset	59
4.5 Security	60
4.6 Boot.....	63
4.7 Save & Exit	64

Chapter 1

Chapter 1 - Product Specifications

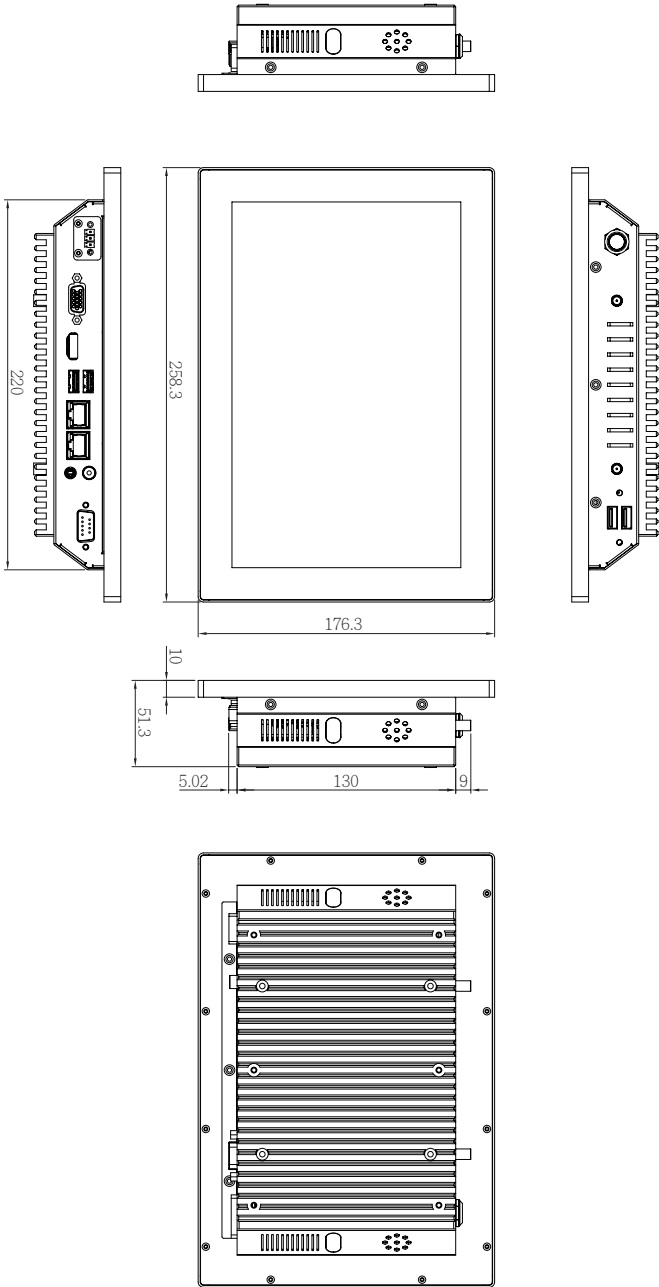

1.1 Specifications

System	QBiX-PPC-101A3940T-A1 (PS-3940A-SI)
Dimension	System Size : 285.3W x 51.3D x 176.3H (mm)
Motherboard	QBiP-3940A
LCD	Display Type : 10.1" TFT LCD panel Resolution : 1280 x 800 Brightness : 300 cd/m ² View angel : 80°/85° (H), 80°/85° (V) Contrast Ratio : 1300:1 Response time : 25 ms Backlight lifetime : 15,000 hrs
Touch screen	Type : 10 points, projected capacitive Viewing Area : 217.46L x 136.1W Active Area : 216.96L x 135.6W Surface Hardness : >=3H Transparency : >85%
CPU	Intel® Atom® x5-E3940 Processor 14nm, 4 cores, 4 threads, up to 1.8 GHz TDP 9.5W
Memory	2 x DDR3L SO-DIMM sockets, Max. Capacity 8 GB Support Dual channel DDR3L 1866 MHz memory modules
Ethernet	2 x GbE LAN Ports (Intel® I211AT)
Expansion Slots	1 x 2242 M.2 M-Key (SATA 6Gb/s) 1 x Full-size Mini PCIe with SIM slot (PCIe x1 + USB2.0) -- support 3G module
I/O	1 x COM Port (RS-232/422/485 & RI/5V/12V) 1 x Headphone Jack 2 x RJ45 LAN Ports 2 x USB 3.2 Gen 1 1 x HDMI 1 x D-sub 1 x 3-pin Terminal block 1 x Power button with LED 2 x USB 2.0 2 x External Antenna Holes (Optional)
Speaker	2 x 2W speaker
Power	+12V~36VDC (Full Range)

System	QBiX-PPC-101A3940T-A1 (PS-3940A-SI)
Operation Temperature	Operating temperature: 0°C to 60°C Operating humidity: 0-90% (non-condensing) Non-operating temperature: -40°C to 70°C Non-operating humidity: 0%-95% (non-condensing) Use wide temperature range memory and storage
Vibration During Operation	Operation: IEC 60068-2-64, 1 Grms, random, 5 ~ 500 Hz, 1 hr / Per Axis, with SSD/M.2 2242 Non-operation: IEC 60068-2-6, 2 G, Sine, 10 ~ 500 Hz, 1 Oct/min, 1 hr / Per Axis
Shock During Operation	Operation: IEC 60068-2-27, 50 G, half sine, 11 ms duration, With SSD
Packaging Content	Carton size: 505 x 324 x 358 (mm) Packing Capacity: 4pcs Including: Thermal Pad for Memory x 1 (P/N: 25ST3-200051-T5R) Camera Bracket x 1 Terminal Blocks Male Plug x 1
Order Information	System: 6BPS3940AMR-SI (Box packing)

Chapter 2

Chapter 2 – QBiX-PPC-101A3940T-A1 Industrial Panel PC System Kit

2.1 Dimension

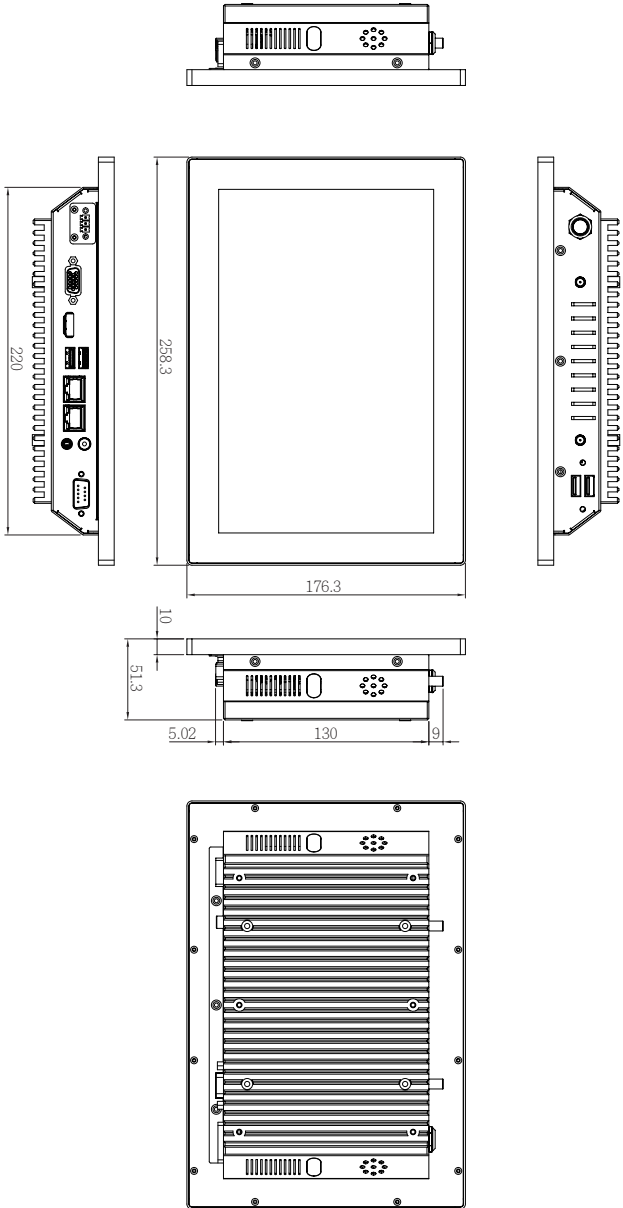

2.2 Getting Familiar with Your Unit

[Front Side]

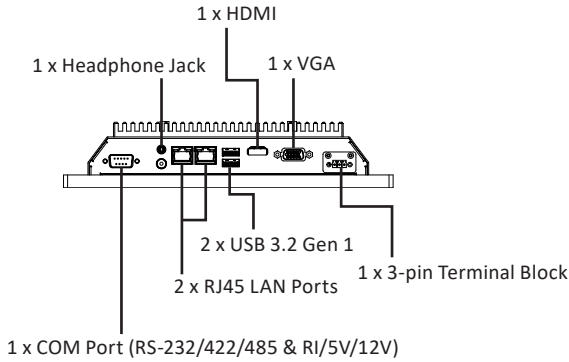

[Left Side]



[Rear Side]

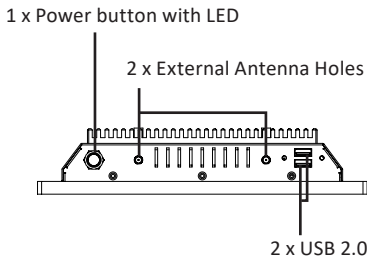

[Right Side]

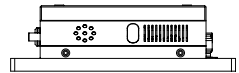

[Install]

- * Before opening the case, make sure to unplug the power cord.
- * Before Connecting the power, make sure to fasten the case securely.

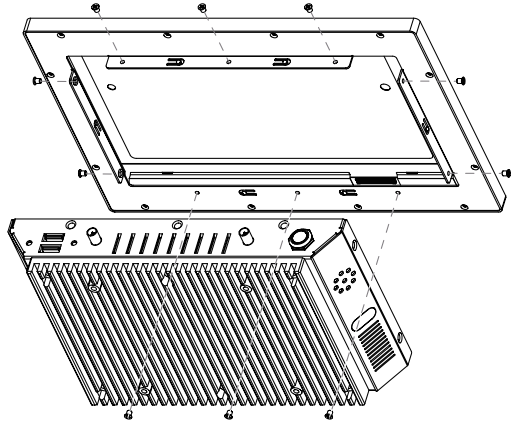
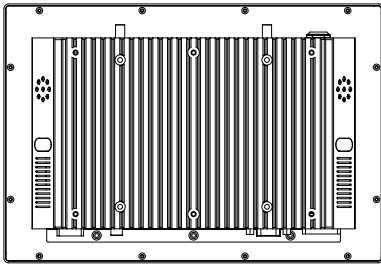

[Bottom PCB Side]

Information	
A	2 x DDR3L SO-DIMM sockets, DDR3L 1866 MHz, Max. Capacity 8 GB
B	1 x Mini PCIe slot (PCIe x1 + USB2.0) with SIM Slot
C	1 x M.2 slot (Support NGFF-2242 SATA 6Gb/s)

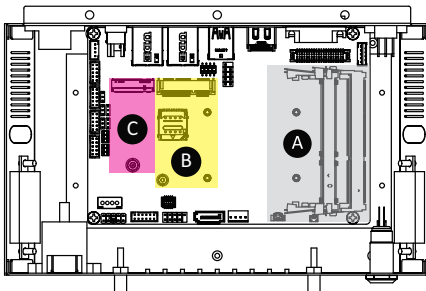

2.3 M.2 SSD Installation: How to safely install the M.2 2242 SSD

1

Remove 4 screws and disassemble the heat-plate.

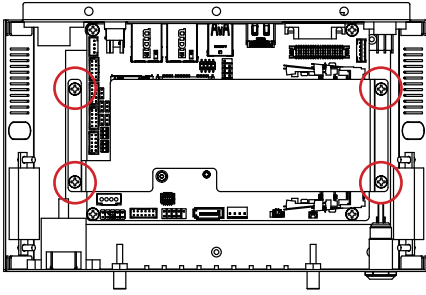

2

Remove the screw from the screw hole (Location : MSO2)

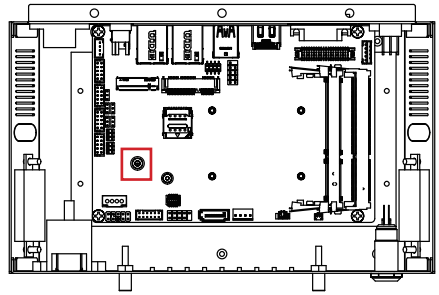

3

Carefully insert the M.2 SSD into the slot, and secure with the screw.

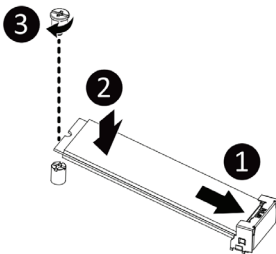

2.4 Memory Installation: DDR3L SO-DIMM

1

Remove 4 screws and disassemble the heat-plate.

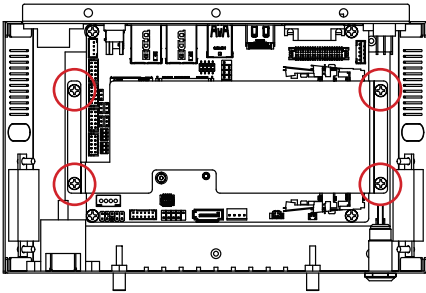

2

Carefully insert SO-DIMM memory modules.

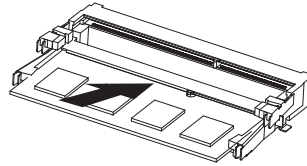

3

Push down until the modules click into place.

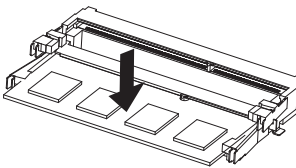

4

Carefully insert SO-DIMM memory modules.

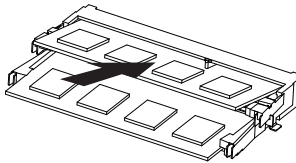

5

Push down until the modules click into place.

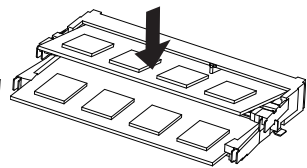

2.5 Mini PCIe Card Installation: How to safely install the Mini PCIe Card

1

Remove 4 screws and disassemble the heat-plate.

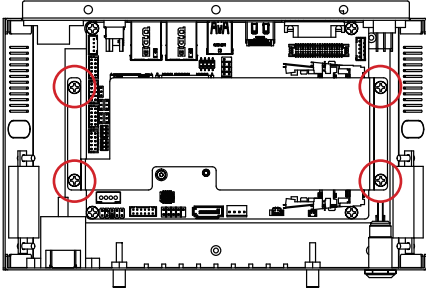

2

Remove the screw from the screw hole (Location : MSO1)

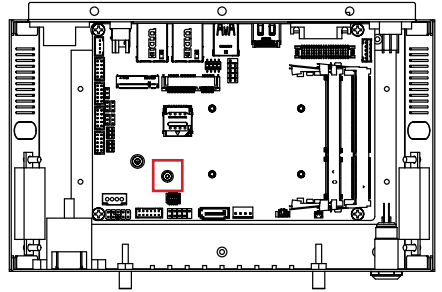

3

Carefully insert the Mini PCIe Card into the slot.

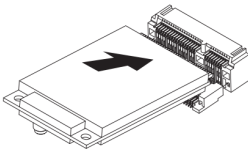

4

Secure the Mini PCIe Card with screw.

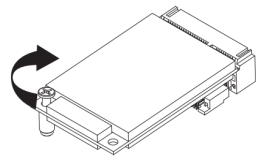

2.6 Antenna Installation (Antenna inclusion may vary based on local distribution)

1

Carefully insert the antennas into the connectors.

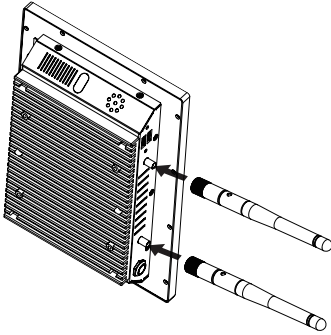

2

Turn the antennas clockwise until they are completely secure on the connectors.

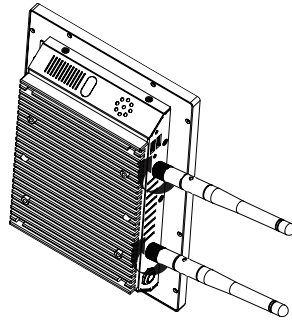

3

Flip up the antenna heads so that they are perpendicular to the machine.

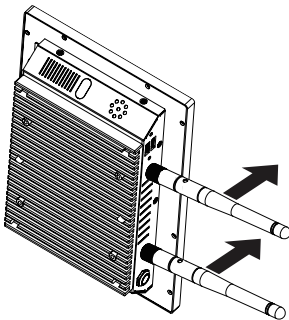

2.7 Cable Pin-define

1. DB9 COM (25CF8-210620-S9R)

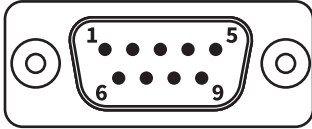

DB9 Pin Define

DB9 Pin	RS-232	RS-422 Full Duplex	RS-485 Half Duplex
1	DCD	TXD-	D-
2	RXD	TXD+	D+
3	TXD	RXD+	-
4	DTR	RXD-	-
5	GND		
6	DSR	-	-
7	RTS	-	-
8	CTS	-	-
9	RI	-	-

2.8 Safety and Regulatory Information

Risk of explosion if the battery is replaced with an incorrect type.
Batteries should be recycled where possible.

Disposal of used Batteries must be in accordance with local environmental regulations.

Failure to use the included Power Adapter may violate regulatory compliance and may expose the user to safety hazards.

HDMI™
HIGH DEFINITION MULTIMEDIA INTERFACE



At the end of its serviceable life, this product should not be treated as household or general waste. It should be handed over to the applicable collection point for the recycling of electrical and electronic equipment, or returned to the supplier for disposal.

Chapter 3

Chapter 3 – Hardware Information

3.1 Jumpers and Connectors

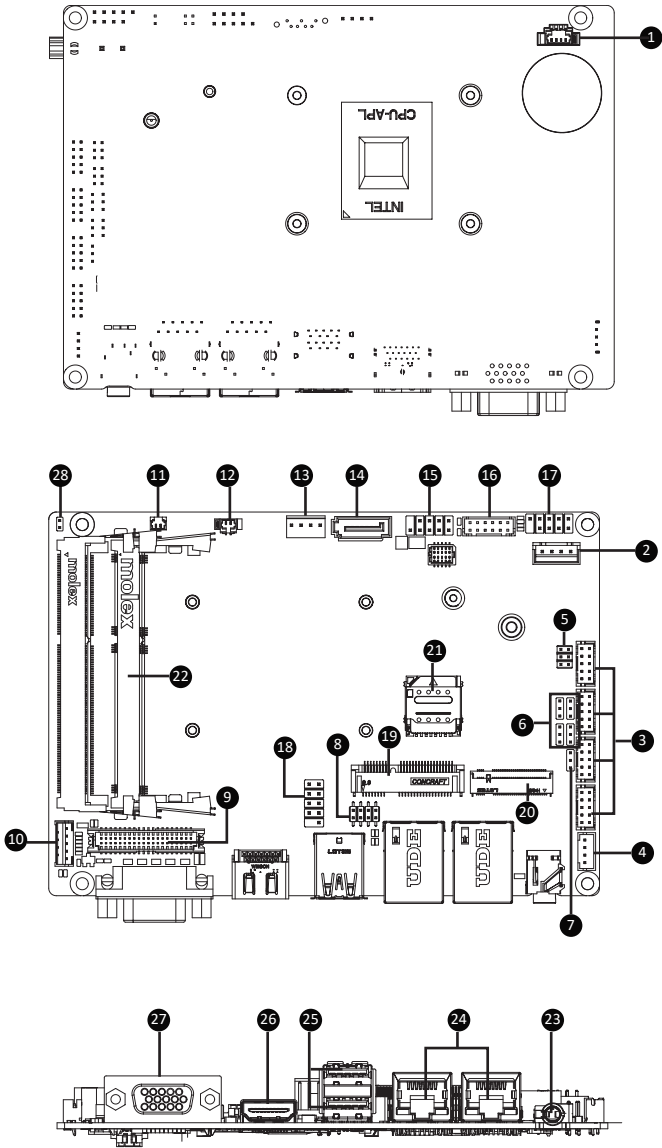

No	Code	Description
1	FAN	FAN connector
2	DC_IN	DC IN 1x4pin power connector
3	COM1 COM2 COM3 COM4	Serial port header
4	SPK_OUT	Speaker out connector
5	JCOM11	COM11 RI# pin RI#/5V/12V Select
6	JRS11-JRS14	RS11-14 select jumper for serial port
7	AT_CN	AT/ATX power mode select jumper
8	LSW	LVDS resolution jumper
9	LVDS	LVDS connector
10	BKL_CN	Back light brightness control connector
11	BUZZER	—
12	BATTERY	Battery cable connector
13	SATAPW	SATA power connector
14	SATAIII	SATA 6Gb/s connector
15	FUSB20_1	USB 2.0 header
16	GPIO_CNT	General Purpose input/output header
17	SYS_PANEL	Front panel header
18	FUSB2_2	USB 2.0 header
19	MPCIE	Mini-PCIe slot
20	M2M	M.2 slot
21	SIM_CARD1	3G/4G Sim Slot

No	Code	Description
22	SODIMMA/B	2 x DDR3L SO-DIMM sockets, Max. Capacity 8 GB Dual channel memory architecture Support DDR3L 1866MHz memory modules
23	Audio jack	Line out
24	LAN1, LAN2	2 x RJ45 Ports
25	FUSB30	2 x USB3.0 Ports
26	HDMI	1 x HDMI Port
27	VGA	1 x VGA Port
28	CLS_CMOS	1 x Clear CMOS jumper

3.2.1 FAN (FAN connector)

1

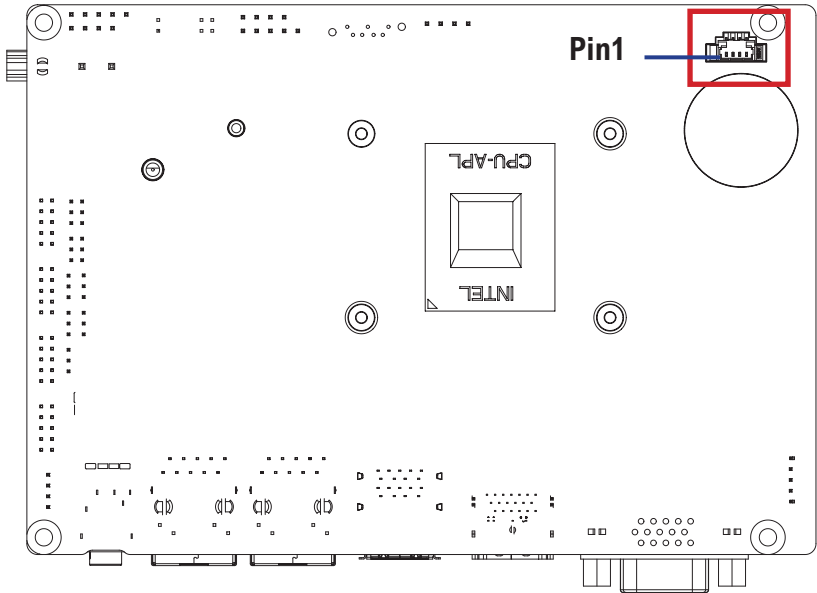

CPU/System FAN

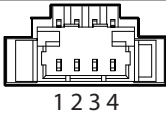

Connector PN	Vendor
A1250WV-S-04PC	JOINT-TECH

Pin No.	Definition
1	GND
2	12V
3	Detect
4	Speed Control

Connector PN	Vendor
85205-0470N	ACES

3.2.2 DC IN (DC IN 1 x 4-pin power connector)

2

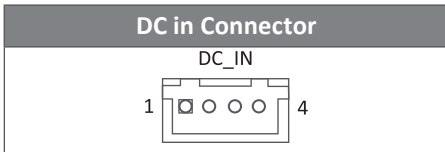
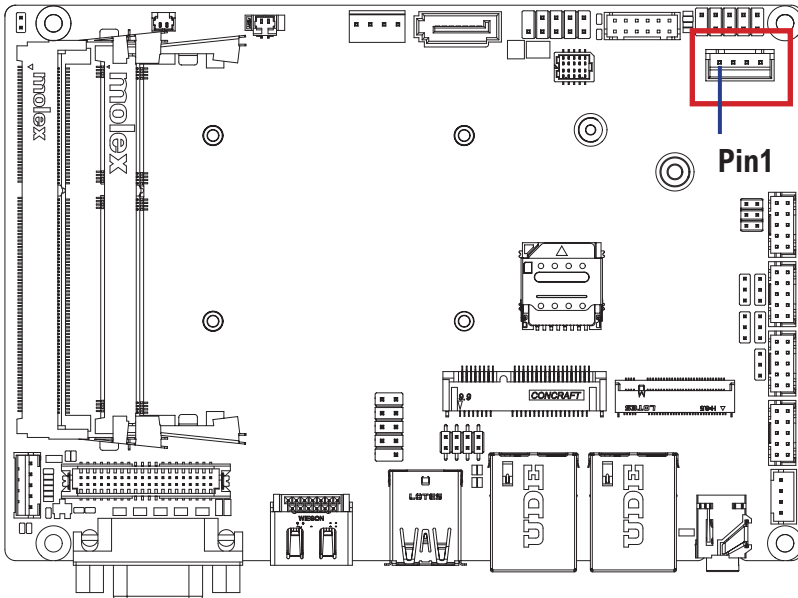

Connector PN	Vendor
753-81-04TW00	PINREX

Pin No.	Definition
1	GND
2	DCIN
3	DCIN
4	GND

3.2.3 COM1, COM2, COM3, COM4 (Serial port header)

3

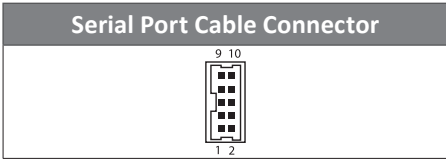
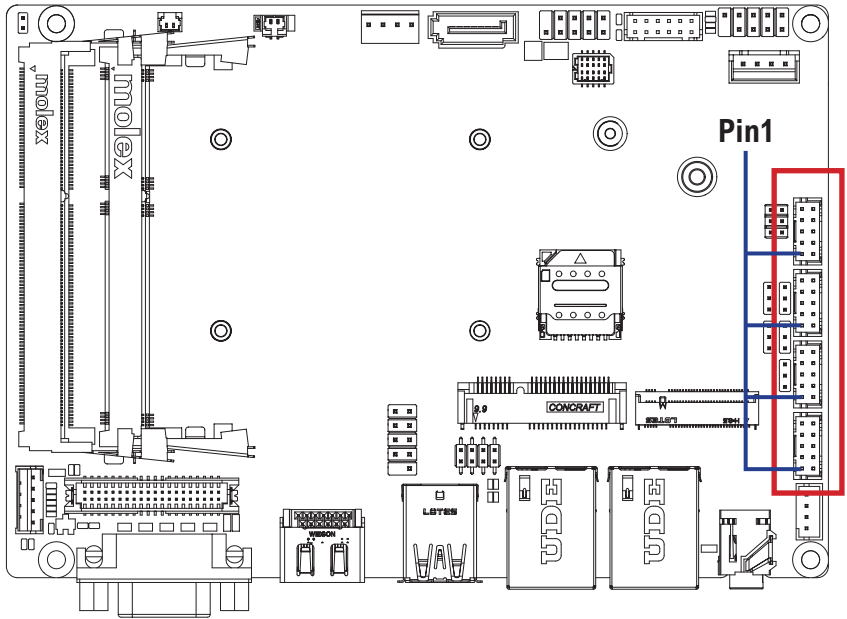

Connector PN	Vendor
725-81-10TW00	PINREX
A2004WV-2X05P46	JOINT-TECH

Pin No.	Definition
1	RXD
2	DCD
3	DTR
4	TXD
5	DSR
6	GND
7	CTS
8	RTS
9	No Connect
10	RI/5V/12V

3.5" SBC Boards QBIP-4200B / 4200C / 3350A / E3940A / E3940AT

3.2.4 SPK_OUT (Speaker out connector)

4

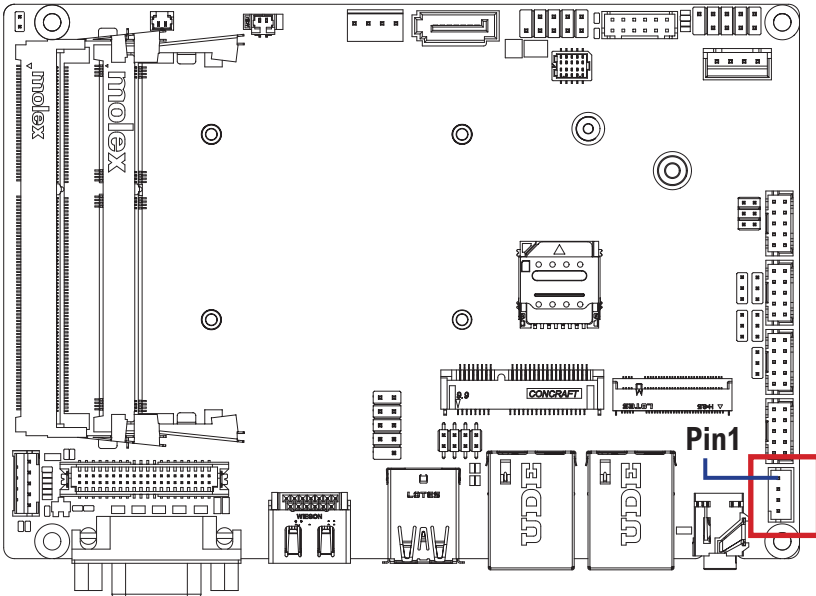

Speaker out connector	

Connector PN	Vendor
721-81-045W00	PINREX
A2001WV-04P146	JOINT-TECH

Pin No.	Definition
1	Speaker Out R+
2	Speaker Out R-
3	Speaker Out L-
4	Speaker Out L+

3.2.5 JCOM11 (COM11 RI# pin RI#/5V/12V Select)

5

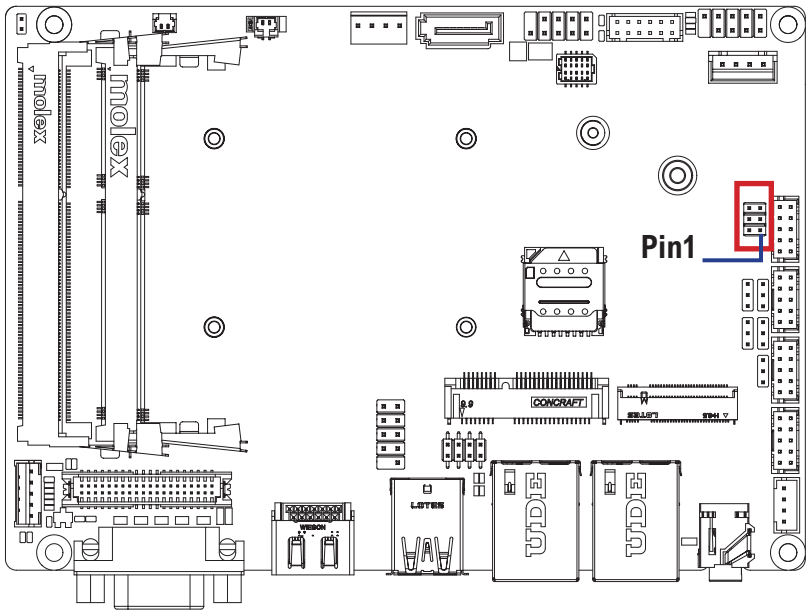

JCOM11 Jumper Select	
	1-2 Close: 5V (Power COM)
	3-4 Close: RI (Stand COM)
	5-6 Close: 12V (Power COM)

Connector PN	Vendor
220-97-03GB01	PINREX
PH06N53BAZ000	HORNGTONG

3.2.6 JRS11-JRS14 (RS11-14 select jumper for serial port)

6

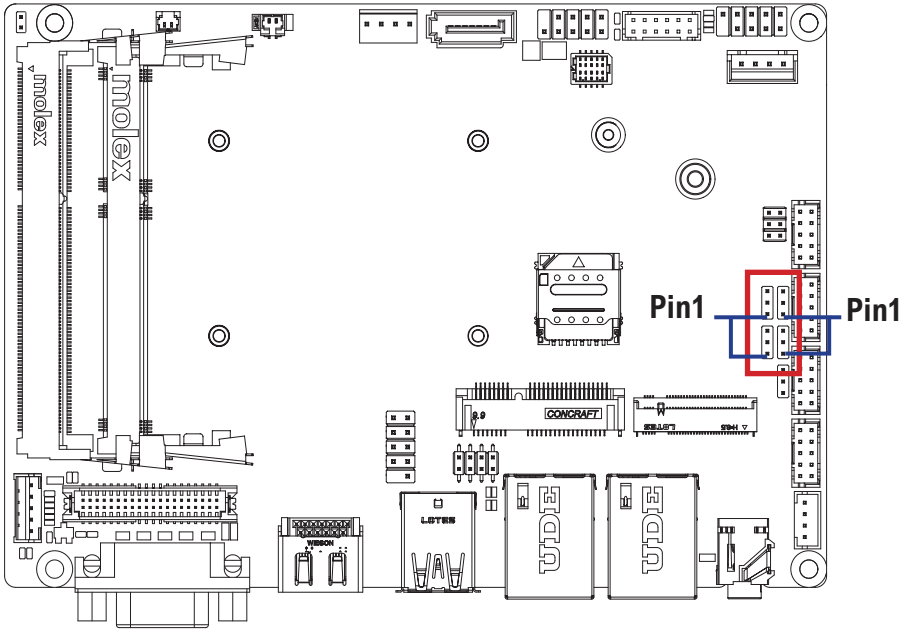

JRS 11-14 Jumper			
JRS13	JRS14		
		123	
		123	
JRS12	JRS11		
RS-232 (Default)			

Connector PN	Vendor
220-96-03GB01	PINREX
PH03N2-7BAN000	HORNGTONG

HW jump Configuration
Pin1, Pin2 Close is 1
Pin2, Pin3 Close is 0

JRS11	JRS12	JRS13	Mode	Status
0	0	0	RS-422 Full Duplex	1T/1R RS-422
0	0	1	Pure RS-232	3T/5R RS-232 (Default)
0	1	0	RS-485 Half Duplex	1T/1R RS-485, TX ENABLE Low Active
0	1	1	RS-485 Half Duplex	1T/1R RS-485, TX ENABLE High Active

3.2.7 AT_CN (AT/ATX power mode select jumper)

7

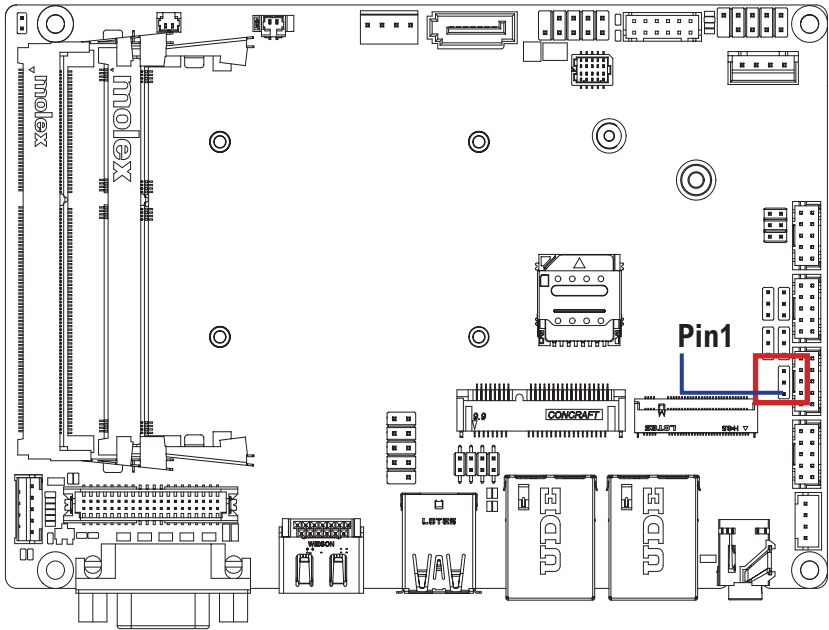

AT/ATX power mode select jumper



- 1-2 Close : AT mode.
- 2-3 Close : ATX mode.
(Default setting)

Connector PN

- 220-96-03GB01
- PH03N2-7BAN000

Vendor

- PINREX
- HORNGTONG

Pin No.









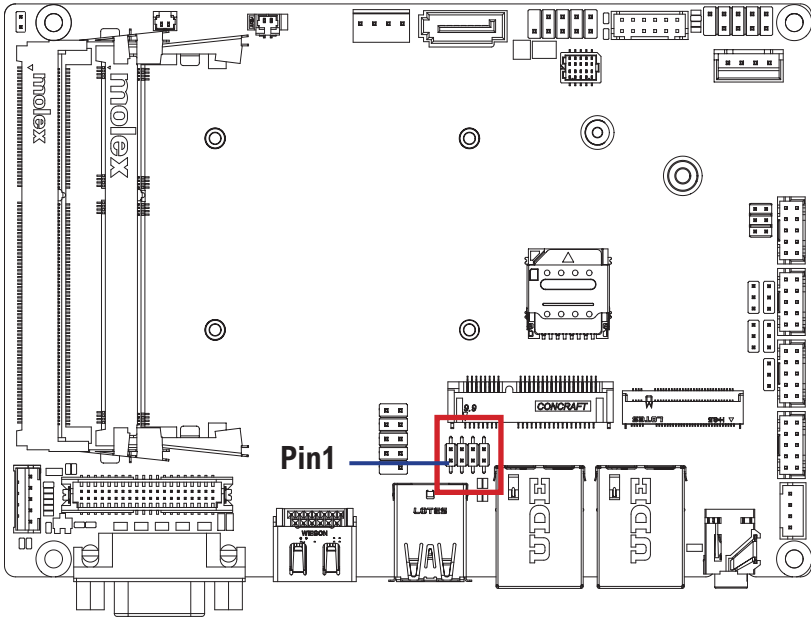







Definition

1	AT MODE
2	Detect
3	ATX MODE

3.2.8 LSW (LVDS resolution jumper)

8



LVDS Resolution Jumper			
Jumper Setting	Resolution	Jumper Setting	Resolution
1 	800 x 600 18bit (default)	1 	1366 x 768 24bit
1 	1024 x 768 18bit	1 	1440 x 900 24bit
1 	1024 x 768 24bit	1 	1400 x 1050 24bit
1 	1024 x 600 18bit	1 	1600 x 900 24bit
1 	1280 x 800 18bit	1 	1680 x 1050 24bit
1 	1280 x 960 18bit	1 	1600 x 1200 24bit
1 	1280 x 1024 24bit	1 	1920 x 1080 24bit
1 	1366 x 768 18bit	1 	1920 x 1200 24bit

Connector PN	Vendor
222-97-04GBE1	PINREX

3.2.9 LVDS (LVDS connector)

9

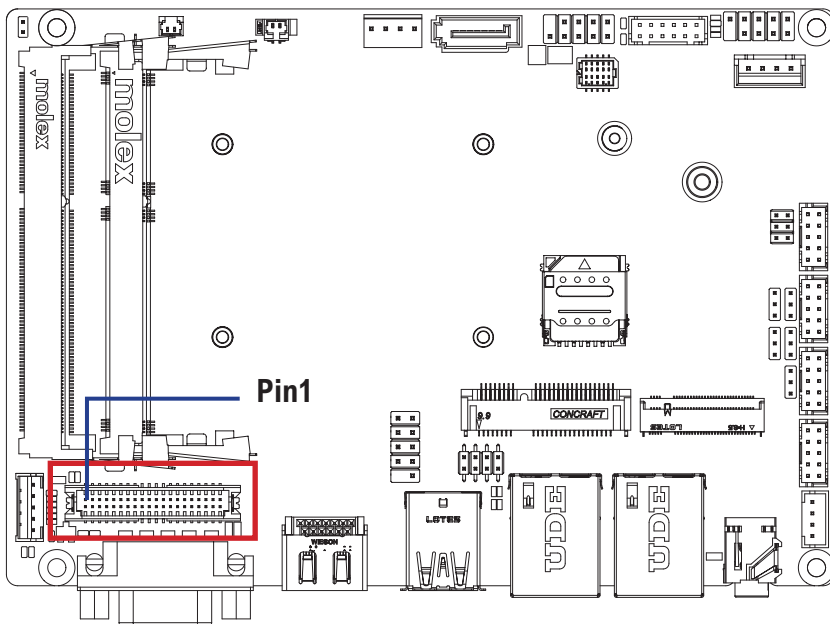

LVDS Connector

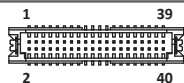

Pin No.	Definition	Pin No.	Definition
17	A3-	37	GND
18	A2-	38	GND
19	GND	39	12V
20	GND	40	12V

Pin No.	Definition	Pin No.	Definition
1	3.3V	21	A5+
2	5V	22	A4+
3	3.3V	23	A5-
4	5V	24	A4-
5	SPE0	25	GND
6	SPE0	26	GND
7	GND	27	A7+
8	GND	28	A6+
9	A1+	29	A7-
10	A0+	30	A6-
11	A1-	31	GND
12	A0-	32	GND
13	GND	33	CLK2+
14	GND	34	CLK1+
15	A3+	35	CLK2-
16	A2+	36	CLK1-

For each model support LVDS function.
But below model no need to add.
A0~A3 is odd channel 0~3, A4~A7 is even channel.

Connector PN	Vendor
712-76-40GWE0	PINREX
A1252WV-SF-2X20PD01	JOINT-TECH

Note: *The LVDS output connector of the unit is only intended to be connected to an UL/IEC/EN approval equipment with fire enclosure.

3.2.10 BKL_CN (Back light brightness control connector)

10

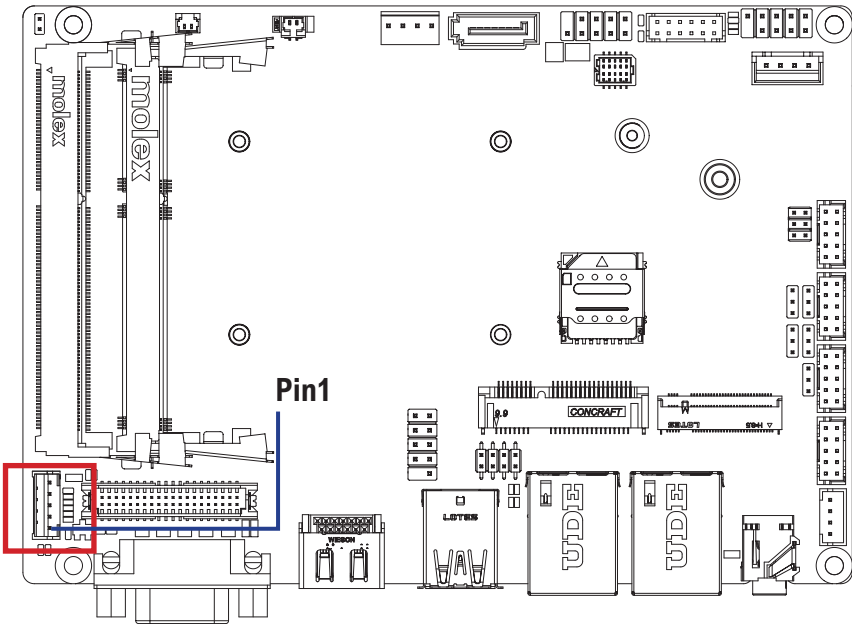

Back light brightness control connector

5



1

Connector PN

Vendor

721-81-05TW00

PINREX

A2001WV-05P146

JOINT-TECH

Pin No.	Definition
1	5V (option 12V)
2	PWM
3	Back Light Enable
4	GND
5	12V

3.2.11 BUZZER

11

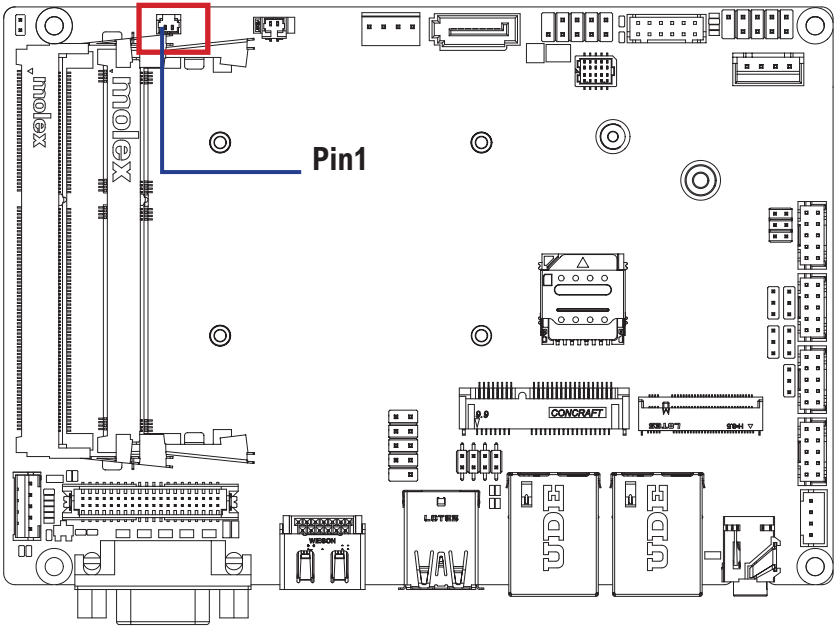

Buzzer



Connector PN

712-71-02TW01

A1250WV-02P

Vendor

PINREX

JOINT-TECH

Pin No.

Definition

1

SPKR

2

5V

3.2.12 BATTERY

12

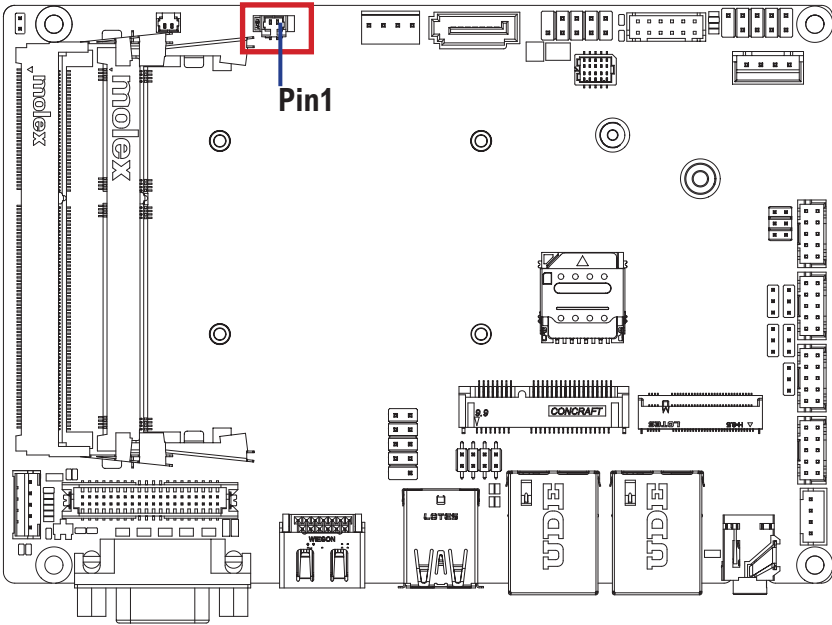

Battery Cable Connector	
2	1

Connector PN	Vendor
85205-0270L	ACES
A1250WV-S-02PC	JOINT-TECH

Pin No.	Definition
1	3.3V
2	GND

3.2.13 SATAPW (SATA power connector)

13

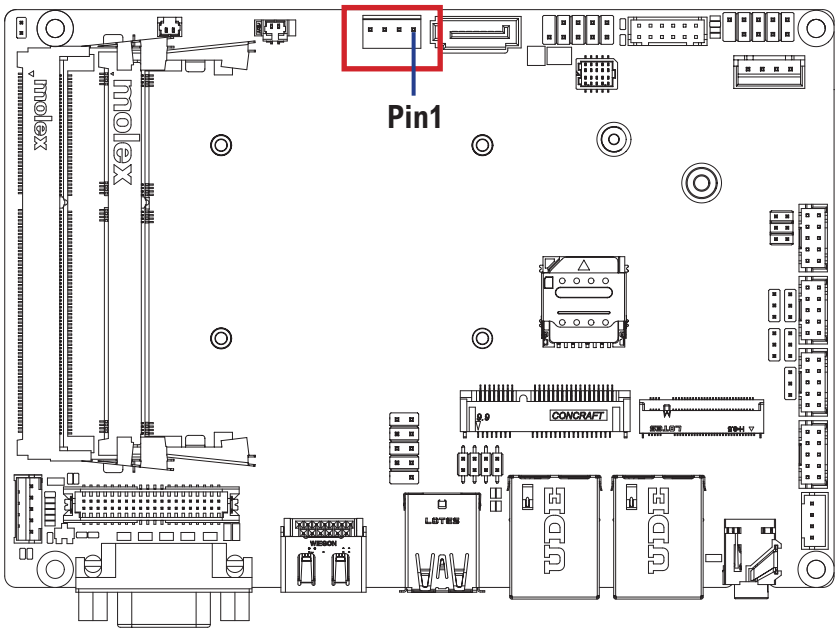

Hard Disk Power Connector



Connector PN

743-81-04TW00

WF04Q2-3BJQ000

Vendor

PINREX

HORNGTONG

Pin No. Definition

Pin No.	Definition
1	12V
2	GND
3	GND
4	5V

3.2.14 SATAIII (SATA 6Gb/S Connector)

14

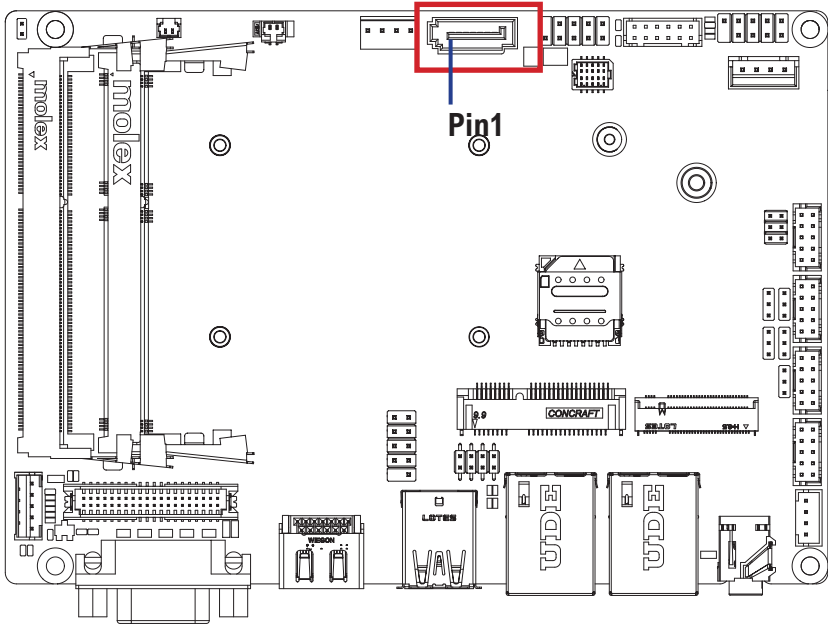

SATA 6GB/S Connector

SATAIII	
Connector PN	Vendor
WAT3M-07A1G3BU4W	WINWIN
ABA-SAT-054-S15	LOTES

Pin No.	Definition
1	GND
2	TXP
3	TXN
4	GND
5	RXN
6	RXP
7	GND

3.2.15 FUSB20_1, FUSB20_2 (USB 2.0 header)

15 18

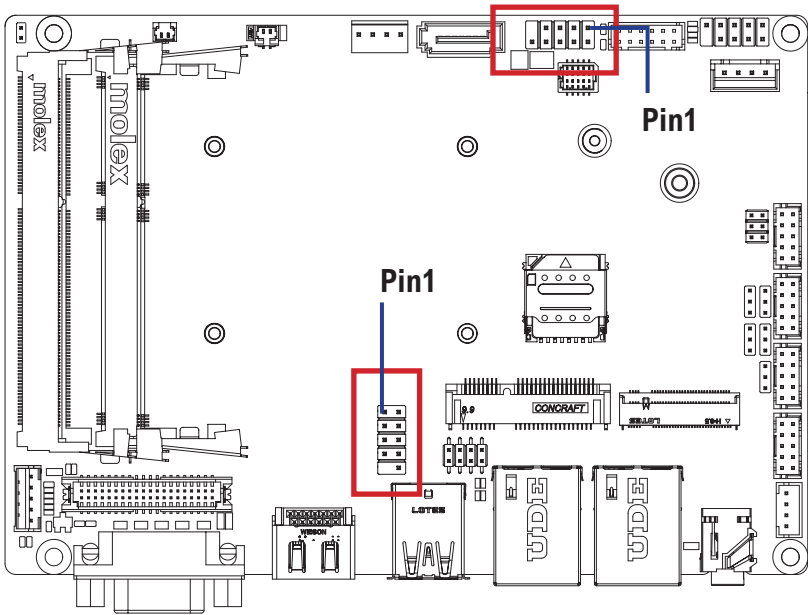

USB 2.0 Header



Connector PN

210-92-05GB04

PH10R53BAZ009

Vendor

PINREX

HORNGTONG

Pin No.

Definition

1	5V
2	5V
3	DX-
4	DY-
5	DX+
6	DY+
7	GND
8	GND
9	No Pin
10	No Connect

3.2.16 GPIO_CNT (General Purpose input/output header)

16

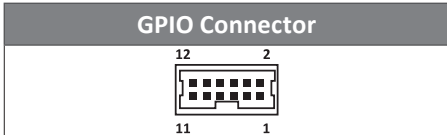
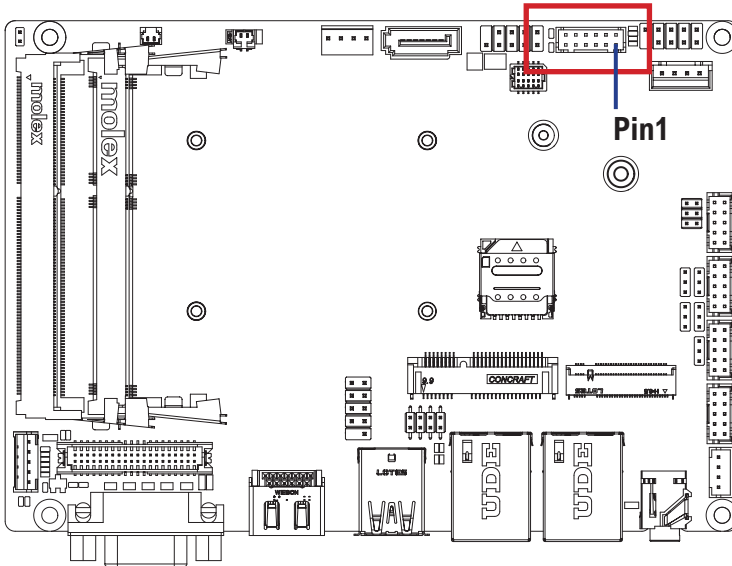

Connector PN	Vendor
725-81-12TW00	PINREX
A2004WV-2X06P46	JOINT-TECH

Pin No.	Definition
1	GPO1
2	GPI1
3	GPO2
4	GPI2
5	GPO3
6	GPI3
7	GPO4
8	GPI4
9	SMB_CLK
10	SMB_DATA
11	5V
12	GND

3.2.17 SYS_PANEL (Front panel header)

17

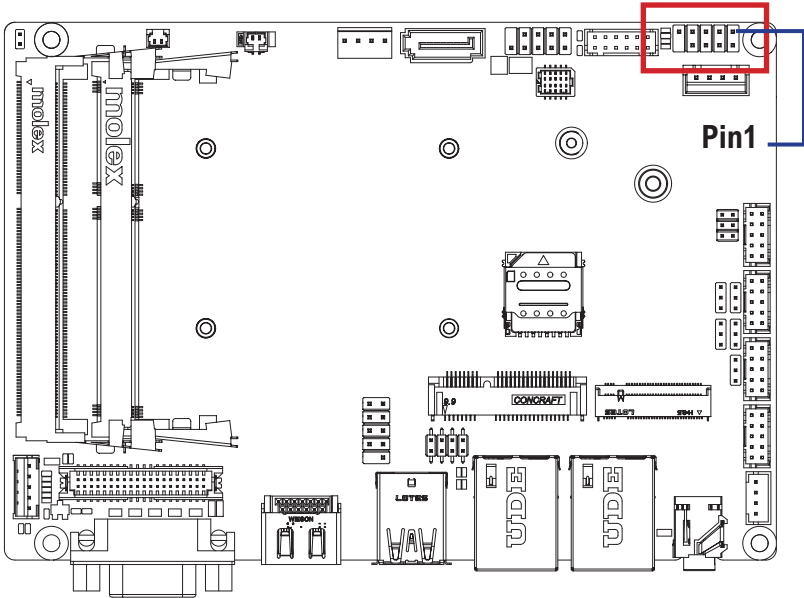

System Panel Header



Connector PN

210-92-05G111

Vendor

PINREX

Pin No.	Definition
1	HDD LED+
2	Power LED+
3	HDD LED-
4	Power LED-
5	GND
6	Power Button+
7	Reset Button
8	Power Button-
9	No Connect
10	No Pin

3.2.18 CLS_CMOS (Clean CMOS jumper)

28

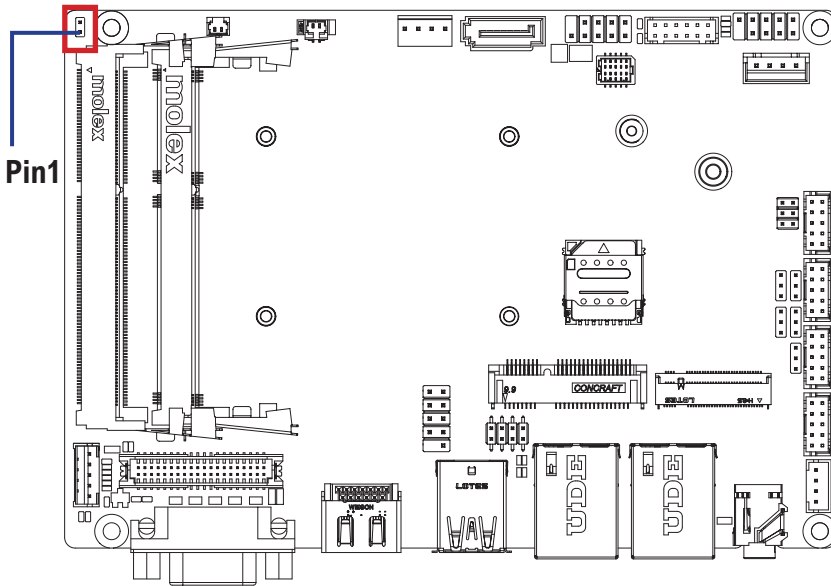

Clear COMS Jumper	
2	1

Pin No.	Definition
	Open: Normal Operation (Default setting)
	Close: Clear COMS data.

Pin No.	Definition
1	Clear CMOS
2	GND

Connector PN	Vendor
210-91-02GB01	PINREX
PH02R23BAZ000	HORNGTONG

Chapter 4

Chapter 4 – BIOS

4.1 Introduction

BIOS (Basic input/output system) provides hardware detailed information and boot-up options, which include firmware to control, set-up and test all hardware settings. Therefore, BIOS is the communication bridge between OS/application software and hardware.

4.1.1 How to Entering into BIOS menu

Once the system is power on, press the key as soon as possible to access into BIOS Setup program.

4.1.2 Function Keys to setup in BIOS Setup program

Function keys	Description
→←	Select Screen
↑↓	Select Item
Enter	Execute command or enter the submenu
+	Increase the numeric value or make changes
—	Decrease the numeric value or make changes
F1	General Help
F2	Previous Values
F3	Load Optimized Defaults Settings
F4	Save changes & Exit the BIOS Setup program
ESC	Exit the BIOS Setup program

4.2 The Main Menu

The main menu shows the basic system information. Use arrow keys to move among the items.

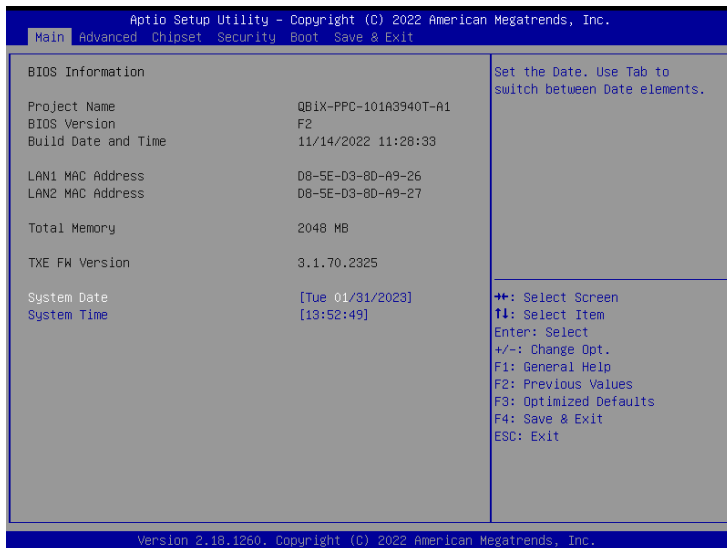

Items	Description
Project Name	Shows Project name information
BIOS Version	Shows the BIOS version of the system
Build Date and Time	Shows the Build Date and Time when the BIOS was created.
LAN1 MAC Address	Shows LAN1 MAC Address information
LAN2 MAC Address	Shows LAN2 MAC Address information
Total Memory	Shows the total memory size of the installed memory
TXE FW version	Shows TXE firmware version
System Date	Set the Date for the system (Format : Week - Month - Day - Year)
System Time	Set the time for the system (Format : Hour - Minute - Second)

4.3 Advanced

The Advanced menu is to configure the functions of hardware settings through submenu. Use arrow keys to move among the items, and press <Enter> to access into the related submenu.

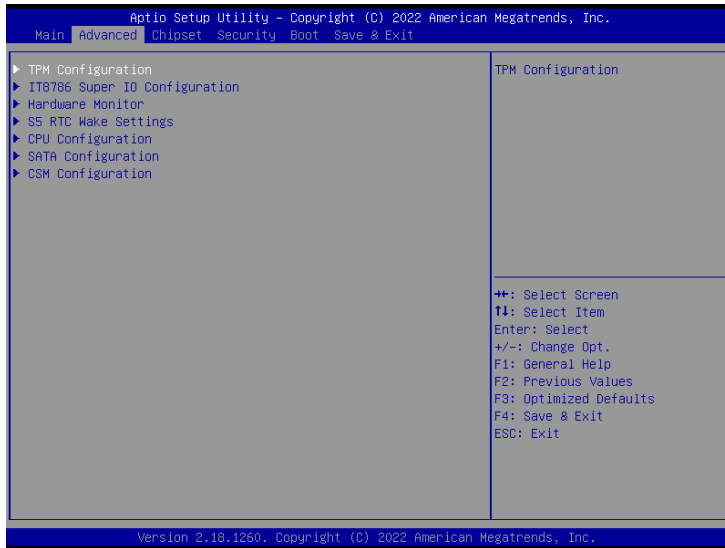

4.3.1 TPM Configuration

Use TPM Configuration submenu to choose TPM interface.



Item	Description
fTPM	Enabled : Enables fTPM function (Default setting) Disabled : Disables fTPM function

Trusted Computing : Shows TPM information, and TPM module configuration setting.



Item	Description
Security Device support	Enabled : Enables TPM feature (Default setting) Disabled : Disables TPM feature
Pending operation	None : No execution will be conducted (Default setting) TPM clear : Set to clear data on TPM

4.3.2 IT8786 Super IO Configuration

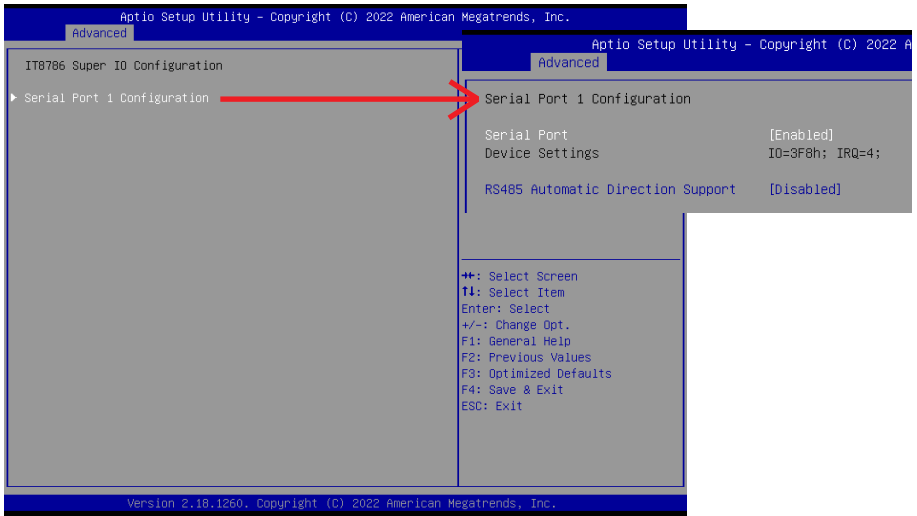

Item	Description
Serial Port 1 Configuration	Press [Enter] to configure advanced items :
	Serial Port : Enabled : Enables allows you to configure the serial port settings Disabled : if Disabled, displays no configuration for the serial port
	Device settings : Display the specified Serial Port base I/O address and IRQ
	RS485 Automatic Direction Support : Disabled : Disables RS485 Automatic Direction support (Default setting) Enabled : Enables RS485 Automatic Direction support

4.3.3 Hardware Monitor

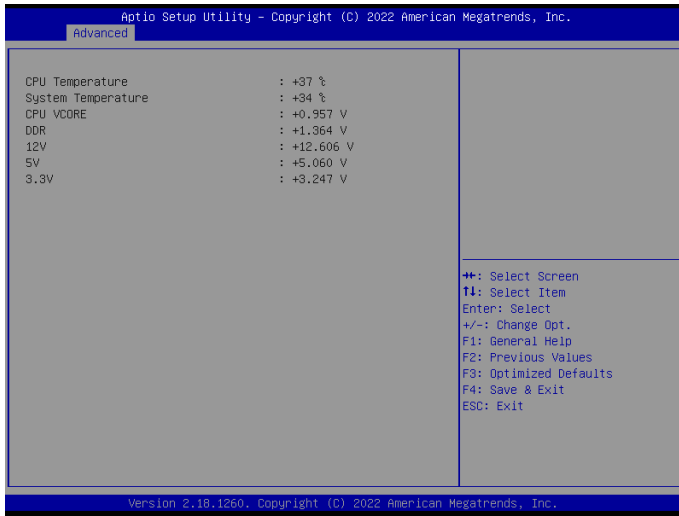

Item	Description
CPU Temperature	Shows current CPU temperature
System Temperature	Shows current system temperature

4.3.4 S5 RTC Wake Settings



Item	Description
<p>Wake system from S5</p>	<p>Enable or Disable System to wake on a specific time. Disabled : Disables system to wake on a specific time (Default setting) Fixed Time : Enables system to wake on a specific time (Format : hr : min : sec)</p>

4.3.5 CPU Configuration

This submenu shows detailed CPU informations.

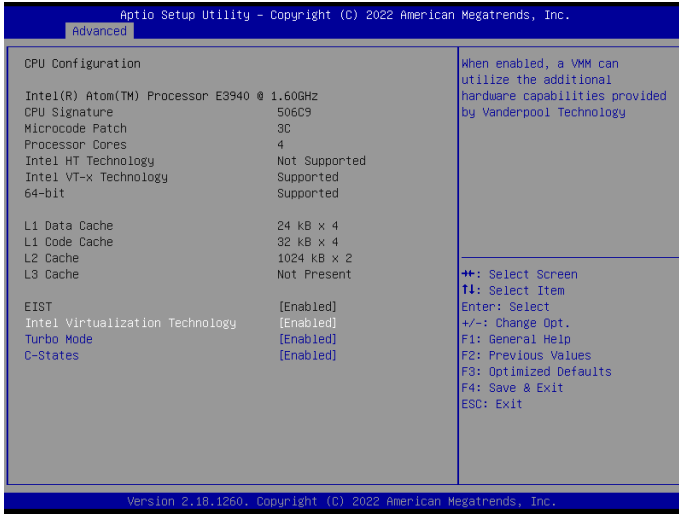

Item	Description
EIST	According to System loading, Enhanced Intel SpeedStep Technology (EIST) will automatically adjust the CPU voltage and core frequency to decrease heat and power consumption for power saving. Enabled : Enables EIST Technology (Default setting) Disabled : Disables EIST Technology
Intel Virtualization Technology	Virtualization enhanced by Intel® Virtualization Technology will allow a platform to run multiple operating systems and applications in independent partitions. With virtualization, one computer system can function as multiple virtual systems. Enabled : Enables Intel Virtualization Technology (Default setting) Disabled : Disables Intel Virtualization Technology
Turbo Mode	Enabled : Enables Turbo Mode (Default setting) Disabled : Disables Turbo Mode
C states	Command CPU to enter into low power consumption mode when CPU is under idle mode. Enabled : Enables C states (Default setting) Disabled : Disables C states

4.3.6 SATA Configuration

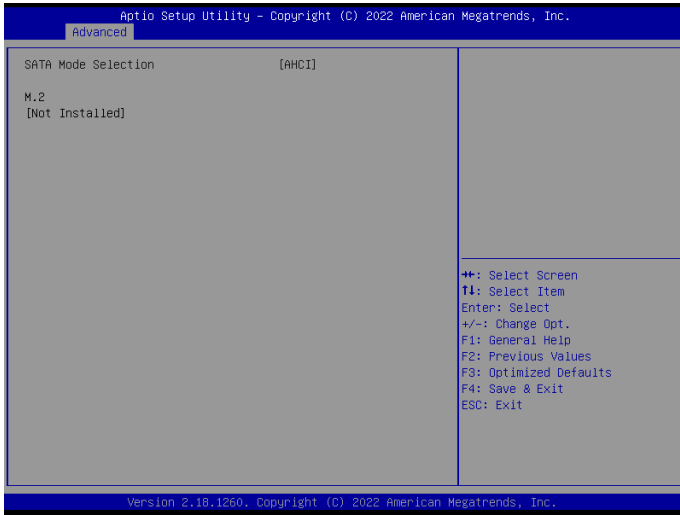

Item	Description
SATA Mode Selection	AHCI mode (Default setting)
M.2	shows M.2 SATA interface SSD information

4.3.7 CSM Configuration

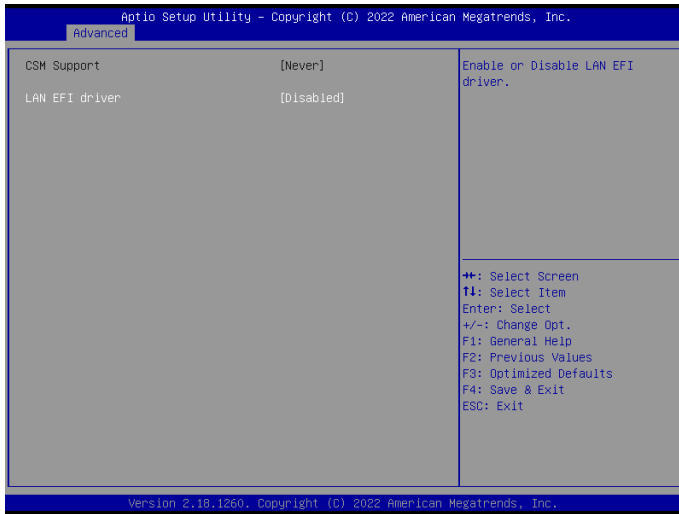

Item	Description
CSM Support	Never (Default setting)
LAN EFI driver	When system is power on, install LAN driver under UEFI mode Disabled : Disables UEFI Network Stack (Default setting) Enabled : Enables UEFI Network Stack

4.4 Chipset

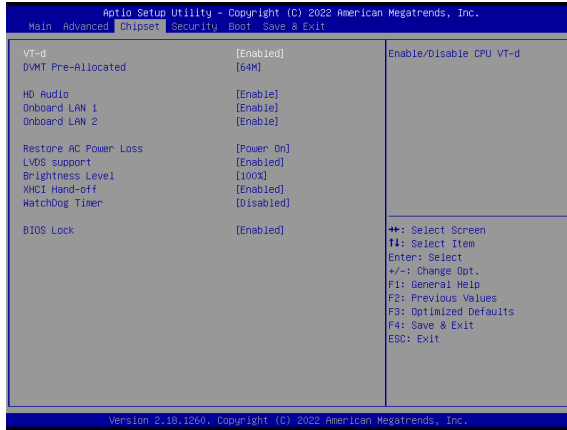

Item	Description
VT-d	Enabled : Enables VT-d function (Default setting) Disabled : Disables VT-d function
DVMT Pre-Allocated	Use DVMT Pre-Allocated to set the amount of system memory which is installed to the integrated graphics processor Option items : 64M(Default setting), 128M, 256M, 512M
HD Audio	Enable/Disable onboard audio controller Enabled : Enables onboard audio controller (Default setting) Disabled : Disables onboard audio controller
Onboard LAN 1 Onboard LAN 2	Enable/Disable onboard LAN controller Enabled : Enables onboard LAN controller (Default setting) Disabled : Disables onboard LAN controller
Restore AC Power Loss	To set which option the system should returns if a sudden power loss occurred Power on : System power on when the power is back (Default setting) Power off : Do not power on when the power is back Last state : Restore the system to the state before power loss occurs
LVDS support	Disabled : Disables LVDS Support Enabled : Enables LVDS Support (Default setting)
Brightness Level	To modified the backlight brightness of the LVDS panel Option items : 10%, 20%, 30%, 40%, 50%, 60%, 70%, 80%, 90%, 100% (Default Setting)
XHCI Hand-off	Enable/Disable XHCI Hand-off function Enabled : Enables XHCI Hand-off function (Default setting) Disabled : Disables XHCI Hand-off function
Watchdog Timer	Enable/Disable Watchdog Timer function Option items : Disabled (Default setting), 15s, 30s, 60s
BIOS Lock	Enable/Disable BIOS Lock function Enabled : Enables BIOS Lock function (Default setting) Disabled : Disables BIOS Lock funtion

4.5 Security

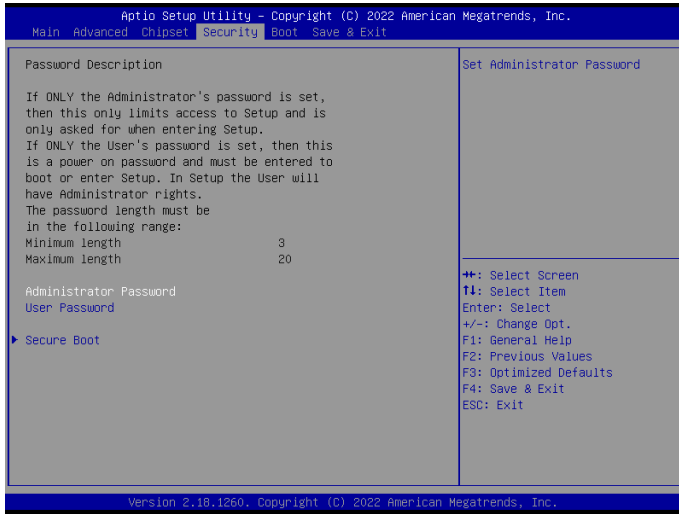

Item	Description
Administrator Password	To set up Administrator's password Minimum length : 3 Maximum length : 20
User Password	To set up User's password Minimum length : 3 Maximum length : 20
Secure Boot	Press <Enter> to configure the advanced items

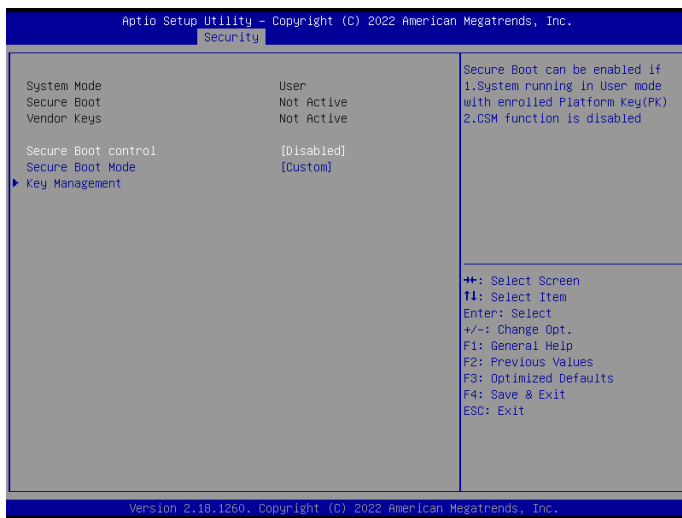

Item	Description
Secure Boot control	Enabled : Enables Secure Boot function Disabled : Disables Secure Boot function (Default setting)
Secure Boot Mode	Standard : Standard mode Custom : Custom mode (Default setting)
Key Management	Enables expert users to modify Secure boot policy variables without full authentication Press <Enter> to configure the advanced items

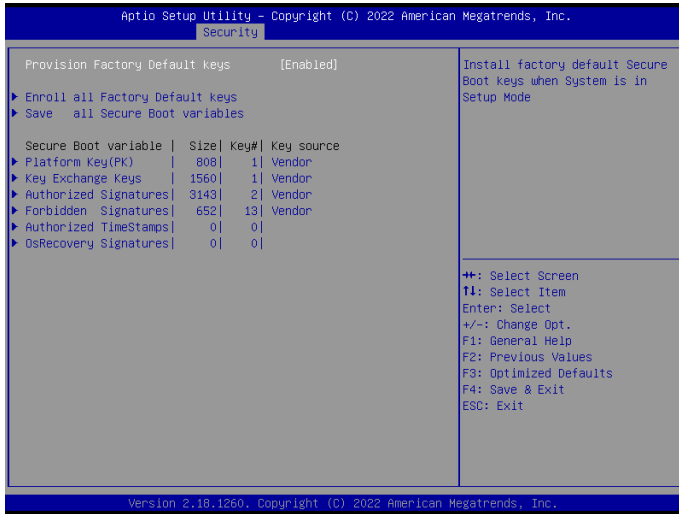

Item	Description
Provision Factory Default Keys	Disabled : Disables Provision Factory Default Keys Enabled : Enables Provision Factory Default Keys (Default setting)
Enroll all Factory Default keys	Force system to user mode - install all factory default keys Yes : Agree to install factory default keys No : Disagree to install factory default keys
Save all Secure Boot Variables	Save NVRAM content of all Secure boot variables to the files in root folder on a target file system device
Platform Key (PK)	These items allows you to enroll factory defaults or load Certificates from a file.
Key Exchange Keys	
Authorized Signatures	
Forbidden Signatures	
Authorized TimeStamps	
OsRecovery Signatures	

4.6 Boot

This Boot menu allows you to set/change system boot options

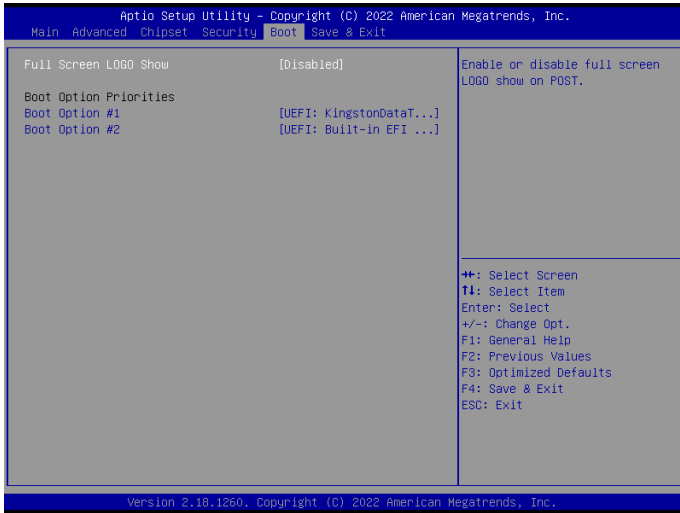

Item	Description
Full Screen LOGO Show	Enable/Disable full screen LOGO show on POST screen Enabled : Enables Full screen LOGO Show on POST screen Disabled : Disables Full screen LOGO Show on POST screen (Default setting)
Boot Option #1 Boot Option #2	Shows the information of the storage that be installed in the system Choose/set the boot priority

4.7 Save & Exit

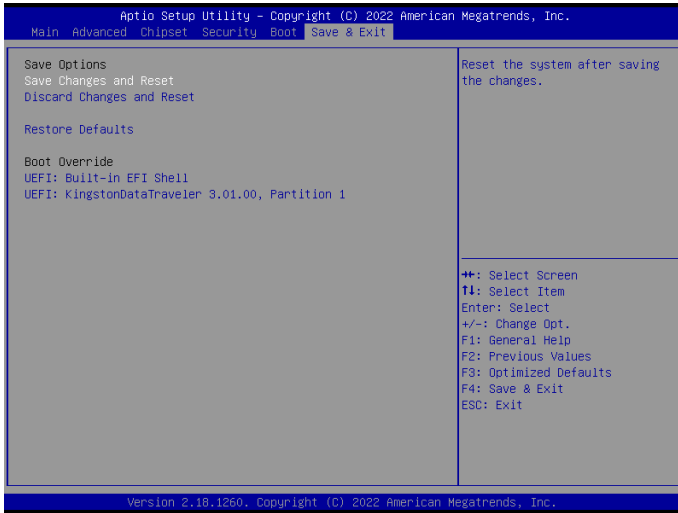

Item	Description
Save Changes and Reset	After configuring all the options that you wish to change, choose this option to save all the changes and reboot the system Yes : Agree to save and reset No : Cancel to save and reset
Discard Changes and Reset	Choose this option to reboot the system without saving any changes Yes : Agree to discard changes and reset No : Cancel to discard changes and reset
Restore Defaults	Restore/Load default values for all the setup options Yes : Agree to load optimized defaults No : Cancel to load optimized defaults
Boot Override	Boot override