

NViS1482 GPIO Design Proposal

3/21/2022

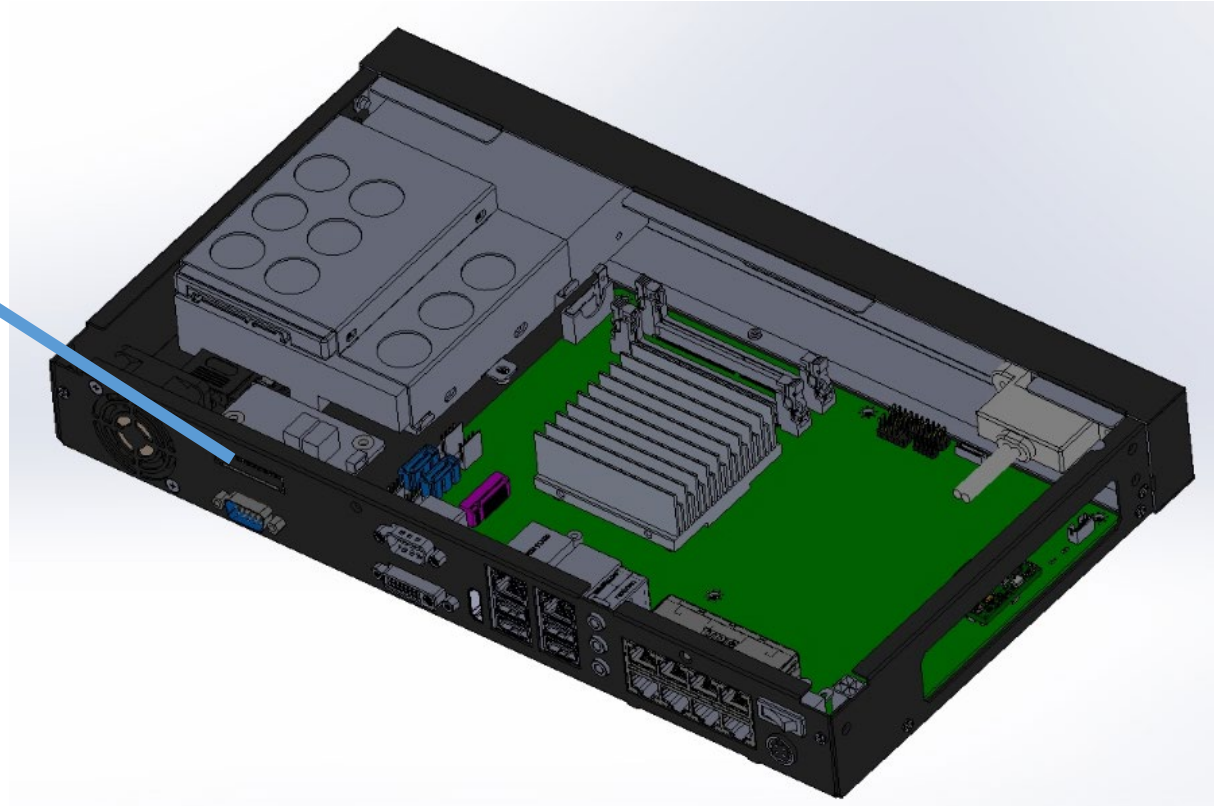

NViS1482 4-IN/2-OUT GPIO Design

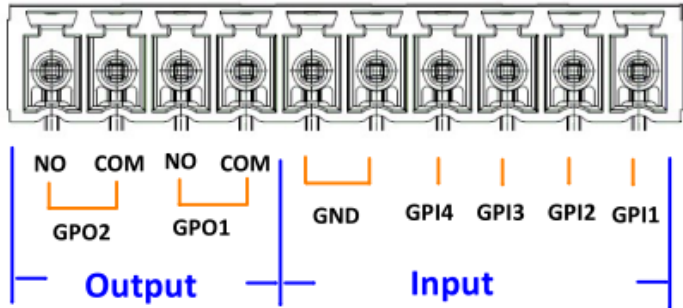
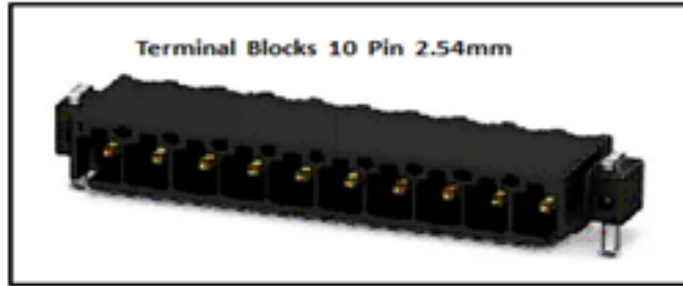

NViS1482 4-IN/2-OUT Isolated GPIO Design

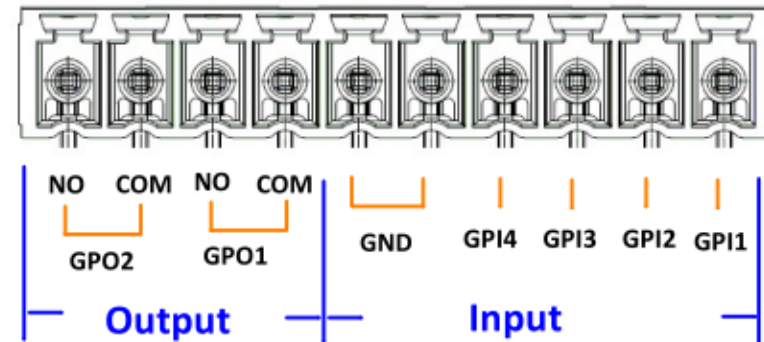
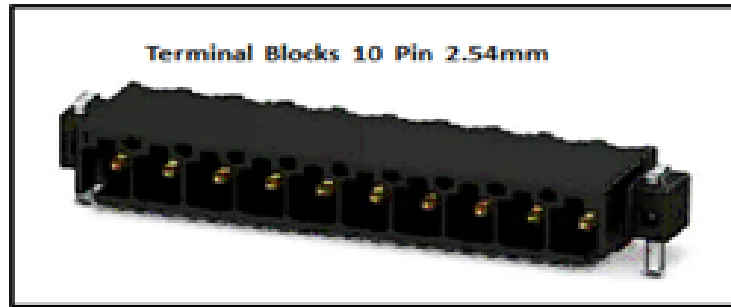

NViS1482 4-IN/2-OUT Isolated GPIO Design Application



ISO GPIO 4in_2out Block Diagram

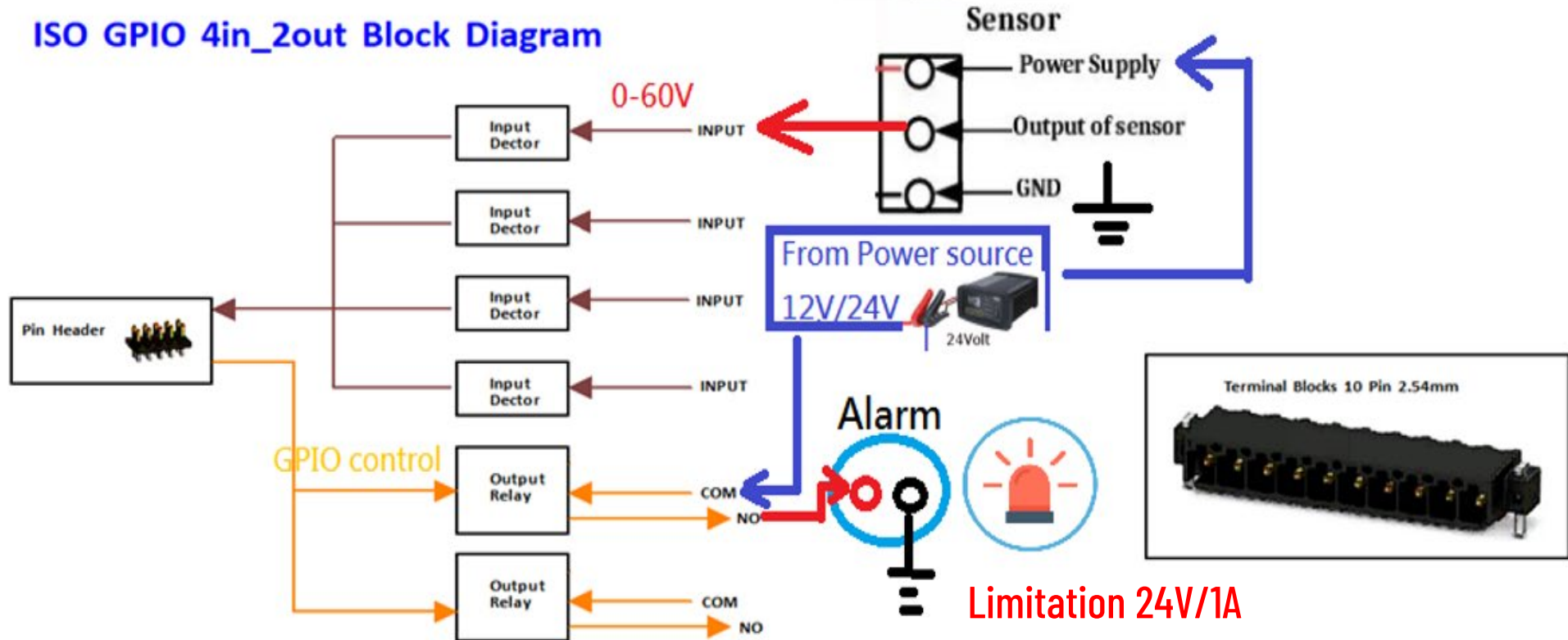

NViS1482 4-IN/2-OUT SDK Control (Windows)



GPI (4IN)

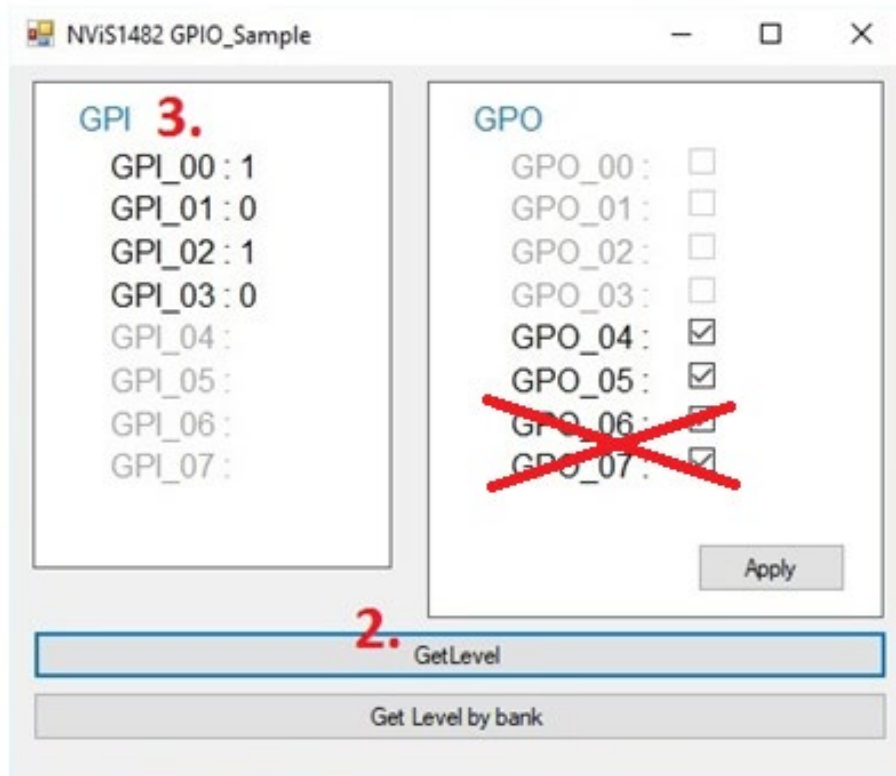

GPO (2OUT)

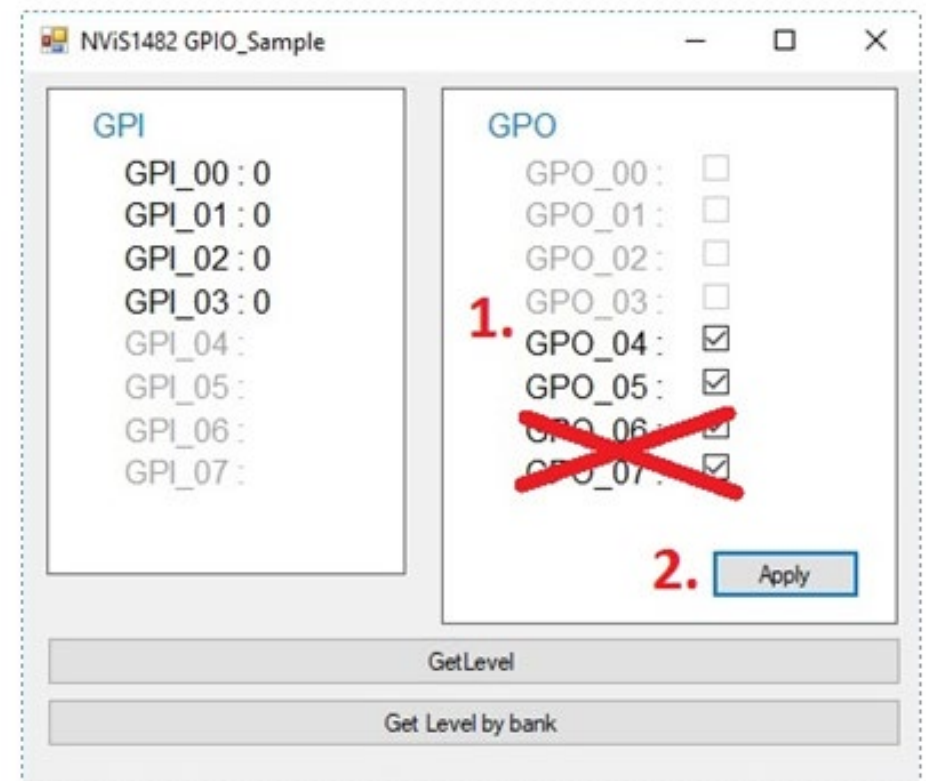

**Thank
You**