

EC500-SD

Q170



► Features

- Supports DDR4 SODIMM up to 32GB
- Three independent displays: 1 VGA + 1 DVI + 1 HDMI/DP
- Compact and cost-effective solution
- Rich I/O connectivity: 2 GbE, 4 COM, 4 USB 3.0, 2 USB 2.0
- 2 Mini PCIe slots support mSATA and Wi-Fi modules



► Panel

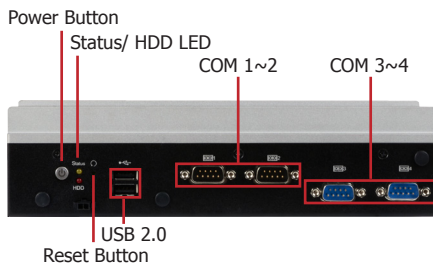

Front View

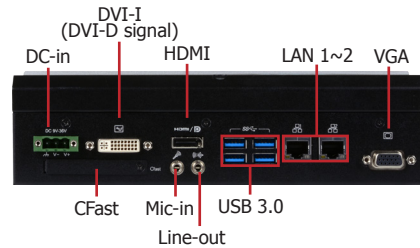

Rear View

► Dimensions

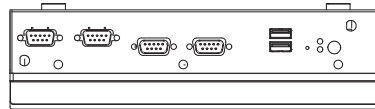

Front View

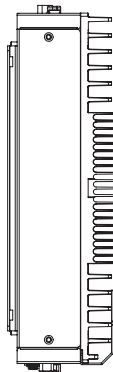

Left View

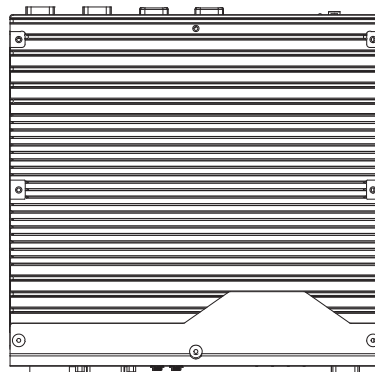

Rear View

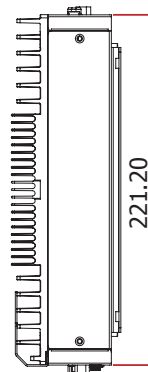

Right View

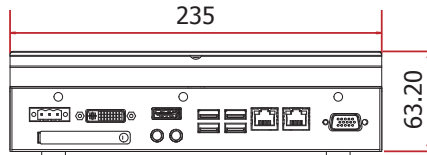

► Specifications

SYSTEM	Processor	6th Generation Intel® Core™ Processors, LGA 1151 Socket Intel® Core™ i7-6700TE, Quad Core, 8M Cache, 2.4GHz (3.4GHz), 35W Intel® Core™ i5-6500TE, Quad Core, 6M Cache, 2.3GHz (3.3GHz), 35W Intel® Core™ i3-6100TE, Dual Core, 4M Cache, 2.7GHz, 35W	
	Chipset	Intel® Q170 Chipset	
	Memory	Two 260-pin SODIMM up to 32GB Dual Channel DDR4 1866/2133MHz	
	BIOS	Insyde SPI 128Mbit	
GRAPHICS	Controller	Intel® HD Gen 9 Graphics	
	Feature	OpenGL 5.0, DirectX 12, OpenCL 2.1 HW Decode: AVC/H.264, MPEG2, VC1/WMV9, JPEG/MJPEG, HEVC/H265, VP8, VP9 HW Encode: MPEG2, AVC/H264, JPEG, HEVC/H265, VP8, VP9	
	Display	1 x VGA 1 x DVI (DVI-D signal) 1 x HDMI/DP (DP available upon request)	VGA: resolution up to 1920x1200 @ 60Hz DVI: resolution up to 2560x1600 @ 60Hz HDMI: resolution up to 4096x2160 @ 24Hz or 2560x1600 @ 60Hz DP: resolution up to 4096x2304 @ 60Hz
	Triple Displays	VGA + DVI (DVI-D signal) + HDMI/DP (DP available upon request)	
STORAGE	Internal	1 x 2.5" SATA 3.0 Drive Bay	
EXPANSION	Interface	1 x Full-size Mini PCIe (PCIe/USB) 1 x Half-size Mini PCIe (USB/mSATA) 1 x CFast Card Slot	
ETHERNET	Controller	1 x Intel® I211AT PCIe (10/100/1000Mbps) 1 x Intel® I219V with iAMT11.0 PCIe (10/100/1000Mbps) (only Core i7/i5 supports iAMT)	
LED	Indicators	1 x Power LED 1 x HDD LED	
FRONT I/O	Serial	2 x RS-232/422/485 (DB-9) (RS-232 with power) 2 x RS-232/422/485 (DB-9)	
	USB	2 x USB 2.0 (type A)	
	Buttons	1 x Power Button 1 x Reset Button	
REAR I/O	Ethernet	2 x GbE (RJ-45)	
	USB	4 x USB 3.0 (type A)	
	Display	1 x VGA 1 x DVI (DVI-D signal) 1 x HDMI/DP (DP available upon request)	
	Audio	1 x Line-out 1 x Mic-in	
WATCHDOG TIMER	Output & Interval	System Reset, Programmable via Software from 1 to 255 Seconds	
POWER	Type	Wide Range 9~36V	
	Connector	3-pole Terminal Block	
OS SUPPORT		Windows 7 (32/64-bit) Windows 10 Windows 8.1 (64-bit)	
MECHANISM	Construction	Aluminum + SGCC	
	Mounting	Wall Mount	
	Dimensions (W x H x D)	235mm x 63.2mm x 221.2mm (W x H x D)	
	Weight	TBD	
ENVIRONMENT	Operating Temperature	0 to 45°C	
	Storage Temperature	-20 to 85°C	
	Relative Humidity	5 to 95% RH (non-condensing)	
STANDARDS AND CERTIFICATIONS	Shock	Half sine wave 3G, 11ms, 3 shock per axis	
	Vibration	IEC68-2-64	

► Wall Mounting

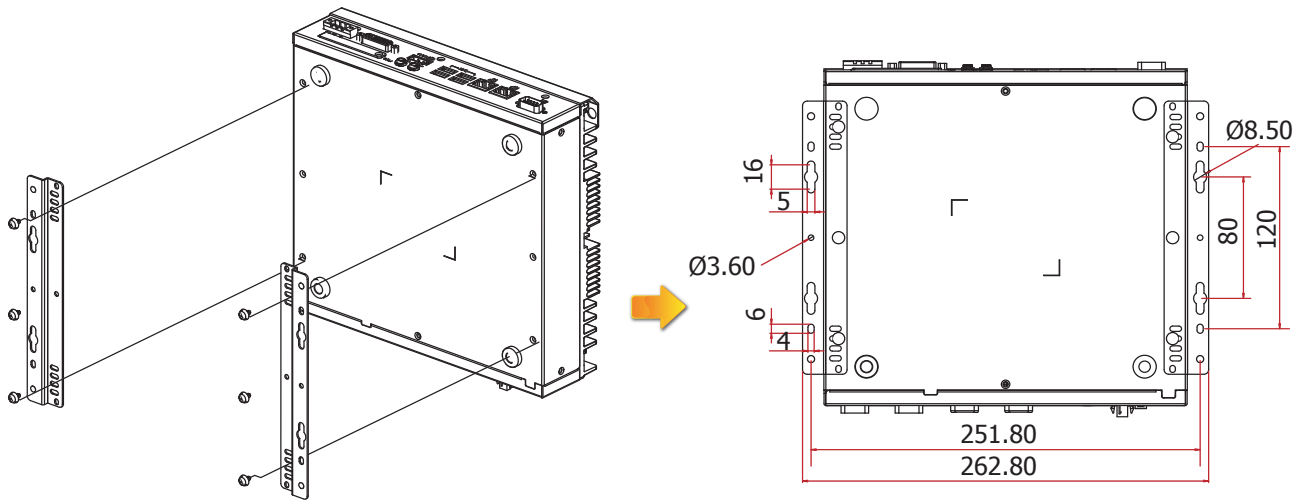

► Ordering Information

Model Name	Part Number	Description
EC500-SD4061	750-EC5000-100G	Fanless, Q170, 1 VGA, 1 DVI, 1 HDMI, 2 LAN, 4 COM, 6 USB, RoHS

► Optional Items

Optional Items	Part Number	Description
CPU	143-102402-500G	Intel® Core™ i7-6700TE, Quad Core, 8M Cache, 2.4GHz (3.4GHz), 35W, RoHS
	143-102303-500G	Intel® Core™ i5-6500TE, Quad Core, 6M Cache, 2.3GHz (3.3GHz), 35W, RoHS
	143-102701-500G	Intel® Core™ i3-6100TE, Dual Core, 4M Cache, 2.7GHz, 35W, RoHS
Memory	785-RSOD416G	SODIMM, DDR4 Module, 16GB, RoHS
	785-RSOD48G	SODIMM, DDR4 Module, 8GB, RoHS
	785-RSOD44G	SODIMM, DDR4 Module, 4GB, RoHS
mSATA	785-MS128GMF	mSATA Card, 128GB MLC, RoHS
	785-MS64GMF	mSATA Card, 64GB MLC, RoHS
	785-MS32GMF	mSATA Card, 32GB MLC, RoHS
	785-MS16GMF	mSATA Card, 16GB MLC, RoHS
	785-MS08GMF	mSATA Card, 8GB MLC, RoHS
	785-MS04GMF	mSATA Card, 4GB MLC, RoHS
Wi-Fi	761-110091-000G	Wi-Fi Kit, RoHS
Power Cord	785-PWRD	Power Cord, Standards (USA/EUR/CH), 1.8m, RoHS
Power Adapter	671-110002-100G	100W, 12V, Level 6, RoHS
	671-110003-100G	120W, 19V, Level 6, RoHS
Wall Mount	761-EC5410-000G	Wall Mount Kit, RoHS

► Packing List

• 1 EC500 system unit
• 1 Quick Installation Guide
• 1 CD disk includes:
- Drivers / Manual