

NEX716VL2G Series

User Manual

This manual serves all NEX716VL2G models.

Copyright

This publication, including all photographs, illustrations and software, is protected under international copyright laws, with all rights reserved. No part of this manual may be reproduced, copied, translated or transmitted in any form or by any means without the prior written consent from NEXCOM International Co., Ltd.

Version 1.0

Copyright 2004

Disclaimer

The information in this document is subject to change without prior notice and does not represent commitment from NEXCOM International Co., LTD. However, users may update their knowledge of any product in use by constantly checking its manual posted on our website: <http://www.nexcom.com>. NEXCOM shall not be liable for direct, indirect, special, incidental, or consequential damages arising out of the use of any product, nor for any infringements upon the rights of third parties, which may result from such use. Any implied warranties of merchantability of fitness for any particular purpose is also disclaimed.

Acknowledgements

The NEX716VL2G is a trademark of NEXCOM international CO., LTD. All other product names mentioned herein are registered trademarks of their respective owners.

Regulatory Compliance Statements

This section provides the FCC compliance statement for Class A devices and describes how to keep the system CE compliant.

FEDERAL COMMUNICATIONS COMMISSION (FCC) FOR CLASS A DEVICES

This equipment has been tested and verified to comply with the limits for a Class A digital device, pursuant to Part 15 of FCC Rules. These limits are designed to provide reasonable protection against harmful interference when the equipment is operated in a commercial environment. This equipment generates, uses, and can radiate radio frequency energy and, if not installed and used in accordance with the instructions, may cause harmful interference to radio communications. Operation of this equipment in a residential area (domestic environment) is likely to cause harmful interference, in which case the user will be required to correct the interference (take adequate measures) at their own expense.

CE CERTIFICATION

The product(s) described in this manual complies with all applicable European Union (CE) directives if it has a CE marking. For computer systems to remain CE compliant, only CE-compliant parts may be used. Maintaining CE compliance also requires proper cable and cabling techniques.

WARNINGS

Read and adhere to all warnings, cautions, and notices in this guide and the documentation supplied with the chassis, power supply, and accessory modules. If the instructions for the chassis and power supply are inconsistent with these instructions or the instructions for accessory modules, contact the supplier to find out how you can ensure that your computer meets safety and regulatory requirements.

CAUTION

Electrostatic discharge (ESD) can damage NEX components. Do the described procedures only at an ESD workstation. If no such station is available, you can provide some ESD protection by wearing an antistatic wrist strap and attaching it to a metal part of the computer chassis.

Safety Information

Before installing and using the NEX716VL2G, note the following precautions:

- ◆ Read all instructions carefully.
- ◆ Do not place the unit on an unstable surface, cart, or stand.
- ◆ Follow all warnings and cautions in this manual.
- ◆ When replacing parts, ensure that your service technician uses parts specified by the manufacturer.
- ◆ Avoid using the system near water, in direct sunlight, or near a hearing device.

Table of Contents

Preface	1
Copyright	1
Disclaimer	1
Acknowledgements	1
Regulatory Compliance Statements	1
FEDERAL COMMUNICATIONS COMMISSION (FCC) FOR CLASS A DEVICES	1
CE CERTIFICATION	1
WARNINGS	2
CAUTION	2
Safety Information	2
Table of Contents	3
Chapter 1 General Information	5
1.1 Feature	6
1.2 Specifications	6
1.3 Board Layout	10
1.4 Board Dimensions	11
Chapter 2 Jumper Setting	12
2.1 Before You Begin	13
2.2 Precautions	13
2.3 Setting Jumpers	14
2.4 Location of Jumpers	15
2.5 Function of Jumpers	16
2.6 Pin Definitions of Connectors	17
Chapter 3 Expansion Capabilities	26
3.1 System Memory	27
3.2 Installing DIMM	28
Chapter 4 Award BIOS Setup	30
4.1 About the BIOS	31
4.2 When to Run BIOS	31
4.3 Entering Setup	32
4.4 The Main Menu	32
4.5 Getting Help	33
4.6 Control Keys	34
4.7 Standard CMOS Features	35
4.8 Advanced BIOS Features	38
4.9 Advanced Chipset Features	41

4.10 Integrated Peripherals	43
4.11 Power Management Setup	45
4.12 PnP/PCI Configurations	48
4.13 PC Health Status	49
4.14 Load Fail-Safe Defaults	49
4.15 Load Optimized Defaults	50
4.16 Set Supervisor/User Password	50
4.17 Save & Exit Setup	50
4.18 Exit Without Saving	50
Chapter 5 Driver Installation	51
5.1 Installation CD	52
5.2 Installing Drivers for NEX716VL2G series	52
5.3 Installing Audio Driver	53
5.4 Installing Intel Application Accelerator Driver.....	54
5.5 Installing Intel Chipset Driver.....	56
5.6 Installing LAN Driver.....	57
5.7 Installing USB Driver.....	60
5.8 Installing VGA Driver.....	63
Appendix A Watchdog Timer	65
Appendix B GPIO Programming	68

Chapter 1

General Information

1.1 Feature

The NEX716VL2G is a member of NEXCOM's Pentium 4 based Embedded CPU Board computer family. The features of this model are as follows:

- ◆ Support **Intel® Pentium® 4/Celeron Processor** with 400/533MHz FSB, CPU speed up to 3.06GHz
- ◆ Support **Intel® Pentium® 4-M Processor** with 400MHz FSB, CPU speed up to 2.5GHz
- ◆ Max. 2GB channel DDR 266/333SDRAM memory support, DIMM × 2
- ◆ **Intel® 82845GV** Chipsets
- ◆ **Intel® 82562EM 10/100 Ethernet Controller and Intel® 82541GI Gigabit Ethernet Controller**
- ◆ PCI slot x 4, ISA x 3
- ◆ Standard ATX form factor

1.2 Specifications

CPU Support

- ◆ Single mPGA478 ZIF socket
- ◆ **Support Intel® Pentium® 4 Processor:** 533MHz FSB, speed up to 3.06GHz with Hyper-Threading Technology and **Intel® NetBurst Microarchitecture** support
- ◆ **Support Intel® Pentium® 4-M Processor:** 400MHz FSB, speed up to 2.50GHz with **Intel® NetBurst Microarchitecture** support
- ◆ 256/512K L2 cache on die depends on CPU

Main Memory

- ◆ 184-pin DDR DIMM x 2, support max. memory up to 2GB (DDR266/333)
- ◆ Support single-sided/double-sided
- ◆ Support unbuffered, non-ECC DIMMs only
- ◆ Does not support the stacking type memory DIMMs and does not support the DIMMs with double-sided x 16 DDR SDRAM Chip

BIOS

- ◆ Award System BIOS
 - ◆ Plug & Play support
 - ◆ Advanced Power Management support
 - ◆ Advanced Configuration & Power Interface support
 - ◆ Jumperless for CPU FSB
- W Support Power on after power failure

- ◆ 4M bits flash ROM

Chipset

- ◆ Intel® 82845GV chipset
- ◆ Intel® 82801DB (ICH4)
- ◆ Firmware Hub (FWH)
- ◆ PCI V2.2 compliant

On-Chip I/O (ICH4)

- ◆ Onboard USB port x 6 (connector x 4 + pin header x 2)
- ◆ FWH interface
- ◆ LPC interface
- ◆ AC'97 2.2 with Audio Codec
- ◆ PCI 2.2 interface
- ◆ Integrated System Management Controller
- ◆ Integrated LAN Controller
- ◆ Ultra ATA 100/66/33 support, 40-pin connector x 2, 5V 2-pin power connector x 2
- ◆ DOC (Disk on Chip) support

Onboard LAN

- ◆ Intel® 82562EM 10/100 Ethernet Controller x 1
- ◆ Intel® 82541GI Gigabit Ethernet Controller x 1 (Intel LAN driver can not support Windows NT4.0)
- ◆ Compliant with IEEE 802.3, IEEE 802.3u, IEEE 802.3x, IEEE 802.3ab
- ◆ Drivers support: Windows® XP/NT/2000, Linux
- ◆ RJ45 with LED connector x 2
- ◆ 2 x pin header for extended LAN

Onboard VGA

- ◆ Intel 82845GV chipset integrated with graphics controller
- ◆ 64MB VGA shared memory
- ◆ 15-pin CRT connector x 1

Onboard I/O

- ◆ ITE IT8712F and FINTEK F81216D (for 4 x com) super I/O onboard
- ◆ Serial port x 4 (COM 2 with 422/485 as an option), 9-pin D-sub connector x 1, 9-pin header x 3
- ◆ Parallel port x 1, Bi-directional, EPP/ECP support, 25-pin D-sub connector x 1

- ◆ On chip enhanced IDE x 2, Ultra ATA33/66/100 support, total 4 E.IDE devices support, 40-pin connector x 2
- ◆ PS/2 keyboard/mouse Mini-DIN connector x 2
- ◆ GPIO (4-in/4-out)
- ◆ Reset SW: on-board 2-pin header
- ◆ SM bus: on-board 2-pin header
- ◆ USB 2.0 x 6
- ◆ 5-pin IrDA pin header x 1

Onboard Audio

- ◆ AC'97 codec: Realtek ALC655
- ◆ Phone jack x 3 on rear side (Line in x 1, Line out x 1, Mic In x 1)
- ◆ Onboard CD-in x 1 and Aux-in header

Onboard Slot

- ◆ PCI-ISA Bridge ITE 8888
- ◆ PCI slot x 4
- ◆ ISA slot x 3

Onboard RTC

- ◆ On-chip real time clock with battery back up

System Monitor

- ◆ System monitor controller derived from ITE IT8712F super I/O
- ◆ 8 voltage (for +1.5v, +3.3V, +5V, -5V, +12V, Vcore, +5V standby, and +3.3V standby)
- ◆ 3 fan speed(one for CPU and 2 for system)
- ◆ 2 temperature (for CPU and external system)

Back Panel

- ◆ PS2 connector x 2 for keyboard/mouse
- ◆ USB 2.0 port x 4
- ◆ RJ45 with LED connector x 2
- ◆ 9 pin D-type connector x 1 (for SIO)
- ◆ 25 pin D-type connector x 1 (for PIO)
- ◆ Standard audio connector (Line out, Line in, Mic in)

Watchdog Timer

- ◆ 1~255 seconds time-out intervals
- ◆ Watchdog timeout can be programmable by software from 1,2,4,8,16,32.....255 seconds

Dimensions

- ◆ ATX form factor: 305mm(L) x 244mm (W) (12" x 9.6")

Power Input

- ◆ ATX power connector x 1

Power Requirements

Voltage	Maxmum
+3.3V	0.65A
+5V	1.60A
+12V	5.10A
5VSTBY	0.3A

Remarks: Add-on card and external device are not included.

Environments

- ◆ Operating temperatures: 0°C to 60°C
- ◆ Storage temperatures: -20°C to 80°C
- ◆ Relative humidity: 10% to 90% (Non-condensing)

Certification

- ◆ CE
- ◆ FCC

Ordering Information:

NEX716VL2G:

Intel® Pentium® 4/Pentium® 4-Mobile/Celeron Processor Server Board with dual LAN (Intel® 82541GI Gigabit Ethernet + Intel® 82562EM 10/100 Ethernet controllers)

1.3 Board Layout

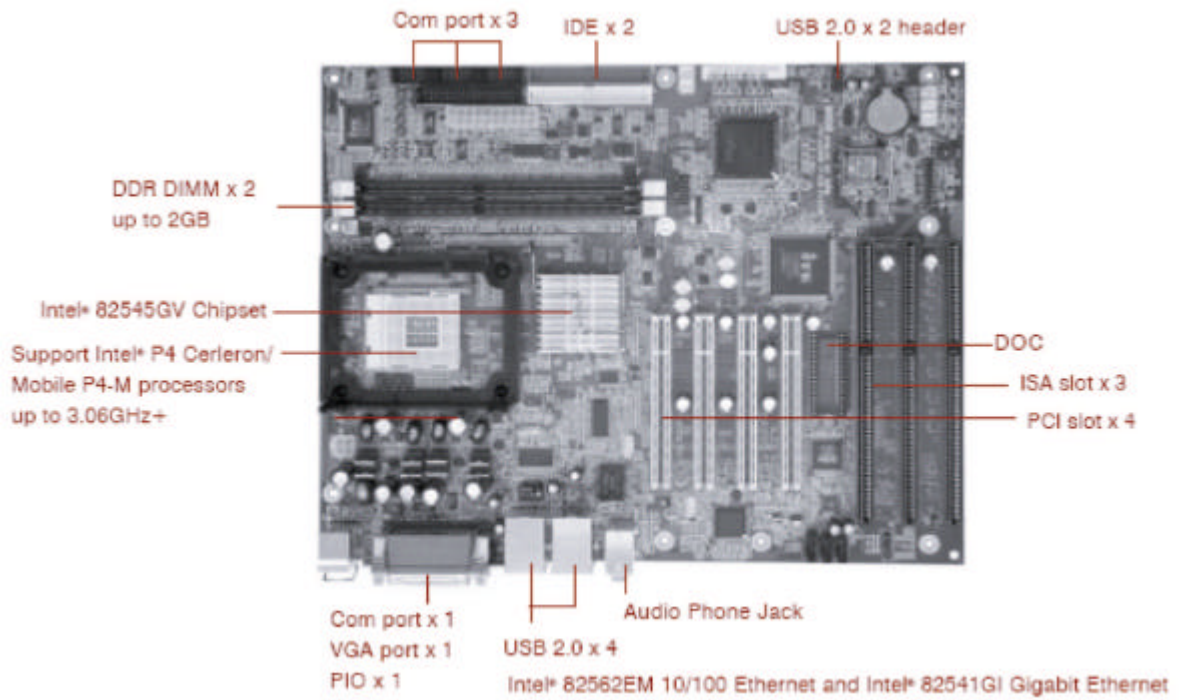

Figure 1.1 : Birdeye's View of NEX716VL2G

1.4 Board Dimensions

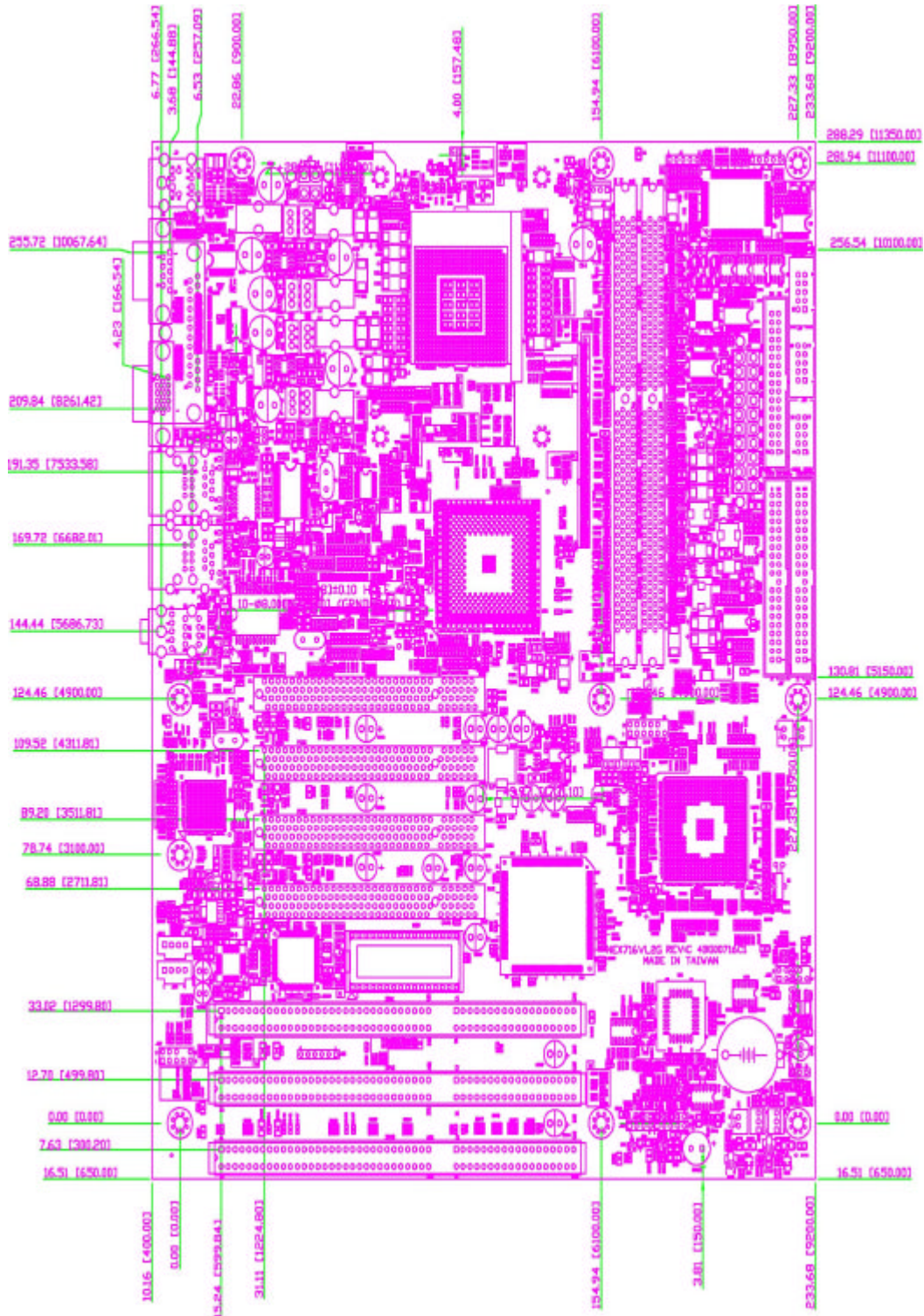

Figure 1.2 : Board Dimensions

Chapter 2 Jumper Setting

This chapter of the User's Manual describes how to set jumpers.

Note: The procedures that follow are generic for all of the NEX716VL2G series.

2.1 Before You Begin

Ensure you have a stable, clean working environment. Dust and dirt can get into components and cause a malfunction. Use containers to keep small components separated.

Adequate lighting and proper tools can prevent you from accidentally damaging the internal components. Most of the procedures that follow require only a few simple tools, including the following:

- ◆ A Philips screwdriver
- ◆ A flat-tipped screwdriver
- ◆ A set of jewelers Screwdrivers
- ◆ A grounding strap
- ◆ An anti-static pad

Using your fingers can disconnect most of the connections. It is recommended that you do not use needle-nosed pliers to disconnect connections as these can damage the soft metal or plastic parts of the connectors.

Before working on internal components, make sure that the power is off. Ground yourself before touching any internal components, by touching a metal object. Static electricity can damage many of the electronic components. Humid environment tend to have less static electricity than dry environments. A grounding strap is warranted whenever danger of static electricity exists.

2.2 Precautions

Computer components and electronic circuit boards can be damaged by discharges of static electricity. Working on the computers that are still connected to a power supply can be extremely dangerous. Follow the guidelines below to avoid damage to your computer or yourself:

- ◆ Always disconnect the unit from the power outlet whenever you are working inside the case.
- ◆ If possible, wear a grounded wrist strap when you are working inside the computer case. Alternatively, discharge any static electricity by touching the bare metal chassis of the unit case, or the bare metal body of any other grounded appliance.
- ◆ Hold electronic circuit boards (such as the NEX716VL2G board) by the edges only. Do not touch the components on the board unless it is necessary to do so. Don't flex or stress the circuit board.
- ◆ Leave all components inside the static-proof packaging that they shipped with until they are ready for installation.
- ◆ Use correct screws and do not over tighten screws.

2.3 Setting Jumpers

A jumper is the simplest kind of electric switch. It consists of two metal pins and a cap. When setting the jumpers, ensure that the jumper caps are placed on the correct pins. When the jumper cap is placed on both pins, the jumper is **SHORT**. If you remove the jumper cap, or place the jumper cap on just one pin, the jumper is **OPEN**. Please see the following illustrations

<p>The illustrations on the right show a 2-pin jumper. When the jumper cap is placed on both pins, the jumper is SHORT. If you remove the jumper cap, or place the jumper cap on just one pin, the jumper is OPEN.</p>		
<p>These illustrations show a 3-pin jumper. Pins 1 and 2 are SHORT.</p>		

Table 2-1 : Setting Jumpers

2.4 Location of Jumpers

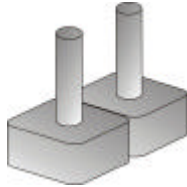
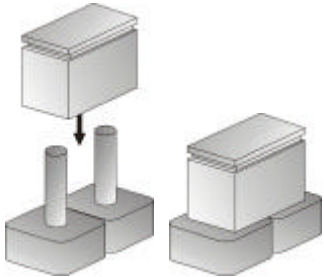
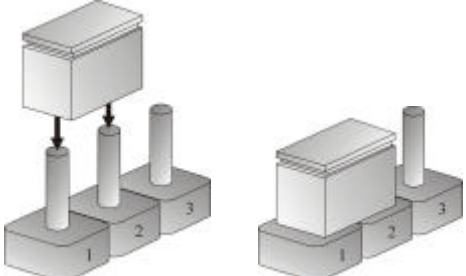
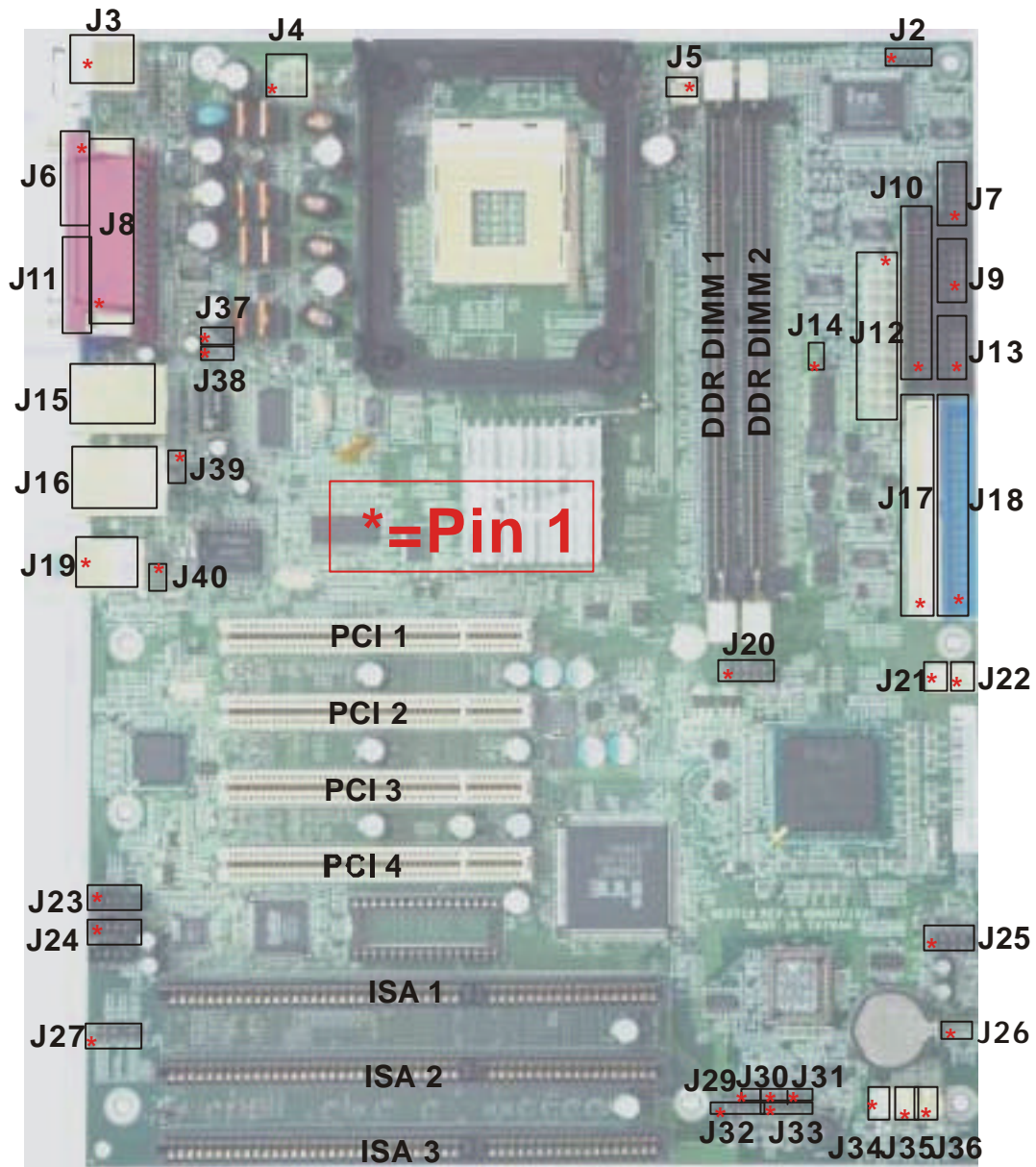

Figure 2-1 : Jumper Location

2.5 Function of Jumpers

User can use jumpers to set configuration options. The table below defines function of each jumper:

Pin No.	Description
J2	IrDA , 5x1 Pin Header
J3	PS2 Keyboard / Mouse, Mini Din connector
J4	ATX Power Connector, 2x2 Pin ,12V Input only
J5	CPU Fan Connector
J6	COM1, DSUB 9 Pin Connector
J7	COM2, 5X2 Pin Box Header
J8	LPT1 (Parallel Port), DSUB 25 Pin Connector
J9	COM3, 5X2 Pin Box Header
J10	FDD,17x2 Box Header
J11	CRT out, HDS DSUB 15 Pin Connector
J12	ATX Power Connector, 10x2 pin
J13	COM4, 5x2 Pin Box Header
J14	IDE Access LED Header, 2x1 Pin Header
J15	LAN1 + USB1/USB2, One Port RJ45 + Two Port USB Stack up Connector
J16	LAN2 + USB3/USB4, One Port RJ45 + Two Port USB Stack up Connector
J17	IDE Channel 2, 20x2 Pin Header
J18	IDE Channel 1, 20x2 Pin Header
J19	Line in/Head Phone out/MIC in, Three Audio Phone Jack Stack up Connector
J20	GIPO Port, 8 Pin In/Out, 6x2 Pin Header
J21	5V Power Header for Disk On Module, JST2.5mm 2 Pin
J22	5V Power Header for Disk On Module, JST2.5mm 2 Pin
J23	CD In, 4x1 Shrouded Header
J24	AUX In, 4x1 Shrouded Header
J25	USB5/USB6, 5x2 Pin Header
J26	CMOS Setup Clear. 3x1 Pin Header (1-2 Short for normal, 2-3 Short for CMOS Clear)
J27	Audio Front I/O Connector, 5x2 Pin Header
J28	CPLD Programmer Header, 6x1 Pin Header
J29	Reset Button, 2x1 Pin Header
J30	ATX Power On Button, 2x1 Pin Header
J31	CPU Type Selection (P4 or P4M), 3x1 Pin Header (2-3 short for P4 ,1-2 Short for P4M)
J32	System Speaker Out, 4x1 Pin Header
J33	System Power On LED / Keyboard Lock, 5x1 Pin Header
J34	SM-BUS Header, JST 2.5mm 2Pin
J35	System Fan1 Connector
J36	System Fan2 Connector
J37	LAN1 Linking Speed LED, 2x1 Pin Header
J38	LAN1 Link/Active LED 2x1 Pin Header
J39	LAN2 Linking Speed LED 2x1 Pin Header
J40	LAN2 Link/Active LED, 2x1 Pin Header

2.6 Pin Definition of Connectors

J3: PS2 Keyboard/Mouse, Mini Din connector
Keyboard:

Pin No.	Description	Pin No.	Description
1	Keyboard Data	2	NC
3	Ground	4	+5V
5	Keyboard Clock	6	NC

PS2 Mouse:

Pin No.	Description	Pin No.	Description
1	Mouse Data	2	NC
3	Ground	4	+5V
5	Mouse Clock	6	NC

J6: COM1, DSUB 9 Pin Connector

Pin No.	Description	Pin No.	Description
1	Data Carrier Detect (DCD)	6	Data Set Ready (DSR)
2	Receive Data (RXD)	7	Request To Send (RTS)
3	Transmit Data (TXD)	8	Clear To Send (CTS)
4	Data Terminal Ready (DTR)	9	Ring Indicator (RI)
5	GND		

J11: CRT out, HDS DSUB 15 Pin Connector

Pin No.	Description	Pin No.	Description	Pin No.	Description
1	Red	6	Ground	11	NC
2	Green	7	Ground	12	DDC Data
3	Blue	8	Ground	13	Horizontal Sync
4	NC	9	+5V	14	Vertical Sync
5	Ground	10	Ground	15	DDC Clock

J15: LAN1 + USB1/USB2, One Port RJ45 + Two Port USB Stack up Connector
LAN1:

Pin No.	Description
1	TX+
2	TX-
3	RX+
4	NC
5	NC
6	RX-
7	NC
8	NC

USB1/USB2:

Pin No.	Description
1	+5V
2	USB DATA-
3	USB DATA+
4	Ground

J16: LAN2 + USB3/USB4, One Port RJ45 + Two Port USB Stack up Connector
LAN2:

Pin No.	Description
1	TX0+
2	TX0-
3	TX1+
4	TX2+
5	TX2-
6	TX1-
7	TX3P
8	TX3-

USB3/USB4:

Pin No.	Description
1	+5V
2	USB DATA-
3	USB DATA+
4	Ground

J19: Line in/Head Phone out/MIC in, Three Audio Phone Jack Stack up Connector

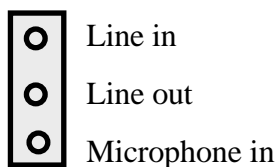

J2: IrDA, 5x1 Pin Header

Pin No.	Description
1	+5V
2	NC
3	Ir RX
4	Ground
5	Ir TX

J4: ATX Power Connector, 2x2 Pin, 12V Input only

Pin No.	Description	Pin No.	Description
3	+12V	1	Ground
4	+12V	2	Ground

J12: ATX Power Connector, 10x2 pin

Pin No.	Description	Pin No.	Description
11	+3.3V	1	+3.3V
12	-12V	2	+3.3V
13	Ground	3	Ground
14	PS-ON	4	+5V
15	Ground	5	Ground
16	Ground	6	+5V
17	Ground	7	Ground
18	-5V	8	Power Good
19	+5V	9	+5VSB
20	+5V	10	+12V

J5/J35/J36: CPU Fan/ System Fan1/System Fan2 Connector

Pin No.	Description
1	Ground
2	Programmable Fan Power
3	Fan Speed sensor

J7/J9/J13: COM2(RS232 Mode)/COM3/COM4, 5X2 Pin Box Header

Pin No.	Description	Pin No.	Description
1	DCD	6	DSR
2	RXD	7	RTS
3	TXD	8	CTS
4	DTR	9	RI
5	Ground	10	NC

J7: COM2 RS422 Mode

Pin No.	Description	Pin No.	Description
1	TXD-	6	RTS-
2	TXD+	7	RTS+
3	RXD+	8	CTS+
4	RXD-	9	CTS-
5	Ground	10	NC

J7: COM2 RS485 Mode

Pin No.	Description	Pin No.	Description
1	TXD-/RXD-	6	NA
2	TXD+/RXT+	7	NA
3	NA	8	NA
4	NA	9	NA
5	Ground	10	NC

J8: LPT1 (Parallel Port), DSUB 25 Pin Connector.

Pin No.	Description	Pin No.	Description
1	Line Print Strobe	14	Auto Feed
2	Parallel Data 0	15	Error
3	Parallel Data 1	16	Initialize
4	Parallel Data 2	17	Select
5	Parallel Data 3	18	Ground
6	Parallel Data 4	19	Ground
7	Parallel Data 5	20	Ground
8	Parallel Data 6	21	Ground
9	Parallel Data 7	22	Ground
10	Acknowledge	23	Ground
11	Busy	24	Ground
12	Paper empty	25	Ground
13	Select	26	NC

J10: FDD,17x2 Box Header.

Pin No.	Description	Pin No.	Description
1	Ground	2	DENSEL#
3	Ground	4	NC
5	Ground	6	NC
7	Ground	8	INDEX#
9	Ground	10	MOTEA#
11	Ground	12	DRVB#
13	Ground	14	DRVA#
15	Ground	16	MOTEB#
17	Ground	18	DIR#
19	Ground	20	STEP#
21	Ground	22	WDATA#
23	Ground	24	WGATE#
25	Ground	26	TK00#
27	Ground	28	WPT#
29	NC	30	RDATA#
31	Ground	32	SIDE1#
33	NC	34	DSKCHG#

J14: IDE Access LED Header, 2x1 Pin Header.

Pin No.	1	2
Description	LED+	LED-

J17/J18 : IDE Channel 1/2 , 20x2 Pin Header.

Pin No.	Description	Pin No.	Description
1	Reset #	2	Ground
3	Data 7	4	Data 8
5	Data 6	6	Data 9
7	Data 5	8	Data 10
9	Data 4	10	Data 11
11	Data 3	12	Data 12
13	Data 2	14	Data 13
15	Data 1	16	Data 14
17	Data 0	18	Data 15
19	Ground	20	NC
21	DMA REQ	22	Ground
23	IOW#	24	Ground
25	IOR#	26	Ground
27	IOCHRDY	28	Pull Down
29	DMA ACK#	30	Ground
31	Interrupt 14	32	NC
33	Disk Address 1	34	DMA66 Detect
35	Disk Address 0	36	Disk Address 2
37	HDCCS1	38	HDC CS3
39	HDD Active Led	40	Ground

J21/J22 : 5V Power Header for Disk On Module, JST2.5mm 2 Pin.

Pin No.	1	2
Description	+5V	GND

J20: GIPO Port, 8 Pin In/Out, 6x2 Pin Header.

Pin No.	Description	Pin No.	Description
1	GPI1 (GPIO36)note	2	GPO1 (GPIO40)note
3	GPI2 (GPIO37)note	4	GPO2 (GPIO41)note
5	GPI3 (GPIO38)note	6	GPO3 (GPIO42)note
7	GPI4 (GPIO39)note	8	GPO4 (GPIO43)note
9	+5V	10	Ground
11	NC		

Note:ICH4PinDefinition

J23: CD In, 4x1 Shrouded Header.

Pin No.	Description
1	CD In Lift
2	CD GND
3	CD GND
4	CD In Right

J24: AUX In, 4x1 Shrouded Header.

Pin No.	Description
1	AUX In Lift
2	AUX GND
3	AUX GND
4	AUX In Right

J27: Audio Front I/O Connector, 5x2 Pin Header.

Pin No.	Description	Pin No.	Description
1	MIC-	2	GND
3	MIC+	4	+5V
5	Line Out Right	6	Line In Right
7	NC	8	KEY
9	Line Out Left	10	Line In Left

J25: USB5/USB6, 5x2 Pin Header.

Pin No.	Description	Pin No.	Description
1	+5V	6	+5V
2	USB5-	7	USB6-
3	USB5+	8	USB6+
4	GND	9	GND
5	NC		

J34: SM-BUS Header, JST 2.5mm 2Pin.

Pin No.	1	2
Description	DATA	CLOCK

J32: System Speaker Out, 4x1 Pin Header.

Pin No.	Description
1	Speaker +
2	Ground
3	Ground
4	Speaker-

J33: System Power On LED / Keyboard Lock , 5x1 Pin Header.

Pin No.	Description
1	LED+
2	NC
3	LED-
4	KEY LOCK
5	Ground

PCI1/PCI2/PCI3/PCI4 : PCI Slot

Pin No.	Description	Pin No.	Description	Pin No.	Description	Pin No.	Description
A1	Test Reset#	A32	AD16	B1	-12V	B32	AD17
A2	+12V	A33	+3.3V	B2	Test Clock	B33	CMD/Byte Enable2#
A3	Test Mode	A34	Frame#	B3	Ground	B34	Ground
A4	Test Input	A35	Ground	B4	NC	B35	Initiator Ready#
A5	+5V	A36	Target Ready#	B5	+5V	B36	+3.3V
A6	Interrupt A#	A37	Ground	B6	+5V	B37	Device Select#
A7	Interrupt C#	A38	Stop#	B7	Interrupt B#	B38	Ground
A8	+5V	A39	+3.3V	B8	Interrupt D#	B39	Lock#
A9	NC	A40	Snoop Done	B9	NC	B40	Parity Error#
A10	+5V	A41	Snoop Backoff#	B10	NC	B41	+3.3V
A11	NC	A42	Ground	B11	NC	B42	System Error#
A12	Ground	A43	Parity	B12	Ground	B43	+3.3V
A13	Ground	A44	AD15	B13	Ground	B44	CMD/Byte Enable1#
A14	3.3VAUX	A45	+3.3V	B14	Secondary Clock	B45	AD14
A15	Reset#	A46	AD13	B15	Ground	B46	Ground
A16	+5V	A47	AD11	B16	Clock	B47	AD12
A17	Grant (GNT#)	A48	Ground	B17	Ground	B48	AD10
A18	Ground	A49	AD9	B18	Request#	B49	Ground
A19	PME#	A50	Keyway	B19	+5V	B50	Keyway
A20	AD30	A51	Keyway	B20	AD31	B51	Keyway
A21	+3.3V	A52	CMD/Byte Enable0#	B21	AD29	B52	AD8
A22	AD28	A53	+3.3V	B22	Ground	B53	AD7

A23	AD26	A54	AD6	B23	AD27	B54	+3.3V
A24	Ground	A55	AD4	B24	AD25	B55	AD5
A25	AD24	A56	Ground	B25	+3.3V	B56	AD3
A26	ID Select	A57	AD2	B26	CMD/Byte Enable3#	B57	Ground
A27	+3.3V	A58	AD0	B27	AD23	B58	AD1
A28	AD22	A59	+5V	B28	Ground	B59	+5V
A29	AD20	A60	Request 64Bits#	B29	AD21	B60	Acknowledge 64Bits#
A30	Ground	A61	+5V	B30	AD19	B61	+5V
A31	AD18	A62	+5V	B31	+3.3V	B62	+5V

J31/J33/J42 : ISA Slot

Pin No.	Description	Pin No.	Description	Pin No.	Description	Pin No.	Description
A1	IOCHK#	B1	Ground	C1	SBHE#	D1	MEMCS16#
A2	SD0	B2	RSTDRV	C2	LA23	D2	IOCS16#
A3	SD1	B3	+5V	C3	LA22	D3	IRQ10
A4	SD2	B4	-5V	C4	LA21	D4	IRQ11
A5	SD3	B5	IRQ9	C5	LA20	D5	IRQ12
A6	SD4	B6	DRQ2	C6	SA19	D6	IRQ15
A7	SD5	B7	-12V	C7	SA18	D7	IRQ14
A8	SD6	B8	ZEROWS#	C8	SA17	D8	DACK0#
A9	SD7	B9	+12V	C9	MEMR#	D9	DRQ0
A10	IOCHRDY	B10	Ground	C10	MEMW#	D10	DACK5#
A11	AEN	B11	SMEMW#	C11	SD8	D11	DRQ5
A12	SA19	B12	SMEMR#	C12	SD9	D12	DACK6#
A13	SA18	B13	IOW#	C13	SD10	D13	DRQ6
A14	SA17	B14	IOR#	C14	SD11	D14	DACK7#
A15	SA16	B15	DACK3#	C15	SD12	D15	DRQ7
A16	SA15	B16	DRQ3#	C16	SD13	D16	+5V
A17	SA14	B17	DACK1#	C17	SD14	D17	MASTER#
A18	SA13	B18	DRQ1#	C18	SD15	D18	Ground

A19	SA12	B19	REFSESH#
A20	SA11	B20	BUS CLK
A21	SA10	B21	IRQ7
A22	SA9	B22	IRQ6
A23	SA8	B23	IRQ5
A24	SA7	B24	IRQ4
A25	SA6	B25	IRQ3
A26	SA5	B26	DACK2#
A27	SA4	B27	TC
A28	SA3	B28	BALE
A29	SA2	B29	+5V
A30	SA1	B30	14.318Mhz
A31	SA0	B31	Ground

Chapter 3

Expansion Capabilities

3.1 System Memory

Your system memory is provided by DIMMs (Dual In-Line Memory Modules) on the CPU board. The board contains two memory banks: Bank 0 and 1 corresponding to connectors DIMM1, DIMM2.

The table below shows possible DIMM Configurations for the memory banks. Please note that the NEX716VL2G series supports Double Data Rate RAM (DDR266/333). Configurations using different brands of memory modules are not recommended.

DIMM1	DIMM2	Total Memory
128 MB	Empty	128 MB
Empty	128 MB	128 MB
128 MB	128 MB	256 MB
256 MB	Empty	256 MB
Empty	256 MB	256 MB
256 MB	256 MB	512 MB
512 MB	Empty	512 MB
Empty	512 MB	512 MB
512 MB	512 MB	1024 MB
1024 MB	Empty	1024 MB
Empty	1024 MB	1024 MB
1024 MB	1024 MB	2048 MB

Table 3-1: DIMM Configurations of the NEX716VL2G

3.2 Installing DIMM

To install DIMM

1. Make sure the two handles of the DIMM sockets are in the “open” position, i.e. the handles stay outward.

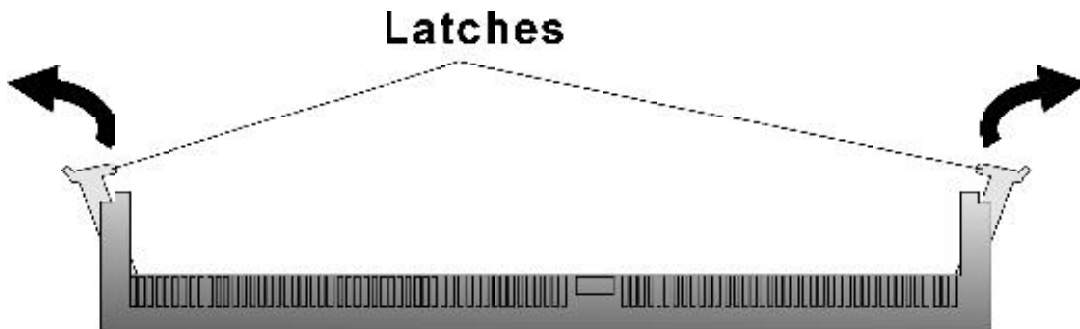

Figure3-1: How to Install DIMM (1)

2. Slowly slide the DIMM modules along the plastic guides in the both ends of the socket.

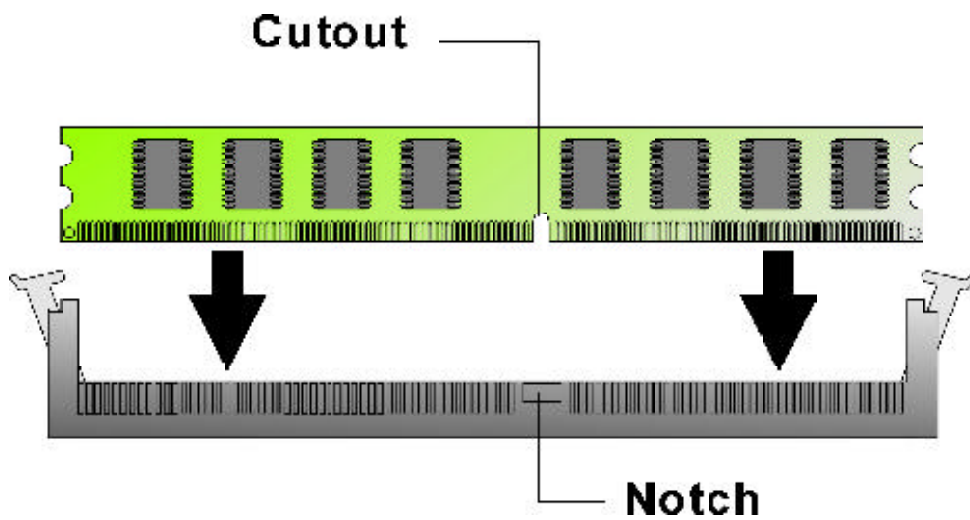

Figure 3-2: How to Install DIMM (2)

3. Then press the DIMM module down right into the socket, until a click is heard. That means the two handles automatically locked the memory modules into the right position of the DIMM socket.

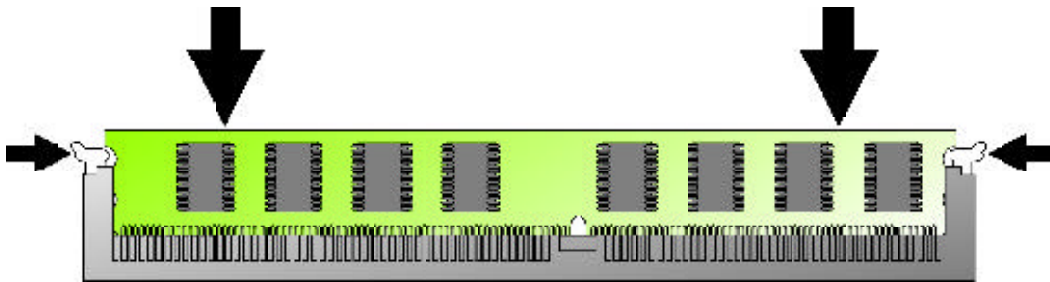

Figure 3-3: How to Install DIMM (3)

4. To take away the memory module, just push the both handles outward, the memory module will be ejected by the mechanism in the socket.

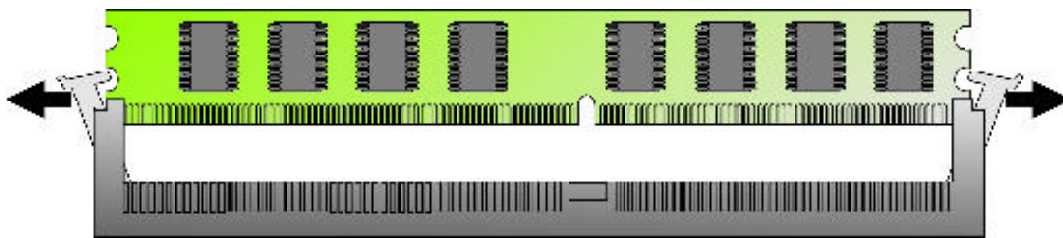

Figure 3-4: How to Install DIMM (4)

Chapter 4 Award BIOS Setup

This chapter explains how to use the BIOS Setup program for the NEX716VL2G. The current BIOS setup pictures in the chapter is for reference only, which may change by the BIOS modification in the future. User can download any major updated items or reversion from NEXCOM web site <http://www.nexcom.com.tw>. If any unclear message occurs, please contact NEXCOM customer service representative for help or log onto <http://www.nexcom.com.tw/contact/contact.htm>.

4.1 About the BIOS

The BIOS (Basic Input and Output System) Setup program is a menu driven utility that enables you to make changes to the system configuration and tailor your system to suit your individual work needs. It is a ROM-based configuration utility that displays the system's configuration status and provides you with a tool to set system parameters. These parameters are stored in non-volatile battery-backed-up CMOS RAM that saves this information even when the power is turned off. When the system is turned back on, the system is configured with the values found in CMOS.

With easy-to-use pull down menus, you can configure such items as:

- ◆ Hard drives, diskette drives, and peripherals
- ◆ Video display type and display options
- ◆ Password protection from unauthorized use
- ◆ Power management features

The settings made in the Setup program intimately affect how the computer performs. It is important, therefore, first to try to understand all the Setup options, and second, to make settings appropriate for the way you use the computer.

4.2 When to Run BIOS

This program should be executed under the following conditions:

- ◆ When changing the system configuration
- ◆ When a configuration error is detected by the system and you are prompted to make changes to the Setup program
- ◆ When resetting the system clock
- ◆ When setting the CPU clock speed so that it automatically runs either fast or slow
- ◆ When redefining the communication ports to prevent any conflicts
- ◆ When making changes to the Power Management configuration
- ◆ When changing the password or making other changes to the security setup

Normally, CMOS setup is needed when the system hardware is not consistent with the information contained in the CMOS RAM, whenever the CMOS RAM has lost power, or the system features need to be changed.

4.3 Entering Setup

When the system is powered on, the BIOS will enter the Power-On Self Test (POST) routines. These routines perform various diagnostic checks; if an error is encountered, the error will be reported in one of two different ways:

- ◆ If the error occurs before the display device is initialized, a series of beeps will be transmitted.
- ◆ If the error occurs after the display device is initialized, the screen will display the error message.

Powering on the computer and immediately pressing allows you to enter Setup. Another way to enter Setup is to power on the computer and wait for the following message during the POST:

**TO ENTER SETUP BEFORE BOOT
PRESS <CTRL-ALT-ESC> OR KEY**

Press the key or press the <Ctrl>, <Alt>, and <Esc> keys to enter Setup:

4.4 The Main Menu

Once you enter Award BIOS CMOS Setup Utility, the Main Menu (Figure 1) will appear on the screen. The main menu allows you to select from ten setup functions and two exit choices. Use arrow keys to select among the items and press <Enter> to accept or enter the sub-menu.

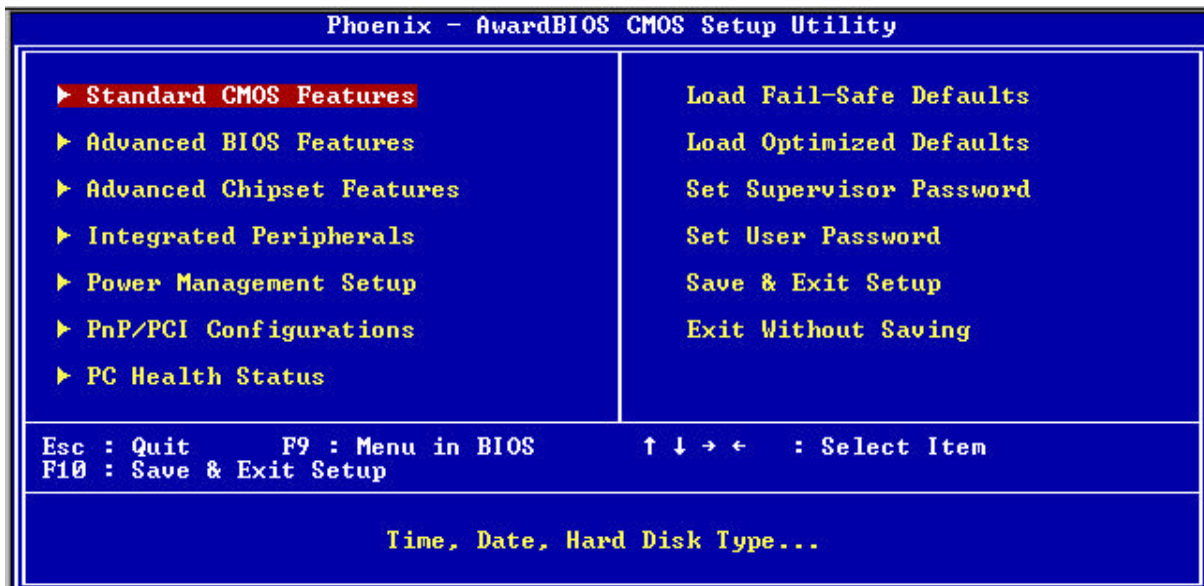

Figure 4-1: BIOS Setup Utility Main Menu

Standard CMOS Features

Use this menu for basic system configuration

Advanced BIOS Features

Use this menu to set the Advanced Features available on the system

Advanced Chipset Features

Use this menu to change the values in the chipset registers and optimize the system's performance

Integrated Peripherals

Use this menu to specify your settings for integrated peripherals

Power Management Setup

Use this menu to specify your settings for power management.

PnP/PCI Configurations

This entry appears if your system supports Plug and Play and PCI Configuration

PC Health Status

Displays CPU, System Temperature, Fan Speed, and System Voltages Value

Load Fail-Safe Defaults

Use this menu to load the BIOS default values for the minimal/stable performance for your system to operate

Load Optimized Defaults

Use this menu to load the BIOS default values, i.e., factory settings for optimal performance system operations. While Award has designed the custom BIOS to maximize performance, the factory has the option to change these defaults to meet their needs.

Set Supervisor/User Password

Enables you to change, set, or disable the supervisor or user password.

Save & Exit Setup

Saves CMOS value changes to CMOS and exits setup

Exit Without Saving

Ignores all CMOS value changes and exits setup.

4.5 Getting Help











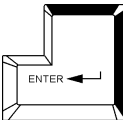
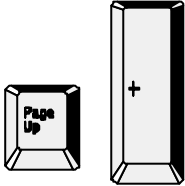
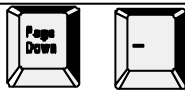

Main Menu

The on-line description of the highlighted setup function is displayed at the bottom of the screen.

Status Page Setup Menu/Option Page Setup Menu

4.6 Control Keys

The table below lists the keys that help you navigate the setup program.

Up arrow		Move to previous item
Down arrow		Move to next item
Left arrow		Move to the item to the left
Right arrow		Move to the item to the right
Esc key		<i>Main Menu:</i> Quit without saving changes to CMOS <i>Status/Option Page Setup Menus:</i> Exit current page and return to Main Menu.
Enter Key		Select or Accept an Item
PgUp/plus key		Increase the numeric value or make changes
PgDn/minus key		Decrease the numeric value or make changes
F1 key		General help, only for Status Page Setup Menu and Option Page Setup Menu
F2/Shift + F2 key		Change color from total 16 colors. F2 to select color forward, (Shift) F2 to select color backward
F5 key		Restore the previous CMOS value from CMOS (only for Option Page Setup Menu)
F6 key		Load the default CMOS value from BIOS default table (only for Option Page Setup Menu)
F7 key		Load the Setup default value (only for Option Page Setup Menu)
F9 Key		Menu in BIOS
F10 key		Save all the CMOS changes (only for Main Menu)

4.7 Standard CMOS Features

Selecting Standard CMOS Features on the main program screen displays the following menu:

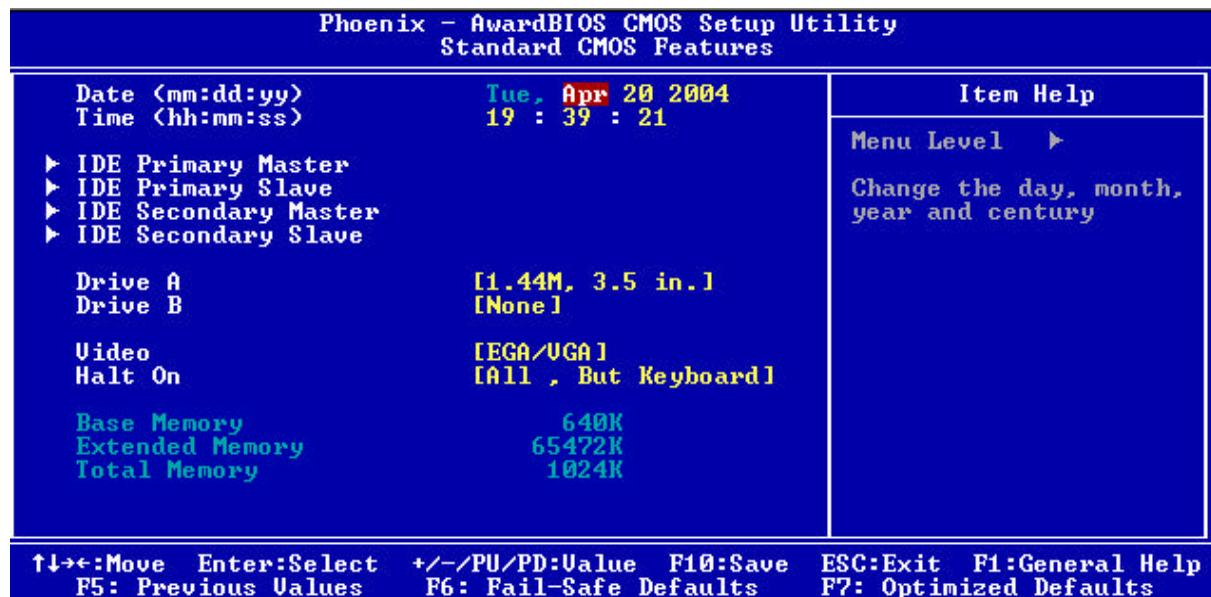

Figure 4-2: BIOS – Standard CMOS Features

The Standard CMOS Setup utility is used to configure the following features:

Date (mm:dd:yy)

The BIOS determines the day of the week from the other data information. This field is for information only. Press the left or right arrow key to move to the desired field (date, month, year). Press the PgUp or PgDn key to increment the setting, or type the desired value into the field.

Time (hh:mm:ss)

The time format is based on the 24-hour military time clock. For example, 1 p.m. is 13:00:00. Press the left

IDE Devices:

Your computer has two IDE channels (Primary and Secondary) and each channel can be installed with one or two devices (Master and Slave). Use these items to configure each device on the IDE channel. Press <Enter> to display the IDE submenu:

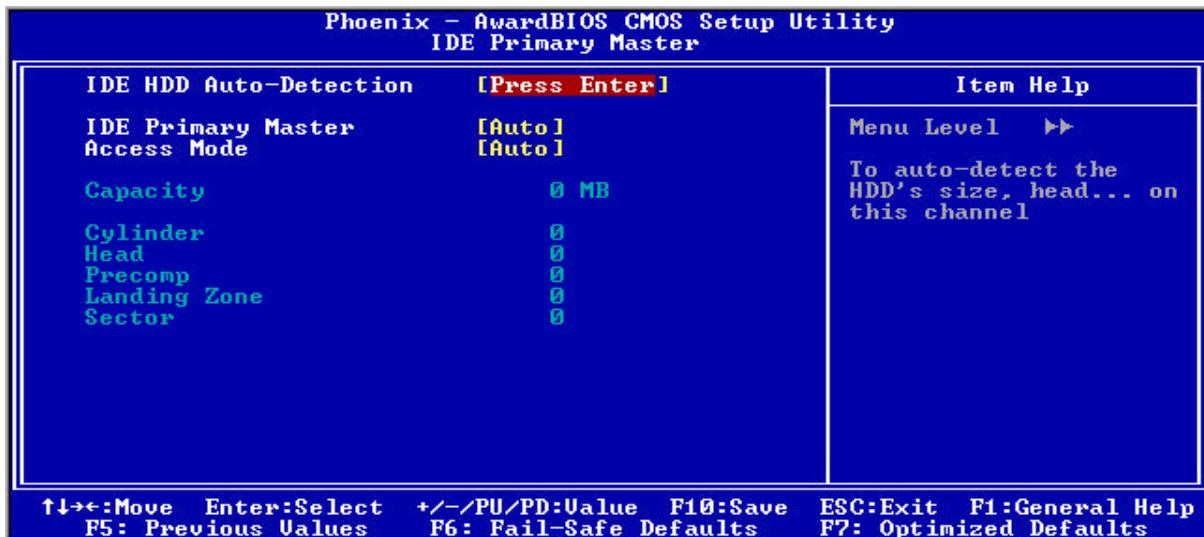

IDD HDD Auto Detection

Press <Enter> while this item is highlighted if you want the Setup Utility to automatically detect and configure a hard disk drive on the IDE channel.

If your system has an IDE hard drive, you can use this utility to detect its parameters and enter them into the Standard CMOS Setup automatically.

If the auto-detected parameters displayed do not match the one that should be used for your hard drive, do not accept them. Press <N> key to reject the values and enter the correct one manually in the Standard CMOS Setup screen.

Note: If you are setting up a new hard disk drive that supports LBA mode, more than one line will appear in the parameter box. Choose the line that lists LBA for an LBA drive.

Do not choose Large or Normal if the hard disk drive is already fully formatted when you installed it. Select the mode that was used to format it.

IDE Primary/Secondary Master/Slave

If you leave this item at Auto, the system will automatically detect and configure any IDE devices it finds. If it fails to find a hard disk, change the value to Manual and then manually configure the drive by entering the characteristics of the drive in the items below:

- ◆ Capacity Approximate hard disk drive capacity
- ◆ Cylinder Number of cylinders
- ◆ Head Number of heads
- ◆ Precomp Write pre-compensation cylinder
- ◆ Landing Zone Landing zone
- ◆ Sector Number of sector

Refer to your drive's documentation or look on the drive if you need to obtain this information. If no device is installed, change the value to None.

Access Mode

This item defines some special ways that can be used to access IDE hard disks such as LBA (Logical Block Addressing). Leave this value at Auto and the system will automatically decide the fastest way to access the hard disk drive.

Press <Esc> to close the IDE device submenu and return to the Standard CMOS Features page.

Drive A

Select this field to the type of floppy disk drive installed in your system. The choices are:

- ◆ None No floppy drive installed
- ◆ 360K, 5.25 in 5-1/4 inch PC type standard drive; 360 kilobyte capacity
- ◆ 1. 2M, 5.25 in 5-1/4 inch AT-type high-density drive; 1.2 megabyte capacity
- ◆ 720K, 3.5 in 3-1/2 inch double-sided drive; 720 kilobyte capacity
- ◆ 1.44M, 3.5 in 3-1/2 inch double-sided drive; 1.44 megabyte capacity
- ◆ 2. 88M, 3.5 in 3-1/2 inch double-sided drive; 2.88 megabyte capacity

Note: The None option could be used for diskless workstations.

Video

Set this field to the type of graphics card installed in your system. If you are using a BGA or higher resolution card, choose the EGA/VGA option. The options are:

- ◆ EGA/VGA Enhanced Graphics Adapter/Video Graphics Array. For EGA, VGA, SEGA or PGA monitor adapters
- ◆ CGA 40 Color Graphics Adapter, power up in 40 column mode
- ◆ CGA 80 Color Graphics Adapter, power up in 80 column mode
- ◆ MONO Monochrome adapter, includes high resolution monochrome adapters

Halt On

During the Power-On Self-Test (POST), the computer stops if the BIOS detect a hardware error. This setting determines which type of error will cause the system to halt during boot. The options are:

- ◆ All Error: Whenever the BIOS detects a non-fatal error, the system will be stopped and you will be prompted.
- ◆ No Errors: The system boot will not stop for any error that may be detected.
- ◆ All, But Keyboard: The system boot will not stop for a keyboard error, but it will stop for all others.
- ◆ All, But Diskette: The system boot will not stop for a disk error, but it will stop for all others.
- ◆ All, But Disk/Key: The system boot will not stop for a keyboard or disk error, but it will stop for all others.

Base/Extended/Total Memory

This category is display-only. The contents are determined by the POST (Power-On Self-Test) of the BIOS. You cannot make changes to these fields.

Base Memory: Also called conventional memory. The DOS operating system and conventional applications use this area.

Extended Memory: The POST of the BIOS will determine the amount of extended memory installed in the system.

Total Memory: This option shows system memory capacity.

After you have made your selections in the Standard CMOS Setup screen, press <ESC> to go back to the main screen.

4.8 Advanced BIOS Features

Selecting Advanced BIOS Feature on the main program screen displays this menu, which allows you to define advanced information about your system. You can make modifications to most of these items to improve your system performance or set up system features according to your preference, without causing fatal errors to your system.

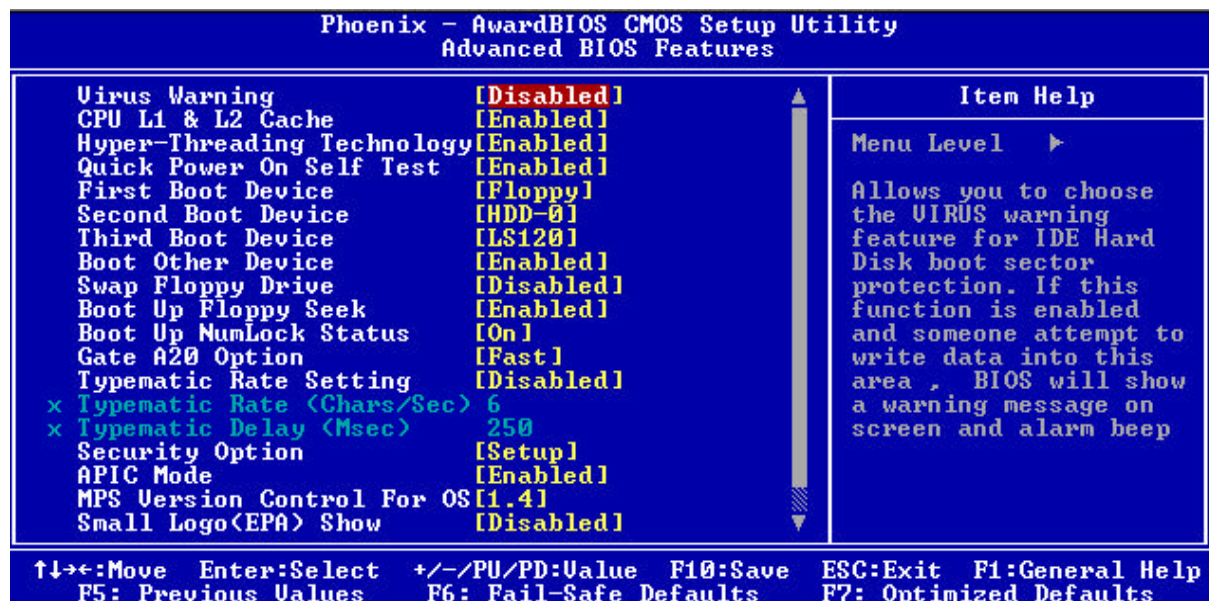

Figure 4-3: BIOS – Advanced BIOS Features

The following explains the options for each feature:

Virus Warning

Allow you to choose the Virus Warning feature for IDE Hard Disk boot sector protection. If this function is enabled and someone attempts to write data into this area, BIOS will show a warning message on screen and an alarm will beep.

- ◆ Enabled: Activates automatically when the system boots up causing the following warning message to appear when anything attempts to access the boot sector or hard disk partition table:

!WARNING!
Disk boot sector is to be modified
Type “Y” to accept write or “N” to abort write
Award Software, Inc.

- ◆ Disabled: No warning message will appear when an attempt is made to access the boot sector or hard disk partition table.

Note: This function is available only for DOS and other operating systems that do not trap INT13. For complete protection against viruses, install virus software in your operating system and update the virus definitions regularly.

Many disk diagnostic programs that access the boot sector table can trigger the virus warning message. If you plan to run such a program, we recommend that you disable the virus warning.

CPU L1 & L2 Cache

Cache memory is additional memory that is much faster than conventional DRAM (system memory). This BIOS feature is used to enable or disable the processor's Level 1 and Level 2 cache. Naturally, the default and recommended setting is Enabled.

Hyper Threading Technology

The Intel Hyper Threading Technology allows a single processor to execute two or more separate threads concurrently. When hyper threading is enabled, multi-threaded software applications can execute their threads in parallel, thereby improving the processor's performance.

Quick Power-On Self-Test

Select Enabled to reduce the amount of time required to run the Power-On Self-Test (POST). A quick POST skips certain steps. We recommend that you normally enable quick POST.

First/Second/Third Boot Device

BIOS attempts to load the operating system from the devices in the sequence selected. The available choices are: Floppy, LS120, Hard Disk, CDROM, ZIP100, USB-FDD, USB-ZIP, USB-CDROM, LAN, and Disabled.

Boot Other Device

If the selected boot devices fail to boot, selecting Enabled for this item allows the BIOS to boot from other boot devices (in a predefined sequence) which are present but not selected as boot devices are in the setup.

Swap Floppy Drive

If the system has two floppy drives, use this item to swap the logical drive name assignments.

Boot Up Floppy Seek

Enable this to allow the system to search for floppy drives during the POST. Disable this item to boot faster.

Boot Up NumLock Status

Toggle between On or Off to control the state of the NumLock key when the system boots. If On, the numeric keypad is in numeric mode. If Off, the numeric keypad is in cursor control mode.

Gate A20 Option

Enables you to select whether the chipset or the keyboard controller should control Gate A20.

The options are:

- * Normal: A pin in the keyboard controller controls Gate A20.
- * Fast: Lets chipset control Gate A20.

Typematic Rate Setting

If set to Enabled, enables you to set the Typematic Rate and Typematic Delay. When Disabled, the following two items (Typematic Rate and Typematic Delay) are irrelevant. Keystroke repeats at a rate determined by the keyboard controller in your system.

Typematic Rate (Chars/Sec): When the typematic rate setting is Enabled, you can select a typematic rate (the rate at which character repeats when you hold down a key) of 6, 8, 10, 12, 15, 20, 24, or 30 characters per second.

Typematic Delay (Msec): This setting controls the time between the display of the first character and successive characters. There are four delay choices: 250ms, 500ms, 750ms and 1000ms.

Security Option

Enables you to select whether the password is required every time the system boots or only when you enter Setup.

System: The system will not boot and access to Setup will be denied if the correct password is not entered at the prompt.

Setup: The system will boot, but access to Setup will be denied if the correct password is not entered at setup.

APIC Mode

The APIC Mode BIOS feature is used to enable or disable the motherboard's APIC (Advanced Programmable Interrupt Controller). If your single-processor motherboard supports APIC and you are using a Win32 operating system (Windows NT, 2000 and XP), it's recommended that you enable this feature to allow faster and better IRQ handling. If you are using a multiprocessor motherboard, you must enable this feature because it's required for IRQ handling in multiprocessor systems. Choose "Enable" when choosing Windows 2000 or Windows XP as your operating system.

MPS Version Control for OS

This feature is only applicable to multiprocessor motherboards as it specifies the version of the Multi-Processor Specification (MPS) that the motherboard will use. The MPS is a specification by which PC manufacturers design and build Intel architecture systems with two or more processors.

Small Logo (EPA) Show

If enabled, the small logo of the EPA will show.

Spread Spectrum

This item allows you to enable/disable the spread spectrum modulator to reduce EMI. The choices are Enabled and Disabled.

After you have made your selections in the Advanced BIOS Features setup, press <ESC> to go back to the main screen.

4.9 Advanced Chipset Features

Since the features in this section are related to the chipset in the CPU board and all are optimized, you are not recommended to change the default settings in the setup table, unless you understand the chipset features.

This section allows you to configure the system based on the specific features of the installed chipset. This chipset manage bus speeds and access to system memory resources, such as DRAM and the external cache. It also coordinates communications between the conventional ISA bus and the PCI bus. The default settings have been chosen because they provide the best operating conditions for your system. The only time you might consider making any changes would be if you discovered that data was being lost while using your system.

The first chipset settings deal with CPU access to dynamic random access memory (DRAM). The default timings have been carefully chosen and should only be altered if data is being lost. Such a scenario might well occur if your system has mixed speed DRAM chips installed so that greater delays may be required to preserve the integrity of the data held in the slower memory chips.

Selecting Advanced Chipset Features on the main program screen displays this menu:

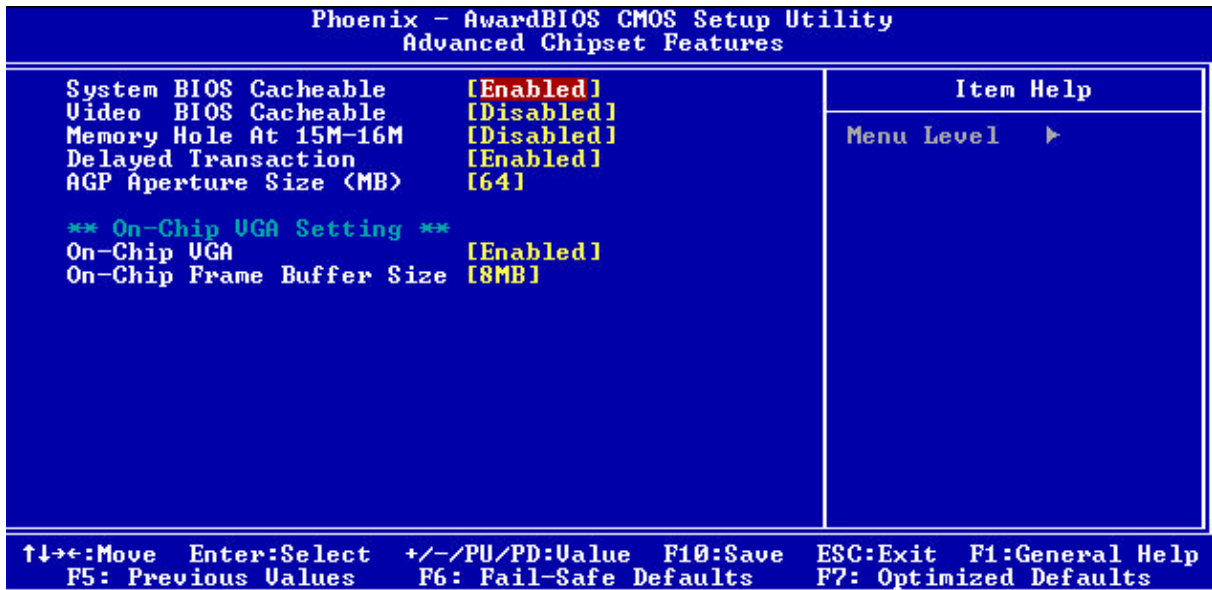

Figure 4-4: BIOS – Advanced Chipset Features

System BIOS cacheable

Selecting Enabled allows caching of the system BIOS ROM at F0000h-FFFFFh, resulting in better system performance. However, if any program writes to this memory area, a system error may result. The available choices are Enabled, Disabled.

Video BIOS Cacheable

Selecting Enabled allows caching of the video BIOS ROM at C0000h, resulting in better video performance. However, if any program writes to this memory area, a system error may result. The choices: Enabled, Disabled.

Memory Hole At 15M – 16M

In order to improve performance, certain space in memory is reserved for ISA cards; This memory must be mapped into the memory.

The choices: Enabled, Disabled.

Delayed Transaction

The chipset has an embedded 32-bit posted write buffer to support delayed transaction cycles. Select Enabled to support compliance with PCI specification version 2.1.

AGP Aperture Size (MB)

This item defines the size of the aperture if you use an AGP graphics adapter. The AGP aperture refers to a section of the PCI memory address range used for graphics memory. The available choices are: 4M, 8M, 16M, 32M, 64M, 128 M and 256M.

On-chip VGA

By default, the On-chip VGA or chipset-integrated VGA is enabled.

On-chip Frame Buffer Size

The On-chip Frame Buffer Size can be set as 1MB or 8MB. This memory is shared with the system memory.

4.10 Integrated Peripherals

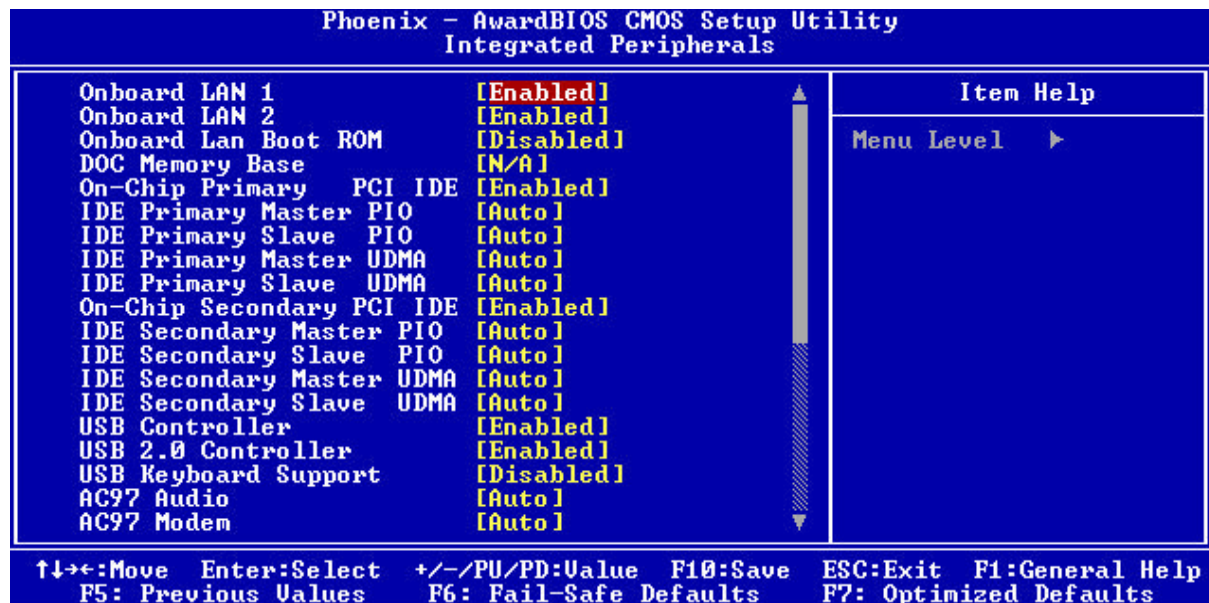

Figure 4-5: BIOS – Integrated Peripherals

Onboard LAN (1, 2)

Enable and disable the onboard LAN modules.

Onboard LAN boot ROM

Decide whether to invoke the boot ROM of the onboard LAN chip. The available choices are LAN1, LAN2, and Disabled.

DOC Memory Base

This function will be available when “Resources Controlled by” is set to Manual. The choice: N/A, C000, C800, D000, and D800.

On-Chip Primary/Secondary PCI IDE

The system chipset contains a PCI IDE interface with support for two IDE channels. Select Enabled to activate the primary and/or secondary IDE interface. Select Disabled to deactivate this interface, if you install a primary and/or secondary add-in IDE interface.

IDE Primary/Secondary Master/Slave PIO

The four IDE PIC (Programmable Input/Output) fields let you set a PIC mode (0-1) for each of the four IDE devices that the onboard IDE interface supports. Modes 0 through 4 provide successively increased performance. In Auto mode, the system automatically determines the best mode for each device. The choices are: Auto, Mode 0, Mode 1, Mode 2, Mode 3, and Mode 4.

IDE Primary/Secondary Master/Slave UDMA

Ultra DMA implementation is possible only if your IDE hard drive supports it and the operating environment includes a DMA driver (Windows 95 OSR2 or a third-party IDE bus master driver). If your hard drive and your system software both support Ultra DMA, select Auto to enable BIOS support. The choices are Auto, and Disabled.

USB Controller

Select Enabled if your system contains a Universal Serial Bus controller and you have USB peripherals.

USB 2.0 Controller

Select Enable if your system contain a Universal Serial Bus 2.0 controller and you have USB 2.0 peripherals.

USB Keyboard Support

Select Enabled if your USB controller is enabled and it needs USB keyboard support in legacy (old) OS operating systems such as DOS.

AC'97 Audio

Selecting Auto will enable the AC'97 audio if it is detected onboard.

AC'97 Modem

Selecting Auto will enable the AC'97 modem if it is detected onboard.

Init Display First

This item allows you to activate PCI slot or onboard display first. The choices are: PCI Slot, onboard VGA.

IDE HDD Block Mode

Block mode is also called block transfer, multiple commands, or multiple sector read/write. If your IDE hard drive supports block mode (most new drives do), select Enabled for automatic detection of the optional number of block read/write per sector the drive can support. The available choices are Enabled, Disabled.

Onboard FDC Controller

This feature allows you to enable or disable the onboard floppy drive controller. If you are using a floppy drive connected to the motherboard's built-in floppy drive controller, leave it at the default setting of Enabled. But if you are using an add-on floppy drive controller card or if you are not using any floppy drives at all, set it to Disabled to save an IRQ. Other devices can then use the free IRQ.

Onboard Parallel Port

This feature allows you to select the I/O address and IRQ for the onboard parallel port. The default I/O address of 378h and IRQ of 7 should work well in most cases. Unless you have a problem with the parallel port, you should leave it at the default settings. The choices: 378/IRQ7, 278/IRQ5, 3BC/IRQ7, and Disabled.

ECP Mode Use DMA

When the on-board parallel port is set to ECP mode, the parallel port can use DMA3 or DMA1.

Onboard Serial Ports (1, 2, 3, 4)

This feature allows you to manually select the I/O address and IRQ for the first and second serial ports. It is recommended that you leave it as Auto so that the BIOS can select the best settings for it. But if you need a particular I/O port or IRQ that's been taken up by this serial port, you can manually select an alternative I/O port or IRQ for it. You can also disable this serial port if you do not need to use it. Doing so frees up the I/O port and IRQ used by this serial port. Those resources can then be reallocated for other devices to use.

Serial Port (3,4) Use IRQ

The choices are : IRQ 3, 4, 5, 9, 10, 11.

Serial Port 1 Mode

Select an operating mode for the serial port 1. The choices are: Standard and IRDA.

Serial Port 2 Mode

Select an operating mode for the serial port 2. The choices are: Standard, RS422, RS485, RS422 (120 ohm) and RS485 (120 ohm).

AC'97 Modem

Selecting Auto will enable the AC'97 modem if it is detected onboard.

4.11 Power Management Setup

This option lets you control system power management. The system has various power-saving modes including powering down the hard disk, turning off the video, suspending to RAM, and software power down that allows the system to be automatically resumed by certain events.

The power-saving modes can be controlled by timeouts. If the system is inactive for a time, the timeouts begin counting. If the inactivity continues so that the timeout period elapses, the system enters a power-saving mode. If any item in the list of Reload Global Timer Events is enabled, then any activity on that item will reset the timeout counters to zero.

If the system is suspended or has been powered down by software, it can be resumed by a wake up call that is generated by incoming traffic to a modem, a LAN card, a PCI card, or a fixed alarm on the system real-time clock.

Selecting Power Management Setup on the main program screen displays this menu:

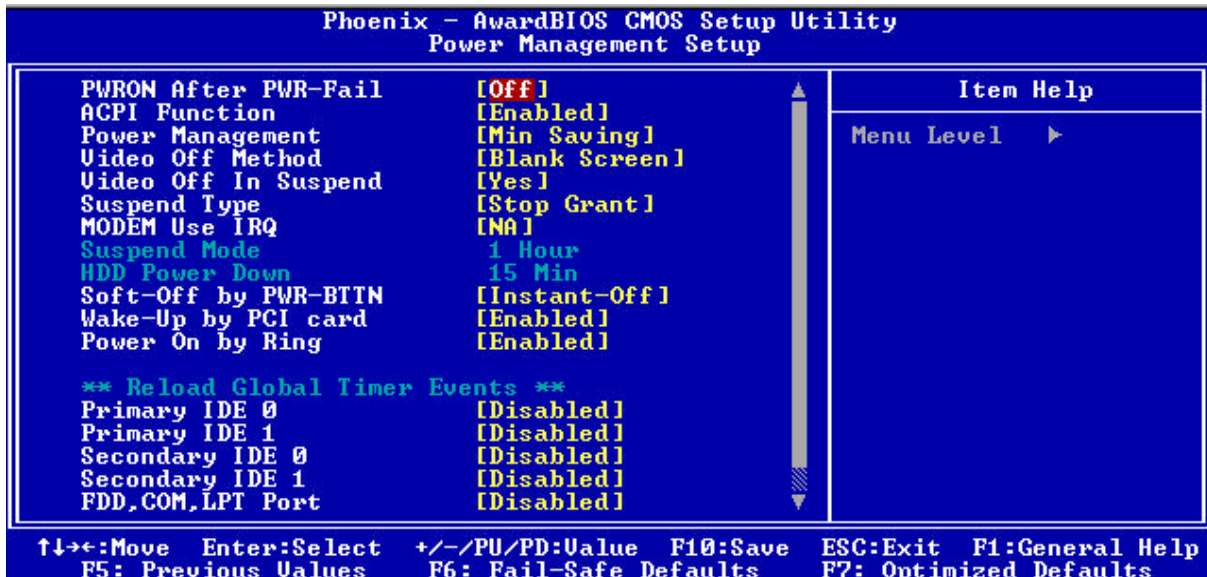

Figure 4-8: BIOS – Power Management Setup

PWRON After PWR-Fail

This setting specifies whether your system reboots after a power failure. There are three selections:

Off: The system will remain off when power comes back after a power failure.

On: The system will switch on when power comes back after a power failure.

ACPI Function

The ACPI standard (Advanced Configuration and Interface power) allows the operating system directly to check the functions of energy saving and the PnP (Plug and Play) functionality. The ACPI functions are normally activated by the BIOS. The choices are: Enabled and Disabled.

Power Management

This category allows you to select the type (or degree) of power saving and is directly related to the following modes: HDD Power Down, Doze Mode and Suspend Mode

- ◆ Min. Saving: Minimum power management
- ◆ Max Saving: Maximum power management
- ◆ User Define: Allows you to set each mode individually

Video Off Method

This determines the manner in which the monitor is blanked. There are three choices:

1. V/H SYNC+Blank: This selection will cause the system to turn off the vertical and horizontal synchronization port and write blanks to the video buffer.
2. Blank Screen: This option only writes blanks to the video buffer.
3. DPMS Support: Select this option if your monitor supports the Display Power Management signaling (DPMS) standard of the Video Electronics Standard to select video power management values.

Video Off in Suspend

This determines the manner in which the monitor is blanked. The choices: Yes, No.

Suspend Type

Select the Suspend Type. the choices: PwrOn Suspend and Stop Grant.

MODEM Use IRQ

This determines the IRQ in which the MODEM can use. The choices are 3, 4, 5, 7, 9, 10, 11, and NA.

Soft-Off by PWR-BTTN

This function can turn the system off with the on/off button places the system in a very low-power-usage state, with only enough circuitry receiving power to detect power button activity or Resume by Ring activity. The choices are Delay 4 seconds, and Instant-Off.

Wake Up by PCI Card

When the system enters a Soft-off mode (Standby power exist but system is not working), it will wake up system when specific signals occurred. The BIOS monitors the system for “activity” to determine when to enable power management.

If you enable this feature, the computer specifies that any signal noticed on the PCI (Peripheral Component Interconnect) bus channel must make go out from the hibernation state. The choices: Enabled, Disabled

Power On by Ring

An input signal on the serial Ring Indicator (RI) line (in other words, an incoming call on the modem) awakens the system from a soft off state. The choices: Enabled, Disabled.

Wake Up on Giga LAN

When the system enters a Soft-off mode (Standby power exists but system is not working), it will wake up system when specific signals occur. the BIOS monitors the system for “activity” to determine when to enable power management.

If you enable this feature, the computer specifies that any signal noticed on the LAN must make go out from the hibernation state. The choices: Enabled, Disabled.

Reload Global Timer Events

Primary/Secondary IDE 0/1

FDD, COM, LPT Port

PCI PIRQ [A-D]#

The events are I/O events whose occurrence can prevent the system from entering a power saving mode or can awaken the system from such a mode. In effect, the system remains alert for anything, which occurs to a device, which is configured as Enabled, even when the system is in a power down mode. The choices are Enabled, and Disabled.

After you have made your selections in the Power Management setup, press the <ESC> key to go back to the main program screen.

4.12 PnP/PCI Configurations

This section describes configuring the PCI bus system. Peripheral Component Interface, is a system which allows I/O devices to operate at speeds nearing the speed the CPU itself uses when communicating with its own special components. This section covers some very technical items and it is strongly recommended that only experienced users should make any changes to the default settings.

Selecting PnP/PCI Configurations on the main program screen displays this menu:

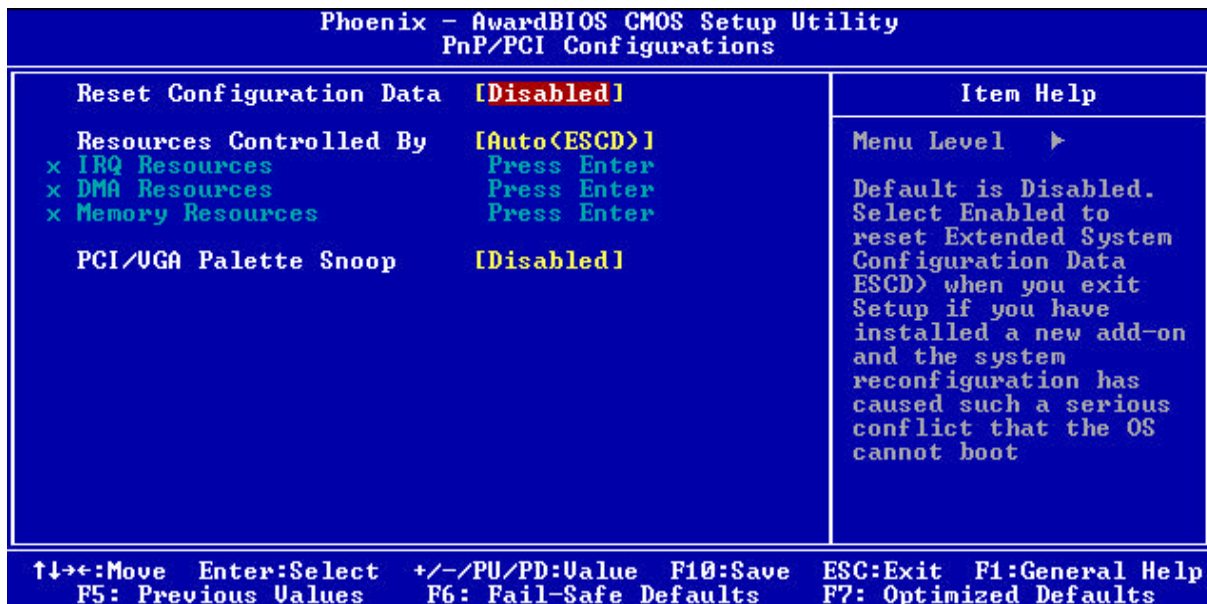

Figure 4-9: BIOS – PnP/PCI Configurations

Reset Configuration Data

Normally, you leave this field Disabled, Select Enabled to reset Extended System Configuration Data (ESCD) when you exit Setup if you have installed a new add-on Card and the system reconfiguration has caused such a serious conflict that the operating system can not boot. The choices are Enabled and Disabled.

Resources Controlled By

The Award Plug and Play BIOS has the capacity to automatically configure all of the boot and Plug and Play compatible devices. However, this capability means absolutely nothing unless you are using a Plug and Play operating system such as going into each of the submenus that follows this field. The choices are Auto (ESCD), Manual.

This setting is used only to solve the visualization problems with dedicated MPEG decompression cards. In such specific case, setup the voice on Enabled to allow the BIOS to monitor the visualization passages between the principal card and the card of decodes. The default setting is Disabled.

4.13 PC Health Status

When main boards support hardware monitoring, this item lets you monitor the parameters for critical voltages, critical temperatures, and fan speeds. These are the read only items.

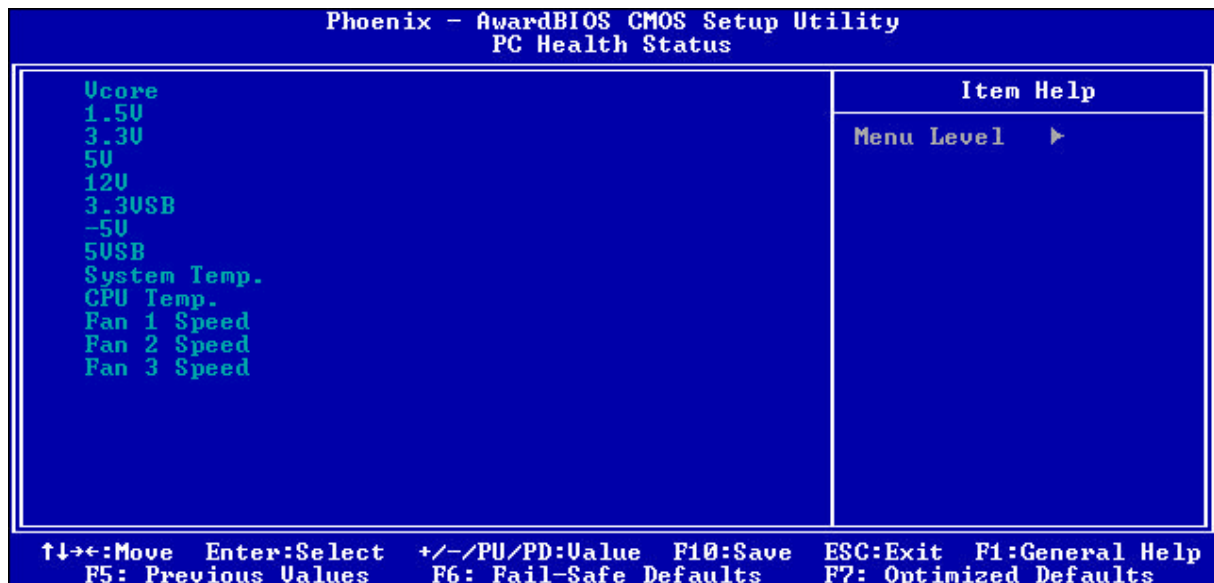

Figure 4-10: BIOS – PC Health Status

After you have read the PC Health Status, press the <ESC> key to go back to the main program screen.

4.14 Load Fail-Safe Defaults

This option opens a dialog box that lets you install fail-safe defaults for all appropriate items in the whole setup utility. Press the <Y> key and then <Enter> to install the defaults. Press the <N> key and then <Enter> to not install the defaults.

Use this option if you have changed your system and it does not operate correctly or does not power up.

4.15 Load Optimized Defaults

This option opens a dialog box that lets you install optimized defaults for all appropriate items in the whole setup utility. Press the <Y> key and then <Enter> to install the defaults. Press the <N> key and then <Enter> to not install the defaults. The optimized defaults place demands on the system that may be greater than the performance level of the components, such as the CPU and the memory. You can cause fatal errors or instability if you install the optimized defaults when your hardware does not support them. If you only want to install setup defaults for a specific option, select and display that option, and then press the <F7> key.

4.16 Set Supervisor/User Password

The Supervisor/User Password utility sets the password. The main board is shipped with the password disabled. If you want to change the password, you must first enter the current password, then at the prompt enter your new password. The password is case sensitive. You can use up to eight alphanumeric characters. Press <Enter> after entering the password. At the next prompt, confirm the new password by retyping it and pressing <Enter> again.

To disable the password dialog box appears. A message appears confirming that the password has been disabled. If you have set supervisor and user Password, only the supervisor password allows you to enter the BIOS setup program.

Note: If you forget your password, the only way to solve this problem is to discharge the CMOS memory by turning power off and placing a shunt (jumper cap) on jumper JP11 to short pin 2 and pin 3 for five seconds, then putting the shunt back to pin 1 and pin 2 of JP11.

4.17 Save & Exit Setup

Selecting this option and pressing <Enter> will save the new setting information in the CMOS memory and continue with the booting process.

4.18 Exit Without Saving

Selecting this option and pressing <Enter> will exit the Setup utility without recording any new values or changing old ones.

This concludes Chapter 4. The next chapter covers drivers installing.

Chapter 5 Driver Installation

The NEX716VL2G series comes with a CD that enables you to install Intel Chipset, LAN and Audio Drivers. These drivers may be updated or re-versioned without any further notice. Please visit NEXCOM web site <http://www.nexcom.com.tw> frequently for new information.

Note: The installation instructions in this manual are based on Windows 2000 operation system.

5.1 Installing CD

Please follow the instructions below to find Audio, IAA, INF, LAN, USB and VGA Drivers on the given CD to implement installation.

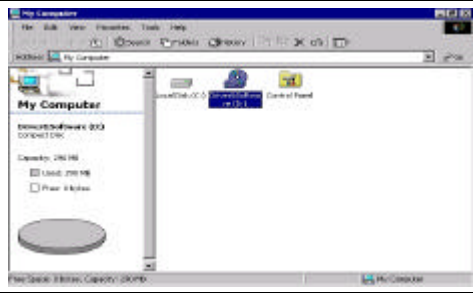
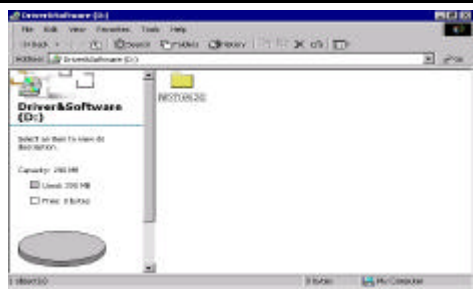
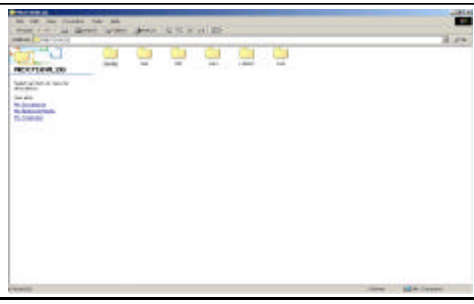
<p>Step 5.1.1</p> <p>Place the Driver CD into your CD-ROM drive. Open My computer on your desktop and double click Drive D.</p>	
<p>Step 5.1.2</p> <p>Double click the NEX716VL2G to open.</p>	
<p>Step 5.1.3</p> <p>Software utilities found include Audio, IAA, INF, LAN, USB and VGA.</p>	

5.2 Installing Drivers for the NEX716L2VG Series

The following sections cover the installation of each driver for the NEX716L2VG Series:

- ◆ **Audio** --- **5.3**
- ◆ **IAA** --- **5.4**
- ◆ **INF** --- **5.5**
- ◆ **LAN** --- **5.6**
- ◆ **USB** --- **5.7**
- ◆ **VGA** --- **5.8**

Note: You should install the Intel chipset patch before installing other drivers. You may be prompted for your Windows Installation CD during setup.

5.3 Installing Audio Driver

Install this audio driver only when you connect an audio card into the Nex716VL2G.

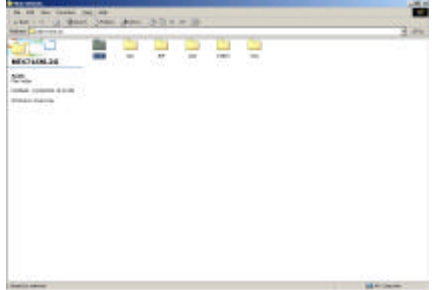
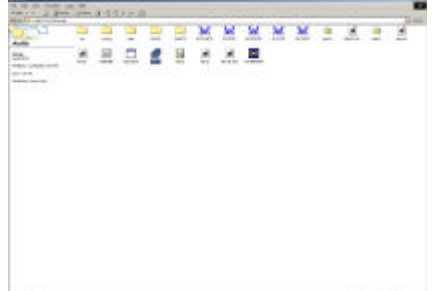
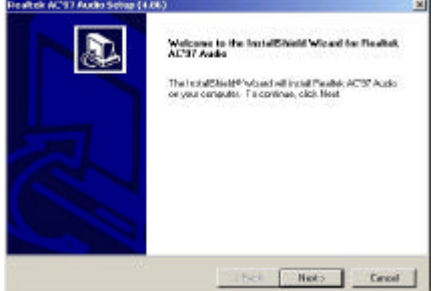
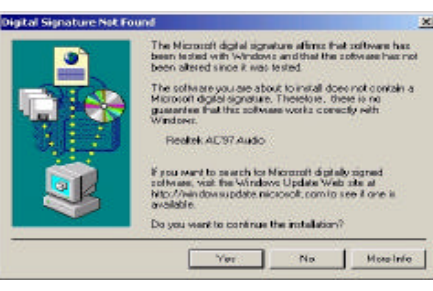
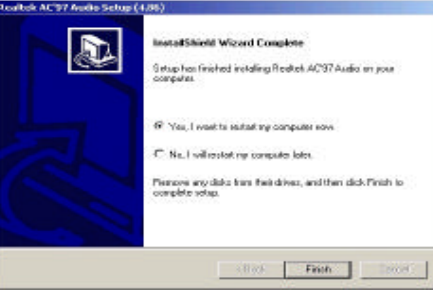
<p>Step 5.3.1</p> <p>Double click the Audio Folder to open.</p>	
<p>Step 5.3.2</p> <p>Double click the Setup Icon to start the installation process.</p>	
<p>Step 5.3.3</p> <p>When the Welcome screen appears, click Next to continue.</p>	
<p>Step 5.3.4</p> <p>Click Yes to continue the installation process. The setup program copies files into your computer.</p>	
<p>Step 5.3.5</p> <p>The program updates your computer driver files, and you are prompted to restart your computer. Click Yes, I want to restart my computer now and then click Finish to reboot.</p>	

5.4 Installing Intel Application Accelerator

<p>5.4.1</p> <p>Double click to open the IAA folder.</p>	
<p>5.4.2</p> <p>Double click the folder to open.</p>	
<p>5.4.3</p> <p>Click Next to continue the installation process.</p>	
<p>5.4.4</p> <p>To install to this folder, click Next. To install to a different folder, click Browse and select another folder.</p>	
<p>5.4.5</p> <p>Click Next to continue.</p>	
<p>5.4.6</p> <p>The program updates your computer driver files, and you are prompted to restart your computer. Click Yes, I want to restart my computer now and then click Finish to reboot.</p>	

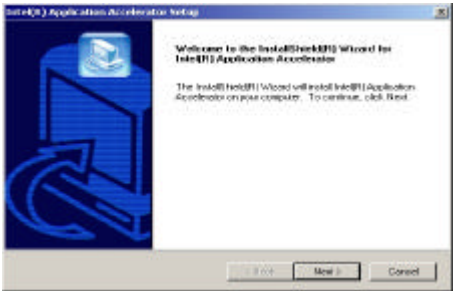
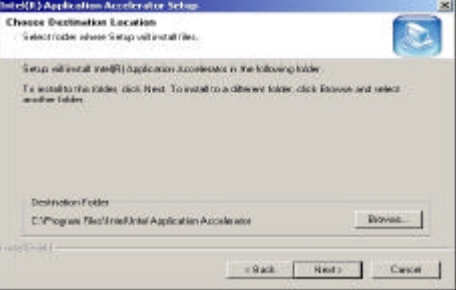
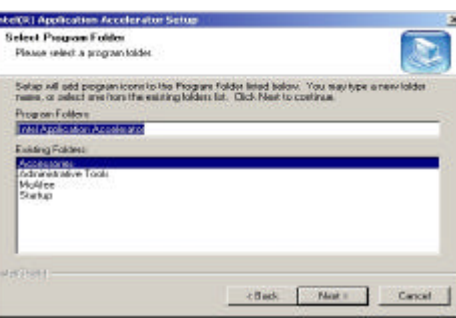
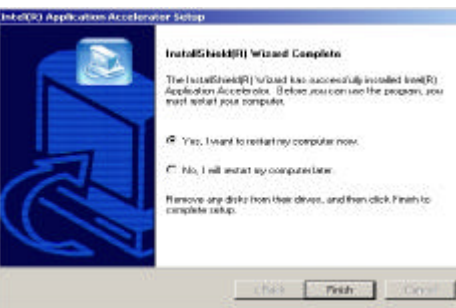
<p>5.4.3</p> <p>Click Next to continue the installation process.</p>	
<p>5.4.4</p> <p>To install to this folder, click Next. To install to a different folder, click Browse and select another folder.</p>	
<p>5.4.5</p> <p>Click Next to continue.</p>	
<p>5.4.6</p> <p>The program updates your computer driver files, and you are prompted to restart your computer. Click Yes, I want to restart my computer now and then click Finish to reboot.</p>	

5.5 Installing the Intel Chipset

After installing the IAA driver, repeat steps 5.1.1 and 5.1.2 to open the Intel Chipset folder.

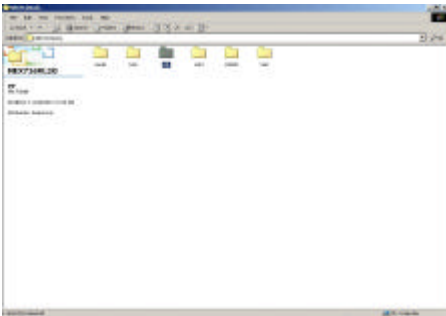
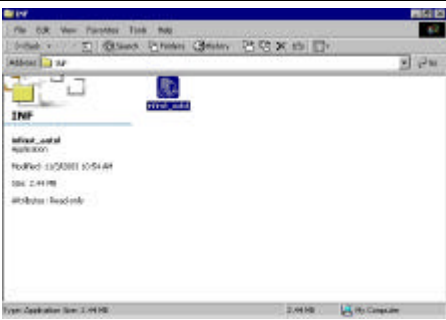
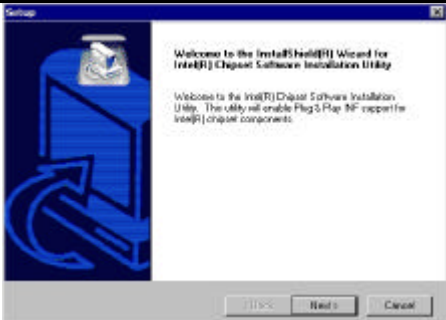
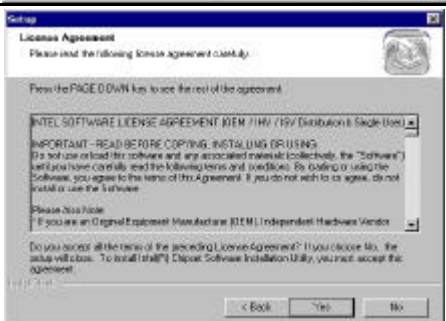
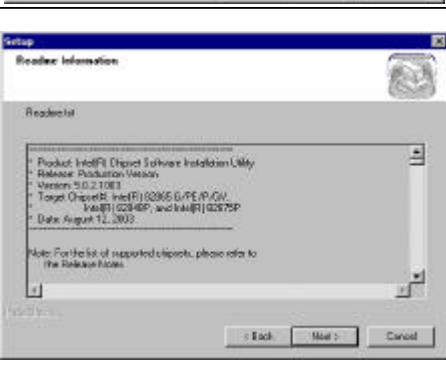
<p>5.5.1</p> <p>Double click to open the INF folder.</p>	
<p>5.5.2</p> <p>Click on the folder to open.</p>	
<p>5.5.3</p> <p>Click Next to start the installation process.</p>	
<p>5.5.4</p> <p>Read the License Agreement. If you accept it, click Yes to continue.</p>	
<p>5.5.5</p> <p>Read the ReadMe information and click Next to continue.</p>	

5.5.6

The program updates your computer driver files, and you are prompted to restart your computer. Click Yes, I want to restart my computer now and then click Finish to reboot.

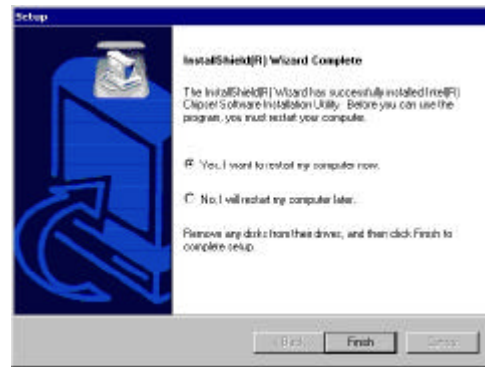

5.6 Installing the LAN Driver

After installing the the Intel Chipset driver, repeat steps 5.1.1 and 5.1.2 to open the LAN 82541and 82562 folders whose procedures are the same. (Notes: Intel 82541GI LAN driver can not support NT4.0)

5.6.1

Click on the Add/Remove Hardware icon to open.

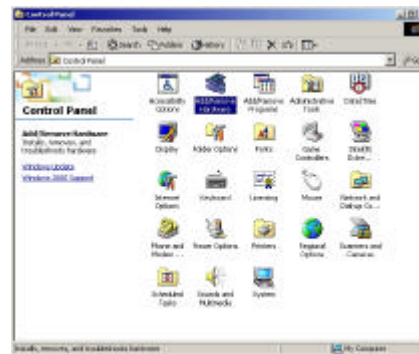

5.6.2

To continue, click Next.





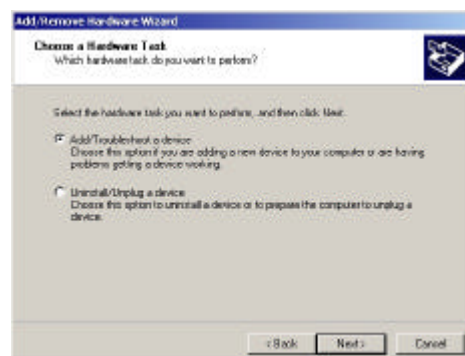

5.6.3

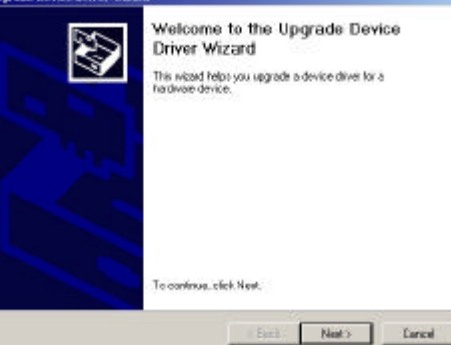
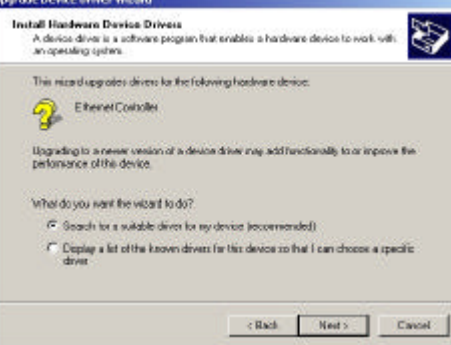
Select the hardware task you want to perform, and then click Next.

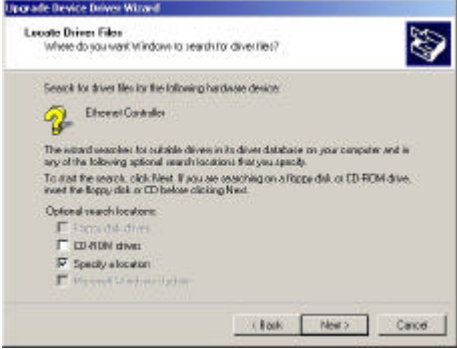

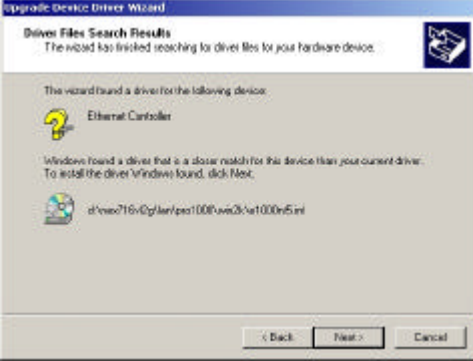



<p>5.6.4</p> <p>Select Add a new device and then click Next.</p>	
<p>5.6.5</p> <p>Click Finish after choosing the new device.</p>	
<p>5.6.6</p> <p>Click Next to continue.</p>	
<p>5.6.7</p> <p>Tick Search for a suitable driver for my device and click Next.</p>	



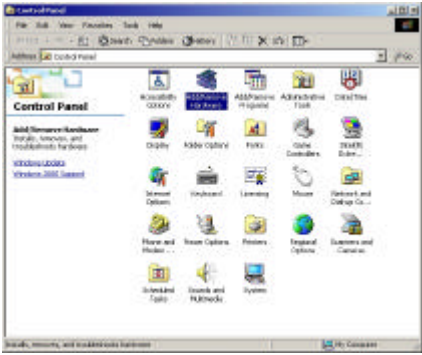

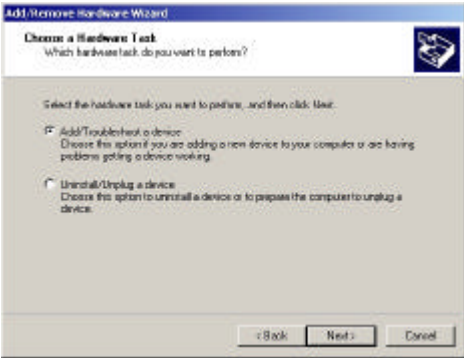
<p>5.6.8</p> <p>To start the search, click Next.</p>	
<p>5.6.9</p> <p>Insert the manufacturer's installation disk into the drive selected, and then click OK.</p>	
<p>5.6.10</p> <p>To install the driver Windows found, click Next.</p>	
<p>5.6.11</p> <p>To close this wizard, click Finish.</p>	

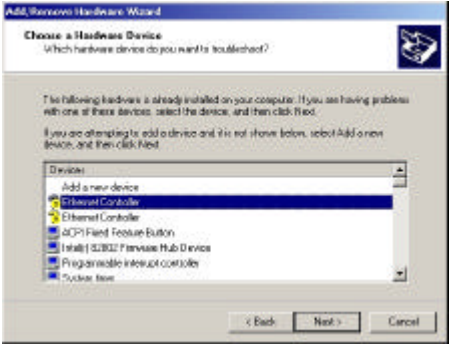
5.7 Installing the USB Driver

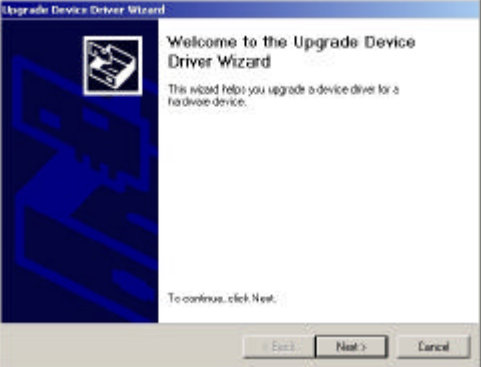
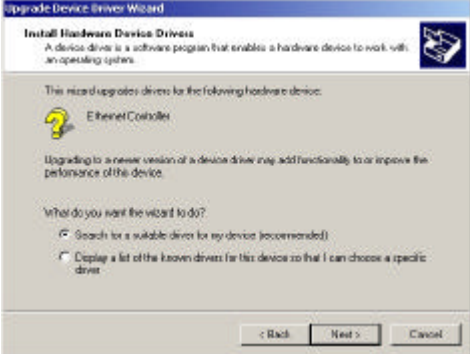
After installing the LAN driver, repeat steps 5.1.1 and 5.1.2 to open the USB folder.

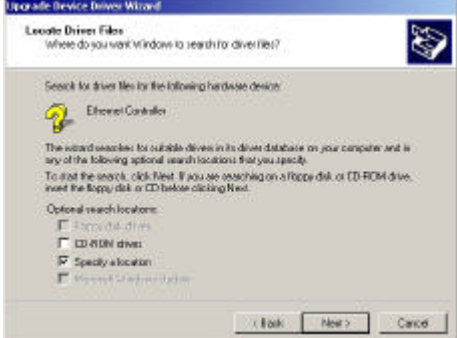
<p>5.7.1</p> <p>Click on the Add/Remove Hardware icon to open.</p>	
<p>5.7.2</p> <p>To continue, click Next.</p>	
<p>5.7.3</p> <p>Select the hardware task you want to perform, and then click Next.</p>	

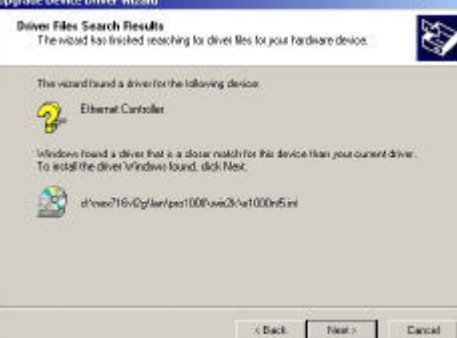
<p>5.7.4</p> <p>Select Add a new device and then click Next.</p>	
<p>5.7.5</p> <p>Click Finish after choosing the new device.</p>	
<p>5.7.6</p> <p>Click Next to continue.</p>	
<p>5.7.7</p> <p>Tick Search for a suitable drive for my device and click Next.</p>	

<p>5.7.8</p> <p>To start the search, click Next.</p>	
<p>5.7.9</p> <p>Insert the manufacturer's installation disk into the drive selected, and then click OK.</p>	
<p>5.7.10</p> <p>To install the driver Windows found, click Next.</p>	
<p>5.7.11</p> <p>To close this wizard, click Finish.</p>	

5.8 Installing the VGA Driver

After installing the USB driver, repeat steps 5.1.1 and 5.1.2 to open the VGA folder.

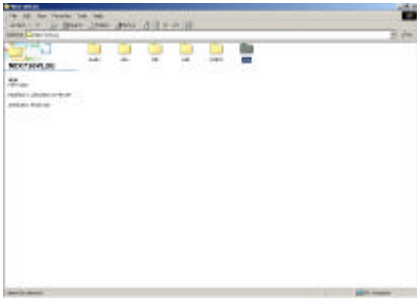
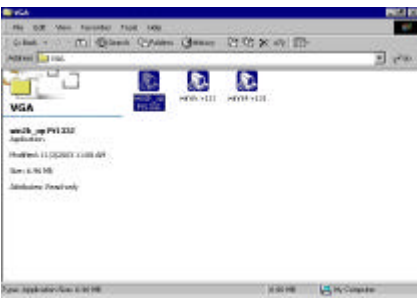
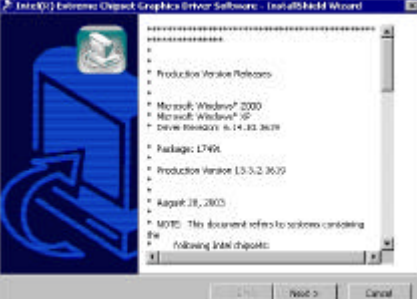
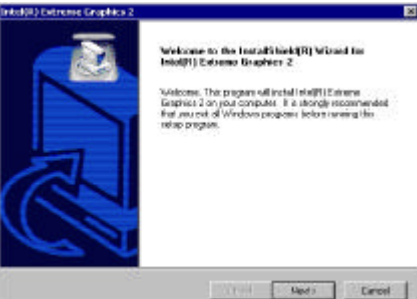
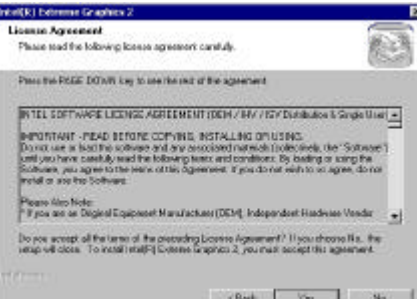
<p>5.8.1</p> <p>Double click the VGA folder to open.</p>	
<p>5.8.2</p> <p>Click on the Highlighted icon to open.</p>	
<p>5.8.3</p> <p>Click Next to start the installation process.</p>	
<p>5.8.4</p> <p>Click Next when the welcome page appears.</p>	
<p>5.8.5</p> <p>Read the License Agreement. If you agree it, click Yes to continue.</p>	

5.8.6

The complete installation screen appears. Select Yes, I want to restart my computer now, and click Finish to reboot your computer.

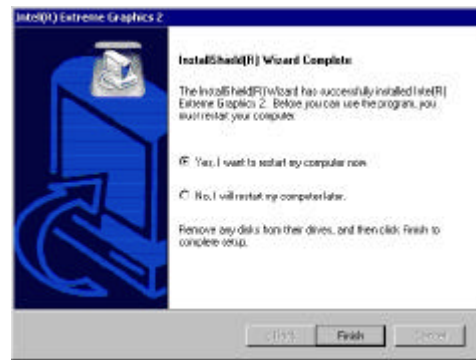

Appendix A

Watchdog Timer

The NEX716VL 2G series features a watchdog timer that reset the CPU or generates an interrupt if the processor stops operating for any reason. This feature ensures system reliability in industrial standalone or unmanned environments.

Panel Button De-bounce Base Address LSB Register (Index=65h, Default=00h)

Bit	Description
7-0	Read/write, mapped as Base Address[7:0]

Panel Button De-bounce Interrupt Level Select Register (Index=70h, Default=00h)

Bit	Description
7-4	Reserved
3-0	Select the interrupt level (note1) for Panel Button De-bounce

Watch Dog Timer Control Register (Index=71h, Default=00h)

Bit	Description
7	WDT is reset upon a CIR interrupt.
6	WDT is reset upon a KBC (mouse) interrupt.
5	WDT is reset upon a KBC (keyboard) interrupt.
4	WDT is reset upon a read or a write to the Game Port base address.
3-2	Reserved
1	Force Time-out. This bit is self-clearing.
	WDT Status
0	1:WDT value reaches 0.
	0:WDT value is not 0.

Watch Dog Timer Configuration Register (Index=72h, Default=00h)

Bit	Description
	WDT Time-out value select
7	1:Second
	0:Minute
6	WDT output through KRST (pulse) enable
5-4	Reserved
3-0	Select the interrupt level (note1) for WDT.

Watch Dog Timer Time-Out Value Register (Index=73h, Default=00h)

Bit	Description
7-0	WDT time-out value 7-0

Sample Code:

```
;Enter config mode  
out 2E, 87h  
out 2E, 01h  
out 2E, 55h  
out 2E, 55h
```

```
;Set LDN=7  
out 2E, 07h  
out 2E, 07h
```

```
;Set WDT enable, second mode  
out 2E, 72h  
out 2E, 0C0h
```

```
;Set value=3  
out 2E, 73h  
out 2E, 03h
```

Appendix B

GPI/O Programming

GPI base address : 4B8

GPI4	GPI3	GPI2	GPI1				
------	------	------	------	--	--	--	--

GPO base address : 4B9

				GPO4	GPO3	GPO2	GPO1
--	--	--	--	------	------	------	------

GPI1	1	2	GPO1
GPI2	3	4	GPO2
GPI3	5	6	GPO3
GPI4	7	8	GPO4