

VXC-1x8U/PCIe-S1x8 Series User Manual

Serial Communication Board with 8 RS-232/422/485 Ports

Version 1.1.3, Jan. 2015

WARRANTY

All products manufactured by ICP DAS are warranted against defective materials for a period of one year from the date of delivery to the original purchaser.

WARNING

ICP DAS assumes no liability for damages consequent to the use of this product. ICP DAS reserves the right to change this manual at any time without notice. The information furnished by ICP DAS is believed to be accurate and reliable. However, no responsibility is assumed by ICP DAS for its use, nor for any infringements of patents or other rights of third parties resulting from its use.

COPYRIGHT

Copyright © 2015 by ICP DAS. All rights are reserved.

TRADEMARKS

Names are used for identification purposes only and may be registered trademarks of their respective companies.

CONTACT US

If you have any questions, please feel free to contact us at:

Email: service@icpdas.com, service.icpdas@gmail.com

We guarantee to give you response within 2 working days.

SUPPORT

This manual relates to the following cards:
VXC-118U, VXC-148U
PCIe-S118, PCIe-S148

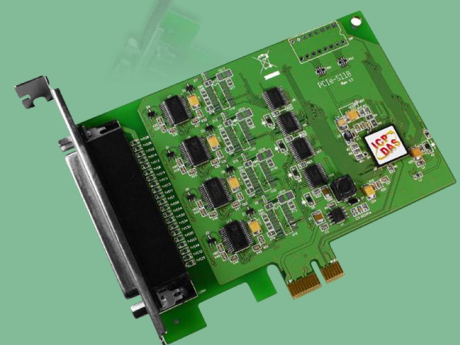
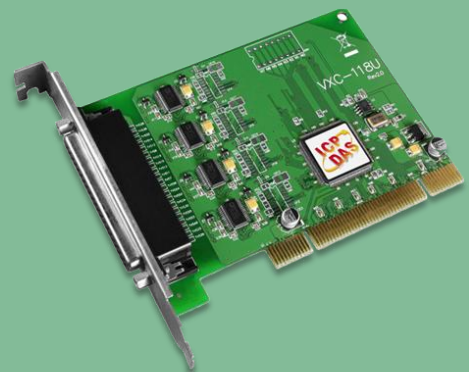

ICP DAS CO., LTD.

service@icpdas.com

<http://www.icpdas.com>







Table of Contents

PACKING LIST.....	3
MORE INFORMATION	3
1. INTRODUCTION.....	4
1.1 FEATURES	5
1.2 SPECIFICATIONS.....	7
1.2.1 VXC-118U/PCle-S1x8.....	7
1.2.2 VXC-148U/PCle-S148	8
1.3 OPTIONS	9
2. HARDWARE CONFIGURATION.....	10
2.1 BOARD LAYOUT.....	10
2.1.1 VXC-118U/VXC-148U	10
2.1.2 PCle-S118/PCle-S148.....	11
2.2 WIRING NOTES FOR RS-232/422/485	12
2.2.1 RS-232 Wiring	12
2.2.2 RS-485 Wiring	12
2.2.3 RS-422 Wiring	13
2.3 PIN ASSIGNMENTS	14
2.3.1 VXC-118U/PCle-S118	14
2.3.2 VXC-148U/PCle-S148	15
3. HARDWARE INSTALLATION	16
4. SOFTWARE INSTALLATION	20
4.1 OBTAINING THE DRIVER INSTALLER PACKAGE.....	20
4.2 INSTALLING VXC-1x8U SERIES DRIVER.....	21
4.3 INSTALLING PCIE-S1x8 SERIES DRIVER	24
4.4 PNP DRIVER INSTALLATION	26
4.5 VERIFYING THE INSTALLATION	28
4.5.1 Accessing Windows Device Manager.....	28
4.5.2 Check the Configuration of the COM Port.....	30
4.6 MANUAL COM PORT CONFIGURATION	31
4.6.1 VXC-118U/VXC-148U	31
4.6.2 PCle-S118/PCle-S148.....	33
4.7 UNINSTALLING THE DEVICE DRIVER.....	36
5. TESTING THE MULTIPOINT SERIES CARD	37
5.1 SELF-TEST WIRING	37
5.2 EXECUTE THE TEST PROGRAM.....	39

Packing List

The shipping package includes the following items:

	One VXC-1x8U or PCIe-S1x8 Series Card	 Note: If any of these items are missing or damaged, please contact the local distributor for more information. Save the shipping materials and cartons in case you need to ship the card in the future.
	One Quick Start Guide	
	One Software Utility CD	
	One CA-PC62M Connector	

More Information

Manual/DataSheet/QuickStart:

CD:\NAPDOS\multiport\document

<http://ftp.icpdas.com/pub/cd/iocard/pci/napdos/multiport/document/>

Software/Drivers:

CD:\NAPDOS\multiport\windows

<http://ftp.icpdas.com/pub/cd/iocard/pci/napdos/multiport/windows/>

Software/Test2COM/Utility:

CD:\NAPDOS\multiport\utility

<http://ftp.icpdas.com/pub/cd/iocard/pci/napdos/multiport/utility/>

1. Introduction

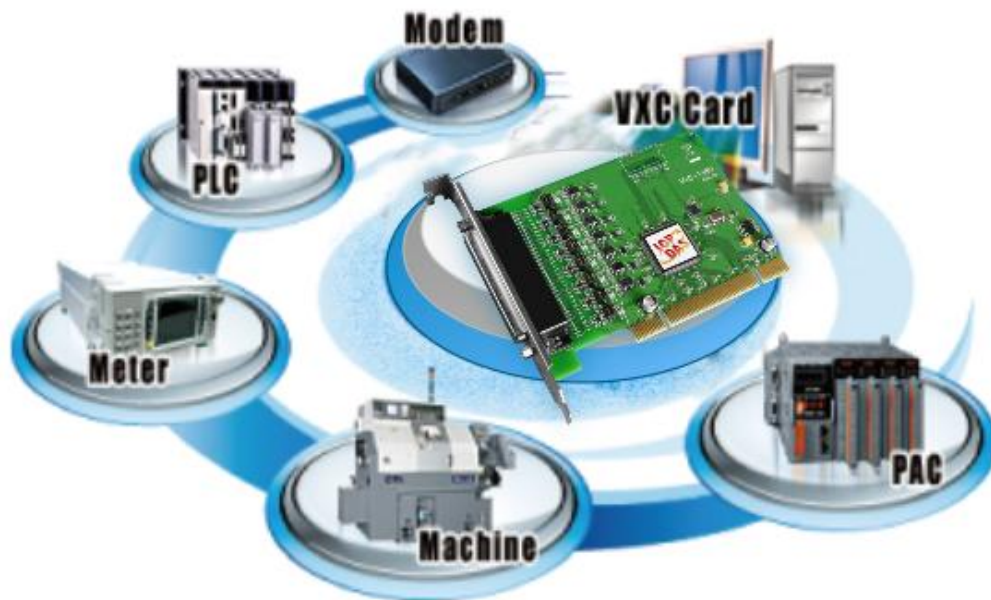

The VXC-1x8U and PCIe-S1x8 multiport series card is the foremost choice for PC-based communication solutions, ensuring smooth communication in both time-critical applications and industrial fields. Installing a multiport card increases the number of serial ports available on the PC, meaning that it is much easier to integrate a PC with a large number of external devices, such as PLCs, meters, controllers, laboratory instruments, modems, card readers, serial printers, RFID readers, bar code readers, and sensors, etc.

Comparison Table for VXC-1x8U and PCIe-S1x8 Series Cards:

Model	Bus	RS-232	RS-422/RS-485	Self-Tuner	FIFO Size (bytes)	Connector
VXC-118U	Universal PCI	8	-	-	256	Female DB-62
VXC-148U	Universal PCI	-	8	Yes	256	Female DB-62
PCIe-S118	PCI Express	8	-	-	256	Female DB-62
PCIe-S148	PCI Express	-	8	Yes	256	Female DB-62

1.1 Features

Universal PCI (3.3 V/5 V) for VXC-1x8U Series Card

The Universal PCI card works with both newer 3.3 V PCI bus that is widely-used in servers, and the traditional 5 V PCI bus. The Universal PCI interface will be the standard for every card developed by ICP DAS in the near future.

PCI Express for PCIe-S1x8 Series Card

PCI Express (PCIe) is a computer expansion card standard. A key difference between PCIe and earlier PC buses is a topology based on point-to-point serial links, rather than shared parallel bus architecture. Conceptually, the PCIe bus can be thought of as a 'high-speed serial replacement' of the older PCI/PCI-X bus.

Hardware FIFO up to 256 bytes

FIFO is an acronym for "First In, First Out", and is a method used for organizing and manipulating data relative to time and prioritization. FIFO is used for buffering and flow control while the data is transmitted from the hardware to the software. When using a hardware FIFO (buffer), a small delay in either the software or the operating system will not cause any data loss.

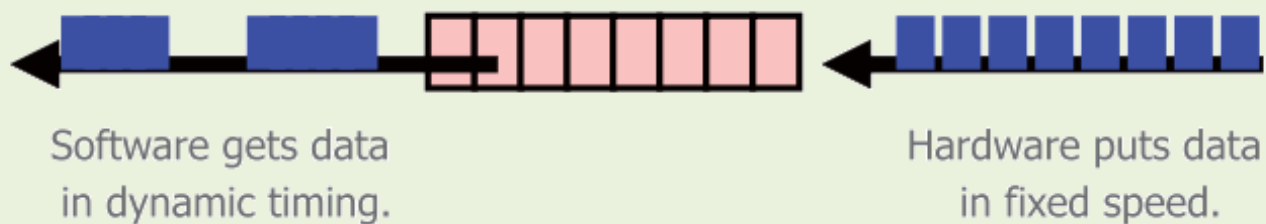

VXC-1x8U/PCIe-S1x8 series cards are equipped with a large 256-byte hardware FIFO for each port. A large hardware FIFO is useful for preventing data loss if the loading on your system is heavy, e.g. while running a multi-task operating system, such as Windows, or Linux, etc.

Self-Tuner

The VXC-148U/PCIe-S148 card is equipped with an internal “Self-Tuner” chip that is used to automatically control the direction of the transmission and receiving of signals on the RS-485 ports.

Without the help inclusion of the Self-Tuner, the RS-485 transmitter would need to be manually enabled before transmitting, and then disabled once the transmission is complete. The timing method that is used to enable and disable the transmitter (direction control) is major source of many communication problems, and is very difficult to rectify.

The built-in Self-Tuner embedded on the VXC-148U/PCIe-S148 card can help effectively any issues related to direction control and also simplifies the software programming required for communication applications.

Automatically Select COM Port Numbers

The VXC-1x8U/PCIe-S1x8 series card support drivers choose an available COM port number automatically. Users can specify the COM port number of the VXC-1x8U/PCIe-S1x8 card under software control.

Various Accessories

There are a lot of optional accessories for the VXC-1x8U and PCIe-S1x8 multiport series cards, such as RS-232 cables and daughter boards. These tools make wiring much easily than ever.

1.2 Specifications

1.2.1 VXC-118U/PCIe-S1x8

Models	PCIe-S118	VXC-118U
Communication Port		
COM1 - COM8	RS-232 (TxD, RxD, RTS, CTS, DTR, DSR, DCD, GND)	
UART	16c950 compatible	
Baud Rate	2400 – 921600 bps	50 - 115200 bps
Data Bits	5, 6, 7, 8	
Stop Bits	1, 1.5, 2	
Parity	None, Even, Odd, Mark, Space	
FIFO	Internal 256 bytes	
General		
Bus Type	PCI Express x1	Universal PCI, 3.3 V/5 V, 33 MHz, 32-bit
COM-Selector	No	
Connector	DB-62 (Female)	
Power Consumption	120 mA @ 5 V	
Operating Temperature	0°C ~ +60°C	
Storage Temperature	-20°C ~ +70°C	
Humidity	0 ~ 90% RH, non-condensing	
Dimensions (L x W x D)	131 mm x 121 mm x 22 mm	132 mm x 121 mm x 22 mm

1.2.2 VXC-148U/PCIe-S148







Models		PCIe-S148	VXC-148U
Communication Port			
COM1 - COM8	RS-422/485		The RS-422 and RS-485 Cannot be used simultaneously.
	RS-422		RS-422 (TxD+, TxD-, RxD+, RxD-, GND)
	RS-485	2-Wire	RS-485 (Data+, Data-, GND)
		Bias Resistor	Yes, 1 K Ω
	Nodes	256 (max.)	
UART		16c950 compatible	
Baud Rate		2400 –921600 bps	50 - 115200 bps
Data Bits		5, 6, 7, 8	
Stop Bits		1, 1.5, 2	
Parity		None, Even, Odd, Mark, Space	
FIFO		Internal 256 bytes	
General			
Bus Type		PCI Express x1	Universal PCI, 3.3 V/5 V, 33 MHz, 32-bit
COM-Selector		No	
Connector		DB-62 (Female)	
Power Consumption		120 mA @ 5 V	
Operating Temperature		0°C ~ +60°C	
Storage Temperature		-20°C ~ +70°C	
Humidity		0 ~ 90% RH, non-condensing	
Dimensions (L x W x D)		115.7 mm x 93.1 mm x 22 mm	



Note:

The combination of 5 data bits and 1.5 stop bits is not supported for a Baud Rate of 921,600 bps for VXC-148U only.

1.3 Options

Item & Description	VXC-118U	VXC-148U	PCle-S118	PCle-S148
 <p>CA-9-6210 DB-62 Male(D-sub) to 8-Port DB-9 Male(D-sub) Cable 1 m (180 °)</p>	✓	✓	✓	✓
 <p>CA-PC09F 9-pin Female D-sub Connector with Plastic Cover</p>	✓	✓	✓	✓
 <p>CA-PC62M 62-pin Male D-sub Connector with Plastic Cover</p>	✓	✓	✓	✓
 <p>DN-09-2/DN-09-2F I/O Connector Block with DIN-Rail Mounting and two 9-pin Male Headers</p>	✓	✓	✓	✓
 <p>CA-0910F 9-pin Female-Female D-sub Cable, 1 m</p>	✓	✓	✓	✓
 <p>CA-0915 9-pin Male-Female D-sub Cable, 1.5 M</p>	✓	✓	✓	✓

2. Hardware Configuration

2.1 Board Layout

2.1.1 VXC-118U/VXC-148U

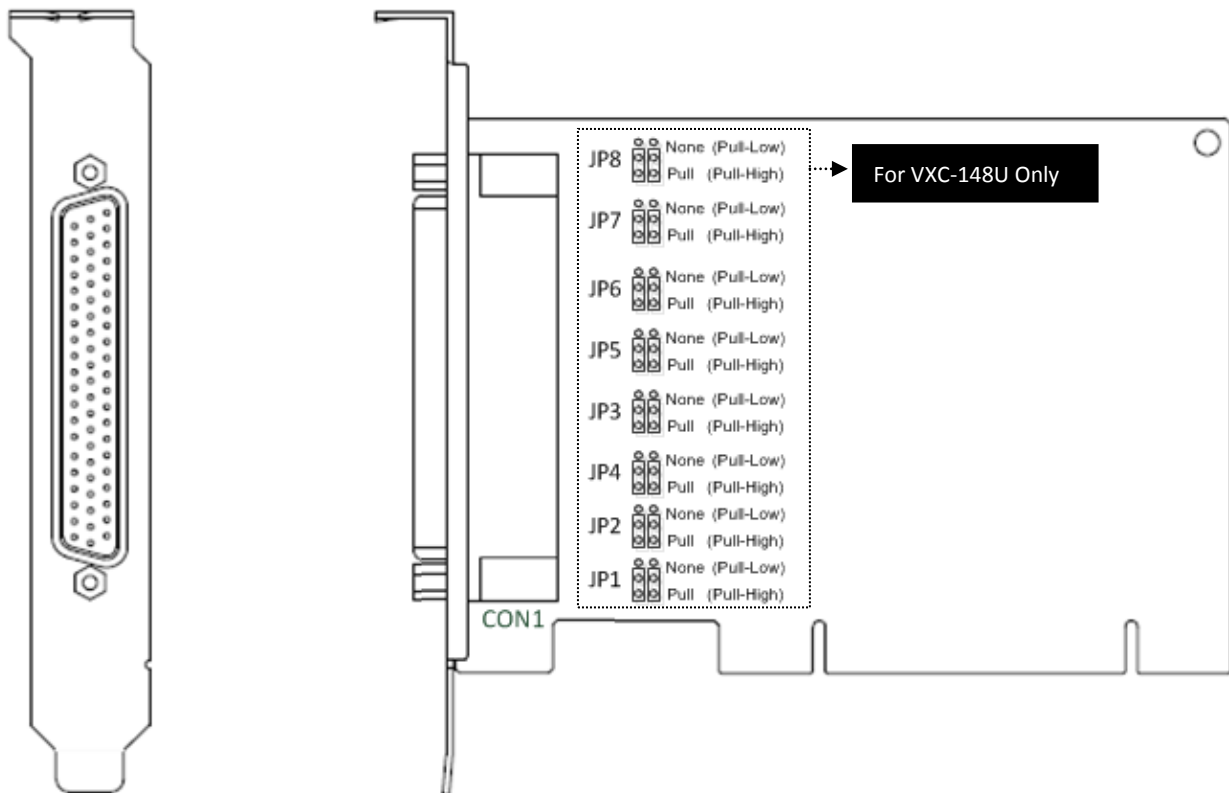

Item	Description
CON1	RS-232 or RS-422/RS-485 Signal. For more detailed information regarding the pin assignments for the VXC-1x8U series card, refer to Section 2.3 Pin Assignments .
JPx	The VXC-148U supports pull-high/low jumpers allow the Port1/2/3/4/5/6/7/8 can be selected to either pull-high or pull-low via placement of the JP1/2/3/4/5/6/7/8 jumpers. The JP1/2/3/4/5/6/7/8 default settings: pull-high.

2.1.2 PCIe-S118/PCIe-S148

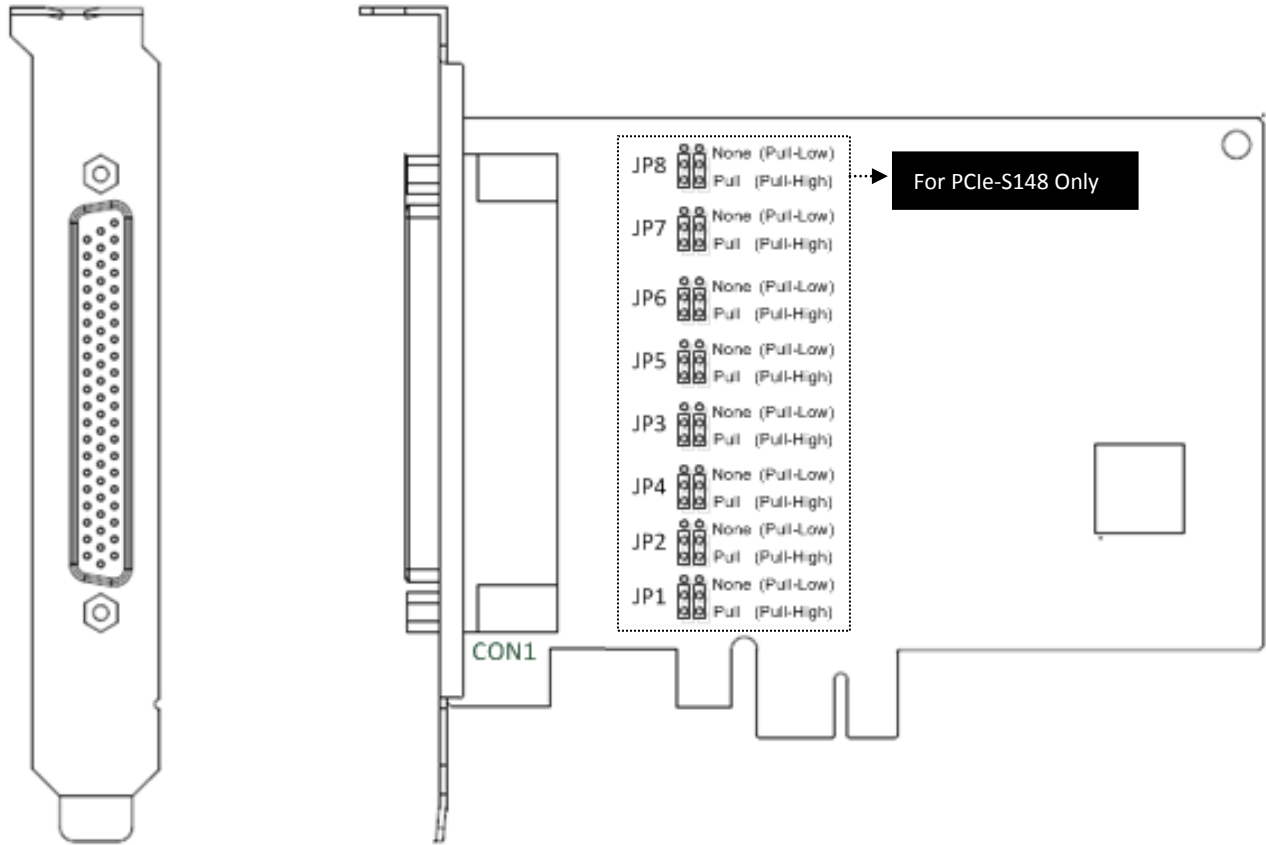

Item	Description
CON1	RS-232 or RS-422/RS-485 Signal. For more detailed information regarding the pin assignments for the PCIe-S1x8 series card, refer to Section 2.3 Pin Assignments .
JPx	The PCIe-S148 supports pull-high/low jumpers allow the Port1/2/3/4/5/6/7/8 can be selected to either pull-high or pull-low via placement of the JP1/2/3/4/5/6/7/8 jumpers. The JP1/2/3/4/5/6/7/8 default settings: pull-high.

2.2 Wiring Notes for RS-232/422/485

2.2.1 RS-232 Wiring

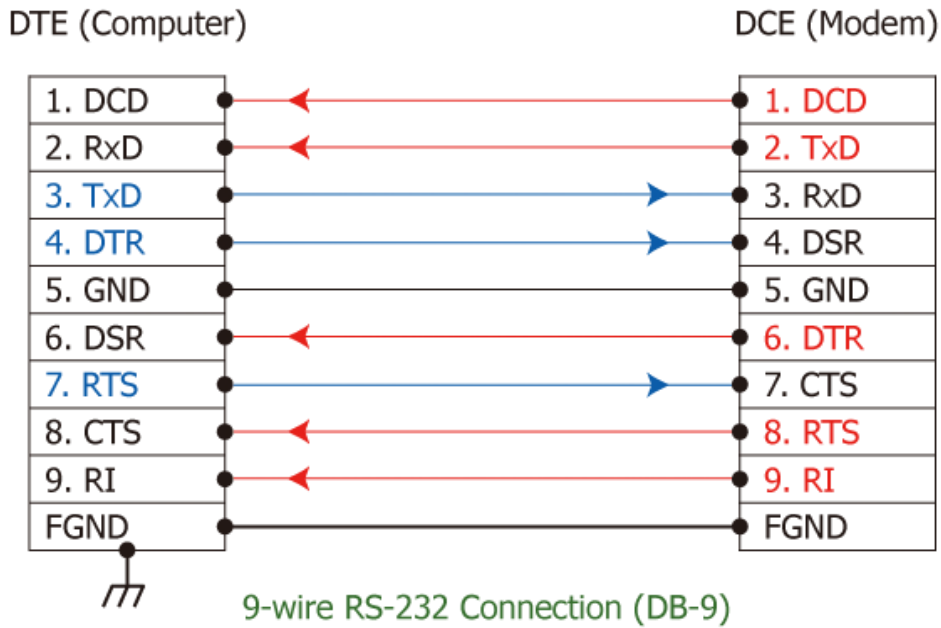

Note: FGND is the frame ground that is soldered to the metal shield on the DB-9 cable.

2.2.2 RS-485 Wiring

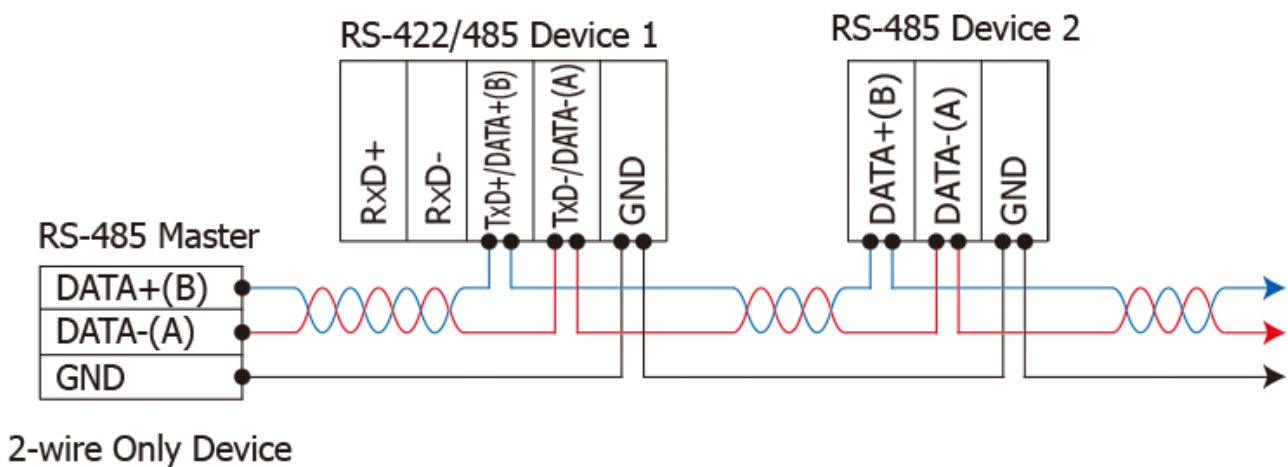

2.2.3 RS-422 Wiring

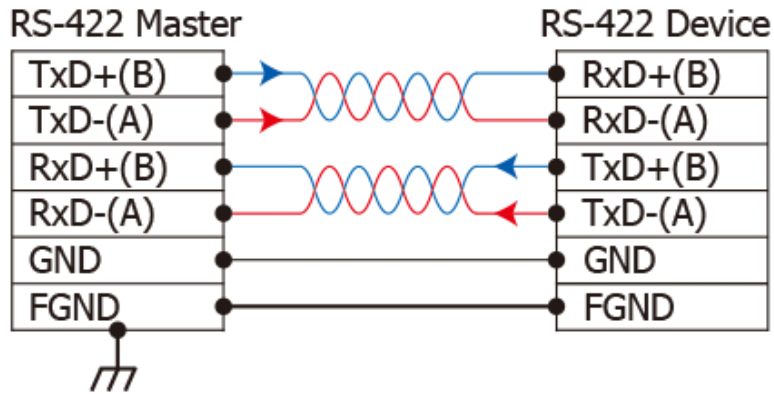

Note:

1. Usually, you have to connect all signal grounds of RS-422/485 devices together to reduce common-mode voltage between devices.
2. Twisted-pair cable must be used for the DATA+/- wires.
3. Both two ends of the cable may require a termination resistor connected across the two wires (DATA+ and DATA-). Typically 120 Ω resistors are used.
4. The Data+ and B pins are positive-voltage pins, and Data- and A pins are negative-voltage pins in the above figure. The B/A pins may be defined in another way depending on devices, please check it first.

2.3 Pin Assignments

2.3.1 VXC-118U/PCIe-S118

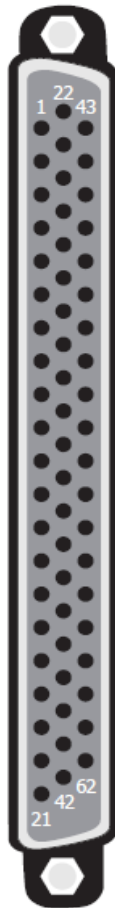

Terminal No.	Pin Assignment	Terminal No.	Pin Assignment	Terminal No.	Pin Assignment
01	TxD_0	22	RxD_0	43	CTS_0
02	DTR_0	23	DSR_0	44	RTS_0
03	RxD_1	24	DCD_0	45	GND
04	DSR_1	25	TxD_1	46	CTS_1
05	DCD_1	26	DTR_1	47	RTS_1
06	TxD_2	27	RxD_2	48	CTS_2
07	DTR_2	28	DSR_2	49	RTS_2
08	RxD_3	29	DCD_2	50	GND
09	DSR_3	30	TxD_3	51	CTS_3
10	DCD_3	31	DTR_3	52	RTS_3
11	RxD_4	32	GND	53	CTS_4
12	DSR_4	33	TxD_4	54	RTS_4
13	DCD_4	34	DTR_4	55	GND
14	TxD_5	35	RxD_5	56	CTS_5
15	DTR_5	36	DSR_5	57	RTS_5
16	RxD_6	37	DCD_5	58	GND
17	DSR_6	38	TxD_6	59	CTS_6
18	DCD_6	39	DTR_6	60	RTS_6
19	RxD_7	40	GND	61	CTS_7
20	DSR_7	41	TxD_7	62	RTS_7
21	DCD_7	42	DTR_7		

CON1



Terminal No.	Pin Assignment
01	DCD
02	RxD
03	TxD
04	DTR
05	GND
06	DSR
07	RTS
08	CTS
09	-

RS-232 Female DB-62 to Male DB-9 Connector

2.3.2 VXC-148U/PCIe-S148

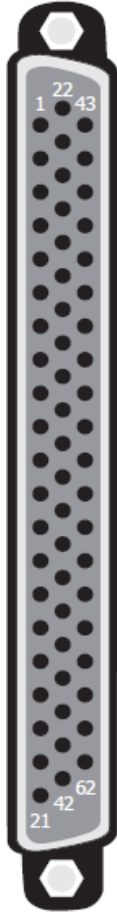

Terminal No.	Pin Assignment	Terminal No.	Pin Assignment	Terminal No.	Pin Assignment
01	RxD0+	22	TxD0+/Data0+	43	-
02	RxD0-	23	-	44	-
03	TxD1+/Data1+	24	TxD0-/Data0-	45	GND
04	-	25	RxD1+	46	-
05	TxD1-/Data1-	26	RxD1-	47	-
06	RxD2+	27	TxD2+/Data2+	48	-
07	RxD2-	28	-	49	-
08	TxD3+/Data3+	29	TxD2-/Data2-	50	GND
09	-	30	RxD3+	51	-
10	TxD3-/Data3-	31	RxD3-	52	-
11	TxD4+/Data4+	32	GND	53	-
12	-	33	RxD4+	54	-
13	TxD4-/Data4-	34	RxD4-	55	GND
14	RxD5+	35	TxD5+/Data5+	56	-
15	RxD5-	36	-	57	-
16	TxD6+/Data6+	37	TxD5-/Data5-	58	GND
17	-	38	RxD6+	59	-
18	TxD6-/Data6-	39	RxD6-	60	-
19	TxD7+/Data7+	40	GND	61	-
20	-	41	RxD7+	62	-
21	TxD7-/Data7-	42	RxD7-		

CON1

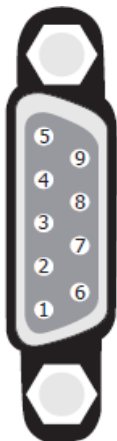

Terminal No.	Pin Assignment
01	TxD-/Data-
02	TxD+/Data+
03	RxD+
04	RxD-
05	GND
06	-
07	-
08	-
09	-

RS-422/485 Female DB-62 to Male DB-9 Connector

3. Hardware Installation



Note:

As certain operating systems, such as Windows XP may require the computer to be restarted after a new driver is installed, it is recommended that the driver is installed first, which will reduce the installation time.

To install the VXC-1x8U/PCIe-S1x8 series card, follow the procedure described below:

Step 1: Install the driver for the VXC-1x8U/PCIe-S1x8 series card on your computer.

For detailed information regarding driver installation, refer to [Chapter 4 Software Installation](#).



Step 2: Shut down and switch off the power to the computer, and then disconnect the power supply.

Step 3: Remove the cover from the computer.

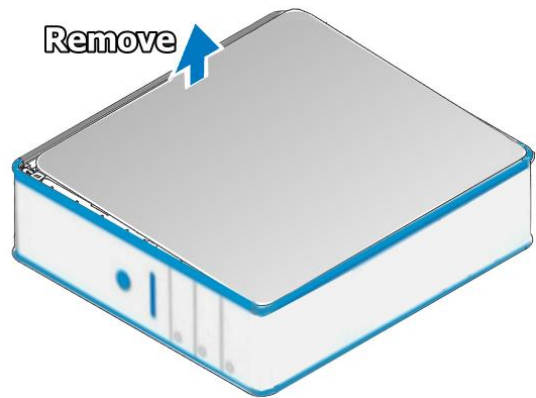

Step 4: Select an empty PCI/PCI Express slot.

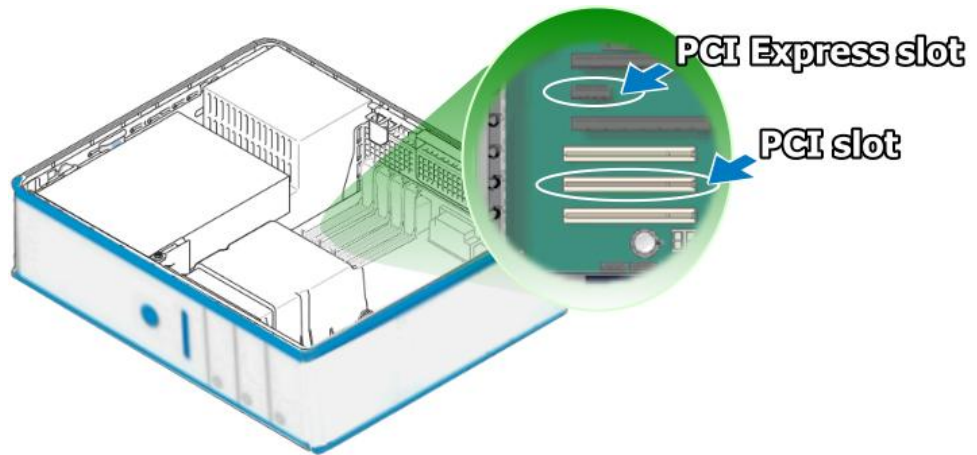

Step 5: Unscrew and remove the PCI/PCI Express slot cover from the computer case.

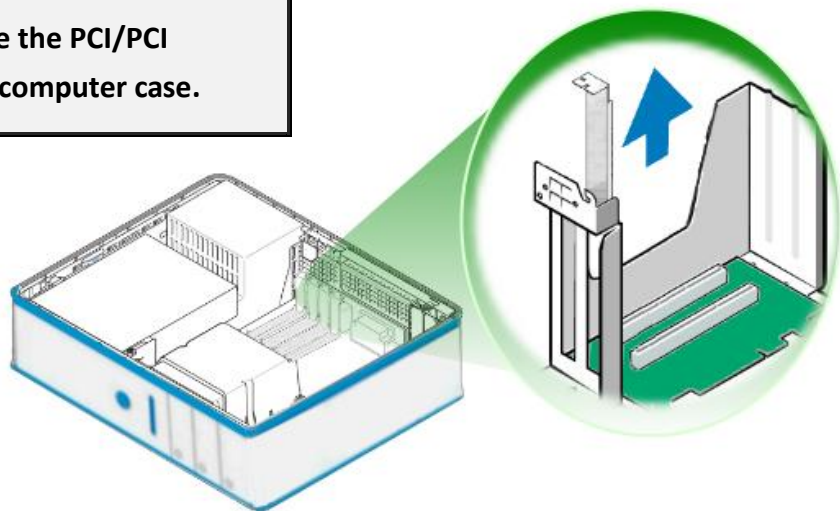

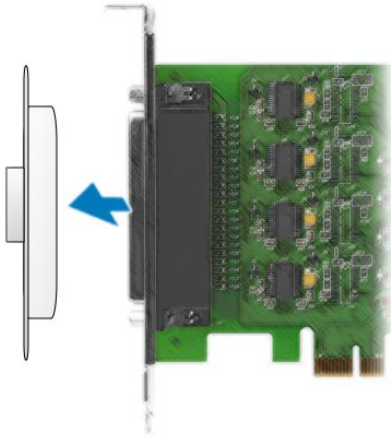

Step 6: Remove the connector cover from the VXC-1x8U/PCIe-S1x8 series card.

Step 7: Carefully insert the VXC-1x8U/PCIe-S1x8 series card into the PCI/PCI Express slot by gently pushing down on both sides of the card until it slides into the PCI connector.

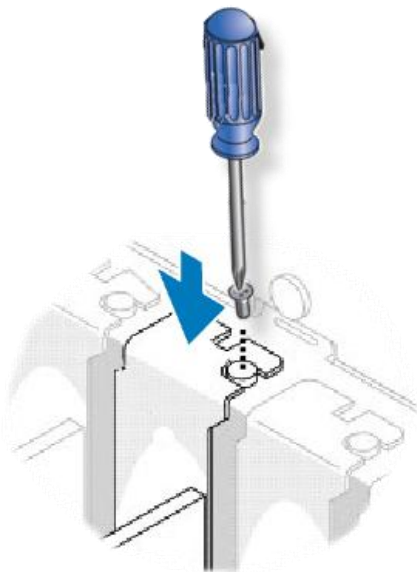
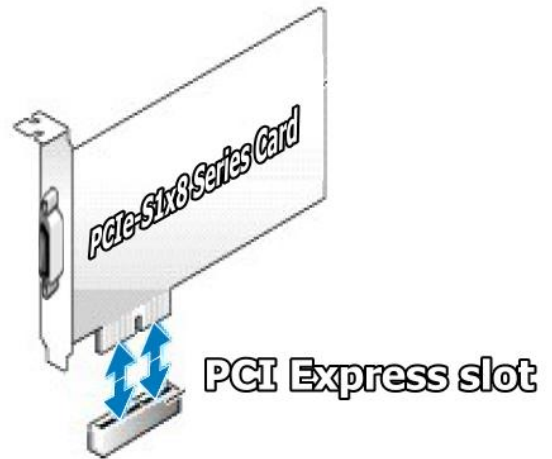
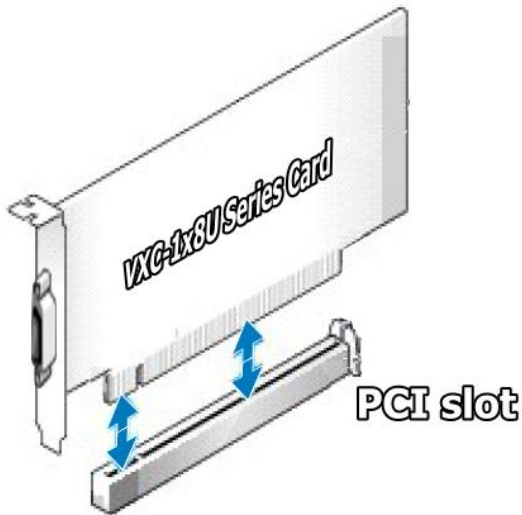

Step 8: Confirm that the card is correctly inserted in the motherboard, and then secure the VXC-1x8U/PCIe-S1x8 series card in place using the retaining screw that was removed in Step 5.

Step 9: Replace the covers on the computer.

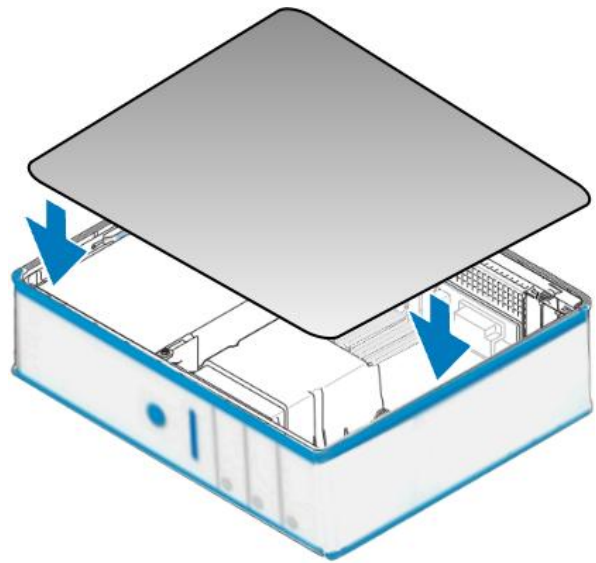

Step 10: Re-attach any cables, insert the power cord and then switch on the power to the computer.

Once the computer reboots, follow the onscreen messages to complete the Plug and Play installation process. For more information, refer to [Chapter 4 Software Installation](#).



4. Software Installation

The VXC-1x8U/PCle-S1x8 series card can be used with both 32 and 64-bit Windows XP/2003/Vista/7/8 systems, and also supports Plug and Play (PnP) functions for easy installation. This chapter provides detailed description of how to install the drivers for the VXC-1x8U/PCle-S1x8 series card.

4.1 Obtaining the Driver Installer Package

The installer package for the ICP DAS VXC-1x8U/PCle-S1x8 series driver can be obtained from either the companion CD-ROM, the FTP site, or the ICP DAS web site. The locations and addresses are shown below:



CD:\\ NAPDOS\\MultiPort\\Windows\\



<ftp://ftp.icpdas.com/pub/cd/iocard/pci/napdos/multiport/windows/>



<http://ftp.icpdas.com/pub/cd/iocard/pci/napdos/multiport/windows/>

Install the appropriate driver for your VXC-1x8U/PCle-S1x8 series card.

Driver Name	Suitable Multiport Card
VXC_1x8U_Win_Setup_xxx.exe	for the VXC-118U and VXC-148U.
PCle_S1x8_Win_Setup_xxx.exe	for the PCle-S118 and PCle-S148.

4.2 Installing VXC-1x8U Series Driver

Follow the process described below to set up the software for the VXC-118U and VXC-148U card:

Step 1: Double-click the “VXC_1x8_Win_Setup_xxxx” application to install the driver.

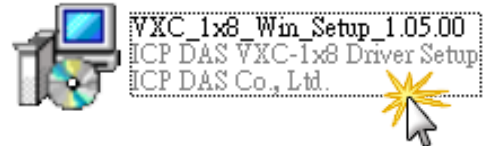

Step 2: When the Setup Wizard screen is displayed, click the “Next>” button to installation.

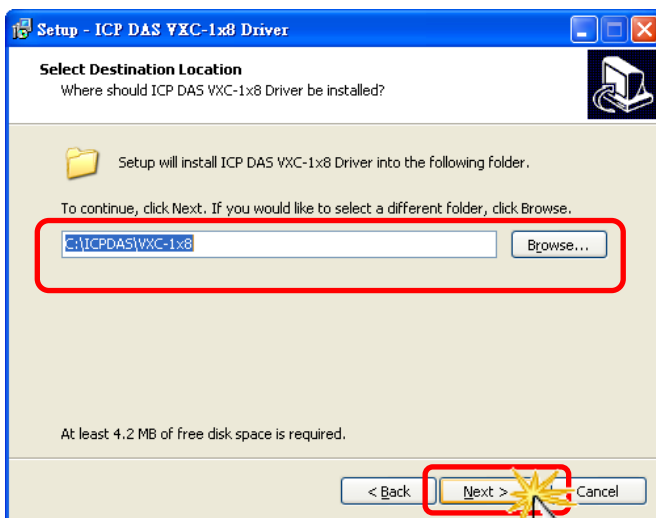
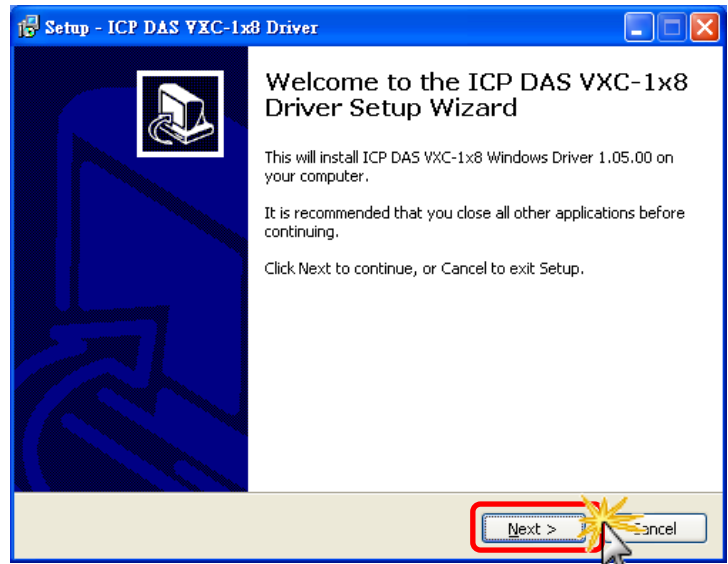

Step 3: Select the folder where the drivers are to be install. The default path is C:\ICPDAS\VXC-1x8. But if you wish to install the drivers to a different location, click the “Browse...” button and select the relevant folder and then click the “Next>” button.

Step 4: The Setup Wizard will then display a warning message asking you to confirm that you wish to install the device software. Refer to the figures below for details.

For Windows XP/2003 (32-/64-bit)

In the **“Hardware Installation”** dialog box, click the **“Continue Anyway”** button.



Note:

The warning will be displayed several times. In all cases, click the **“Continue Anyway”** button to proceed with the installation.

For Windows Vista/7/8 (32-bit/64-bit)

In the **“Windows Security”** dialog box, check the **“Always trust software from ICP DAS Co., Ltd.”** Checkbox and click the **“Install”** button.



Note:

This warning will be displayed several times. All cases, click the **“Install”** button to proceed with the installation.

Step 5: Once the driver has been installed, the Setup Wizard will be displayed to advise that the computer must be restarted in order to complete the installation. Select the **“No, I will restart the computer later”** option, and then click the **“Finish”** button to exit the Wizard.

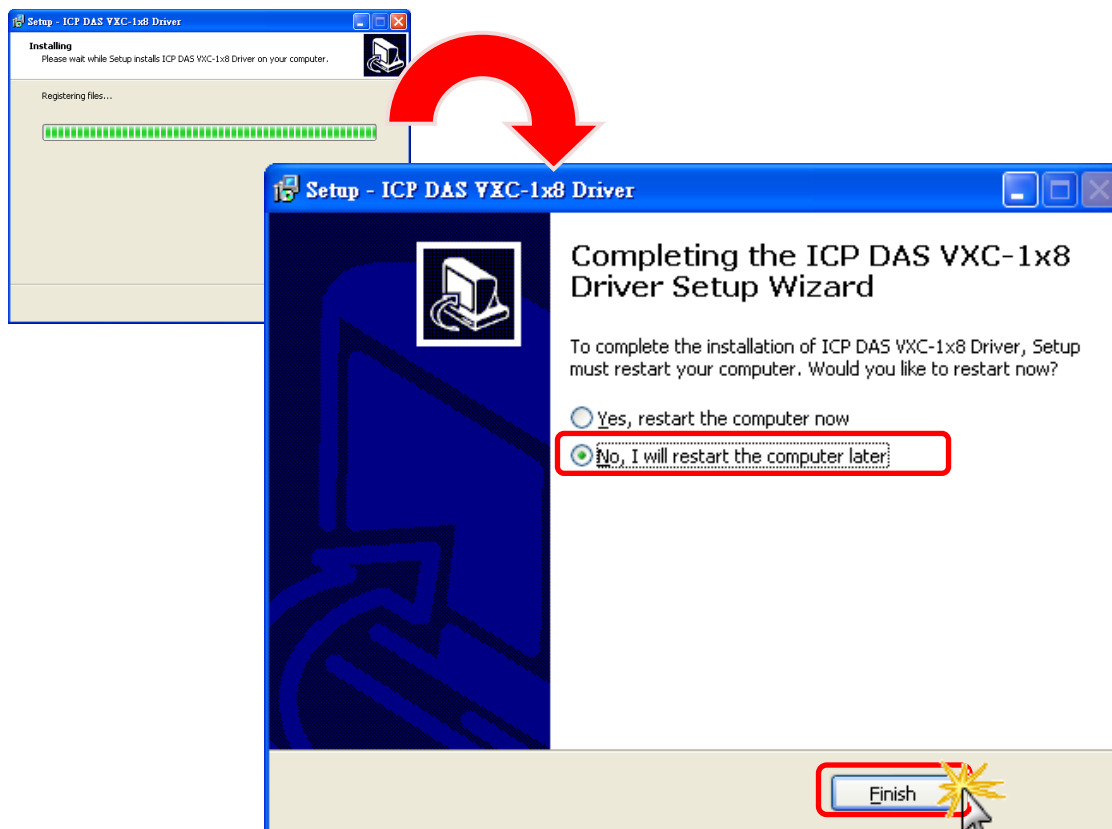

4.3 Installing PCIe-S1x8 Series Driver

Follow the process described below to set up the software for the PCIe-S118 and PCIe-S148 card:

Step 1: Double-click the “**PCIe_S1x8_Win_Setup_xxxx**” application to install the driver.

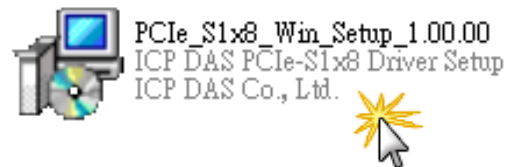

Step 2: When the Setup Wizard screen is displayed, click the “**Next>**” button to installation.

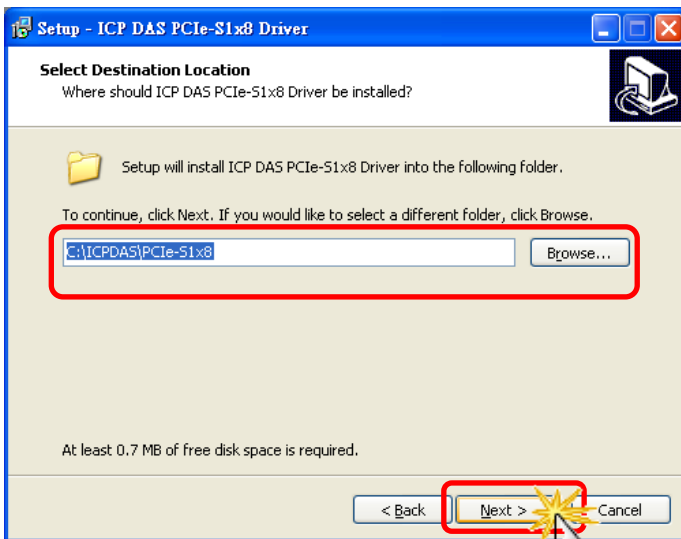
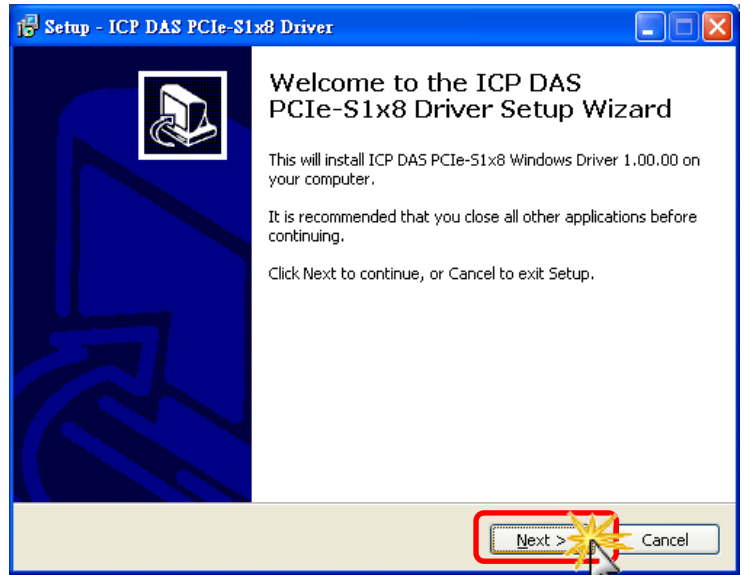

Step 3: Select the folder where the drivers are to be install. The **default path is C:\ICPDAS\PCIe-S1x8**. But if you wish to install the drivers to a different location, click the “**Browse...**” button and select the relevant folder and then click the “**Next>**” button.

Step 4: In the installation process, the Command Prompt windows will be displayed, don't care.

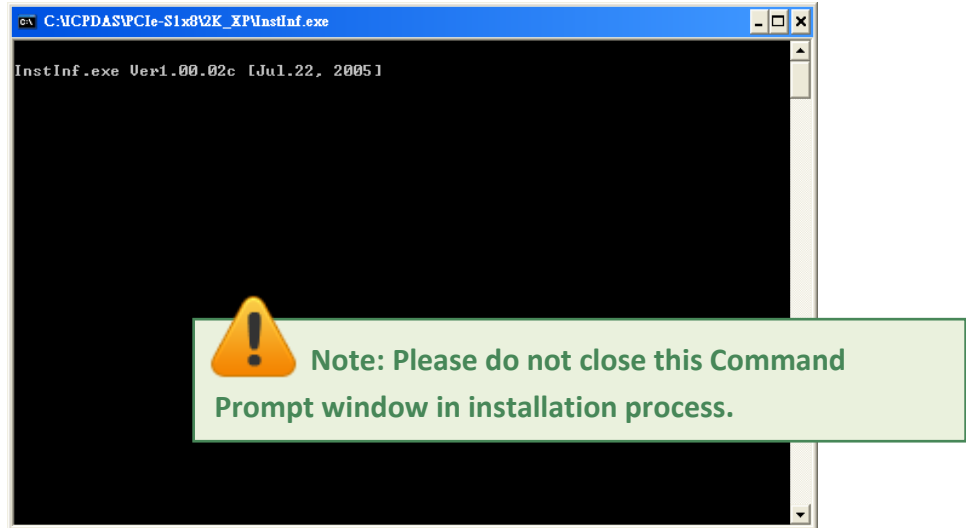

Step 5: Once the driver has been installed, the Setup Wizard will be displayed to advise that the computer must be restarted in order to complete the installation. Select the “No, I will restart the computer later” option, and then click the “Finish” button to exit the Wizard.

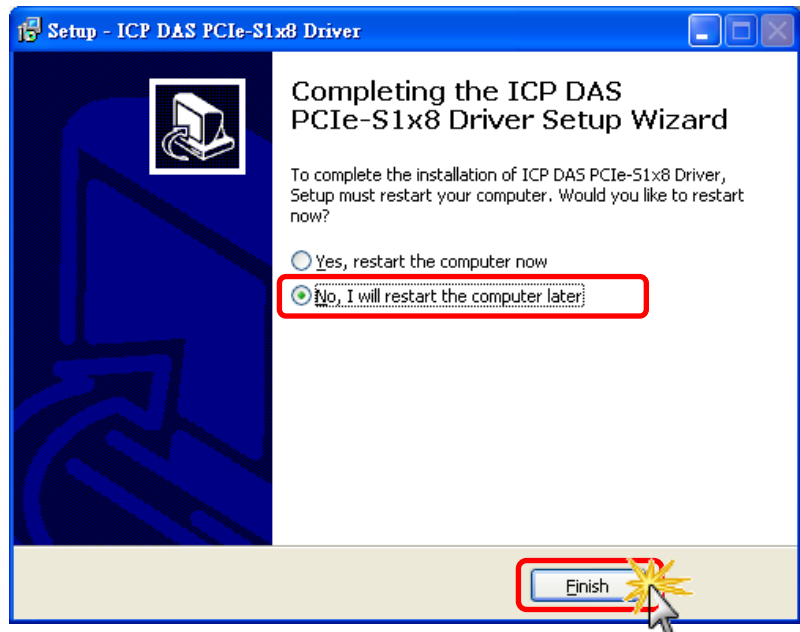

4.4 PnP Driver Installation

Step 1: Correctly shut down and power off your computer and disconnect the power supply, and then install the VXC-1x8U/PCIe-S1x8 series card into the computer.

For detailed information regarding installation of the VXC-1x8U/PCIe-S1x8 series card, refer to [Chapter 3 Hardware Installation](#).

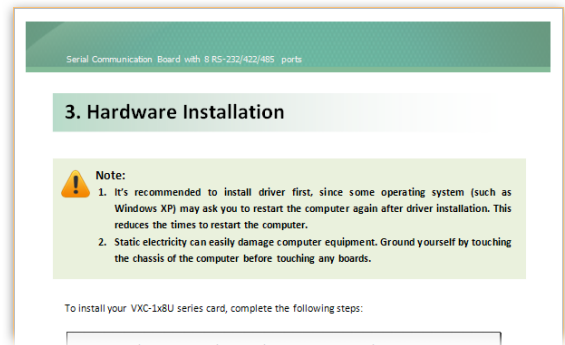

Step 2: Power on the computer and complete the Plug and Play installation.



Note: More recent operating systems, such as Windows Vista/7/8 will automatically detect the new hardware and install the necessary drivers etc., so Steps 3 to 5 can be skipped.

Step 3: When the "Found New Hardware Wizard" is displayed, select "Install the software automatically [Recommended]" option and then click the "Next>" button.

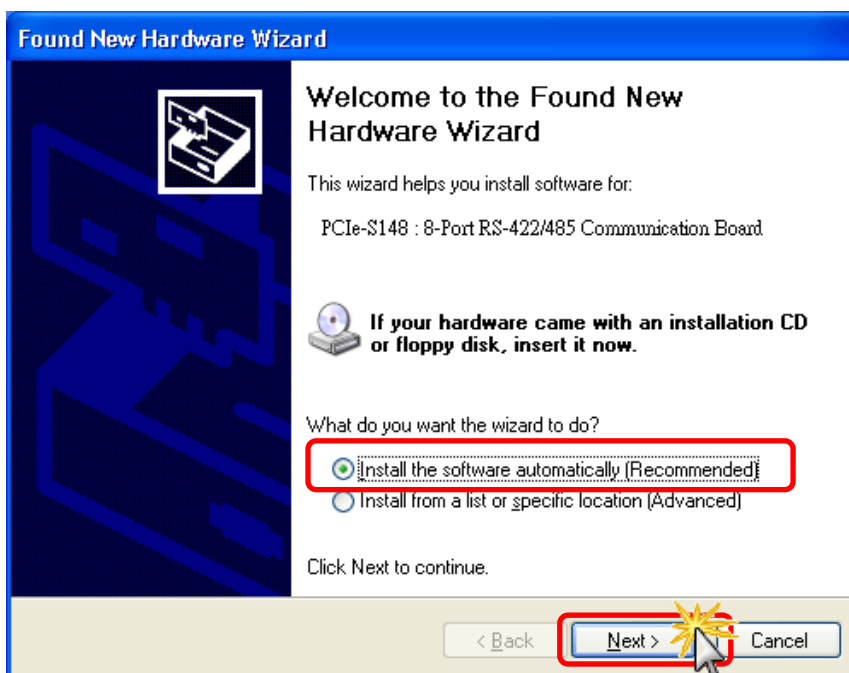

Step 4: The “Found new Hardware Wizard” will be displayed to advise that the software installation has been completed. Click the “Finish” button to exit the Wizard.

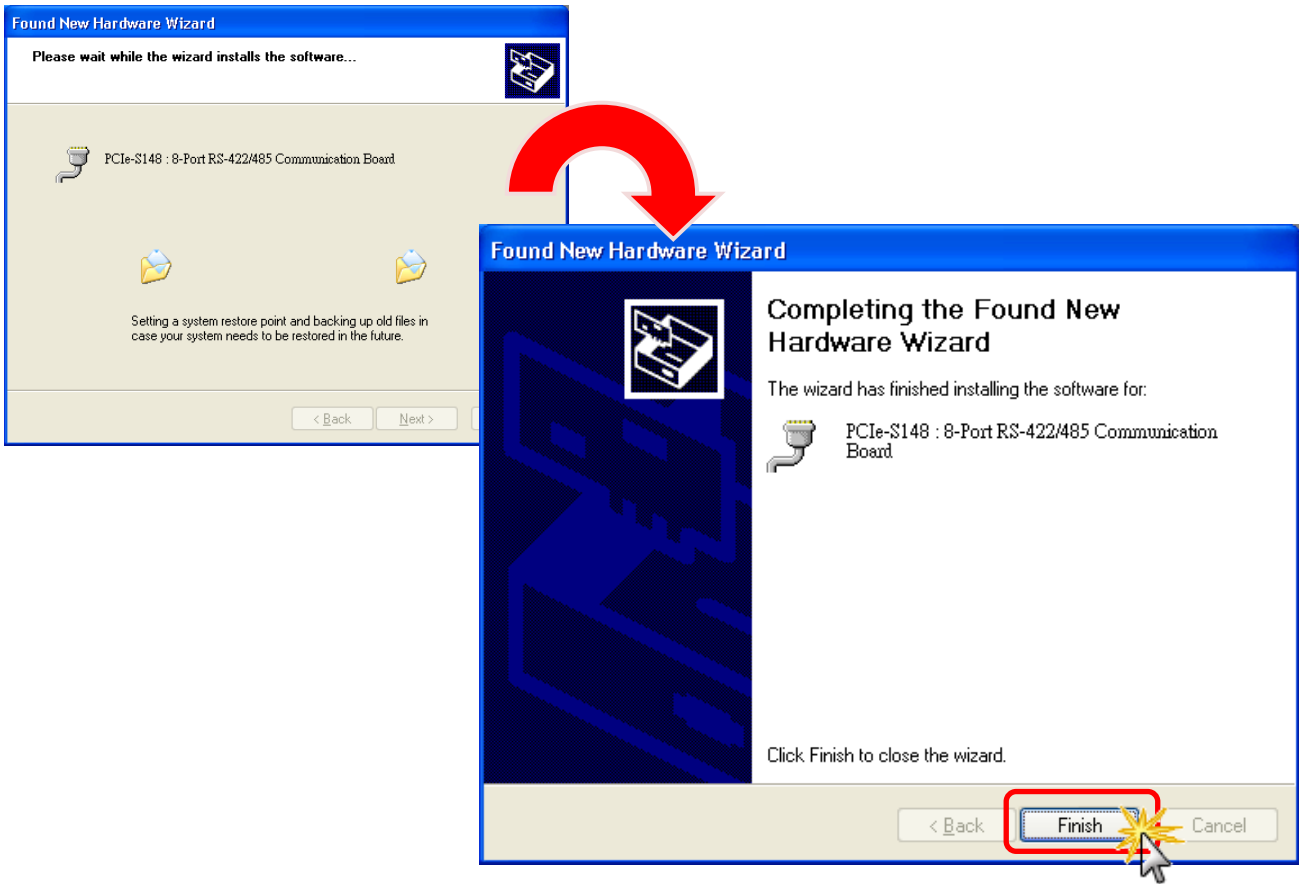

Step 5: If the “Found New Hardware Wizard” dialog box is displayed again, repeat **Steps 3 and 4** to complete the installation for all COM ports.



4.5 Verifying the Installation

To verify that the driver was correctly installed, use the Windows **Device Manager** to view and update the device drivers installed on the computer, and to ensure that the hardware is operating correctly. The following is a description of how access the Device Manager in each of the major versions of Windows. Refer to the appropriate description for the specific operating system to verify the installation.

4.5.1 Accessing Windows Device Manager

■ Windows XP

Step 1: Click the **“Start”** button and then point to **“Settings”** and click **“Control Panel”**. Double-click the **“System”** icon to open the **“System Properties”** dialog box.

Step 2: Click the **“Hardware”** tab, and then click the **“Device Manager”** button.

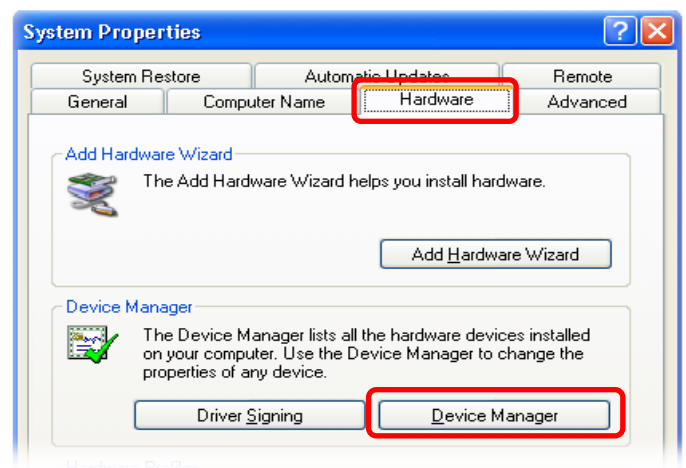

■ Windows Server 2003

Step 1: Click the **“Start”** button and point to **“Administrative Tools”**, and then click the **“Computer Management”** option.

Step 2: Expand the **“System Tools”** item in the console tree, and then click the **“Device Manager”**.

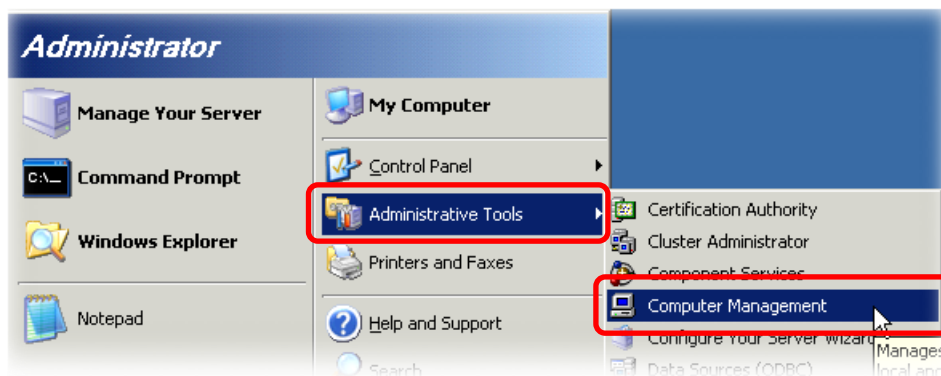

■ Windows Vista/7

Step 1: Click the “Start” button.

Step 2: In the **Search field**, type **Device Manager** and then press Enter.

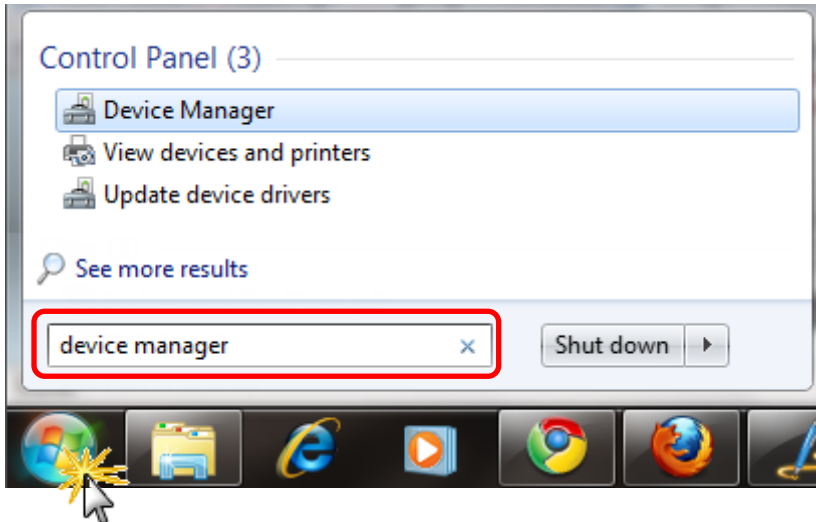

Note that Administrator privileges are required for this operation. If you are prompted for an administrator password or confirmation, enter the password or provide confirmation by clicking the “Yes” button in the User Account control message.

■ Windows 8

Step 1: To display the **Start screen icon** from the desktop view, hover the mouse cursor over the **bottom-left corner** of screen.

Step 2: **Right-click** the Start screen icon and then click “**Device Manager**”.

Alternatively, press **[Windows Key] + [X]** to open the Start Menu, and then select Device Manager from the options list.

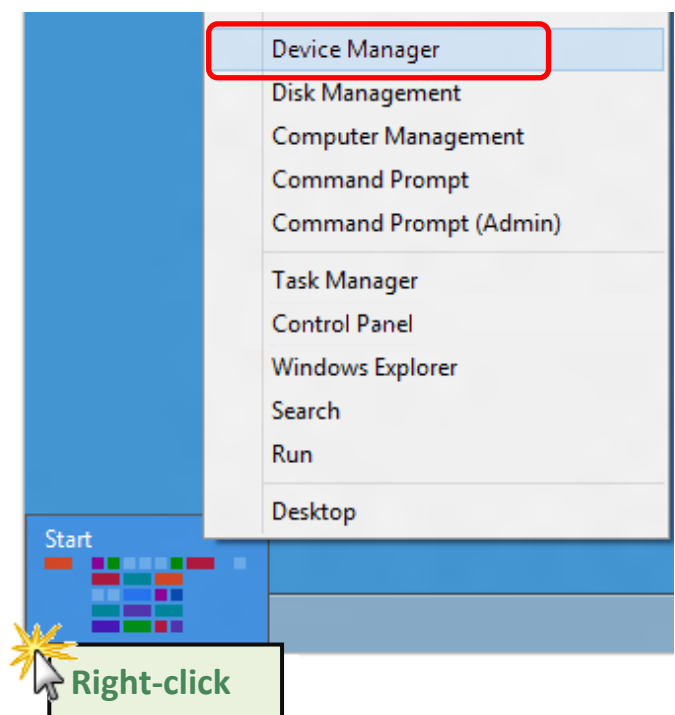

4.5.2 Check the Configuration of the COM Port

Step 3: Verify that the COM Ports for the VXC-1x8/PCIe-S1x8 series card listed correctly.

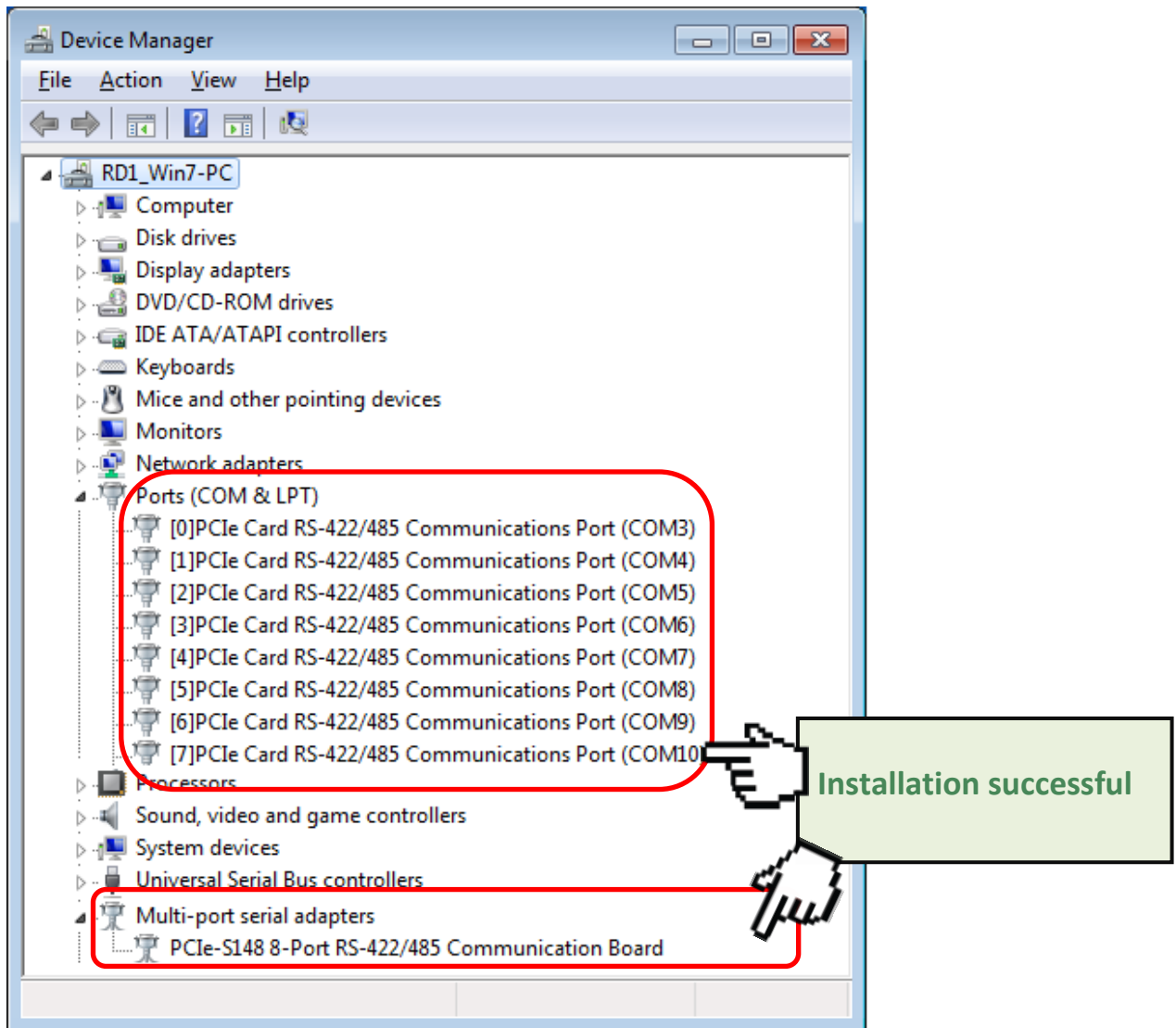

Note: Depending on the operating system, the COM port mapping may be applied automatically.

4.6 Manual COM Port Configuration

The VXC-1x8U and PCIe-S1x8 series card supports 8 RS-232 or RS-422/485 serial ports. Depending on the operating system, COM port mapping may be applied automatically during the hardware and software installation. If the auto-configuration for COM Port is messy or that is not you need, you can change the COM Port mappings by manual configuration.

4.6.1 VXC-118U/VXC-148U

The COM port mapping can be adjusted by using the “ComPortRemap.exe” application, which can be found in the driver installation folder, and then setting the “Select the start com port number” from the options. For detailed configuration steps, please refer to the following:

Step 1: Open the driver installation folder, for example **C:\ICPDAS\VXC-1x8\Driver**, and launch the “ComPortRemap.exe” application.

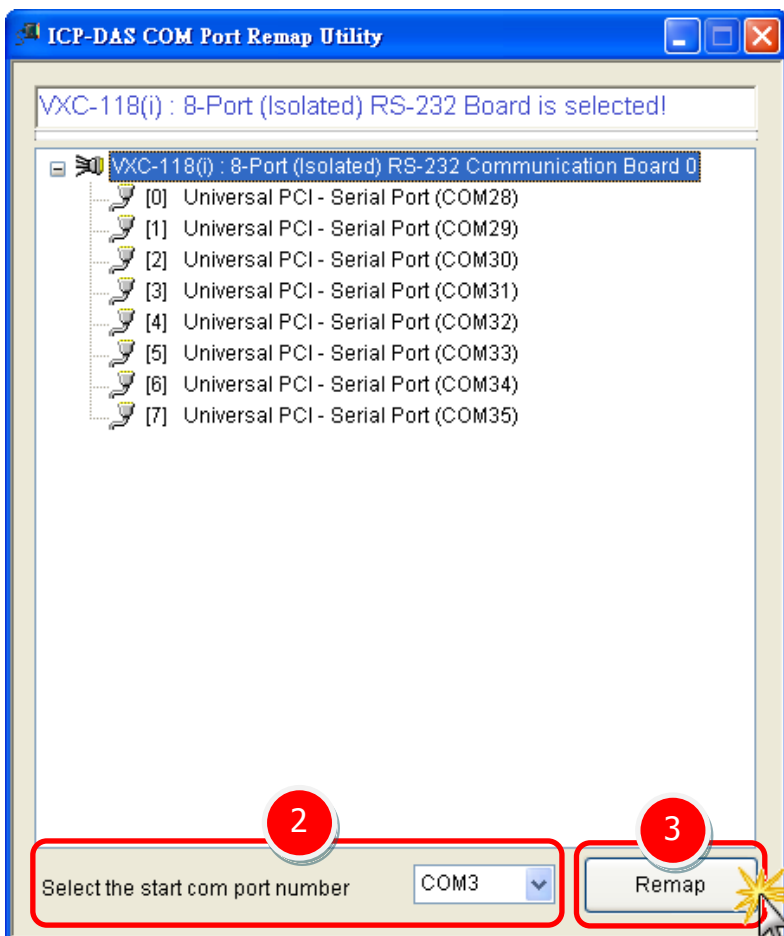

Step 2: Select the starting COM Port number from the drop-down menu.

Step 3: Click the “Remap” button.

Step 4: Once the remapping has been completed, a window will be displayed indicating the new COM Port numbers.

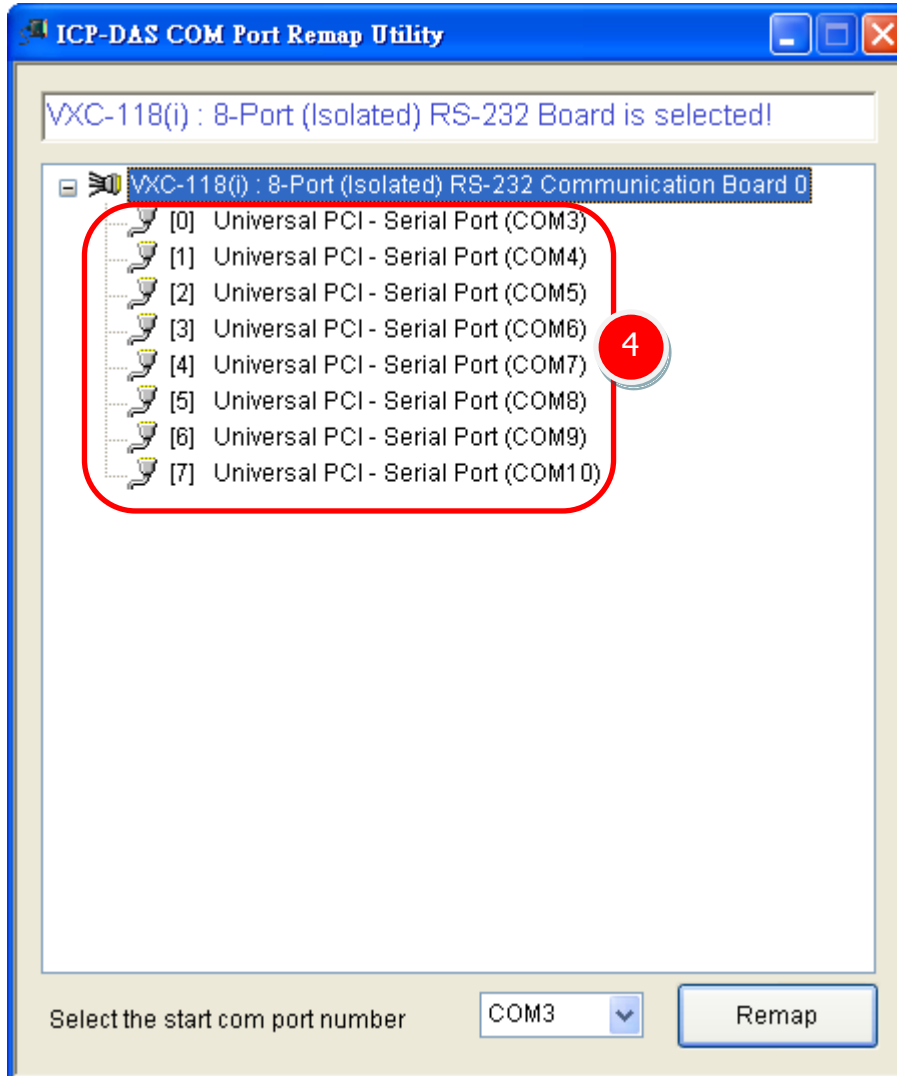

4.6.2 PCIe-S118/PCIe-S148

The COM port mapping can be adjusted depending on the requirements of you. For detailed configuration steps, please refer to the following:

Step 1: Open Windows **Device Manager**. Refer to [Section 4.5.1](#) for more detailed information.

Step 2: **Right click** on the serial port of the PCIe-S1x8 series card.

Step 3: Select the **“Properties”** item from the popup menu and the **“Communications Port (COM n) Properties”** dialog box will be displayed.

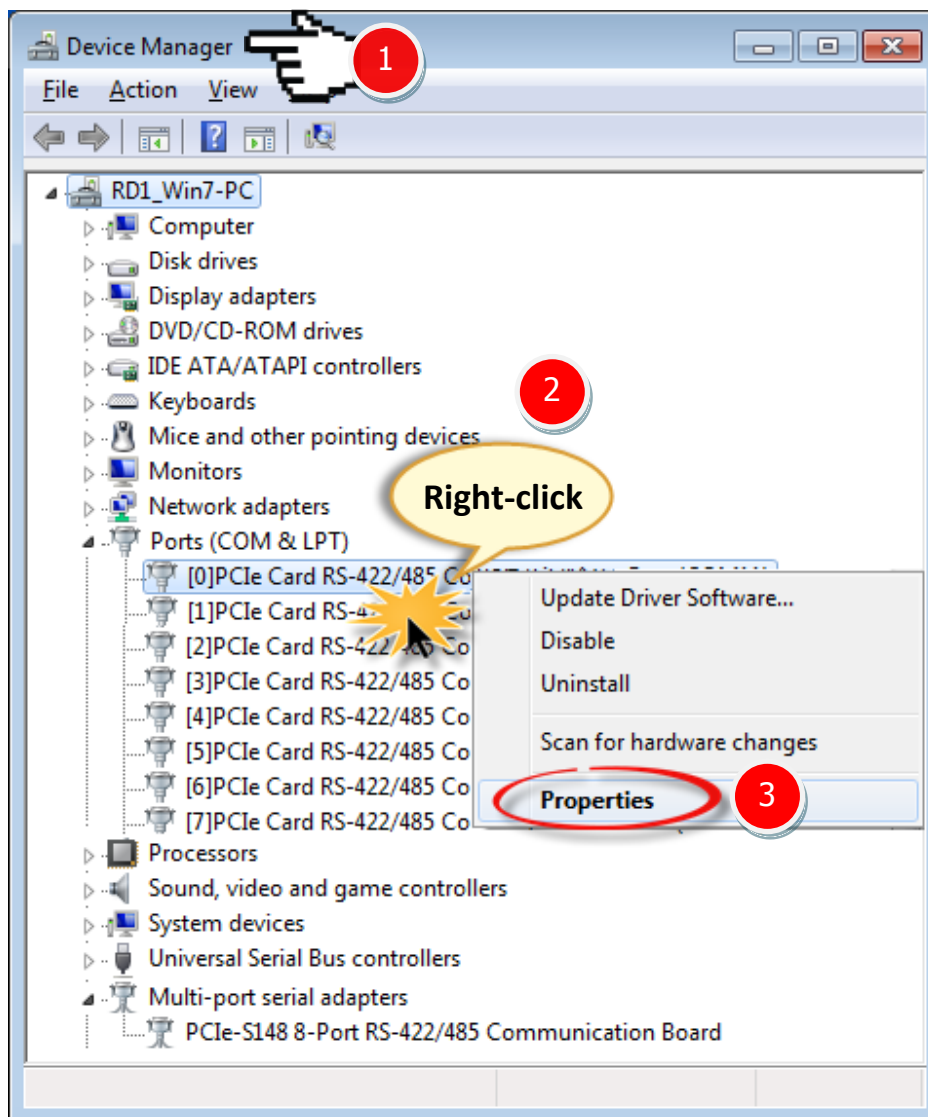

Step 4: Select the **“Port Settings”** item in the **“Communications Port (COM n) Properties”** dialog box.

Step 5: Click the **“Advanced...”** button to open the **“Advanced Settings for COM n”** dialog box.

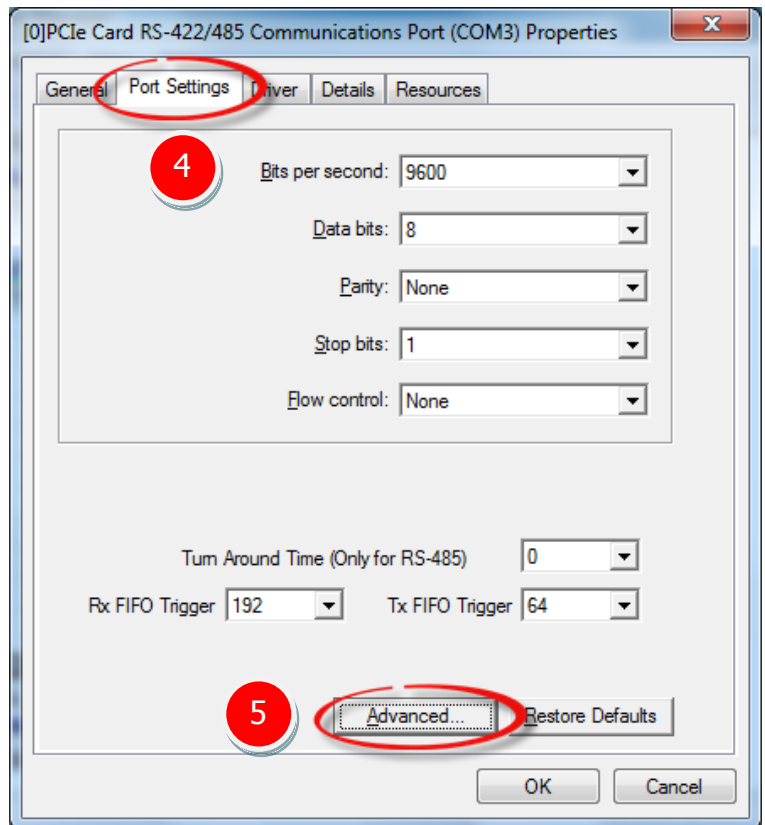

Step 6: In **“Advanced Settings for COM n”** dialog box, select the appropriate **COM Port number** from the **“COM Port Number:”** drop-down options and click the **“OK”** button.

 **Note:** The **COM port display “(in use)”** means this **COM port** is being used. Therefore, please do not select it.

Step 7: Click the **“OK”** button in the **“Communications Port (COM n) Properties”** dialog box.

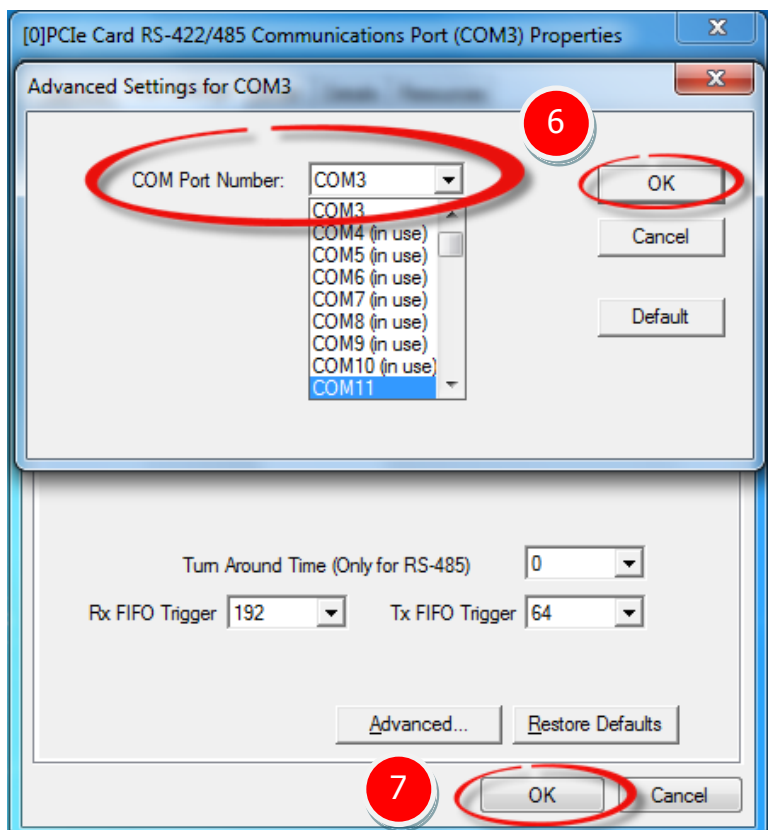

Step 8: Restart your computer to complete the configuration.

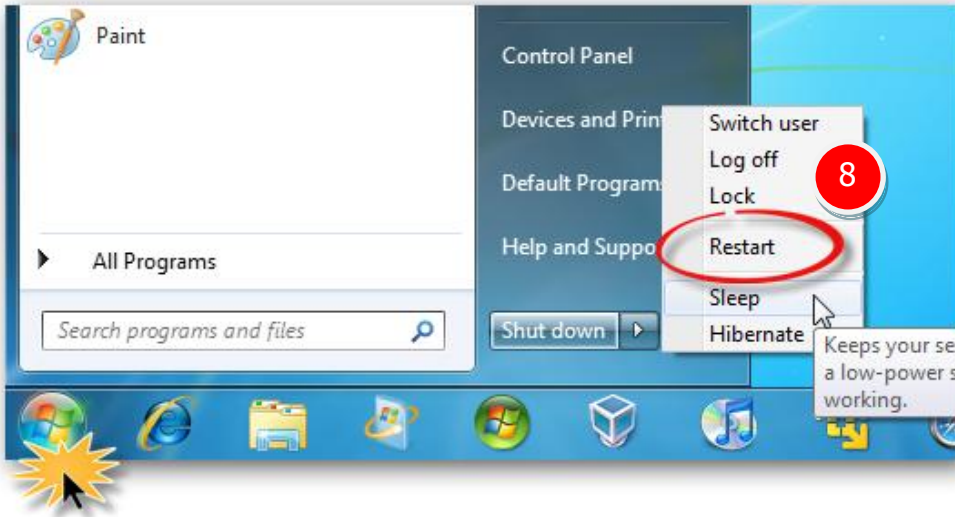

Step 9: Confirm the new COM Ports is correctly displayed.

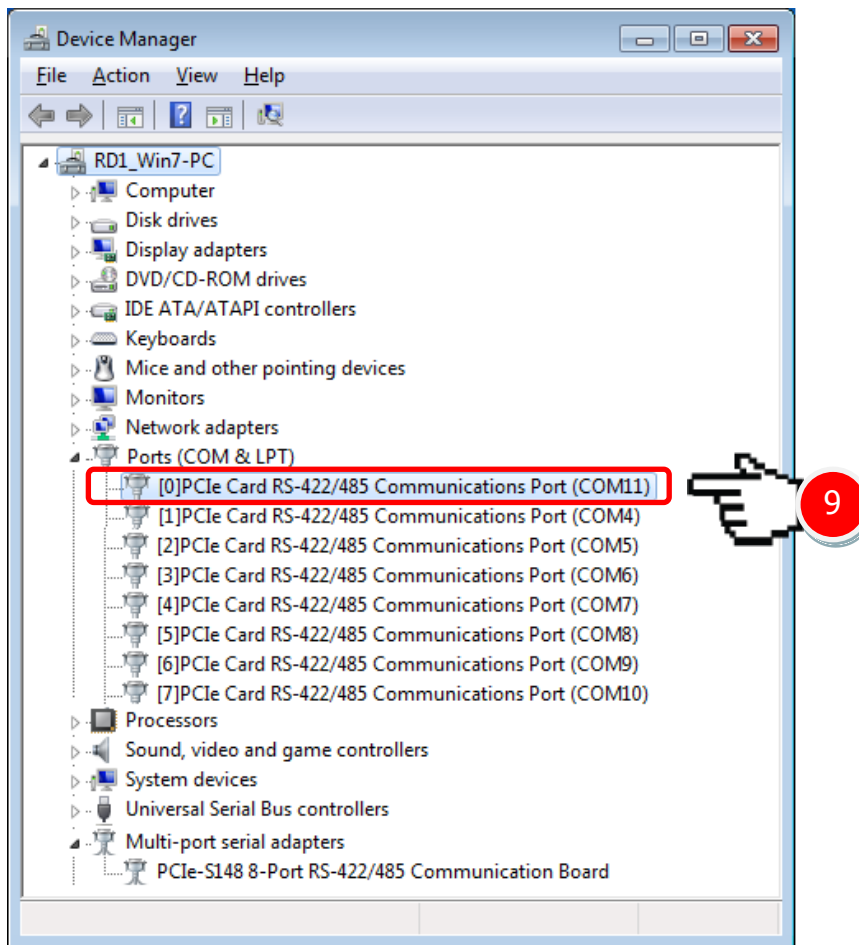

4.7 Uninstalling the Device Driver

The ICP DAS VXC-1x8U/PCIe-S1x8 series card driver includes a utility that allows the software from your computer. To uninstall the software, follow the procedure described below:

Step 1: Open the driver installation folder, for example **C:\ICPDAS\VXC-1x8 (or PCIe-S1x8)**, and then double click the **unins000.exe** uninstaller application.



Step 2: The uninstaller application will then ask you to confirm that you want wish to remove the utility program. Click the **“Yes”** button to continue.

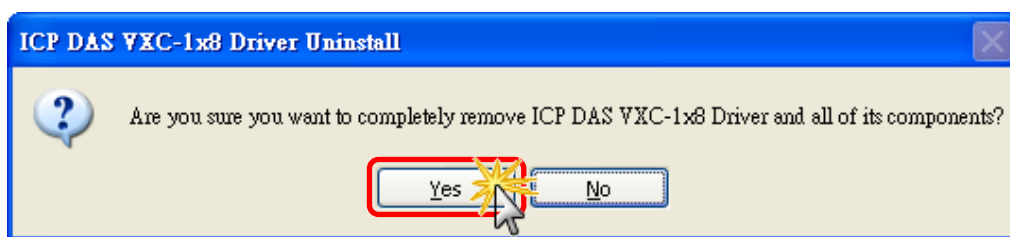

Step 3: The **“Remove Shared File?”** dialog box will be displayed asking whether you wish to remove the shared file. Click the **“Yes to All”** button to continue.

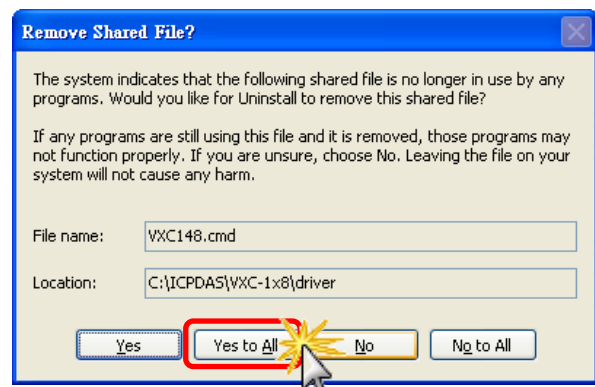

Step 4: After the uninstallation process is complete, a dialog box will be displayed to notify that the driver was successfully removed. Click the **“OK”** button to finish the uninstallation process.

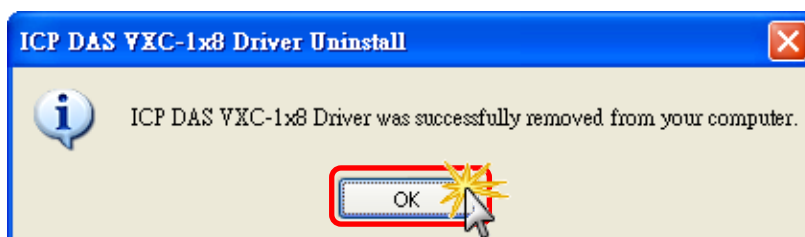

5. Testing the Multiport Series Card

This chapter provides detailed information regarding the “self-test” process, which enables the user to confirm whether or not the VXC-1x8U/PCIe-S1x8 series card is operating correctly. Before performing the “self-test”, the hardware and driver installation must be completed. For detailed information regarding hardware and driver installation, refer to [Chapter 3 Hardware Installation](#) and [Chapter 4 Software Installation](#).

Preparing the device

Before beginning the “self-test”, ensure that the following items are available:

- A DN-09-2 (optional) terminal board
- A CA-9-6210 (optional) cable
- A CA-0910F (optional) cable



5.1 Self-test Wiring

Step 1: Connect the DN-09-2 terminal board to the VXC-1x8U/PCIe-S1x8 series card using the CA-9-6210 and CA-0910F cables.

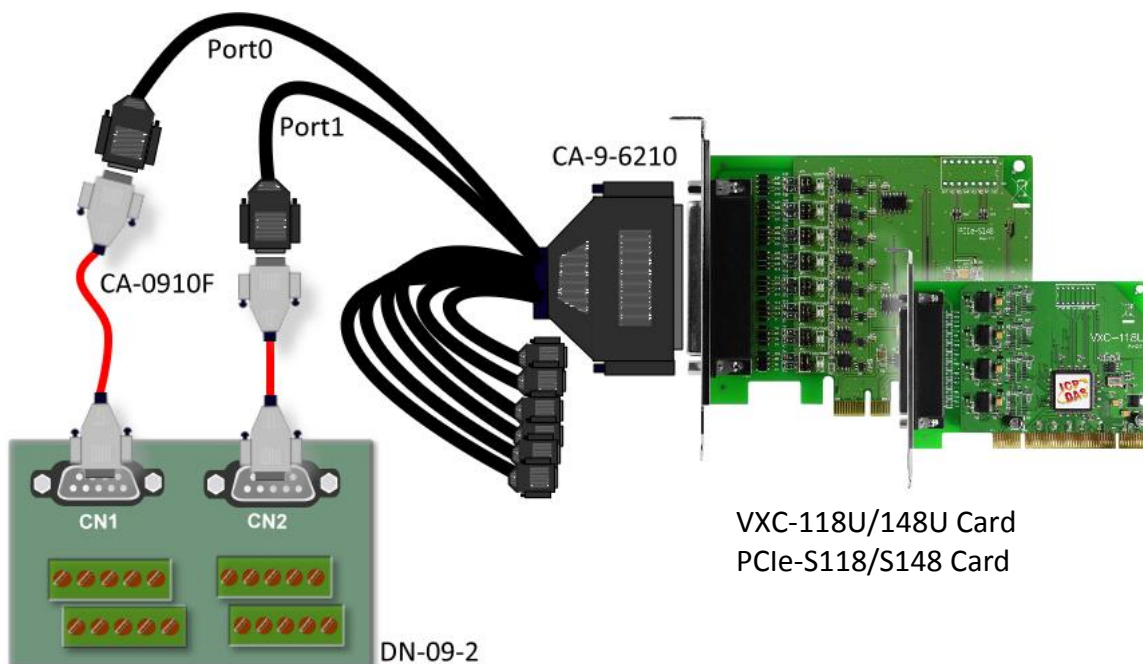

■ VXC-118U/PCIe-S118 Card (RS-232 Wiring):

Pin Assignment	Pin No.		Pin No.	Pin Assignment
TxD0	3	↔	2	RxD1
RxD0	2	↔	3	TxD1
GND	5	↔	5	GND

Step 2: Perform the “self-test” by shorting the RxD, TxD and GND pins of both Port0 and Port1.

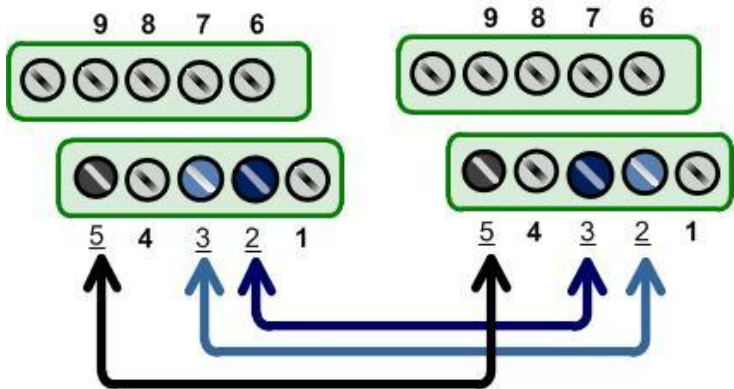

■ VXC-148U/PCIe-S148 Card (RS-485 Wiring):

Pin Assignment	Pin No.		Pin No.	Pin Assignment
Data0-	1	↔	1	Data1-
Data0+	2	↔	2	Data1+
GND	5	↔	5	GND

Step 2: Perform the “self-test” by shorting the Port0 Data+ and Port1 Data+, the Port0 Data- and Port1 Data- pins and the Port0 GND and Port1 GND pins.

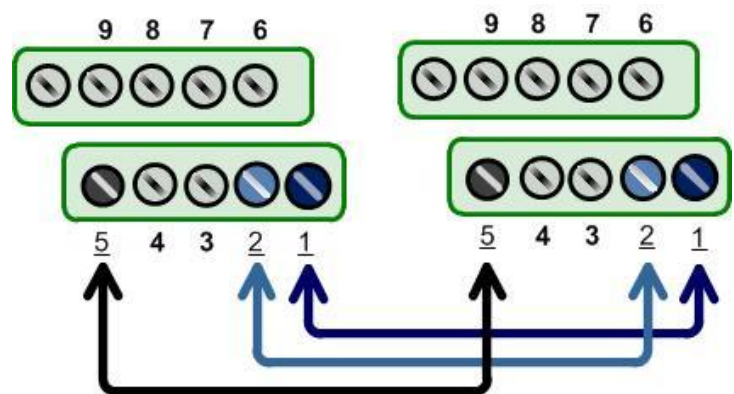

⚠ Note: For detailed information regarding wiring and pin assignments for the RS-232/422/485, refer to [Section 2.2 Wiring Notes for RS-232/422/485](#) and [Section 2.3 Pin Assignments](#).

5.2 Execute the Test Program

Step 1: Execute the “Test2COM.exe” application, which can be found on the companion CD at:

CD\Napdos\multiport\utility

Or download it from:

<http://ftp.icpdas.com/pub/cd/iocard/pci/napdos/multiport/utility/>



Step 2: Set the appropriate COM Ports, Baud Rate and Data Format information to the values shown in the image below.

- 1: COM Ports: Enter COM3(First), COM4(Second).
- 2: Data Bits: Check “8”
- 3: Parity: Check “None”
- 4: Stop Bits: Check “1”
- 5: Baud Rates: Check values 9600 to 115200
- 6: Loop: Type “1”
- 7: Click the “Start Test” button to begin the test.

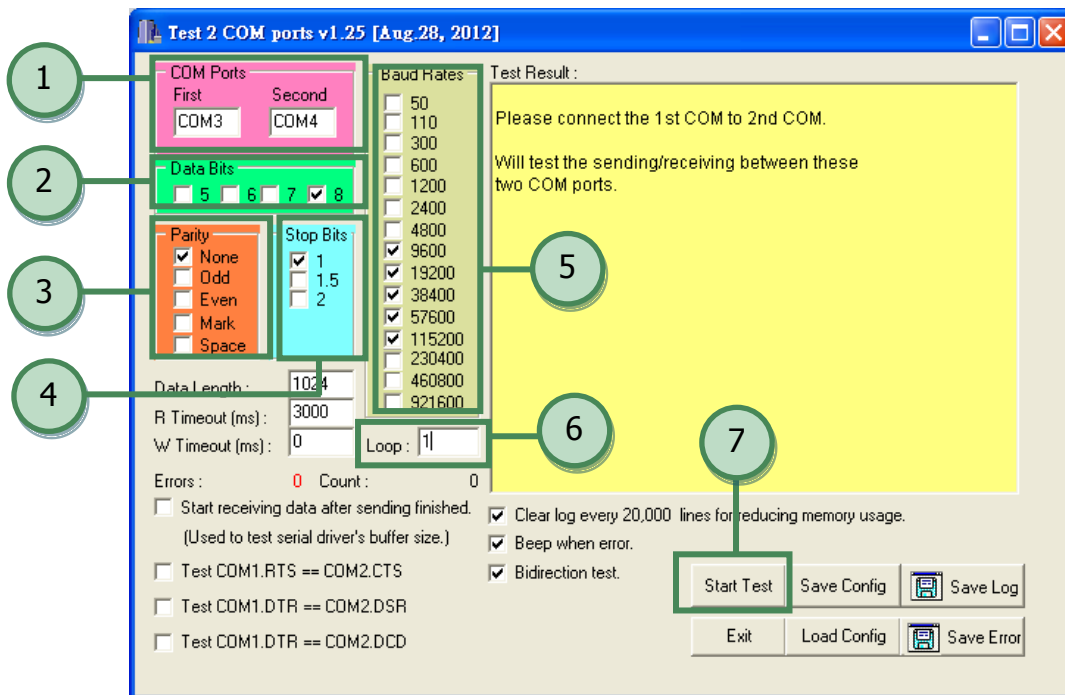



Notes:

1. Depending on the operating system, COM port mapping may be applied automatically. You should first confirm the number of the COM Port for VXC-1x8U/PCIe-S1x8 series card through Device Manager (see [Section 4.5 Verifying the Installation](#)) and then test this COM Port using the Test2COM.exe application.
2. The Baud Rate and Data Format settings used in the Test2COM application depend on the COM ports being used by the VXC-1x8U/PCIe-S1x8 series card. Refer to [Section 1.2 Specifications](#) for more detailed information.

Step 3: Refer to the test results. If the test was successful, the message “Failed Test: 0” will be displayed.

The “self-test” process is now complete and your COM port program can now be operated using this extended COM Port.

