

---

# ELIT-1270

4K Multiple Display Controller with AMD  
Ryzen™ Embedded V series APU

## User's Manual

Version 1.1

---

## Revision History

Version	Date	Description
1.0	2020.05	Initial release
1.1	2022.03	Add Accessory Item description in P.4

<b>Revision History .....</b>	<b>ii</b>
<b>Contents .....</b>	<b>i</b>
<b>Preface.....</b>	<b>iii</b>
Copyright Notice .....	iii
Declaration of Conformity .....	iii
CE.....	iii
FCC Class A .....	iii
RoHS .....	iv
SVHC / REACH .....	iv
Important Safety Instructions .....	v
Warning.....	vi
Lithium Battery Replacement.....	vi
Technical Support .....	vi
Warranty.....	vii
<b>Chapter 1 - Introduction.....</b>	<b>1</b>
1.1. Features.....	2
1.2. About this Manual .....	2
1.3. Specifications.....	3
1.4. Inside the Package .....	4
1.5. Ordering Information .....	5
<b>Chapter 2 - Getting Started.....</b>	<b>7</b>
2.1. Dimensions .....	8
2.2. Tour the Computer .....	9
2.3. Driver Installation Note.....	10
<b>Chapter 3 - Engine of the Computer.....</b>	<b>11</b>
3.1. Board Layout.....	12
3.2. Jumpers and Connectors.....	15
3.2.1. Jumpers .....	15
3.2.2. Connectors .....	18
<b>Chapter 4 - Installation and Maintenance.....</b>	<b>31</b>
4.1. Access the Inside of the Computer .....	32
4.1.1. Disassemble the Computer .....	32
4.1.2. Reassemble the Computer .....	34
4.2. Install Hardware .....	35
4.2.1. Install SIM Module .....	35
4.2.2. Install Wi-Fi Module .....	36
4.2.3. Install Memory Module.....	40
4.2.4. Install M.2 SSD .....	42
4.3. Wall Mounting (optional) .....	43

<b>Chapter 5 - BIOS</b> .....	<b>45</b>
5.1. Main .....	48
5.2. Advanced .....	49
5.2.1. AMD CBS .....	50
5.2.2. CPU Configuration .....	51
5.2.3. ACPI Settings .....	52
5.2.4. Trusted Computing .....	53
5.2.5. USB Configuration .....	54
5.2.6. NVME Configuration .....	55
5.2.7. Network Stack Configuration .....	56
5.2.8. IDE Configuration .....	57
5.2.9. Super IO Configuration .....	58
5.2.10. Hardware Monitor .....	59
5.2.11. S5 RTC Wake Settings .....	60
5.2.12. CSM Configuration .....	61
5.3. Chipset .....	62
5.3.1. SB USB Configuration .....	63
5.4. Security .....	64
5.4.1. Secure Boot .....	65
5.4.2. Factory Key Provision .....	66
5.5. Boot .....	67
5.6. Save & Exit .....	69



## Copyright Notice

All Rights Reserved.

The information in this document is subject to change without prior notice in order to improve the reliability, design and function. It does not represent a commitment on the part of the manufacturer.

Under no circumstances will the manufacturer be liable for any direct, indirect, special, incidental, or consequential damages arising from the use or inability to use the product or documentation, even if advised of the possibility of such damages.

This document contains proprietary information protected by copyright. All rights are reserved. No part of this document may be reproduced by any mechanical, electronic, or other means in any form without prior written permission of the manufacturer.

## Declaration of Conformity

### CE

The CE symbol on your product indicates that it is in compliance with the directives of the Union European (EU). A Certificate of Compliance is available by contacting Technical Support.

This product has passed the CE test for environmental specifications when shielded cables are used for external wiring. We recommend the use of shielded cables. This kind of cable is available from ARBOR. Please contact your local supplier for ordering information.

### Warning

This is a class A product. In a domestic environment this product may cause radio interference in which case the user may be required to take adequate measures.

### FCC Class A

This device complies with Part 15 of the FCC Rules. Operation is subject to the following two conditions:

- (1) This device may not cause harmful interference, and
- (2) This device must accept any interference received, including interference that may cause undesired operation.

### NOTE:

This equipment has been tested and found to comply with the limits for a Class A digital device, pursuant to Part 15 of the FCC Rules. These limits are designed to provide reasonable protection against harmful interference when the equipment is operated in a commercial environment. This equipment generates, uses, and can radiate radio frequency energy and, if not installed and used in accordance with the instruction manual, may cause harmful interference to radio communications. Operation of this equipment in a residential area is likely to cause harmful interference in which case the user will be required to correct the interference at his own expense.

### RoHS

ARBOR Technology Corp. certifies that all components in its products are in compliance and conform to the European Union's Restriction of Use of Hazardous Substances in Electrical and Electronic Equipment (RoHS) Directive 2002/95/EC.

The above mentioned directive was published on 2/13/2003. The main purpose of the directive is to prohibit the use of lead, mercury, cadmium, hexavalent chromium, polybrominated biphenyls (PBB), and polybrominated diphenyl ethers (PBDE) in electrical and electronic products. Member states of the EU are to enforce by 7/1/2006.

ARBOR Technology Corp. hereby states that the listed products do not contain unintentional additions of lead, mercury, hex chrome, PBB or PBDB that exceed a maximum concentration value of 0.1% by weight or for cadmium exceed 0.01% by weight, per homogenous material. Homogenous material is defined as a substance or mixture of substances with uniform composition (such as solders, resins, plating, etc.). Lead-free solder is used for all terminations (Sn(96-96.5%), Ag(3.0-3.5%) and Cu(0.5%)).

### SVHC / REACH

To minimize the environmental impact and take more responsibility to the earth we live, Arbor hereby confirms all products comply with the restriction of SVHC (Substances of Very High Concern) in (EC) 1907/2006 (REACH --Registration, Evaluation, Authorization, and Restriction of Chemicals) regulated by the European Union.

All substances listed in SVHC < 0.1 % by weight (1000 ppm)

## Important Safety Instructions

Read these safety instructions carefully

1. Read all cautions and warnings on the equipment.
2. Place this equipment on a reliable surface when installing. Dropping it or letting it fall may cause damage
3. Make sure the correct voltage is connected to the equipment.
4. For pluggable equipment, the socket outlet should be near the equipment and should be easily accessible.
5. Keep this equipment away from humidity.
6. The openings on the enclosure are for air convection and protect the equipment from overheating. **DO NOT COVER THE OPENINGS.**
7. Position the power cord so that people cannot step on it. Do not place anything over the power cord.
8. Never pour any liquid into opening. This may cause fire or electrical shock.
9. Never open the equipment. For safety reasons, the equipment should be opened only by qualified service personnel.
10. If one of the following situations arises, get the equipment checked by service personnel:
  - a. The power cord or plug is damaged.
  - b. Liquid has penetrated into the equipment.
  - c. The equipment has been exposed to moisture.
  - d. The equipment does not work well, or you cannot get it to work according to the user's manual.
  - e. The equipment has been dropped or damaged.
  - f. The equipment has obvious signs of breakage.
11. Keep this User's Manual for later reference.

## **Warning**

The Box PC and its components contain very delicately Integrated Circuits (IC). To protect the Box PC and its components against damage caused by static electricity, you should always follow the precautions below when handling it:

1. Disconnect your Box PC from the power source when you want to work on the inside.
2. Use a grounded wrist strap when handling computer components.
3. Place components on a grounded antistatic pad or on the bag that came with the Box PC, whenever components are separated from the system.

## **Lithium Battery Replacement**

Incorrect replacement of the lithium battery may lead to a risk of explosion.

The lithium battery must be replaced with an identical battery or a battery type recommended by the manufacturer.

Do not throw lithium batteries into the trash can. It must be disposed of in accordance with local regulations concerning special waste.

## **Technical Support**

If you have any technical difficulties, please consult the user's manual first at:  
<http://www.arbor.com.tw>

Please do not hesitate to call or e-mail our customer service when you still cannot find out the answer.

<http://www.arbor-technology.com>

E-mail: [info@arbor.com.tw](mailto:info@arbor.com.tw)

## **Warranty**

This product is warranted to be in good working order for a period of one year from the date of purchase. Should this product fail to be in good working order at any time during this period, we will, at our option, replace or repair it at no additional charge except as set forth in the following terms. This warranty does not apply to products damaged by misuse, modifications, accident or disaster.

Vendor assumes no liability for any damages, lost profits, lost savings or any other incidental or consequential damage resulting from the use, misuse of, or inability to use this product. Vendor will not be liable for any claim made by any other related party.

Vendors disclaim all other warranties, either expressed or implied, including but not limited to implied warranties of merchantability and fitness for a particular purpose, with respect to the hardware, the accompanying product's manual(s) and written materials, and any accompanying hardware. This limited warranty gives you specific legal rights.

Return authorization must be obtained from the vendor before returned merchandise will be accepted. Authorization can be obtained by calling or faxing the vendor and requesting a Return Merchandise Authorization (RMA) number. Returned goods should always be accompanied by a clear problem description.

---

This page is intentionally left blank.

---

# Chapter 1

## Introduction

### 1.1. Features

- AMD Ryzen™ Embedded V1000 series APU
- 2 x DDR4 SO-DIMM socket, dual channel, up to 2666 MHz
- Support 4 x DisplayPort 1.2, up to 4K (UHD) resolution
- Support 2 x USB 3.1 Gen1 and 2 x USB 2.0
- 1 x M.2 2242/ 2280 M-Key for storage
- 1 x mPCIe slot for connectivity expansion



ELIT-1270-1605 (fan-less)



ELIT-1270-1807F

### 1.2. About this Manual

This manual is meant for the experienced users and integrators with hardware knowledge of personal computers. If you are not sure about the description in this manual, consult your vendor before further handling.

We recommend that you keep one copy of this manual for the quick reference for any necessary maintenance in the future. Thank you for choosing ARBOR products.



### 1.3. Specifications

<b>System</b>	
CPU	AMD Ryzen™ Embedded V1000 series (SOC FP5) APU up to 54W TDP
Memory	2 x 260-pin DDR4 SO-DIMM socket. - Support 2400MHz SDRAM up to 32GB (V1605B) - Support 2666MHz SDRAM up to 32GB (V1807B)
Chipset	AMD integrated SOC
Graphics	AMD Radeon™ Vega X Graphics
Watchdog Timer	1~255 levels reset
<b>I/O</b>	
USB Port	2 x USB 2.0
	2 x USB 3.1 Gen1
LAN	2 x RJ-45 port for Giga LAN
Serial Port	2 x RS 232/422/485 w/ DB9 connector
Video Port	4 x DisplayPort 1.2
Audio Port	1 x Line-out and 1 x Mic-in
Expansion Bus	1 x M.2 2242/ 2280 M-Key slot (PCIe x4 + SATA III)
	1 x mPCIe slot (PCIe x1 + USB 2.0)
<b>Environmental</b>	
Operating Temp.	-10 ~ 50°C, ambient w/ air flow
Storage Temp.	-20 ~ 60°C
Operating Humidity	10-95% @ 50°C (non-condensing)
Vibration	5~500Hz 3 Grms X,Y, Z axis w/storage
Shock & Crash	10G peak acceleration (11 m sec. duration), operation
	30G peak acceleration (11 m sec. duration), nonoperation
<b>Qualification</b>	
Certification	CE/ FCC Class A

Power Requirement	
Power Input	DC 9~36V (4-pin terminal block)
Power Consumption	ELIT-1270-1605 : 40W ELIT-1270-1807F : 65W
Storage	
Type	1 x M.2 2242/ 2280 M-Key slot
Mechanical	
Construction	Aluminum alloy and sheet metal
Mounting	VESA-mount and Wall-mount
Weight (approx.)	2.98 kg (ELIT-1270-1605) 2.00 kg (ELIT-1270-1807F)
Dimensions (W x H x D)	240 x 50 x 204 mm (ELIT-1270-1605) 240 x 41 x 204 mm (ELIT-1270-1807F)
OS Support	
Windows®10 IoT 64-bit / Linux: Ubuntu (Kernel: 3.1X)	

### 1.4. Inside the Package

Upon opening the package, carefully inspect the contents. If any of the items is missing or appears damaged, contact your local dealer or distributor. The package should contain the following items:



ELIT-1270-1605 (fan-less)



ELIT-1270-1807F

1 x ELIT-1270



1 x **Accessory Box** that contains the following items:

- User's manual
- Screws
- 4-pin plug for terminal block
- Wall mount bracket

## 1.5. Ordering Information

<b>ELIT-1270-1605</b>	ELIT-1270 w/ AMD Ryzen V1605B, 4 x DP, 2 x GbE LAN, 4 x USB, 2 x COM w/o Fan
<b>ELIT-1270-1807F</b>	ELIT-1270 w/ AMD Ryzen V1807B, 4 x DP, 2 x GbE LAN, 4 x USB, 2 x COM w/ Fan

---

This page is intentionally left blank.

---

# Chapter 2

## Getting Started

## 2.1. Dimensions

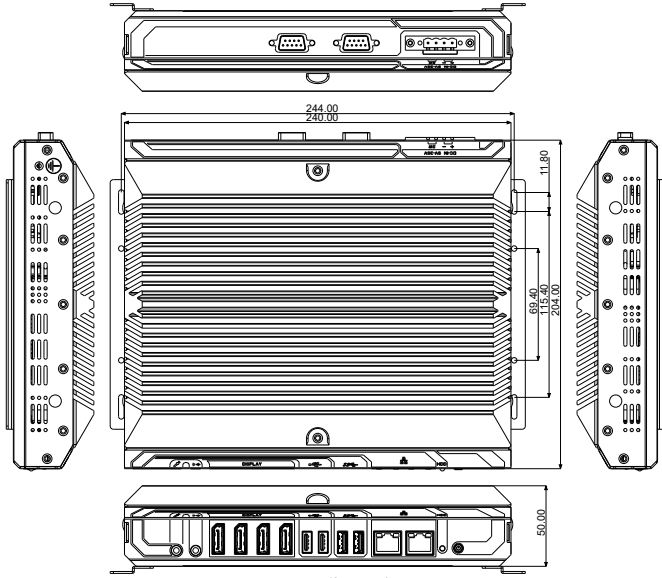

ELIT-1270-1605 (fan-less)

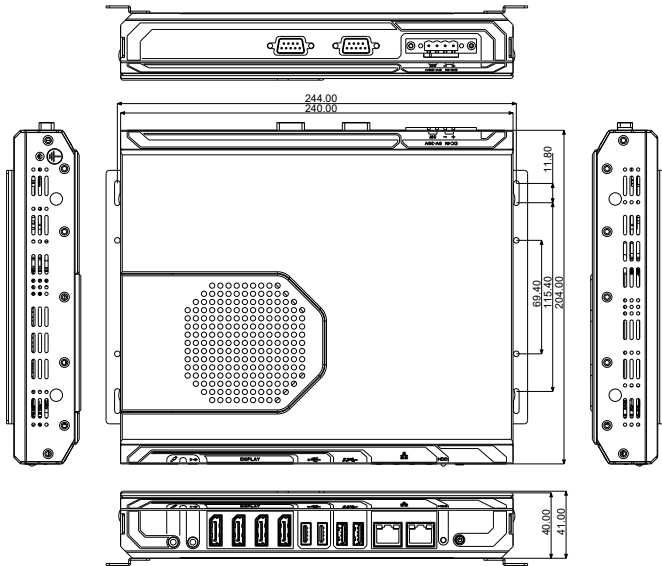

ELIT-1270-1807F

Unit: mm

## 2.2. Tour the Computer

The front and rear panels of the ELIT-1270-1807F and ELIT-1270-1605 are similar. The following will use ELIT-1270-1807F as the example.

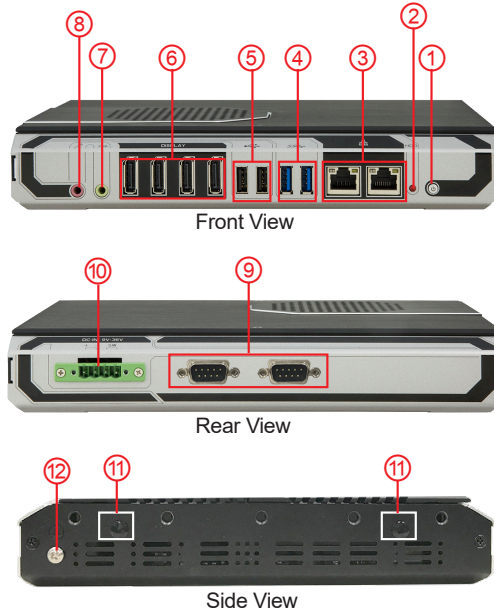

No.	Description
①	Power button
②	HDD LED indicator
③	2 x RJ-45 GbE ports
④	2 x Type-A USB 3.1 Gen1 ports
⑤	2 x Type-A USB 2.0 ports
⑥	4 x DisplayPort 1.2
⑦	Line-out
⑧	Mic-in

⑨	2 x RS-232/422/485 serial ports
⑩	DC 9~36V Input (4-PIN Terminal Block)
⑪	Antenna holes
⑫	Ground screw

### 2.3. Driver Installation Note

For operating system of Windows 10, please go to our website at [www.arbor-technology.com](http://www.arbor-technology.com) and download the driver pack from the product page. Then unzip the downloaded file and follow the sequence below to install the drivers to prevent errors:

Chipset → Graphics → Audio → Ethernet → ME



---

# Chapter 3

## Engine of the Computer

### 3.1. Board Layout

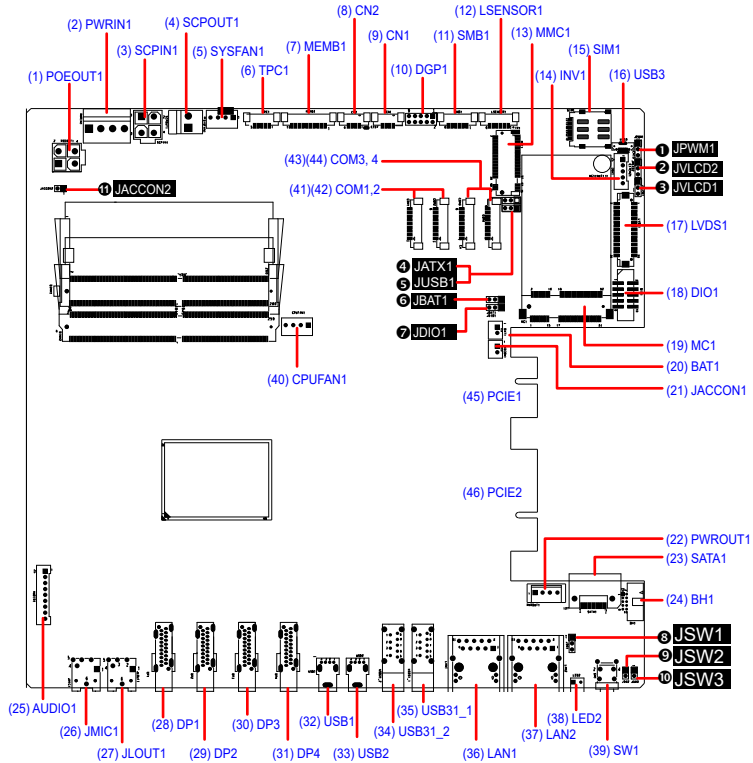

#### Jumpers

No	Label	Description
1	JPWM1 (Reserved)	LVDS Brightness Control
2	JVLCD2 (Reserved)	LVDS Backlight Output Voltage
3	JVLCD1 (Reserved)	LVDS VCC Output Voltage
4	JATX1 (Reserved)	AT Mode Selection
5	JUSB1	MCU USB Mode Selection
6	JBAT1	Clear CMOS Selection

7	JDIO1 (Reserved)	Digital I/O VCC Output Voltage
8	JSW1 (Reserved)	DisplayPort 4 or LVDS Signal Output Selection
9	JSW2 (Reserved)	Reset Button
10	JSW3 (Reserved)	Power Button
11	JACCON2 (Reserved)	ACC ON Mode selection (for debug)

## Connectors

No.	Label	Description
1	POEOUT1 (Reserved)	PoE Power Connector
2	PWRIN1	Power Input Connector
3	SCPIN1 (Reserved)	CAP Output Connector
4	SCPOUT1 (Reserved)	CAP Input Connector
5	SYSFAN1	System Fan Power Connector
6	TPC1 (Reserved)	Resistive Touch Connector
7	MEMB1 (Reserved)	Membrane Connector
8, 9	CN2, 1 (Reserved)	USB Connector
10	DGP1 (Reserved)	External 80 Port Pin Header
11	SMB1 (Reserved)	SMbus Connector
12	LSENSOR1 (Reserved)	Light Sensor Connector
13	MMC1	M.2 M-Key Connector
14	INV1 (Reserved)	Backlight Connector
15	SIM1	SIM Card Socket
16	USB3 (Reserved)	MCU USB Connector
17	LVDS1 (Reserved)	LVDS connector
18	DIO1 (Reserved)	Digital IO Connector
19	MC1	PCI Express Mini-card Full Size socket
20	BAT1	RTC Battery Connector
21	JACCON1 (Reserved)	Ignition Power Connector
22	PWROUT1, 2 (Reserved)	SATA Power Connector
23	SATA1 (Reserved)	SATA Connector
24	BH1	SWD Debug Connector
25	AUDIO1 (Reserved)	HAD Audio Board Connector
26	JMIC1	Mic-in Port

## Engine of the Computer

---

27	JLOUT1	Line-out Port
28~31	DP1~4	DisplayPort 1.2 Connector
32, 33	USB1, 2	USB 3.0/2.0 Connector
34, 35	USB31_2, USB32_1	USB 3.1 Gen1 Connector
36, 37	LAN1, 2	RJ-45 GbE Connector
38	LED2	HDD LED Output
39	SW1	Power Button
40	CPUFAN1	CPU Fan Power Connector
41, 42	COM1, 2	RS-232/422/485 Selectable Serial Port
43, 44	COM3, 4 (Reserved)	RS-232 Serial Port
45	PCIE1 (Reserved)	PCIe x1 Golden Finger
46	PCIE2 (Reserved)	PCIe x4 Golden Finger



## 3.2. Jumpers and Connectors

### 3.2.1. Jumpers

#### ①JPWM1 (Reserved)

**Function:** LVDS Brightness Control



**Jumper Type:** 2.00mm pitch, 1x3-pin header

Setting:	Pin	Description	
	1-2	Control by SOC (default)	
	2-3	Control by PIC	

#### ②JVLCD2 (Reserved)

**Function:** LVDS Backlight Output Voltage



**Jumper Type:** 2.00mm pitch, 1x3-pin header

Setting:	Pin	Description	
	1-2	12V	
	2-3	+5V (default)	

#### ③JVLCD1 (Reserved)

**Function:** LVDS VCC Output Voltage



**Jumper Type:** 2.00mm pitch, 1x3-pin header

Setting:	Pin	Description	
	1-2	+3V (default)	
	2-3	+5V	

#### ④ JATX1 (Reserved)

**Function:** AT Mode selection



**Jumper Type:** 2.00mm pitch, 1x3-pin header

Setting:	Pin	Description	
	1-2	AT Mode (default)	
	2-3	ATX Mode	

#### ⑤ JUSB1

**Function:** MCU USB Mode Selection



**Jumper Type:** 2.00mm pitch, 1x3-pin header

Setting:	Pin	Description	
	1-2	MCU USB to SOC (default)	
	2-3	MCU USB to debug USB port	

#### ⑥ JBAT1

**Function:** Clear CMOS Selection



**Jumper Type:** 2.00mm pitch, 1x3-pin header

Setting:	Pin	Description	
	1-2	Keep CMOS (default)	
	2-3	Clear CMOS	

#### ⑦ JDIO1 (Reserved)

**Function:** Digital I/O VCC Output Voltage



**Jumper Type:** 2.00mm pitch, 1x3-pin header

Setting:	Pin	Description	
	1-2	12V	
	2-3	5V (default)	

### ⑧JSW1 (Reserved)

**Function:** DisplayPort 4 or LVDS Sigital Output Selection

**Jumper Type:** 2.00mm pitch, 1x3-pin header

Setting:	Pin	Description	
	1-2	DP Mode (default)	
	2-3	LVDS Mode	

### ⑨JSW2 (Reserved)

**Function:** Reset Button

**Jumper Type:** 2.00mm pitch, 1x3-pin header

### ⑩JSW3 (Reserved)



**Function:** Power Button

**Jumper Type:** 2.00mm pitch, 1x3-pin header

### ⑪JACCON2 (Reserved)

**Function:** ACC On Mode Selection (for debug)

**Jumper Type:** 2.00mm pitch, 1x2-pin header

Setting:	Pin	Description	
	Short	ACC ON mode (default)	
	Open	Car mode	

### 3.2.2. Connectors

#### (1) POEOUT1 (Reserved)

**Function:** PoE Power Connector  
**Connector Type:** 2.54mm-pitch 4-pin header  
**Pin Assignment:**

Pin	Desc.
1	GND
2	GND
3	DCIN
4	DCIN

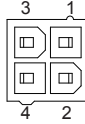

#### (2) PWRIN1

**Function:** Power Input Connector  
**Connector Type:** 3.96 mm pitch 1x4-pin one-wall wafer connector  
**Pin Assignment:**

Pin	Desc.
1	DCIN
2	GDN
3	GDN
4	PWR_IN_SW#



DC IN 9~36V Power Connector

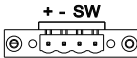
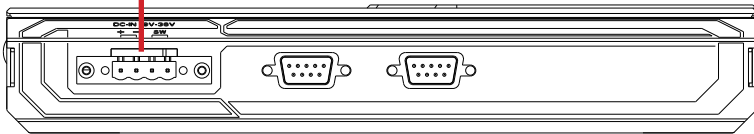

#### (3) SCPIN1 (Reserved)

**Function:** CAP Output Connector  
**Connector Type:** 2.54mm-pitch 4-pin header  
**Pin Assignment:**

Pin	Desc.
1	GND
2	GND
3	+V12VA_PIC
4	+V12VA_PIC

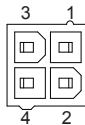



#### (4) SCPOUT1 (Reserved)

**Function:** CAP Input Connector  
**Connector Type:** 3.96mm-pitch 1x2-pin one-wall wafer connector  
**Pin Assignment:**

Pin	Desc.
1	+V12VA_S
2	GND



#### (5) SYSFAN1

**Function:** System Fan Power Connector (for ELIT-1270-1807F)  
**Connector Type:** 2.54mm pitch 1x4 one-wall wafer connector  
**Pin Assignment:**

Pin	Desc.
1	GND
2	+12V
3	RPM
4	CTRL



#### (6) TPC1 (Reserved)

**Function:** Resistive Touch Connector  
**Connector Type:** 1.25mm pitch 1x5-pin wafer connector  
**Pin Assignment:**

Pin	Desc.
1	Y+
2	X+
3	SENSE
4	Y-
5	X-

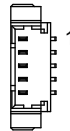

**(7) MEMB1 (Reserved)**

**Function:** Membrane Connector  
**Connector Type:** 1.25mm pitch 1x10-pin wafer connector  
**Pin Assignment:**

Pin	Description.
1	+V5
2	PWR_IN_SW#
3	EN_PANEL#
4	PANEL_PWM+
5	PANEL_PWM-
6	GPIO_FTN
7	MEMB1_LED_ON#
8	MEMB1_LED_OFF#
9	GND
10	NC



**(8)(9) CN2, 1 (Reserved)**

**Function:** USB Connector  
**Connector Type:** 1.25mm pitch 1x4-pin wafer connector  
**Pin Assignment:**

Pin	Description.
1	+5V
2	D-
3	D+
4	GND

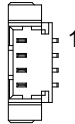

**(10) DGP1 (Reserved)**

**Function:** External 80 Port Pin Header  
**Connector Type:** 2.00mm-pitch 2x5-pin header  
**Pin Assignment:**

Pin	Description	Pin	Description
1	PCICLK_24MHz	2	GND
3	FRAME#	4	LAD0
5	PLTRST#	6	NC
7	LAD3	8	LAD2
9	VCC3	10	LAD1

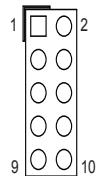

### (11) SMB1 (Reserved)

**Function:** SMBus Connector  
**Connector Type:** 1.25mm pitch 1x6-pin wafer connector  
**Pin Assignment:**

Pin	Description.
1	+V3.3
2	GND
3	SCLK0
4	GND
5	SDATA0
6	+V12



### (12) LSENSOR1 (Reserved)

**Function:** Light Sensor Connector  
**Connector Type:** 1.25mm pitch 1x6-pin wafer connector  
**Pin Assignment:**

Pin	Description.
1	+V3.3
2	GND
3	ADDR_SEL
4	SMBCK_LSENSOR
5	SMBDA_LSENSOR
6	LSENSOR_INT

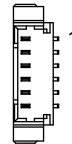

### (13) MMC1

**Function:** M.2 M-Key Connector  
**Connector Type:** M.2 75-pin M-Key connector for PCIe x4/SATA-III SSD storage, supporting 22x42 / 22x80 modules  
**Pin Assignment:** The pin assignments conform to the industry standard.



**(14) INV1 (Reserved)**

**Function:** Backlight Connector  
**Connector Type:** 2.00mm pitch 1x5-pin wafer connector  
**Pin Assignment:**

Pin	Desc.
1	VDD(5V/12V)
2	GND
3	Backlight_EN
4	Brightness(PWM)
5	GND



**(15) SIM1**

**Function:** SIM Card Socket  
**Connector Type:** SIM card socket with a hinged cover  
**Pin Assignment:**

Pin	Description	Pin	Description
C1	Power Voltage	C5	GND
C2	Reset Signal	C6	NC
C3	Clock Signal	C7	I/O

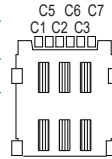

**(16) USB3 (Reserved)**

**Function:** MCU USB Connector  
**Connector Type:** USB 2.0 micro B Connector  
**Pin Assignment:** The pin assignments conform to the industry standard.

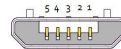

**(17) LVDS1 (Reserved)**

**Function:** LVDS Connector  
**Connector Type:** 1.25mm pitch 2x15-pin BTB connector  
**Pin Assignment:**

Pin	Description	Pin	Description
1	VCC(5V/3V)	2	VCC(5V/3V)
3	LVDS_A_CLK+	4	LVDS_B_CLK+
5	LVDS_A_CLK-	6	LVDS_B_CLK-
7	GND	8	GND
9	LVDS_A0+	10	LVDS_B0+
11	LVDS_A0-	12	LVDS_B0-
13	GND	14	GND
15	LVDS_A1+	16	LVDS_B1+
17	LVDS_A1-	18	LVDS_B1-
19	GND	20	GND
21	LVDS_A2+	22	LVDS_B2+
23	LVDS_A2-	24	LVDS_B2-
25	GND	26	GND
27	LVDS_A3+	28	LVDS_B3+
29	LVDS_A3-	30	LVDS_B3-



**(18) DIO1 (Reserved)**

**Function:** Digital IO Connector  
**Connector Type:** 2.0mm pitch 2x5-pin box header  
**Pin Assignment:**

Pin	Description	Pin	Description
1	SIO_DIO0	2	SIO_DIO1
3	SIO_DIO2	4	SIO_DIO3
5	SIO_DIO4	6	SIO_DIO5
7	SIO_DIO6	8	SIO_DIO7
9	VCC_DIO (5V/12V)	10	GND

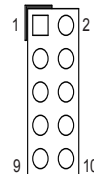

### (19) MC1

**Function:** PCI Express Mini-card Full Size socket  
**Connector Type:** Onboard 0.8mm pitch 52-pin edge card connector  
**Pin Assignment:** The pin assignments conform to the industry standard.

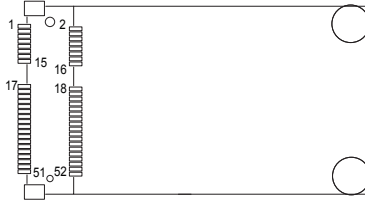

### (20) BAT1

**Function:** RTC Battery Connector  
**Connector Type:** 2.00mm pitch 1x2-pin box connector  
**Setting:**

Pin	Desc.
1	BAT+
2	BAT-



### (21) JACCON1 (Reserved)

**Function:** Ignition Power Connector  
**Connector Type:** 2.00mm pitch 1x2-pin box connector  
**Pin Assignment:**

Pin	Desc.
1	ACC_ON
2	GND



### (22) PWROUT1, 2 (Reserved)

**Destription:** SATA Power.Connector  
**Connector Type:** Onboard 4-pin one-wall wafer connector  
**Pin Assignment:**

Pin	Description
1	+5V
2	GND
3	GND
4	+12V



### (23) SATA1 (Reserved)

**Function:** SATA Connector  
**Connector Type:** On-board Serial ATA Connector  
**Pin Assignment:**

Pin	Desc.
1	GND
2	TX+
3	TX-
4	GND
5	RX-
6	RX+
7	GND

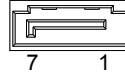

### (24) BH1

**Function:** SWD debug connector  
**Connector Type:** 1.27mm pitch 10-pin connector  
**Pin Assignment:**

Pin	Description	Pin	Description
1	MCU_3V3	2	SWD_DIO
3	GND	4	SWD_CLK
5	GND	6	SWD_SWO
7	N/A	8	N/A
9	N/A	10	IF_RST

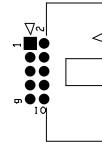

### (25) AUDIO1 (Reserved)

**Function:** HAD Audio board connector  
**Connector Type:** 2.00mm pitch 1x9-pin wafer connector  
**Pin Assignment:**

Pin	Desc.
1	+V12
2	+V3.3
3	HDA_SYNC
4	HDA_SDATA_OUT
5	GND
6	HDA_BIT_CLK
7	GND
8	HDA_RST#
9	HDA_SDATA_IN1

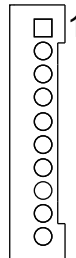

**(26) JM1C1**

**Destription:** Mic-in Port

**Connector Type:** Pink 3.5mm audio jack with shield

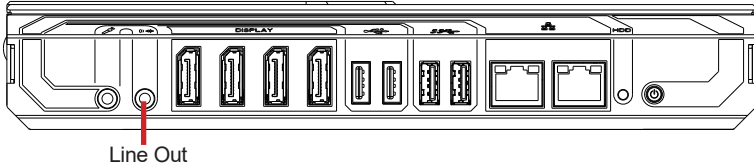

**(27) JLOUT1**

**Destription:** Line-out Port

**Connector Type:** Lime green 3.5mm audio jack with shield

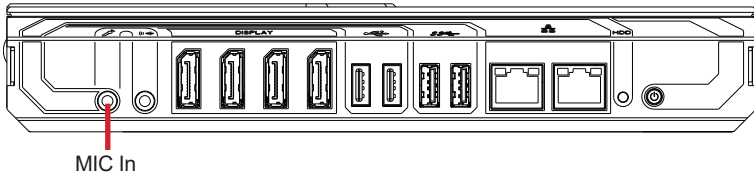

**(28)~(31) DP1~4**

**Function:** DisplayPort 1.2 Connector

**Connector Type:** Connect the display device to the DisplayPort 1.2 Connector

**Pin Assignment:** The pin assignments conform to the industry standard.



**(32)(33) USB1, 2**

**Function:** USB 2.0 Connector

**Connector Type:** USB 2.0 Type-A USB connector

**Pin Assignment:** The pin assignments conform to the industry standard.

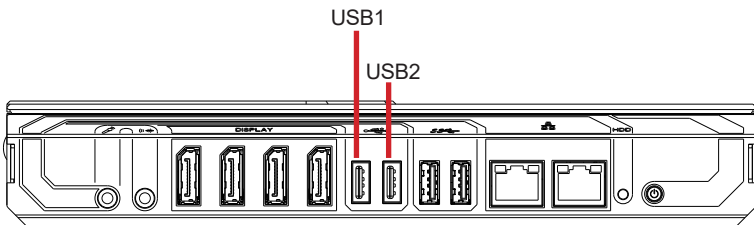



**(34)(35) USB31\_2, 1**

**Function:** USB 3.1 Gen 1 Connector

**Connector Type:** USB 3.1 Gen 1 Type-A USB connector

**Pin Assignment:** The pin assignments conform to the industry standard.

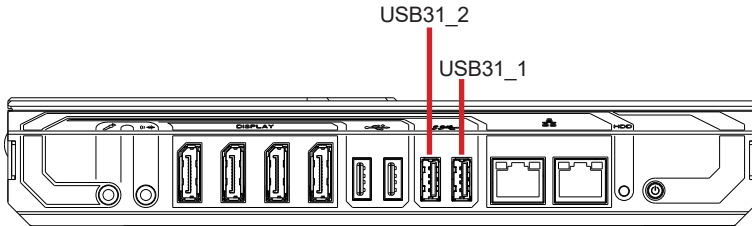

**(36)(37) LAN1, 2**

**Function:** RJ-45 GbE Connector

**Connector Type:** RJ-45 connector that supports 10/100/1000Mbps fast Ethernet

**Pin Assignment:** The pin assignments conform to the industry standard.

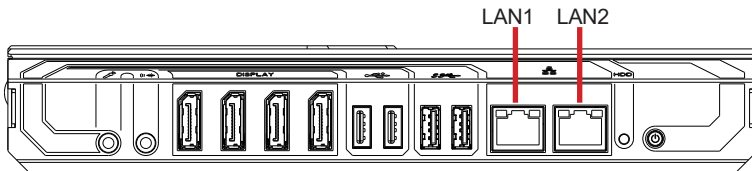
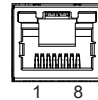

**(38) LED2**

**Function:** HDD LED Output

**(39) SW1**

**Function** Power Button

**Connector Type:** LED tact switch with green and red colors

**Pin Assignment:**

Pin	Description	Pin	Description
1	GND	2	N/A
3	BTN	4	N/A
L1	SW1_LED_N	L2	SW1_LED_P

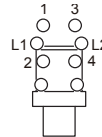

**(40) CPUFAN1**

**Function:** CPU Fan Power Connector (for ELIT-1270-1807F)

**Connector Type:** 2.54 mm pitch 1x4 one-wall wafer connector

**Pin Assignment:**

Pin	Description.
1	GND
2	+12V
3	FAN Speed
4	FAN CTRL

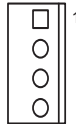

**(41)(42) COM1, 2**

**(43)(44) COM3, 4**

**Function:** COM1, 2: RS-232/422/485 Selectable Serial Port

COM3., 4 RS-232 Serial Port

**Connector Type:** 1.25mm pitch 1x9-pin wafer connector

**Pin Assignment:**

Pin	Desc.
1	XDCD#
2	XDSR#
3	XRXD
4	XRTS#
5	XTXD
6	XCTS#
7	XDTR#
8	XRI#
9	GND



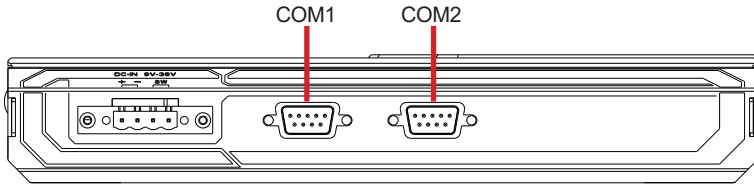

**(45) PCIE1 (Reserved)**

**Function:** PCIe x1 Golden Finger

**Connector Type:** The pin assignments conform to the industry standard.

**(46) PCIE2 (Reserved)**

**Function:** PCIe x4 Golden Finger

**Connector Type:** The pin assignments conform to the industry standard.

---

This page is intentionally left blank.

---

# Chapter 4

## Installation & Maintenance

## 4.1. Access the Inside of the Computer

To use onboard jumpers/connectors or to install/remove internal components, you will need to open the computer to access the inside of the computer. Follow through the guide below to access the inside of the computer.

### 4.1.1. Disassemble the Computer

#### ELIT-1270-1605 (Fanless Model)

1. Remove the 2 screws on the top case as shown below and remove the top case from the computer.



2. Then you can access the inside of the computer. But if you need to install SIM card or Wi-Fi module, proceed to remove the rear panel to access these slots.



3. Remove the 3 screws on the bottom case that securing the rear panel.



4. Remove the screws as shown below on both sides and remove the rear panel.



5. Then you can access the components of the main board.

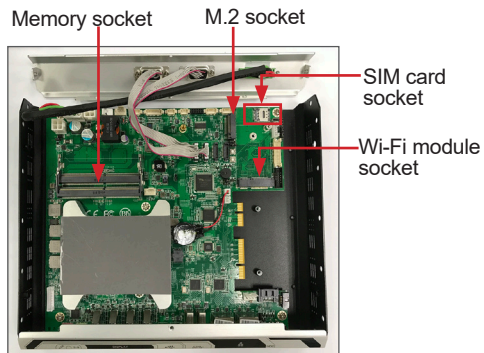

## ELIT-1270-1807F (Model with Fan)

1. Remove the screws on both sides as shown below. Then remove the top case and the rear panel from the computer.

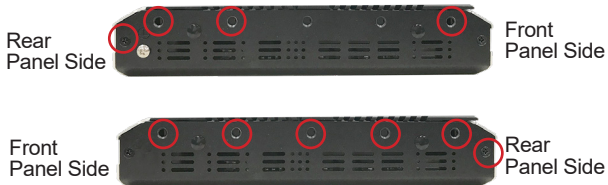

2. Then you can access the components of the main board.

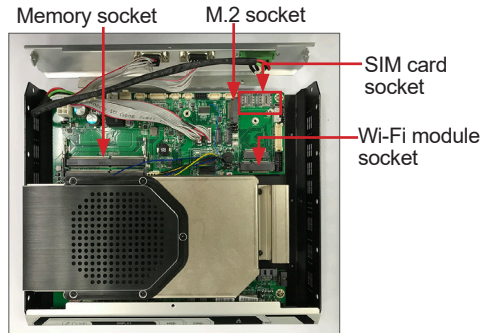

### 4.1.2. Reassemble the Computer

After you make required jumper settings and connections, just follow the steps described in [4.1.1. Disassemble the Computer](#) on page [32](#) in reverse orders to reassemble the computer.



## 4.2. Install Hardware

### 4.2.1. Install SIM Module

1. Locate the SIM card socket.

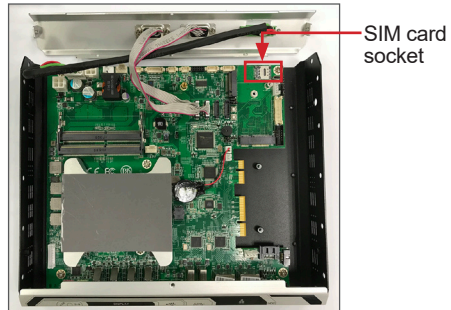

2. Follow the direction of the arrow to open the lid of the SIM card slot.



3. Insert the SIM card into the slot. Close the lid and follow the arrow direction to lock it.



### 4.2.2. Install Wi-Fi Module

The computer comes with one Mini-card socket to load the computer with a wireless module of PCI Express Mini-card form factor. This section will guide you to install the Wi-Fi module.

1. Locate the **PCI Express Mini-card** socket for wireless module.

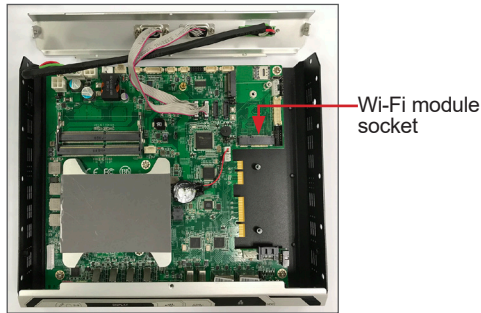

2. Prepare the Wi-Fi module kit. The module is a half-size module of **PCI Express Mini-card** form factor, with two U.FL connectors, one is “MAIN” (marked 0), and the other is “AUX” (marked 1).

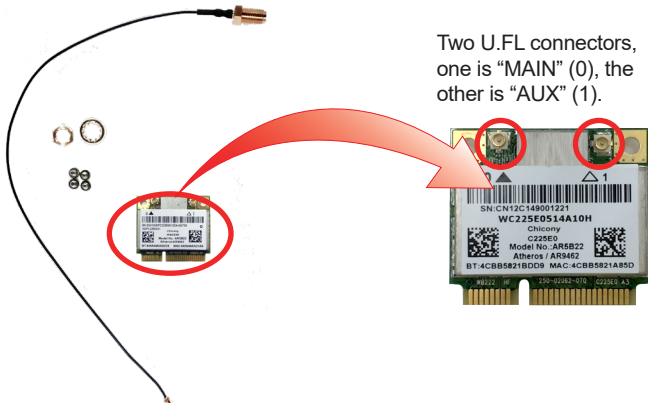

3. Have the RF antenna. The antenna has an SMA connector on one end and an MHF connector on the other.

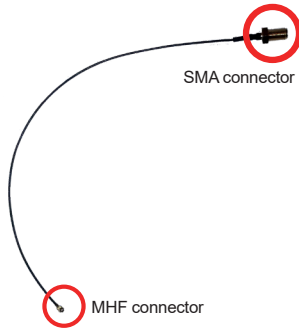

4. Connect the RF antenna's MHF connector to the Wi-Fi module's main connector marked 0. If you are going to connect a secondary antenna, connect it to the connector marked 1.

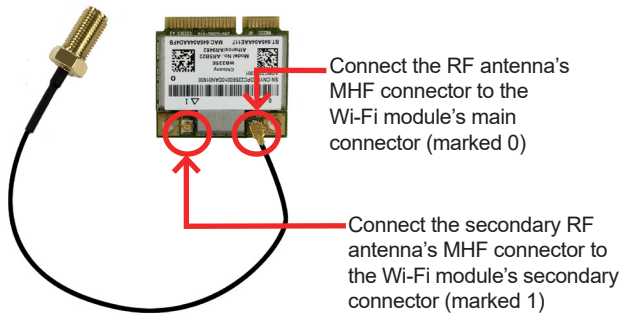

5. Extend the half-size module with a "mini half bracket". Join them together by using two screws as shown below.

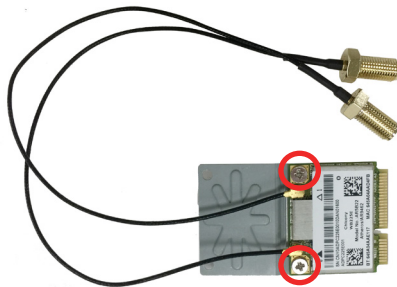

6. Plug the Wi-Fi module to the socket's connector by a slanted angle. Fully

plug the module, and note the notch on the wireless module should meet the break of the connector.

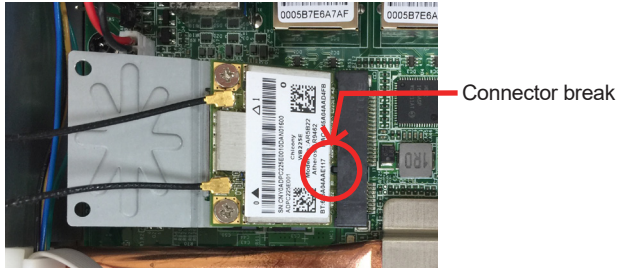

7. Press the module down and fix the module in place using one screw.



8. Remove the plastic plug(s) from the computer's side panel to make antenna hole(s). Keep the plastic plug for any possible restoration in the future.



9. From the other end of the RF antenna, which is an SMA connector, remove the washer and the nut. Save the washer and nut for later use. Note the SMA connector has the form of a threaded bolt, with one flat side.

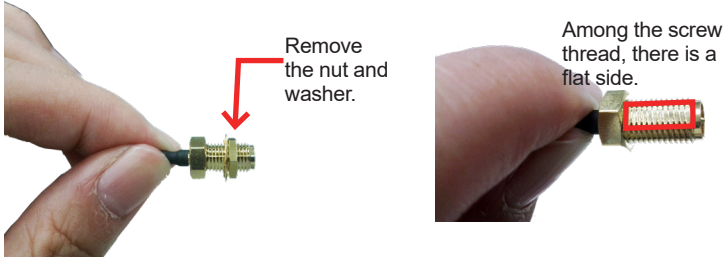

10. Pull the SMA connector through the above mentioned antenna hole. Note to meet the aforesaid flattened side with the antenna hole's flat side.

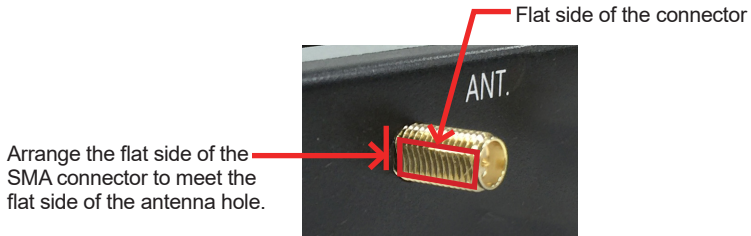

11. Mount the washer first and then the nut to the SMA connector. Make sure the nut is tightened.

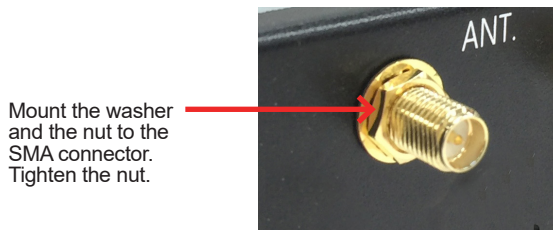

12. Have the external antenna(s). Screw and tightly fasten the antenna(s) to the SMA connector(s).



### 4.2.3. Install Memory Module

The main board has one dual inline memory module (DIMM) socket. Load the computer with a memory module to make the computer run programs. The memory module for the computer's SO-DIMM socket should be a 260-pin DDR4 with a "key notch" off the centre among the pins, which enables the memory module for particular applications. There are another two notches at each left and right side of the memory module to help fix the module in the socket.

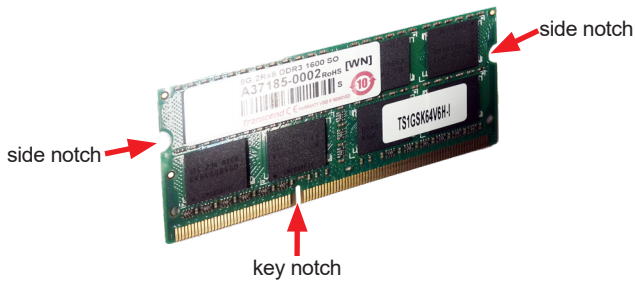

**To install a memory module:**

1. Locate the memory socket of the computer.

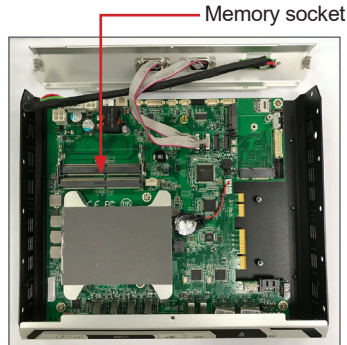

2. Confront the memory module's edge connector with the SO-DIMM slot connector. Align the memory module's key notch at the break on the SO-DIMM slot connector. By a slanted angle, fully plug the memory module until it cannot be plugged any more.



Align the memory module's key notch at the SO-DIMM slot connector's break.

3. Press down the memory module until it is auto-locked in place.



---

#### 4.2.4. Install M.2 SSD

This page is intentionally left blank.

The computer comes with a M.2 socket for M.2 SSD installation. It supports form factors of 22x42 and 22x80.

1. Locate the memory socket of the computer.

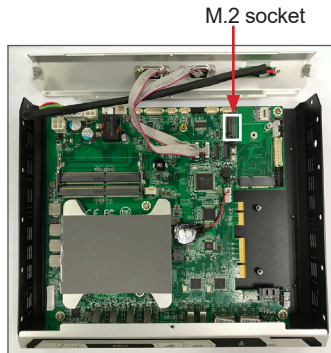

2. Align the M.2 SSD's key notch with the socket's notch. By a slanted angle, fully plug the SSD into the socket.

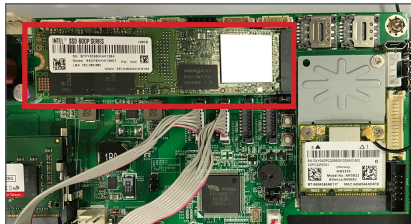

3. Press down the SSD until it is auto-locked in place. Then fasten the screw to secure the SSD.

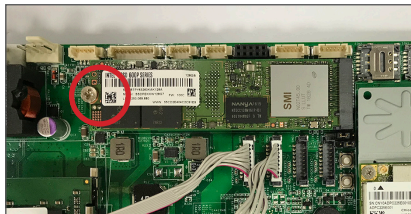



### 4.3. Wall Mounting (optional)

The computer comes with wall mount kit as standard accessory. If you need to attach the wall mount brackets to the computer, follow the instructions below:

1. Position the computer with the bottom side facing up.
2. Align the screw holes of the wall mount bracket with the ones of the main unit. Using the screws included in the wall mount kit, fasten the wall mount bracket to the computer's bottom case.
3. Repeat the step above to secure another wall mount bracket.
4. When the bracket is attached, the computer can be hanged on the wall as the way you want.

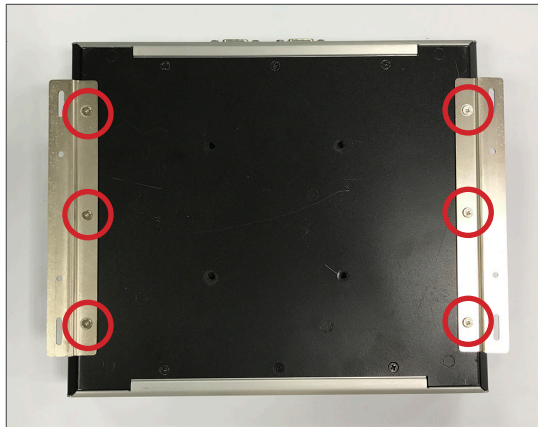

---

This page is intentionally left blank.

---

# Chapter 5

## BIOS

# BIOS

The BIOS Setup utility is featured by American Megatrends Inc to configure the system settings stored in the system's BIOS ROM. The BIOS is activated once the computer powers on. When the computer is off, the battery on the main board supplies power to BIOS RAM.

To enter the BIOS Setup utility, keep hitting the "Delete" key upon powering on the computer.

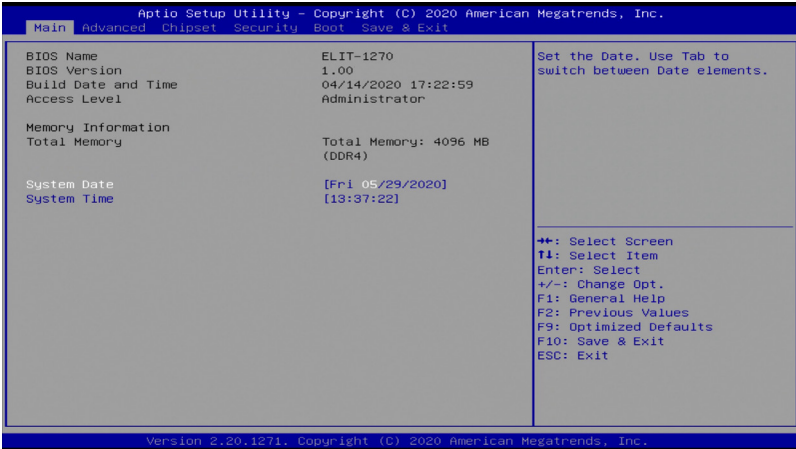

Menu	Description
Main	See <a href="#">5.1. Main</a> on page 48
Advanced	See <a href="#">5.2. Advanced</a> on page 49
Chipset	See <a href="#">5.3. Chipset</a> on page 62
Security	See <a href="#">5.4. Security</a> on page 64
Boot	See <a href="#">5.5. Boot</a> on page 67
Save & Exit	See <a href="#">5.6. Save &amp; Exit</a> on page 69

## Key Commands

The BIOS Setup utility relies on a keyboard to receive user's instructions. Hit the following keys to navigate within the utility and use the utility.

Keystroke	Function
← →	Moves left/right between the top menus.
↓ ↑	Moves up/down between highlight items.
<b>Enter</b>	Selects an highlighted item/field.
<b>Esc</b>	<ul style="list-style-type: none"> <li>▶ On the top menus: Use <b>Esc</b> to quit the utility without saving changes to CMOS. (The screen will prompt a message asking you to select <b>OK</b> or <b>Cancel</b> to exit discarding changes.</li> <li>▶ On the submenus: Use <b>Esc</b> to quit current screen and return to the top menu.</li> </ul>
<b>Page Up / +</b>	Increases current value to the next higher value or switches between available options.
<b>Page Down / -</b>	Decreases current value to the next lower value or switches between available options.
<b>F1</b>	Opens the <b>Help</b> of the BIOS Setup utility.
<b>F2</b>	Restore previous values.
<b>F9</b>	Restore optimized defaults
<b>F10</b>	Exits the utility saving the changes that have been made. (The screen then prompts a message asking you to select <b>OK</b> or <b>Cancel</b> to exit saving changes.)

Note: Pay attention to the "WARNING" that shows at the left pane onscreen when making any change to the BIOS settings.

This BIOS Setup utility is updated from time to time to improve system performance and hence the screenshots hereinafter may not fully comply with what you actually have onscreen.

## 5.1. Main

The **Main** menu features the settings of **System Date** and **System Time** and displays some BIOS info.

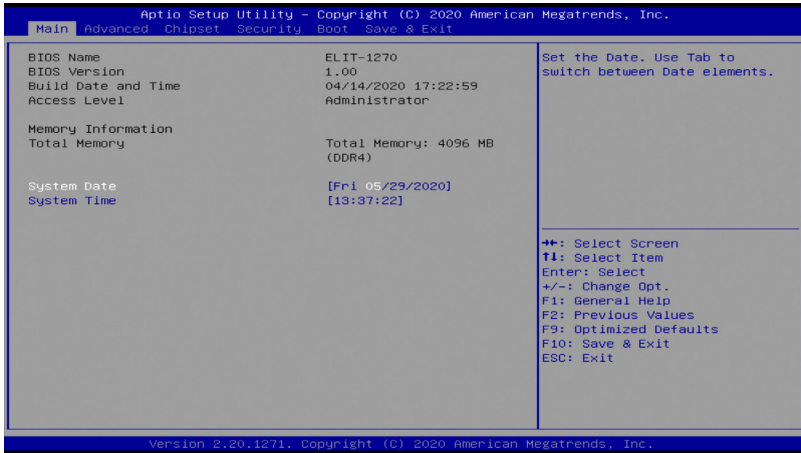

Setting	Description
<b>BIOS Name</b>	Delivers the model name of the computer.
<b>BIOS Version</b>	Delivers the computer's BIOS version.
<b>Build Date and Time</b>	Delivers the date and time when the BIOS Setup utility was made/ updated.
<b>Access Level</b>	Delivers the level that the BIOS is being accessed at the moment.
<b>Memory Information</b>	Delivers the information of total memory information..
<b>System Date</b>	Sets system date.
<b>System Time</b>	Sets system time.

## 5.2. Advanced



Setting	Description
AMD CBS	See <a href="#">5.2.1. AMD CBS</a> on page <a href="#">50</a>
CPU Configuration	See <a href="#">5.2.1. CPU Configuration</a> on page <a href="#">51</a>
ACPI Configuration	See <a href="#">5.2.4. ACPI Settings</a> on page <a href="#">52</a>
Trusted Computing	See <a href="#">5.2.4. Trusted Computing</a> on page <a href="#">53</a>
USB Configuration	See <a href="#">5.2.5. USB Configuration</a> on page <a href="#">54</a>
NVMe Configuration	See <a href="#">5.2.6. NVME Configuration</a> on page <a href="#">55</a>
Network Stack Configuration	See <a href="#">5.2.7. Network Stack Configuration</a> on page <a href="#">56</a>
IDE Configuration	See <a href="#">5.2.8. IDE Configuration</a> on page <a href="#">57</a>
Super IO Configuration	See <a href="#">5.2.6. Super IO Configuration</a> on page <a href="#">58</a>
Hardware Monitor	See <a href="#">5.2.7. Hardware Monitor</a> on page <a href="#">59</a>
S5 RTC Wake Settings	See <a href="#">5.2.8. S5 RTC Wake Settings</a> on page <a href="#">60</a>
CSM Configuration	See <a href="#">5.2.9. CSM Configuration</a> on page <a href="#">61</a>

### 5.2.1. AMD CBS

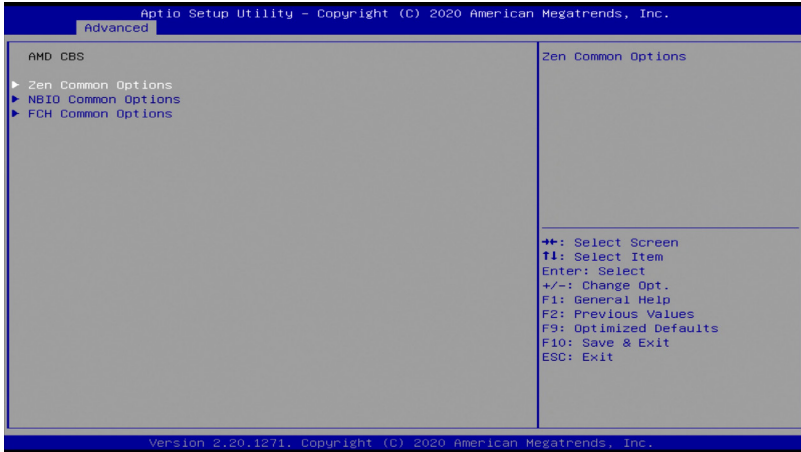

Setting	Description
<b>Zen Common Options</b>	
<b>Core Performance Boost</b>	<b>Enabled / Disable</b> (default) CPB.
<b>Global C-State Control</b>	Controls IO based C-state generation and DF C-states. ▶ Options: <b>Enabled / Disabled</b> (default)
<b>NBIO Common Options &gt;GFX Configuration</b>	
<b>Integrated Graphics Controller</b>	Enables integrated graphics controller. ▶ Options: <b>Disabled, Forces and Auto</b> (default)
<b>FCH Common Options &gt; AC Power Loss Options</b>	
<b>Power On After Power Fail</b>	Specify what state to go to when power is re-applied after a power failure. ▶ Options: <b>Power Off, Power on</b> (default) and <b>Last State</b>



## 5.2.2. CPU Configuration

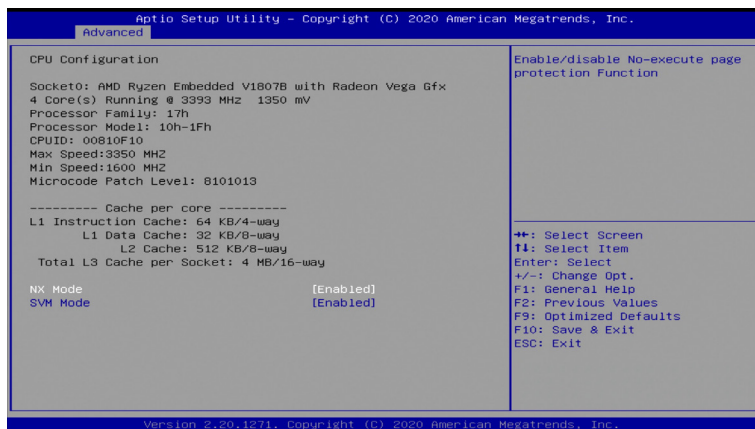

Setting	Description
NX Mode	Enable (default) / Disable No-execute page protection function.
SVM Mode	Enable (default) / Disable CPU virtualization.

### 5.2.3. ACPI Settings

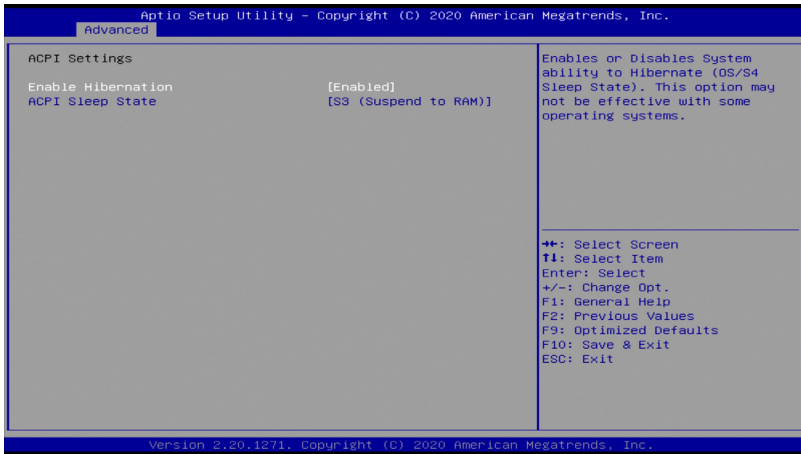

Setting	Description
Enable Hibernation	<b>Enables</b> (default) or <b>Disables</b> System ability to Hibernate (OS/S4 Sleep State). This option may be not effective with some OS.
ACPI Sleep State	Select ACPI sleep state the system will enter when the SUSPEND button is pressed. ► <b>Options: Suspend Disabled and S3 (Suspend to RAM)</b> (default)

## 5.2.4. Trusted Computing

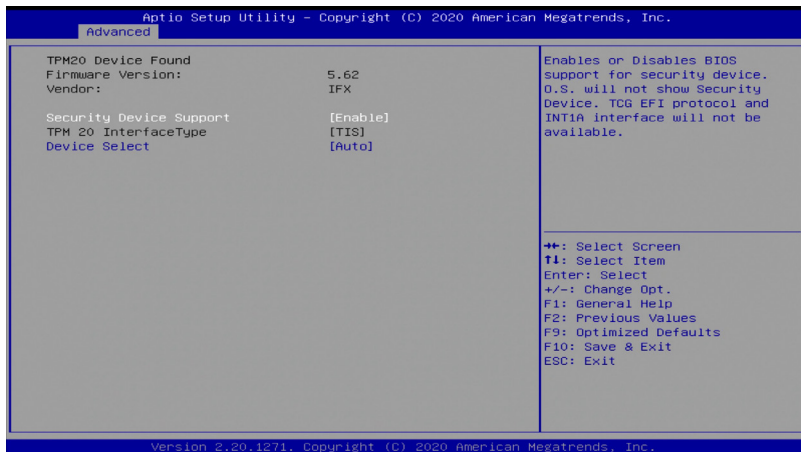

Setting	Description
Security Device Support	Enable (default) or Disable BIOS support for security device.
Device Select	<p>Sets the security device.</p> <ul style="list-style-type: none"> <li>Options: <b>TPM 1.2</b>, <b>TPM 2.0</b> and <b>Auto</b> (default).</li> <li>TP 1.2 will restrict support to TPM 1.2 devices.</li> <li>TPM 2.0 will restrict support to TPM 2.0 devices.</li> <li>Auto will support both with the defaults set to TPM 2.0 devices if not found, TPM 1.2 devices will be enumerated.</li> </ul>

### 5.2.5. USB Configuration

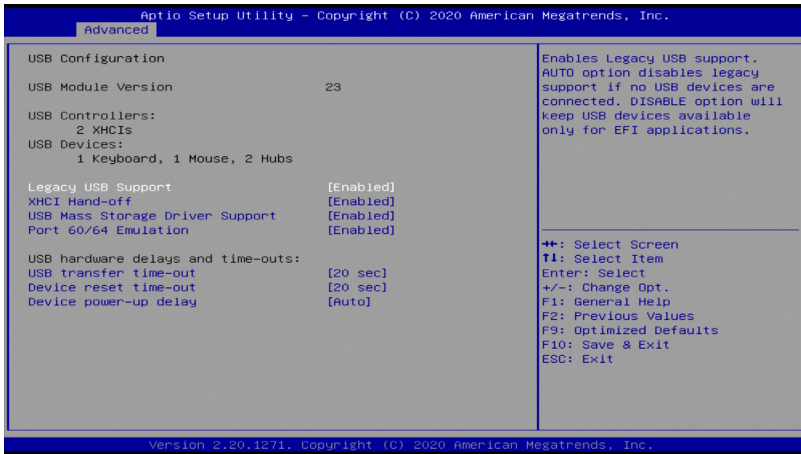

Setting	Description
<b>Legacy USB Support</b>	<p>Enables/disables legacy USB support.</p> <ul style="list-style-type: none"> <li>▶ Options available are <b>Enabled</b> (default), <b>Disabled</b> and <b>Auto</b>.</li> <li>▶ Select <b>Auto</b> to disable legacy support if no USB device are connected.</li> <li>▶ Select <b>Disabled</b> to keep USB devices available only for EFI applications.</li> </ul>
<b>XHCI Hand-off</b>	<p>This is a workaround for OSes without XHCI hand-off support. The XHCI ownership change should be claimed by XHCI driver.</p> <ul style="list-style-type: none"> <li>▶ The optional settings are: <b>Enabled</b> (default) / <b>Disabled</b>.</li> </ul>
<b>USB Mass Storage Driver Support</b>	<p>Enables/disables USB Mass Storage Driver Support.</p> <ul style="list-style-type: none"> <li>▶ The optional settings are: <b>Enabled</b> (default) / <b>Disabled</b>.</li> </ul>
<b>USB hardware delay and time-out</b>	
<b>USB transfer time-out</b>	<p>Use this item to set the time-out value for control, bulk, and interrupt transfers.</p> <ul style="list-style-type: none"> <li>▶ Options: <b>1 sec, 5 sec, 10 sec, 20 sec</b> (default)</li> </ul>
<b>Device reset time-out</b>	<p>Use this item to set USB mass storage device start unit command time-out.</p> <ul style="list-style-type: none"> <li>▶ Options available are: <b>10 sec, 20 sec</b> (default), <b>30 sec, 40 sec</b></li> </ul>

**Device power-up delay**

Use this item to set maximum time the device will take before it properly reports itself to the host controller. 'Auto' uses default value: for a root port it is 100 ms, for a hub port the delay is taken from hub descriptor.

► Options available are:

**Auto:** Default

**Manual:** Select **Manual** you can set value for the following sub-item: 'Device Power-up delay in seconds', the delay range in from 1 to 40 seconds, in one second increments.

## 5.2.6. NVME Configuration

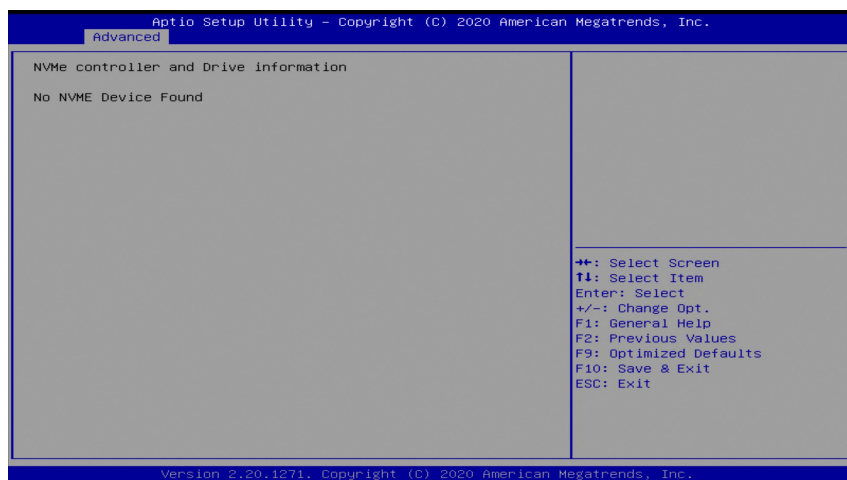

Access this submenu to view the NVMe controller and driver information.

## 5.2.7 Network Stack Configuration

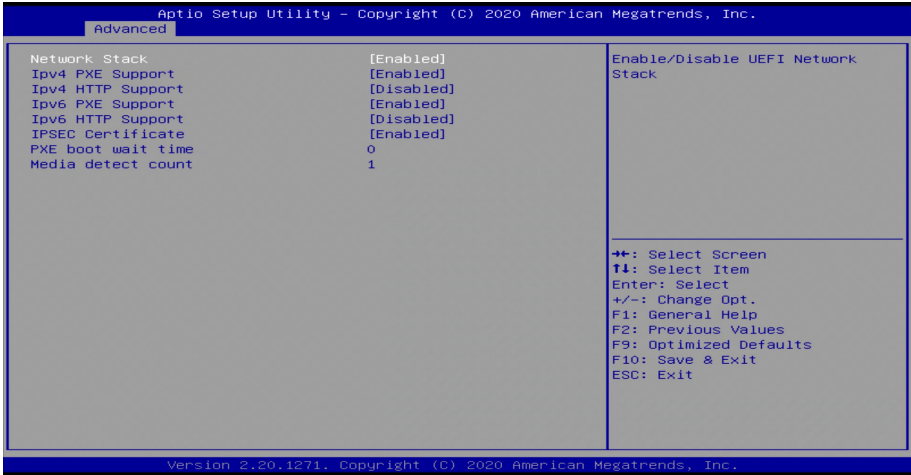

Setting	Description
<b>Network Stack</b>	<b>Enable</b> (default) or <b>Disable</b> UEFI network stack.
<b>IPv4 PXE Support</b>	<b>Enable</b> (default) or <b>Disable</b> IPv4 PXE boot Support.
<b>IPv4 HTTP Support</b>	<b>Enable</b> or <b>Disable</b> (default) IPv4 HTTP boot support. If disabled, IPv4 HTTP boot support will not be available.
<b>IPv6 PXE Support</b>	Enables/disables IPv6 PXE boot Support. ▶ <b>Enabled</b> is the default.
<b>IPv6 HTTP Support</b>	<b>Enable</b> or <b>Disable</b> (default) IPv6 HTTP boot support. If disabled, IPv4 HTTP boot support will not be available.
<b>IPSEC Certificate</b>	Support to <b>Enable</b> (default) or <b>Disable</b> IPSEC certificate for Ikev.
<b>PXE boot wait time</b>	Set the wait time in seconds to press ESC key to abort the PXE boot. ▶ <b>0</b> is the default.
<b>Media detect time</b>	Setup wait time in sec to detect the presence of media.

## 5.2.8 IDE Configuration

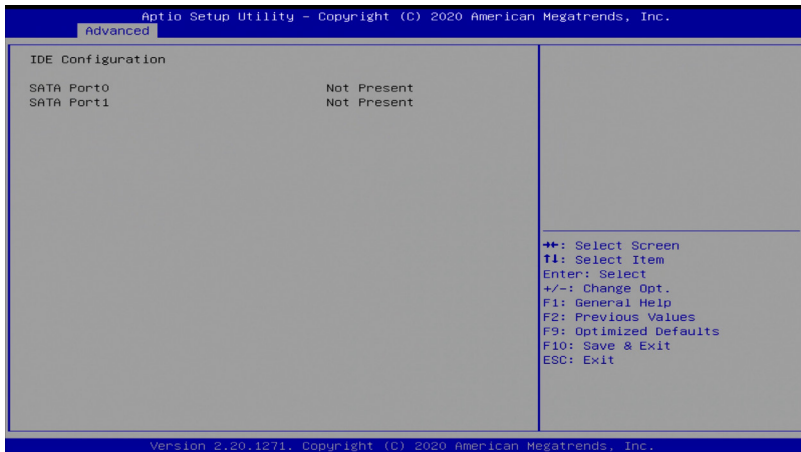

Access this submenu to view the SATA device information

## 5.2.9. Super IO Configuration

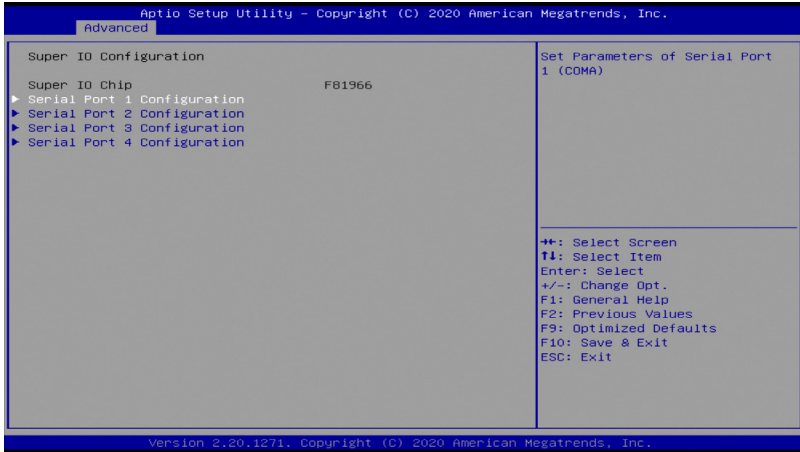

Setting	Description
<b>Serial Port 1~4 Configuration</b>	
<b>Serial Port</b>	<b>Enable</b> (default) or <b>Disable</b> Serial Port (COM).
<b>Change Settings</b>	Select an optimal setting for Super IO device. <ul style="list-style-type: none"> <li>▶ <b>Port 1 default:</b> <b>IO=3F8h; IRQ=4</b></li> <li>▶ <b>Port 2 default:</b> <b>IO=2F8h; IRQ=3</b></li> <li>▶ <b>Port 3 default:</b> <b>IO=3E8h; IRQ=7</b></li> <li>▶ <b>Port 4 default:</b> <b>IO=2E8h; IRQ=7</b></li> </ul>
<b>Mode Select</b>	Only for Serial Port 1/2 Select <b>RS-232</b> (default), <b>RS-422</b> , <b>RS-485</b> , <b>RS-422 Termination Resistor</b> or <b>RS-485 Termination Resistor</b>



## 5.2.10. Hardware Monitor

Select this submenu to view the main board’s hardware status. Select it to run a report of various info as depicted below:

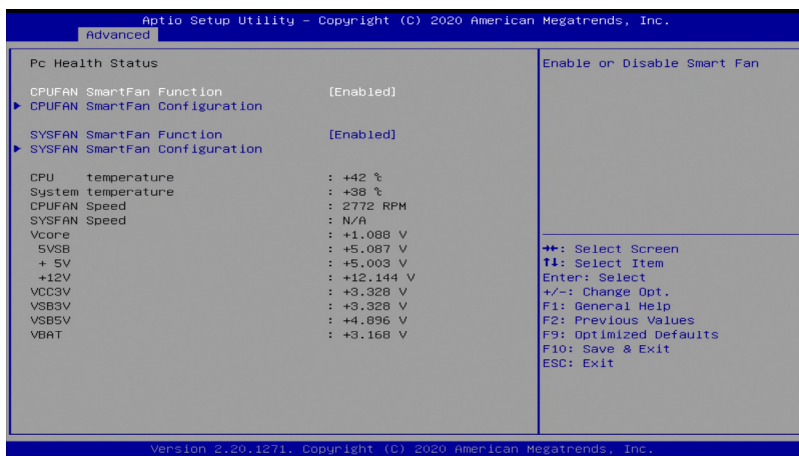

Setting	Description
<b>CPUFAN SmartFan Function</b>	<b>Enables</b> (default) or <b>Disables</b> Smart Fan
<b>CPUFAN SmartFan Configuration`</b>	<b>Temperature 1~4 &amp; RPM Percentage 1~4</b> Auto fan speed control. Fan speed will follow different temperature by different PRM 1-100.
<b>SYSFAN SmartFan Function</b>	<b>Enables</b> (default) or <b>Disables</b> Smart Fan
<b>SYSFAN SmartFan Configuration`</b>	<b>Temperature 1~4 &amp; RPM Percentage 1~4</b> Auto fan speed control. Fan speed will follow different temperature by different PRM 1-100.

**Note:** CPUFAN & SYSFAN functions only apply to SKUs with smart fan. If your SKU doesn't come with smart fan, ignore these settings.

### 5.2.11. S5 RTC Wake Settings

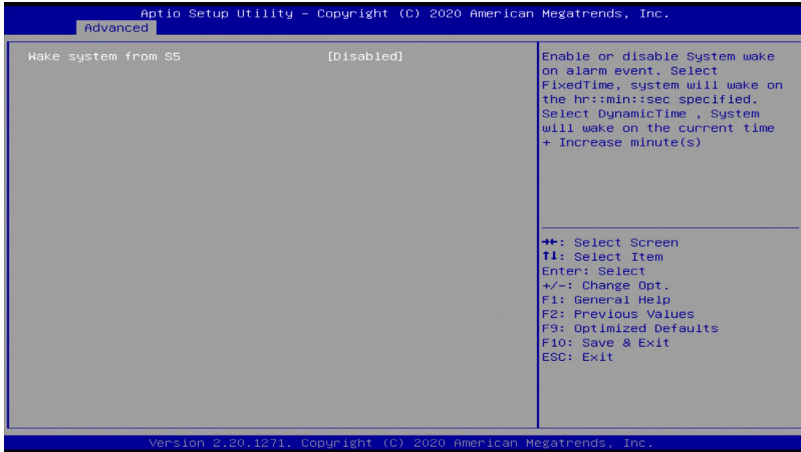

Setting	Description
<b>Wake System from S5</b>	<p><b>Enable or Disable</b> (default) system wake on alarm event.</p> <ul style="list-style-type: none"> <li>Options available are:                             <ul style="list-style-type: none"> <li><b>Disabled</b> (default):</li> <li><b>Fixed Time:</b> System will wake on the hr::min::sec specifiedc.</li> <li><b>DynamicTime:</b> If selected, you need to set <b>Wake up minute increase</b> from 1 - 5. System will wake on the current time + increase minute(s).</li> </ul> </li> </ul>

## 5.2.12. CSM Configuration

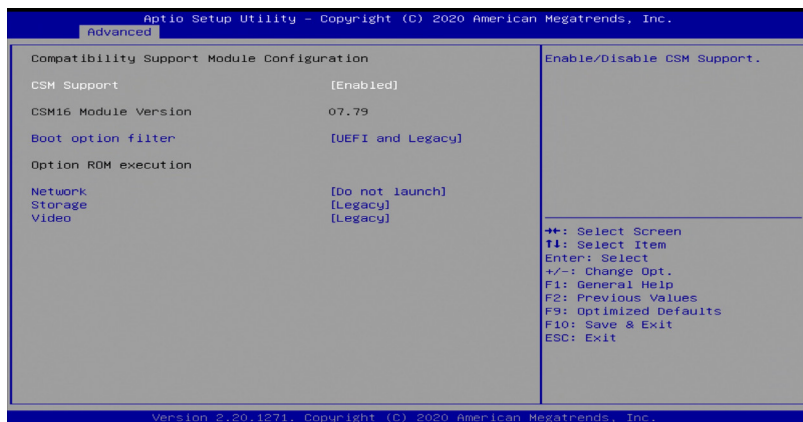

Setting	Description
<b>CSM Support</b>	<b>Enable</b> (default) or <b>Disable</b> CSM Support.
<b>Boot option filter</b>	Control the Legacy/UEFI ROMs priority. ▶ Options: <b>UEFI and Legacy</b> (default), <b>Legacy only</b> , <b>UEFI only</b>
<b>Network</b>	Control the execution of UEFI and Legacy PXE OpROM ▶ Options: <b>Do not launch</b> (default) UEFI and <b>Legacy</b>
<b>Storage</b>	Control the execution of UEFI and Legacy Storage OpROM ▶ Options: <b>Do not launch</b> , UEFI, and <b>Legacy</b> (default)
<b>Video</b>	Control the execution of UEFI and Legacy Video OpROM ▶ Options: <b>Do not launch</b> , UEFI and <b>Legacy</b> (default)

### 5.3. Chipset



Setting	Description
SB USB Configuration	See <a href="#">5.3.1. Graphics Configuration</a> on page 65

### 5.3.1. SB USB Configuration

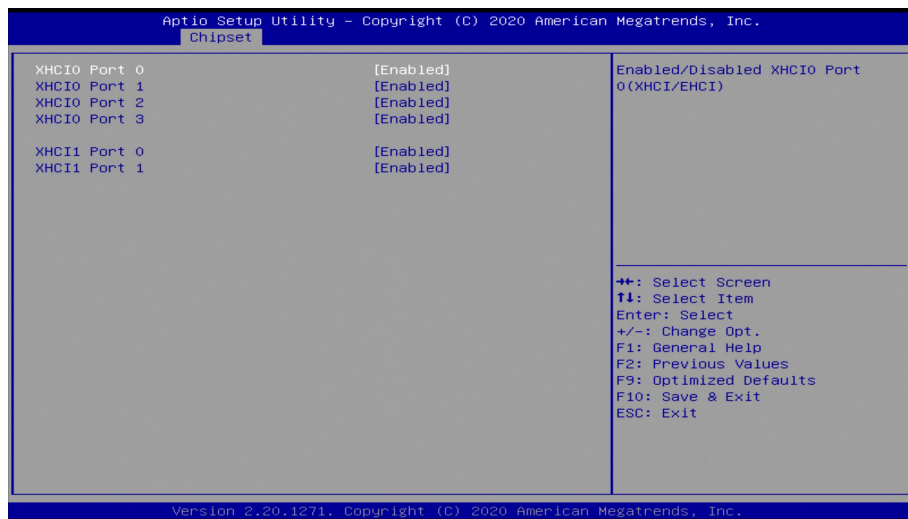

Setting	Description
XHCI0 Port 0~3	Enable (default) or Disable XHCI0 Port 0~3(XHCI/EHCI)
XHCI1 Port 0/1	Enable (default) or Disable XHCI1 Port 0~1(XHCI/EHCI)

## 5.4. Security

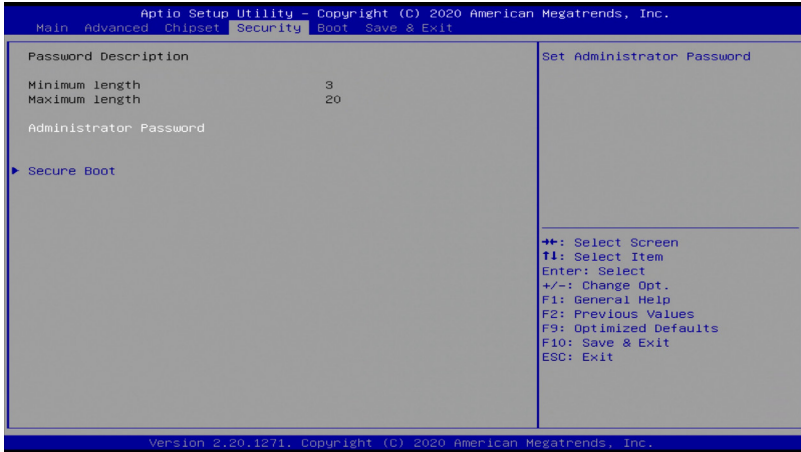

Setting	Description
<b>Administrator Password</b>	<p>To set up an administrator password:</p> <ol style="list-style-type: none"> <li>1. Select <b>Administrator Password</b>.</li> <li>2. An <b>Create New Password</b> dialog then pops up onscreen.</li> <li>3. Enter your desired password that is no less than 3 characters and no more than 20 characters.</li> <li>4. Hit [Enter] key to submit.</li> </ol>
<b>Secure Boot</b>	See <a href="#">5.4.1 Secure Boot</a> on page <a href="#">65</a>

### 5.4.1. Secure Boot



Setting	Description
<b>Secure Boot</b>	<p><b>Enable</b> or <b>Disable</b> (default) Secure Boot.</p> <p>Secure Boot activated when</p> <ul style="list-style-type: none"> <li>- Secure Boot is enabled</li> <li>- Platform Key (PK) is enrolled.</li> <li>- System mode is user/deployed, and CSM is disabled.</li> </ul>
<b>Secure Customization</b>	<p>Customization Secure Boot mode:</p> <p>In custom mode Secure Boot Policy variables can be configured by a physically present user without full authentication.</p> <ul style="list-style-type: none"> <li>► Options: <b>Standard</b> / <b>Custom</b> (default)</li> </ul>
<b>Restore Factory Keys</b>	<p>Allows to force system to user mode. Configure NVRAM to contain OEM-defined factory default Secure Boot Keys.</p>
<b>Key Management</b>	<p>See <a href="#">5.4.2. Factory Key Provision</a> on page <a href="#">66</a></p>

### 5.4.2. Factory Key Provision

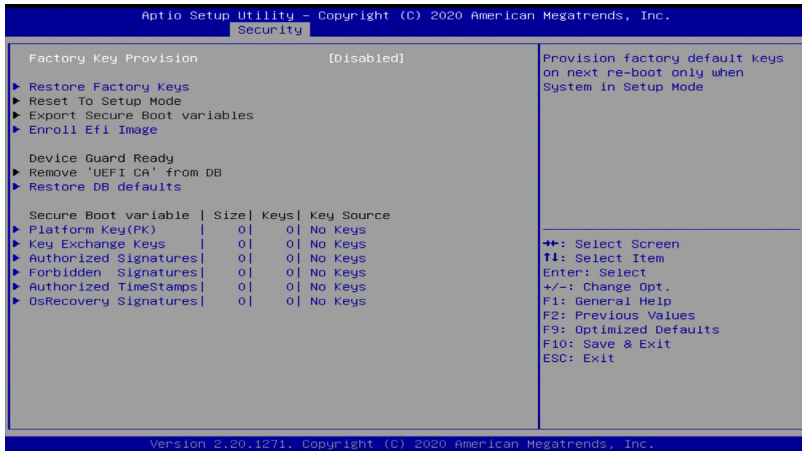

Setting	Description
<b>Factory Key Provision</b>	Provision factory default keys on next re-boot only when System in setup mode. ► Options: <b>Enabled, Disable</b> (default)
<b>Restore Factory Keys</b>	Allows to force system to user mode. Configure NVRAM to contain OEM-defined factory default Secure Boot Keys.
<b>Enroll Efi Image</b>	Allow the image to run in Secure Boot mode. Enroll SHA265 Hash certification of a PE image into authorized signature database (db).
<b>Restore DB defaults</b>	Allow to restore DB variable to factory defaults.
<b>Platform Key (PK) Key Exchange Keys Authorized Signatures Forbidden Signatures Authorized TimeStamps OsRecovery Signatures</b>	Enroll factory defaults or load certificates from a file: 1. Public Key Certificate in: a) EFI_SIGNATURE_LIST b) EFI_CERT_X509 (DER encoded) c) EFI_CERT_RSA2048 (bin) d) EFI_CERT_SHA256, 384, 512 2. Authenticated UEFI Variable 3. EFI PE/COFF Image (SHA256) Key Source: Factory, External, Mixed ► Options: <b>Update, Append</b> (For Platform Key (PK), only <b>Update</b> option available.)



## 5.5. Boot

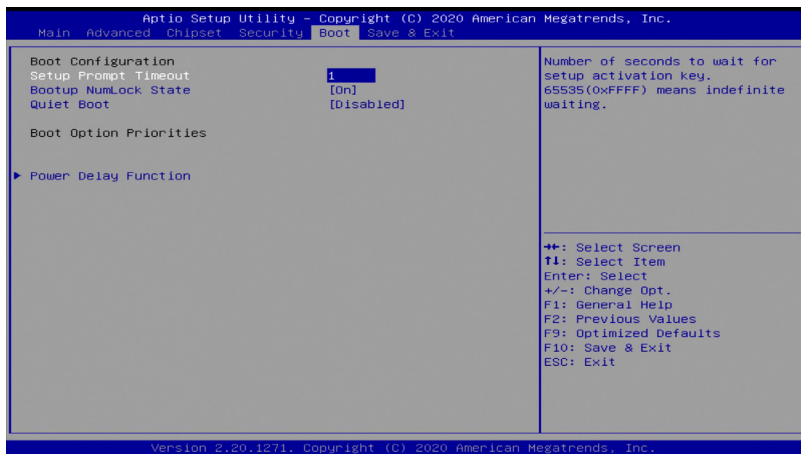

Setting	Description
<b>Setup Prompt Timeout</b>	<p>Set how long to wait for the prompt to show for entering BIOS Setup.</p> <ul style="list-style-type: none"> <li>▶ The default setting is <b>2</b> (sec).</li> <li>▶ Set it to <b>65535</b> to wait indefinitely.</li> </ul>
<b>Bootup NumLock State</b>	<p>Sets whether to enable or disable the keyboard's NumLock state when the system starts up.</p> <ul style="list-style-type: none"> <li>▶ Options available are <b>On</b> (default) and <b>Off</b>.</li> </ul>
<b>Quiet Boot</b>	<p>Sets whether to display the POST (Power-on Self Tests) messages or the system manufacturer's full screen logo during booting.</p> <ul style="list-style-type: none"> <li>▶ Select <b>Disabled</b> to display the normal POST message, which is the default.</li> </ul>

<p><b>Power Delay Function</b></p>	<p><b>Power Delay Function</b> Set the system support power delay function.</p> <ul style="list-style-type: none"><li>▶ Options: <b>Enable</b> (default): Support power delay function. <b>Disable</b>: Power on/off manually operated.</li></ul> <p><b>Power on delay</b> Select the time which the system will power on.</p> <ul style="list-style-type: none"><li>▶ Options: <b>Manually Operator</b> (default), <b>04 Seconds</b>, <b>08 Seconds</b> and <b>16 Seconds</b>.</li></ul> <p><b>Power off delay</b> Select the time which the system will shutdown.</p> <ul style="list-style-type: none"><li>▶ Options: <b>Manually Operator</b> (default), <b>30 Seconds</b>, <b>60 Seconds</b> and <b>90 Seconds</b>.</li></ul> <p>* This setting is reserved.</p>
------------------------------------	---

## 5.6. Save & Exit



Setting	Description
<b>Save Changes and Reset</b>	Saves the changes and quits the BIOS Setup utility.
<b>Discard Changes and Exit</b>	Quits the BIOS Setup utility without saving the change(s).
<b>Restore Defaults</b>	Restores all settings to defaults. ▶ This is a command to launch an action from the BIOS Setup utility.
<b>Launch EFI Shell from filesystem device</b>	▶ Attempts to launch EFI Shell Application (Shell.efi) from one of the available filesystem devices.