



# User's Manual

## PPC-150T-EHL

Intel® Elkhart Lake Processor

Compact Panel PC with 15" Resistive Touch Screen

PPC-150T-EHL-J6-8G

PPC-150T-EHL-J6-16G

PPC-150T-EHL-J6-32G

(Revision 1.1A)

# REVISION

DATE	VERSION	DESCRIPTION
2023/8/1	Version 1.0A	New Release
2024/1/22	Version 1.1A	Correct information to remove 2.5" HDD out in Ch. 3.

ICOP TECHNOLOGY INC.

# COPYRIGHT

The information in this manual is subject to change without notice for continuous improvement in the product. All rights are reserved. The manufacturer assumes no responsibility for any inaccuracies that may be contained in this document, and makes no commitment to update or to keep current the information contained in this manual.

No part of this manual may be reproduced, copied, translated or transmitted, in whole or in part, in any form or by any means without the prior written permission of the ICOP Technology Inc.

©Copyright 2024 ICOP Technology Inc.  
Manual # IUMPPC150TEHL-01 Ver.1.1A Jan, 2024

# TRADEMARKS ACKNOWLEDGMENT

Intel® Elkhart Lake is the registered trademark of Intel Corporation. Other brand names or product names appearing in this document are the properties and registered trademarks of their respective owners. All names mentioned herewith are served for identification purpose only.

For more detailed information or if you are interested in other ICOP products, please visit our official websites at:

- Global: [www.icop.com.tw](http://www.icop.com.tw)
- USA: [www.icoptech.com](http://www.icoptech.com)
- Japan: [www.icop.co.jp](http://www.icop.co.jp)
- Europe: [www.icoptech.eu](http://www.icoptech.eu)
- China: [www.icop.com.cn](http://www.icop.com.cn)

For technical support or drivers download, please visit our websites at:

- [https://www.icop.com.tw/resource\\_entrance](https://www.icop.com.tw/resource_entrance)

This Manual is for the PPC-150T-EHL series.

# SAFETY INFORMATION

- Read these Safety instructions carefully.
- Please carry the unit with both hands, handle carefully.
- Make sure the voltage of the power source is correct before connecting the equipment to the power outlet.
- Do not expose your Panel PC to rain or moisture in order to prevent shock and fire hazard.
- Input voltage +12~24VDC Power Adapter Only
- Operating temperature between 0~+60°C.
- Keep PPC-150T-EHL away from humidity.
- When a M.2 SSD storage is the main operating system storage, please turn off power before inserting or removing. Do not open the cabinet to avoid electrical shock. Refer to your nearest dealer for qualified personnel servicing.
- Never touch un-insulated terminals or wire unless your power adaptor is disconnected.
- Locate your Panel PC as close as possible to the socket outline for easy access and to avoid force caused by entangling of your arms with surrounding cables from the Panel PC.
- USB connectors are not supplied with Limited Power Sources.
- If the equipment is not used for a long time, disconnect it from the power source to avoid damage by transient overvoltage.

## **WARNING!**



*DO NOT ATTEMPT TO OPEN OR TO DISASSEMBLE THE CHASSIS (ENCASING) OF THIS PRODUCT. PLEASE CONTACT YOUR DEALER FOR SERVICING FROM QUALIFIED TECHNICIAN.*

# Content

Content .....	iv
Ch. 1 General Information .....	1
1.1 Product Description .....	2
1.2 Product Specifications .....	3
1.3 Inspection standard for TFT-LCD Panel .....	5
1.4 Product Dimensions.....	8
1.5 Mounting Instruction .....	9
1.6 Ordering Information.....	11
Ch. 2 System Installation.....	13
2.1 CPU Board Outline .....	14
2.2 Connector Summary.....	15
2.3 Connector Pin Assignments.....	16
2.4 External I/O Overview.....	17
2.5 External I/O Pin Assignment.....	18
Ch. 3 Hardware Installation.....	20
3.1 Installing the M.2 M-key (2242/2280) Storage .....	21
3.2 Installing the M.2 B-Key (3024) and M.2 E-Key (2230) Modules .....	24
3.3 Installing the Micro SIM Card (Must have 3G/4G of M.2 B-key (3024) Module in advance).....	26
Ch. 4 Drivers and BIOS Instruction .....	27
4.1 Operating System Support and Drivers .....	28
4.2 BIOS Hot Key .....	29
4.3 BIOS COM1 Setting (RS232/422/485).....	30
4.4 BIOS COM2 Setting (Change Settings).....	32
4.5 BIOS AT Mode Setting (Support Auto-Power On Function).....	34
4.6 BIOS Serial Port Console Redirection.....	36
4.7 BIOS Load Default Setting.....	38
Warranty.....	40

# Ch. 1

## General Information

[1.1 Product Description](#)

[1.2 Product Specifications](#)

[1.3 Inspection standard for TFT-LCD Panel](#)

[1.4 Product Dimensions](#)

[1.5 Mounting Instruction](#)

[1.6 Ordering Information](#)

# 1.1 Product Description

ICOP Technology Inc. is proudly going to release a brand new Panel PC, which offers fanless design, low power consumption, and IP65 front panel. The PPC-150T-EHL is powered by Intel® Elkhart Lake J6412 processors, and up to 32GB of SO-DIMM DDR4 module that handles processing more efficiently and provides faster performance. The project capacity touch panel with LED backlight TFT LCD increases operation convenience and visibility in outdoor environments. The ultra-compact and thin exterior design is perfect for the present demanding embedded and productive applications.

The new PPC-150T-EHL inherited PPC series' smooth appearance and ultra-texture aluminum exterior design to make your industrial applications look more stylish. The versatile I/O ports, IP65 front panel, 2.5GIGA high-speed Ethernet etc. can fulfill fundamental functions. Our consistent advantages feature stable performance, extended working temperature support, low power consumption and fanless design. The expandable customize I/O ports can be accommodated connectivity requirements to industrial machine platforms and industrial automation equipment's needs.

The PPC-150T-EHL supports Windows 10, Windows 10 IoT, Windows 11 and Linux to meet ready-to-market demand and provide competitive advantages for customers.

# 1.2 Product Specifications

## CPU BOARD SPECIFICATIONS

CPU	Intel® Elkhart Lake J6412 (Quad core)
Cache	L2: 1.5MB Cache
BIOS	AMI BIOS
Memory	8GB / 16GB / 32GB DDR4
Display	Intel® HD Graphics, HDMI x 2
LAN	Intel® i225-V 2.5GbE x 2
Audio	HD Audio-Realtek ALC888S
Internal Drives	M.2 M-key (2242/2280) PCIe Gen. 3 *2 / SATA interface support NVME
Expansion I/O	M.2 B-key (3024) USB3.1/USB2.0 interface M.2 E-key (2230) USB2.0/PCIe Gen3 *1 interface
I/O	HDMI x 2 RS232/422/485 (COM1) x 1 RS232 (COM2) x 1 USB3.1 (Gen. 2) x 3 USB2.0 x 3 RJ45 x 2 Phone Jack (Line-Out & Mic-In) x 1

## MECHANICAL & ENVIRONMENT

Power Requirement	+12~24 VDC Power Adatper Only <a href="#">(DC JACK 5.5x2.5mm plug support)</a>
Power Adapter	+12VDC@ 3.34A (40W)
Operating Temperature	0~+60°C
Storage Temperature	-30~+70°C
Operating Humidity	0% ~ 90% Relative Humidity, Non-Condensing



Dimensions	354.84x280.84x61.55mm (13.97"x11.06"x2.42")
Weight	4.02 Kg
Protection	IP65 Front Panel
Certification	CE / UKCA / FCC / VCCI / Vibration/ Shock

## LCD SPECIFICATIONS

Display Type	15" XGA TFT LCD
Backlight Unit	LED
Display Resolution	1024(W) x 768(H)
Brightness (cd/m <sup>2</sup> )	350 nits
Contrast Ratio	800 : 1
Display Color	262,144
Pixel Pitch (mm)	0.297 (H) x 0.297 (V)
Viewing Angle	Vertical 160°, Horizontal 160°
Backlight Lifetime	30,000 hrs

## TOUCHSCREEN

Type	Analog Resistive
Resolution	Continuous
Transmittance	80%
Controller	USB interface
Software Driver	Linux, Win10, Win10 IoT
Durability	1 million

# 1.3 Inspection standard for TFT-LCD Panel

DEFECT TYPE			LIMIT				Note	
VISUAL DEFECT	INTERNAL	SPOT	$\phi < 0.15\text{mm}$		Ignore		Note1	
			$0.15\text{mm} \leq \phi \leq 0.5\text{mm}$		$N \leq 4$			
			$0.5\text{mm} < \phi$		N=0			
		FIBER	$0.03\text{mm} < W \leq 0.1\text{mm}, L \leq 5\text{mm}$		$N \leq 3$		Note1	
			$1.0\text{mm} < W, 1.5\text{mm} < L$		N=0			
		POLARIZER BUBBLE	$\phi < 0.15\text{mm}$		Ignore		Note1	
			$0.15\text{mm} \leq \phi \leq 0.5\text{mm}$		$N \leq 2$			
			$0.5\text{mm} < \phi$		N=0			
		Mura	It' OK if mura is slight visible through 6%ND filter					
		ELECTRICAL DEFECT	BRIGHT DOT	A Grade			B Grade	
C Area	O Area			Total	C Area	O Area	Total	Note3
$N \leq 0$	$N \leq 2$			$N \leq 2$	$N \leq 2$	$N \leq 3$	$N \leq 5$	Note2
DARK DOT	$N \leq 2$		$N \leq 3$	$N \leq 3$	$N \leq 3$	$N \leq 5$	$N \leq 8$	
TOTAL DOT	$N \leq 4$			$N \leq 5$	$N \leq 6$	$N \leq 8$	Note2	
TWO ADJACENT DOT	$N \leq 0$		$N \leq 1$ pair	$N \leq 1$ pair	$N \leq 1$ pair	$N \leq 1$ pair	$N \leq 1$ pair	Note4
THREE OR MORE ADJACENT DOT	NOT ALLOWED							
LINE DEFECT	NOT ALLOWED							

(1) One pixel consists of 3 sub-pixels, including R, G, and B dot. (Sub-pixel = Dot)

(2) Little bright Dot acceptable under 6% ND-Filter.

**(3) If require G0 grand (Total dot  $N \leq 0$ ), please contact region sales.**

[ **Note 1** ] W: Width[mm]; L: Length[mm]; N: Number;  $\varphi$ : Average Diameter.

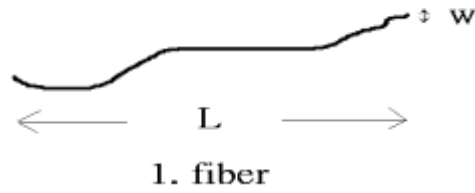
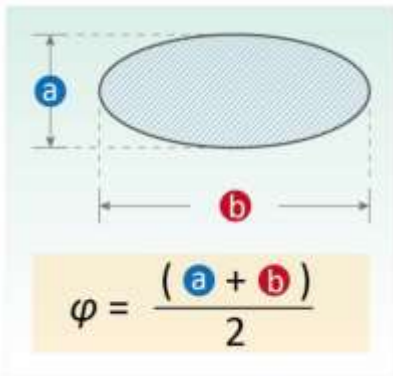

(a) White / Black Spot (b) Polarizer Bubble

[ **Note 2** ] Bright dot is defined through 6% transmission ND Filter as following.

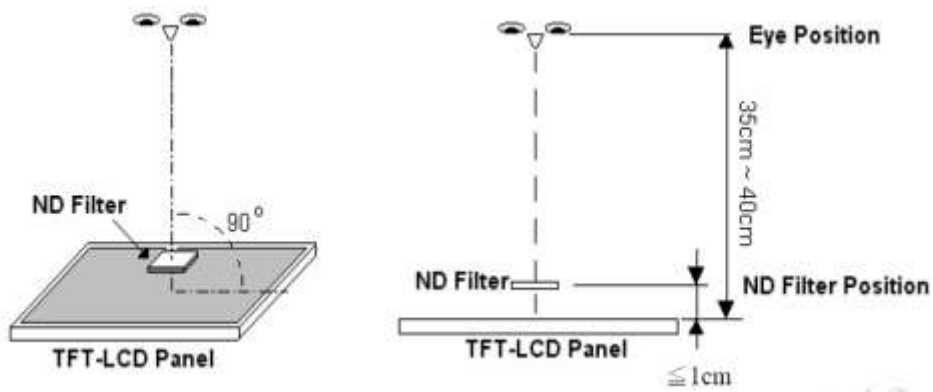

[ **Note 3** ] Display area

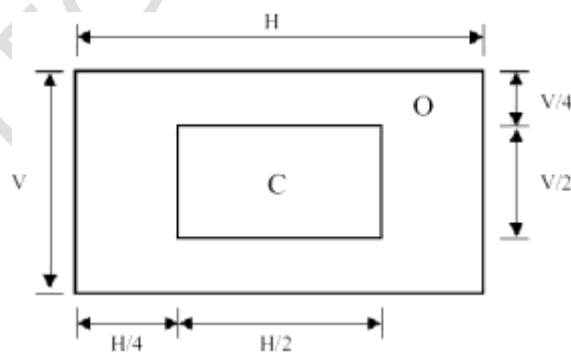

**C Area:** Center of display area    **O Area:** Outer of display area

**[ Note 4 ]** Judge the defect dot and the adjacent dot as following. Allow below (as A, B, C and D status) adjacent defect dots, including bright and dark adjacent dot. And they will be counted 2 defect dots in total quantity.

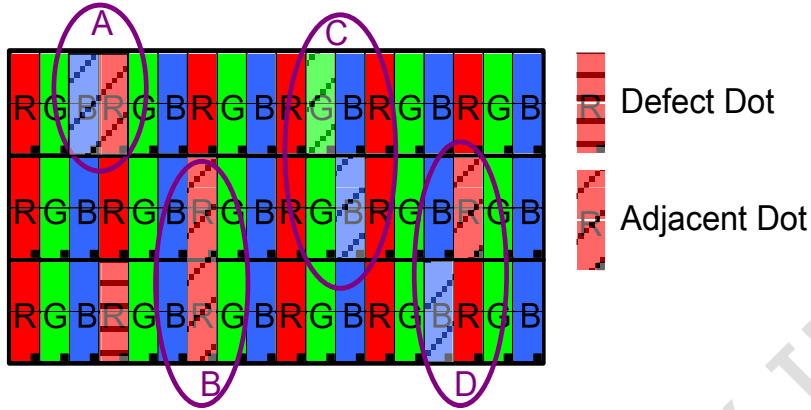

The defects that are not defined above and considered to be problem shall be reviewed and discussed by both parties.

Defects on the Black Matrix, out of Display area, are not considered as a defect or counted.

# 1.4 Product Dimensions

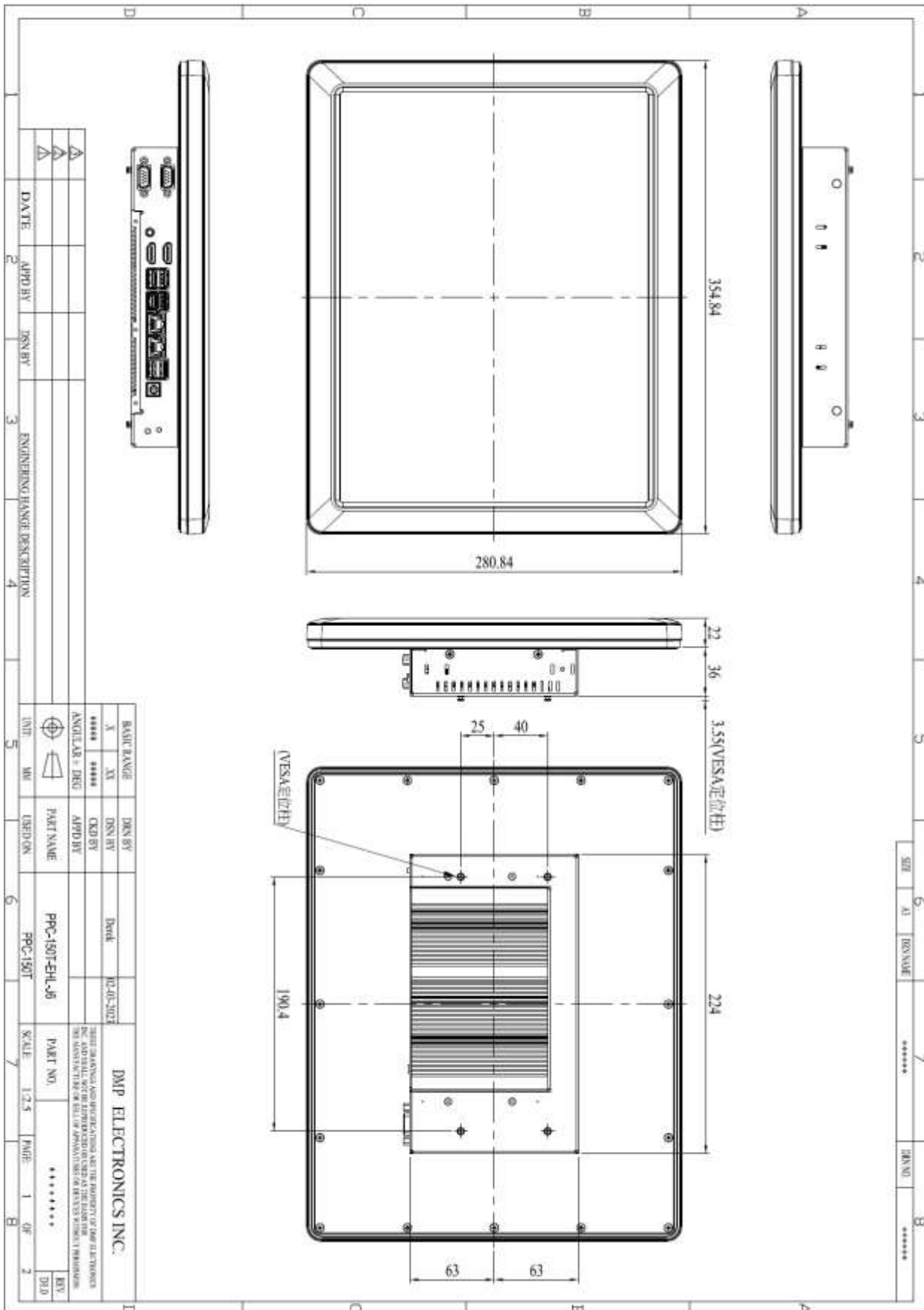

# 1.5 Mounting Instruction

- **1.5.1 VESA Mounting**

PPC-150T-EHL series support VESA Mount that is an optional for ordering. Please contact your region sales for ordering.

Ordering part number: **VESA-MT-PPC-EHL-SET**

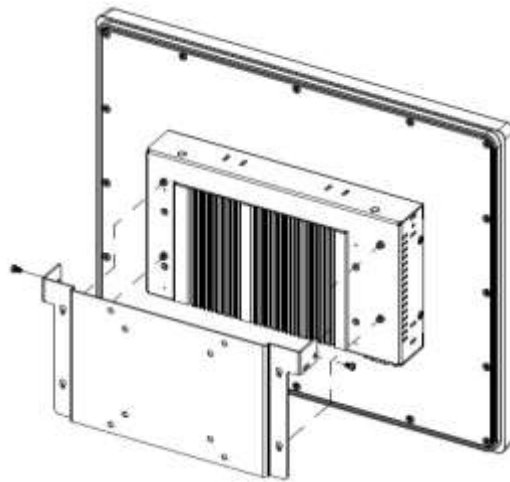

1. Place VESA bracket and VESA-MT-PPC-EHL-SET together.
2. Lock 4 screws and nuts on both of VESA bracket and VESA-MT-PPC-EHL-SET.



3. Hang PPC-150T-EHL upon on both of VESA bracket and VESA-MT-PPC-EHL-SET, and use 2 M3\*4 screws to lock the right and left side of the bracket.



## • 1.5.2 Panel Mounting

PPC-150T-EHL series support clamp mount that is an optional for ordering. Please contact your region sales for ordering.

Ordering part number: **PANEL-MT-PPC-APL-SET**

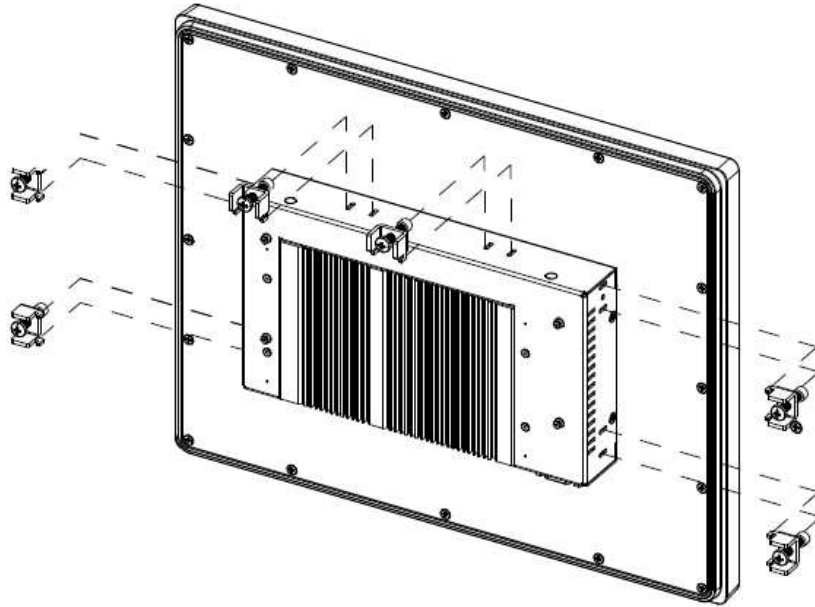

1. Please refer the Section 1.4 to make a cutout hole on your mechanical or frame. **Please note that there is thickness limitation of the mounting wall for clamp mount installation. The suggestion of mounting wall thickness limitation is 20 mm.**
2. **PANEL-MT-PPC-APL-SET** includes 6pcs of clamp and screw, and each clamp and screw is paired. Screws 6pcs of clamp and screw together respectively.
3. Place PPC in a cutout mechanical or frame, which mounts the panel to align the bottom of the panel housing with the bottom edge of the cutout. This way can help hold the panel steadily.
4. At the back side of the mounting wall, insert the clamp into the slide hole at the side bracket on the panel. Fit the screw on the clamp and screw on both of clamp and mounting wall. Please be careful and make sure that 6 clamps and screws have been lock tightly.

## 1.6 Ordering Information

Product Code	LCD Size	CPU Series	CPU Type	RAM
PPC	150T	EHL	J6	<b>8G</b> <b>16G</b> <b>32G</b>

**1. Product Code** : Code 1~3.

PPC : Panel PC Series.

**2. LCD Size** : Code 4~7.

150T : 15" LCD with Resistive touch screen.

**3. CPU Serial** : Code 8~10.

EHL: Intel Elkhart Lake Series.

**3. CPU Type** : Code 8~9.

J6: Intel Elkhart Lake J6412.(Standard; Quad Core 10W)

**4. RAM** : Code 10~11.

8G : 8GB.    16 : 16GB.    32 : 32GB

**PS: Power adapter and cord must be showed separate because different county has different power cord. The part numbers of power adapter and cord are as below.**

**(Please contact ICOP sales person or distributor to get the unit price of power adaper and cord. Thank you.)**

**POWER-12V3.34A-MW**

**POWERCABLE(A) / POWERCABLE(G)**



<b>PART NUMBER</b>	<b>DESCRIPTION</b>
<b>PPC-150T-EHL-J6-8G</b>	15" Panel PC w/Intel Elkhart Lake J6412/8GB DRAM /6U/2*2.5GbE LAN/2S/Resistive Touch
<b>PPC-150T-EHL-J6-16G</b>	15" Panel PC w/Intel Elkhart Lake J6412/16GB DRAM /6U/2*2.5GbE LAN/2S/Resistive Touch
<b>PPC-150T-EHL-J6-32G</b>	15" Panel PC w/Intel Elkhart Lake J6412/32GB DRAM /6U/2*2.5GbE LAN/2S/Resistive Touch
<b>POWER-12V3.34A-MW</b>	AC – DC power adapter / DC12V @ 3.34A (AC 90 ~ 240V Input)
<b>POWERCABLE(A) / POWERCABLE(G)</b>	US / Euro power cord for POWER-12V3.34A-MW
<b>VESA-MT-PPC-EHL-SET</b>	VESA mount bracket set
<b>PANEL-MT-PPC-APL-SET</b>	Panel mount set with clamps and screws

# Ch. 2

## System Installation

[2.1 CPU Board Outline](#)

[2.2 Connector Summary](#)

[2.3 Connector Pin Assignments](#)

[2.4 External I/O Overview](#)

[2.5 External I/O Pin Assignment](#)

## 2.1 CPU Board Outline

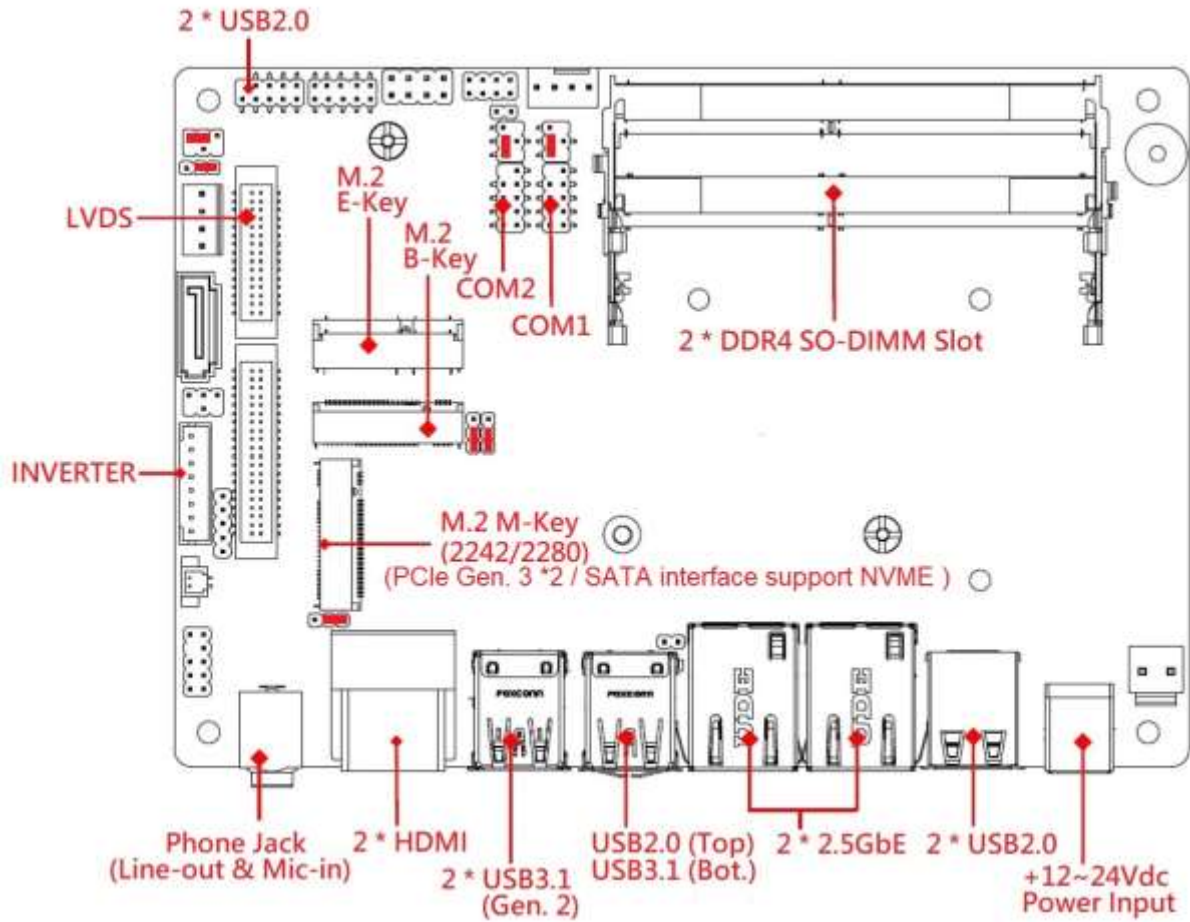

PPC EHL CPU Board

## 2.2 Connector Summary

Connector	Type of Connections	Pin #
DDR4 SO-DIMM Slot	External SO-DIMM Slot	260-pin
Power DC Jack	External Power DC Jack Connector	2-pin
2 * USB3.1 (Gen. 2)	External Dual USB3.1 Connector	18-pin
2* USB3.0	External Dual USB2.0 Connector	10-pin
2 * HDMI	External Dual HDMI Connector	38-pin
2 *2.5GbE	External Dual RJ45 Connector	16-pin
M.2 M-Key	External M.2 M-Key (2242/2280) PCIe Gen. 3 *2 / SATA interface support NVME	75-pin
M.2 E-Key	External M.2 E-Key	75-pin
M.2 B-Key	External M.2 B-Key	75-pin
<b>COM1</b> (RS232/422/485)	2.0mm 9-pin pin header	9-pin
<b>COM2</b> (RS232)	2.0mm 9-pin pin header	9-pin
USB2.0 x 2	2.0mm 9-pin pin header	9-pin
LVDS	1.25mm 30-pin box header	30-pin
INVERTER	2.0mm 8-pin box header	8-pin

## 2.3 Connector Pin Assignments

### Power DC Jack

Pin #	Signal Name
1	+12~24V Power Input
2	GND

### COM1 (RS232/422/485)

Pin #	Signal Name	Pin #	Signal Name
1	DCD1 /422TX- /RS485-	2	DSR1
3	RXD1 /422TX+ /RS485+	4	RTS1
5	TXD1/422RX+	6	CTS1
7	DTR1/422RX-	8	RI1
9	GND		

### COM2 (RS232)

Pin #	Signal Name	Pin #	Signal Name
1	DCD2	2	DSR2
3	RXD2	4	RTS2
5	TXD2	6	CTS2
7	DTR2	8	RI2
9	GND		

### USB2.0 x 2

Pin #	Signal Name	Pin #	Signal Name
1	VCC	2	VCC
3	USB2_D1-	4	USB2_D2-
5	USB2_D1+	6	USB2_D2+
7	GND	8	GND
		10	NC

### LVDS

Pin #	Signal Name	Pin #	Signal Name
1	LVDSB_D3-	2	LVDSB_D3+
3	LVDSB_CLK-	4	LVDSB_CLK+
5	LVDSB_D2-	6	LVDSB_D2+
7	LVDSB_D1-	8	LVDSB_D1+
9	LVDSB_D0-	10	LVDSB_D0+
11	NC/DDC_DAT	12	NC/DDC_CLK
13	GND	14	GND
15	GND	16	GND
17	LVDSA_D3+	18	LVDSA_D3-
19	LVDSA_CLK+	20	LVDSA_CLK-
21	LVDSA_D2+	22	LVDSA_D2-
23	LVDSA_D1+	24	LVDSA_D1-
25	LVDSA_D0+	26	LVDSA_D0-
27	LCD_VDD	28	LCD_VDD
29	LCD_VDD	30	LCD_VDD

### Inverter

Pin #	Signal Name
1	Backlight_Enable
2	Backlight_PWM
3	Backlight LED VCC
4	Backlight LED VCC
5	GND
6	GND
7	Backlight UP SW
8	Backlight DN SW

## 2.4 External I/O Overview

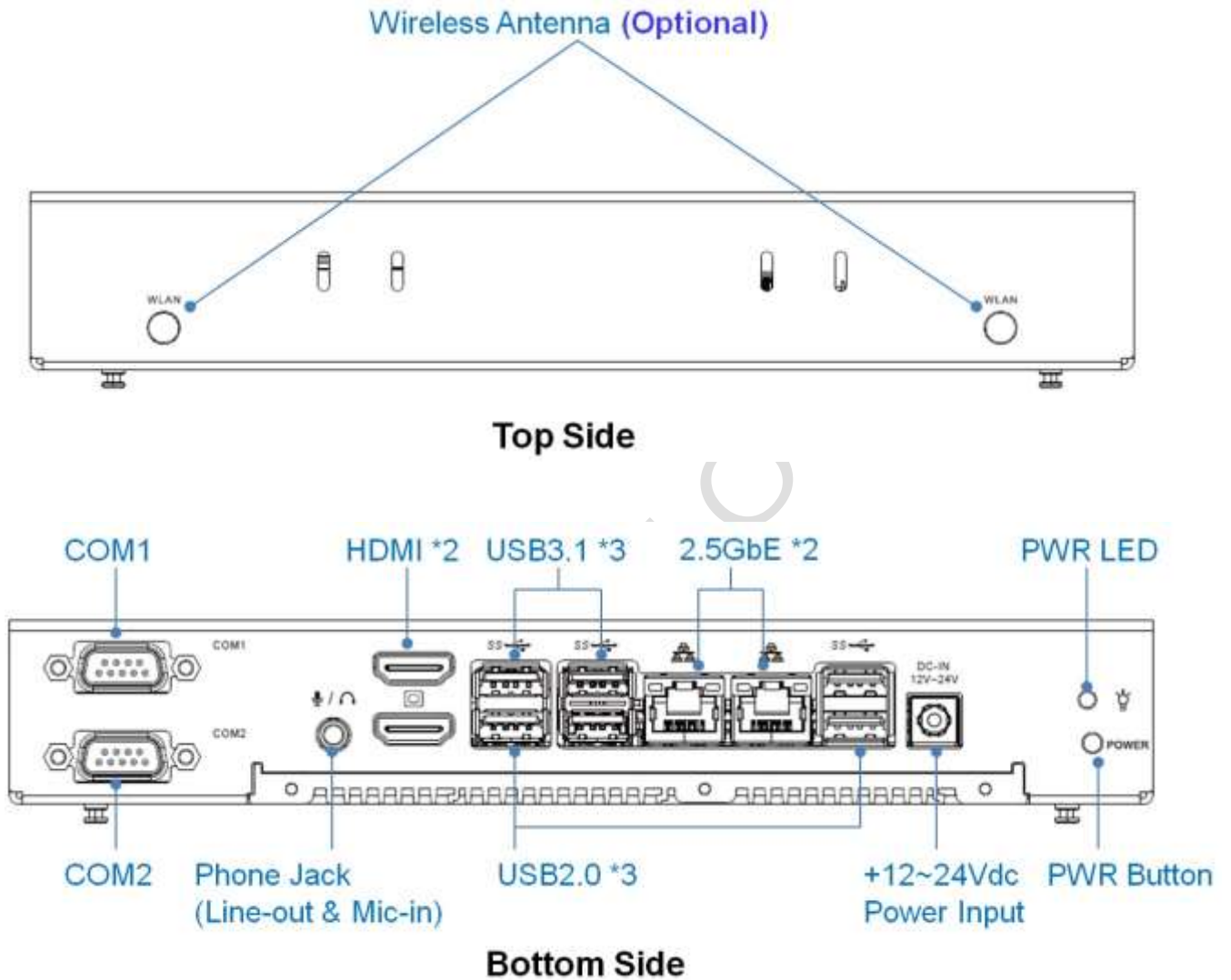

**NOTE:** COM1 RS232/422/485 is selected by BIOS setting. Please refer the section, 4.3 to set the function in the BIOS setup.

## 2.5 External I/O Pin Assignment

### Power DC Jack (+12~24Vdc Input)

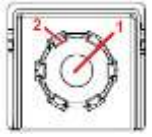
	Pin #	Signal Name
	1	+12~24Vdc
	2	GND

### COM1 (RS232/422/485)

(Change mode by BIOS Setup)

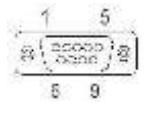
	Pin #	Signal Name	Pin #	Signal Name
	1	DCD1 /422TX- /RS485-	2	RXD1 /422TX+ /RS485+
	3	TXD1 /422RX+	4	DTR1 /422RX-
	5	GND	6	DSR1
	7	RTS1	8	CTS1
	9	RI1		

### COM2 (RS232)

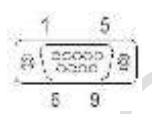
	Pin #	Signal Name	Pin #	Signal Name
	1	DCD2	2	RXD2
	3	TXD2	4	DTR2
	5	GND	6	DSR2
	7	RTS2	8	CTS2
9	RI2			

### 2.5 GbE

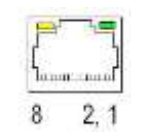
	Pin #	Signal Name	Pin #	Signal Name
	1	TP0+	2	TP0-
	3	TP1+	4	TP2+
	5	TP2-	6	TP1-
	7	TP3+	8	TP3-

### HDMI

	Pin #	Signal Name
	1	TMDS_Data2+
	2	TMDS_Data2_Shield
	3	TMDS_Data2-
	4	TMDS_Data1+
	5	TMDS_Data1_Shield
	6	TMDS_Data1-
	7	TMDS_Data0+
	8	TMDS_Data0_Shield
	9	TMDS_Data0-
	10	TMDS_CLK+
	11	TMDS_CLK_Shield
	12	TMDS_CLK-
	13	CEC
	14	Reserved
	15	SCL
	16	SDA
	17	DDC/CEC_GND
	18	+5V Power
19	Hop_Plug_Detect	

### USB2.0

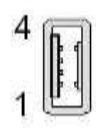
	Pin #	Signal Name
	1	VCC
	2	USB0-
	3	USB0+
4	GND	

### USB 3.1

	Pin #	Signal Name
	1	VCC
	2	D-
	3	D+
	4	GND
	5	SSRX-
	6	SSRX+
	7	GND
	8	SSTX-
	9	SSTX+



# Ch. 3

## Hardware Installation

PPC-150T-EHL supports various kinds of storages for industrial application, divided into M.2 2242 PCIe/SATA (M-Key).

[3.1 Installing the M.2 2242/2280 Storage](#)

[3.2 Installing the M.2 B-Key \(3024\) and M.2 M-Key \(2230\) Modules](#)

[3.3 Installing the Micro SIM Card \(Must have 3G/4G of M.2 B-Key \(3024\) Module in advance\)](#)

## 3.1 Installing the M.2 M-key (2242/2280) Storage

PPC-150T-EHL series support M.2 M-key (2242/2280) PCIe Gen. 3 \*2 / SATA interface NVME. Please refer the below instructions.

### [STEP]

1. Remove the 16 screws in a diagonal pattern as the image below.



2. Pull up rear cover carefully, which LCD, Backlight and Touch cables inside the rear cover and please be careful to open it.



- Support M.2 2240/2280 storage, which the green area is for 2242 and red area is for 2280.



- For 2242 or 2280 storage, please use a M2 screw driver to remove the top screw in advance, and then use M4 screw driver to move the bottom screw to the correct position.

(For example, The below figures show moving the screw for M.2 2242 storage.)



- Plug the M.2 storage in the slot and lock it up.



- Take the rear cover back and lock 16 screws.

**ICOP offers the standard M2. 2242 SATA storage as below.**

**[SPEC]**

Standard M.2 2242 form factor  
22 x 42 x 3.2 mm



**[M.2 2242 SATA LIST]**

<b>P/N</b>	<b>Flash Type</b>	<b>Capacity</b>	<b>Operating Temperature</b>
IM242S-64G-M	<b>MLC</b>	64GB	0°C ~ +70°C
IM242S-128G-M	<b>MLC</b>	128GB	0°C ~ +70°C
IM242S-256G-M	<b>MLC</b>	256GB	0°C ~ +70°C
IM242S-128G-T	<b>TLC</b>	128GB	0°C ~ +70°C
IM242S-256G-T	<b>TLC</b>	256GB	0°C ~ +70°C
IM242S-512G-T	<b>TLC</b>	512GB	0°C ~ +70°C
IM242S-1T-T	<b>TLC</b>	1TB	0°C ~ +70°C

## 3.2 Installing the M.2 B-Key (3024) and M.2 E-Key (2230) Modules

PPC-150T-EHL series support M.2 B-key (3024) USB3.1/USB2.0 interface and M.2 E-key (2230) USB2.0/PCIe Gen3 \*1 interface. Please refer the below instructions.

### [STEP]

1. Remove the 16 screws in a diagonal pattern as the image below.



2. Pull up rear cover carefully, which LCD, Backlight and Touch cables inside the rear cover and please be careful to open it.



3. Remove the screw and plug the M.2 B-Key (3024) and M.2 E-Key (2230) modules on the slots, and then lock them up.



4. Take the rear cover back and lock 16 screws.

### 3.3 Installing the Micro SIM Card (Must have 3G/4G of M.2 B-key (3024) Module in advance)

PPC-150T-EHL series support Micro SIM Card for 3G/4G of M.2 B-key (3024) USB3.1/USB2.0 module

#### [STEP]

1. Please refer the section, 3.2 to install 3G/4G of M.2 B-key (3024) Module in advance.
2. Plug Micro SIM Card on the slot.

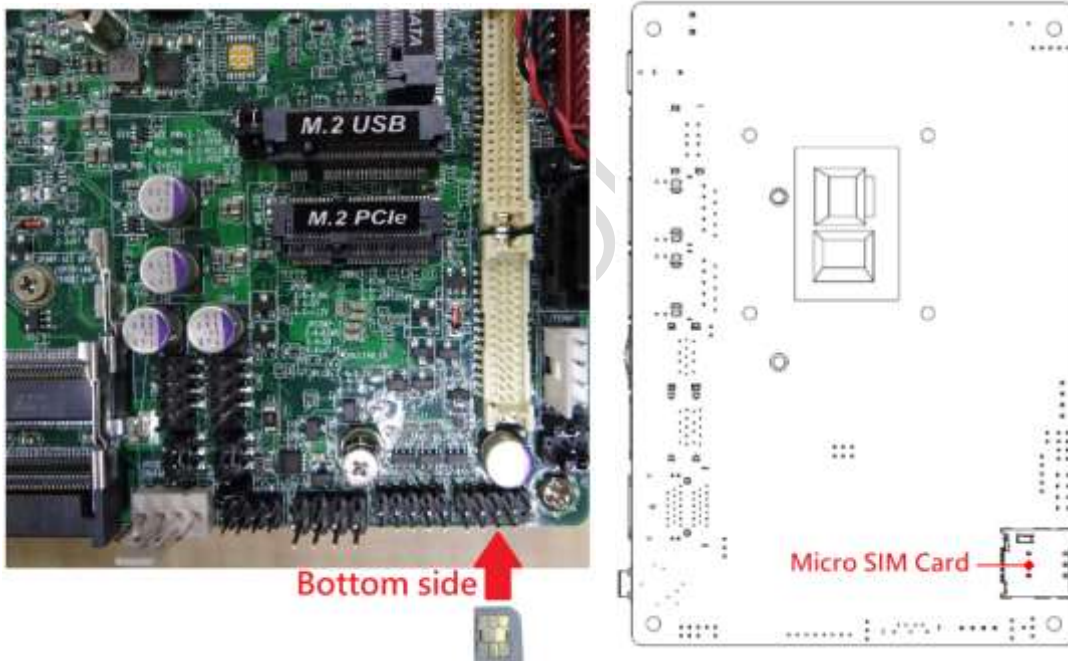

# Ch. 4

## Drivers and BIOS Instruction

[4.1 Operating System Support and Drivers](#)

[4.2 BIOS Hot Key](#)

[4.3 BIOS COM1 Setting \(RS232/RS422/RS485\)](#)

[4.4 BIOS COM2 Setting \(Change Settings\)](#)

[4.5 BIOS AT Mode Setting \(Support Auto-Power On Function\)](#)

[4.6 BIOS Serial Port Console Redirection](#)

[4.7 BIOS Load Default Setting](#)



## 4.1 Operating System Support and Drivers

The PPC-150T-EHL provides the Win10 and Win11 drivers.

Please get the drivers from ICOP technical support URL:

[https://www.icop.com.tw/resource\\_entrance](https://www.icop.com.tw/resource_entrance)

For Linux, most Linux distributions support Intel® Elkhart Lake Processor and user can install Linux upon PPC-150T-EHL directly. Please contact your region sales for technical support if you have any question.

ICOP TECHNOLOGY INC.

## 4.2 BIOS Hot Key

After power on, it supports BIOS hot key as below.

---



Press < **Del** > to enter the AMI BIOS setup

---



Press < **F7** > to enter Popup Menu

---

ICOP TECHNOLOGY INC.

## 4.3 BIOS COM1 Setting (RS232/422/485)

COM1 can be set to be RS232/422/485 function. Please refer the instruction as below.

(1) In the BIOS Setup, please go to “Advanced” and “Super IO Configuration”.

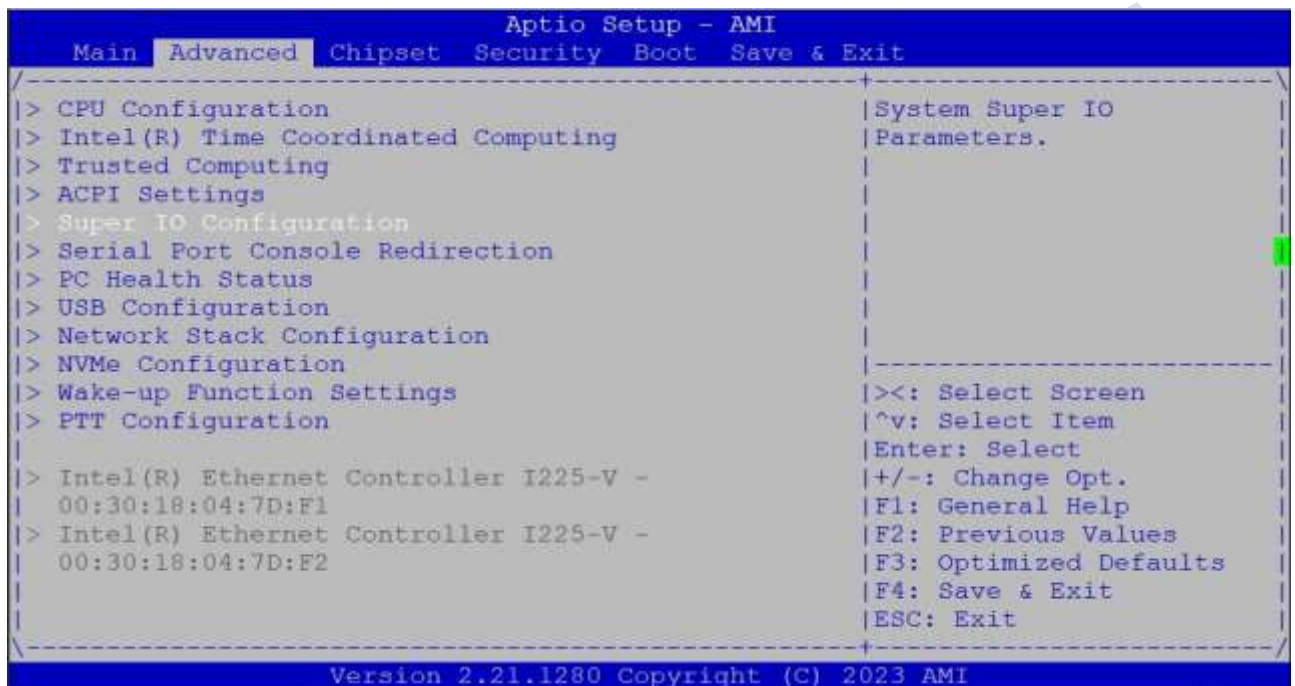

(2) Go to “Serial Port 1 Configuration”.

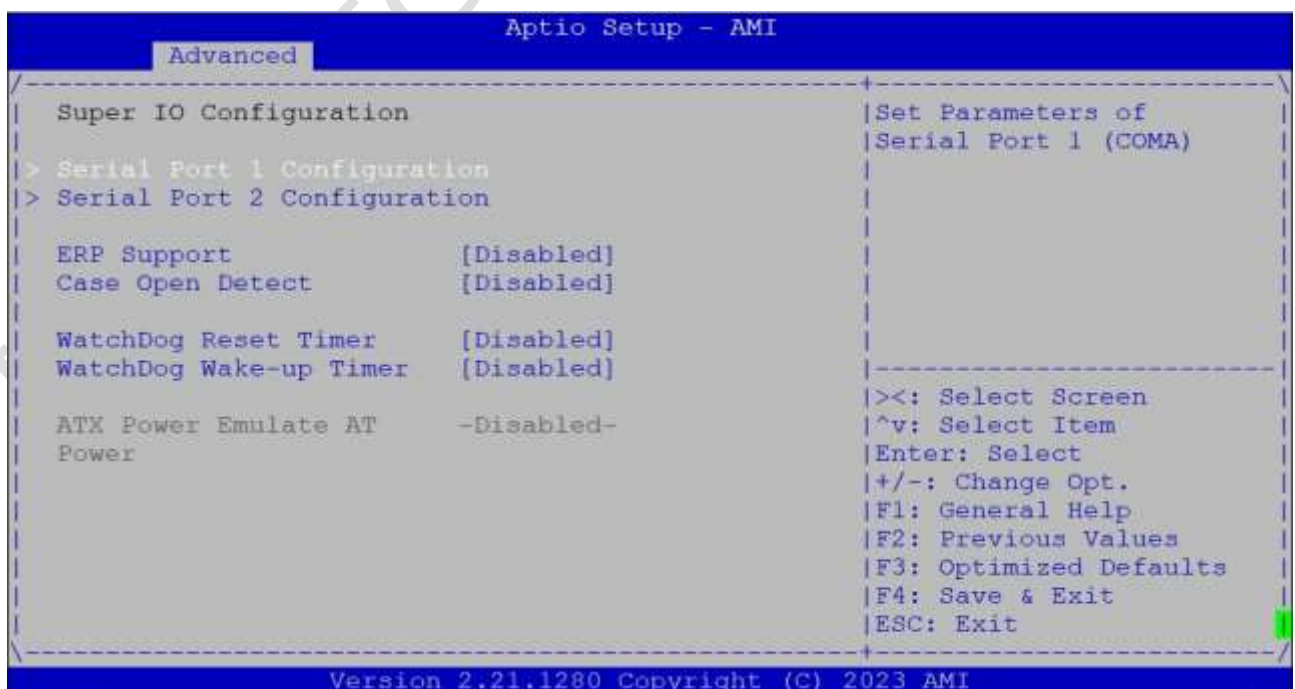

(3) Go to Transmission Mode and set RS232/422/485 function.

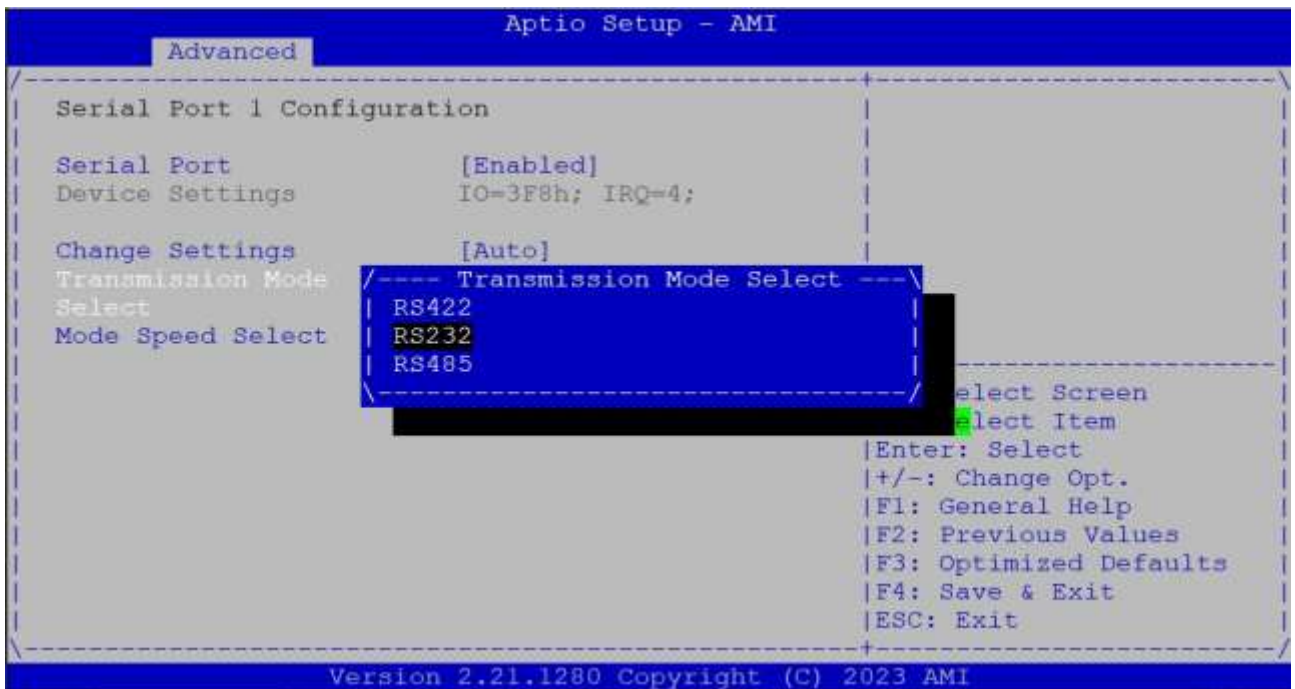

(4) After setting, please press "F4" key to save & exit.

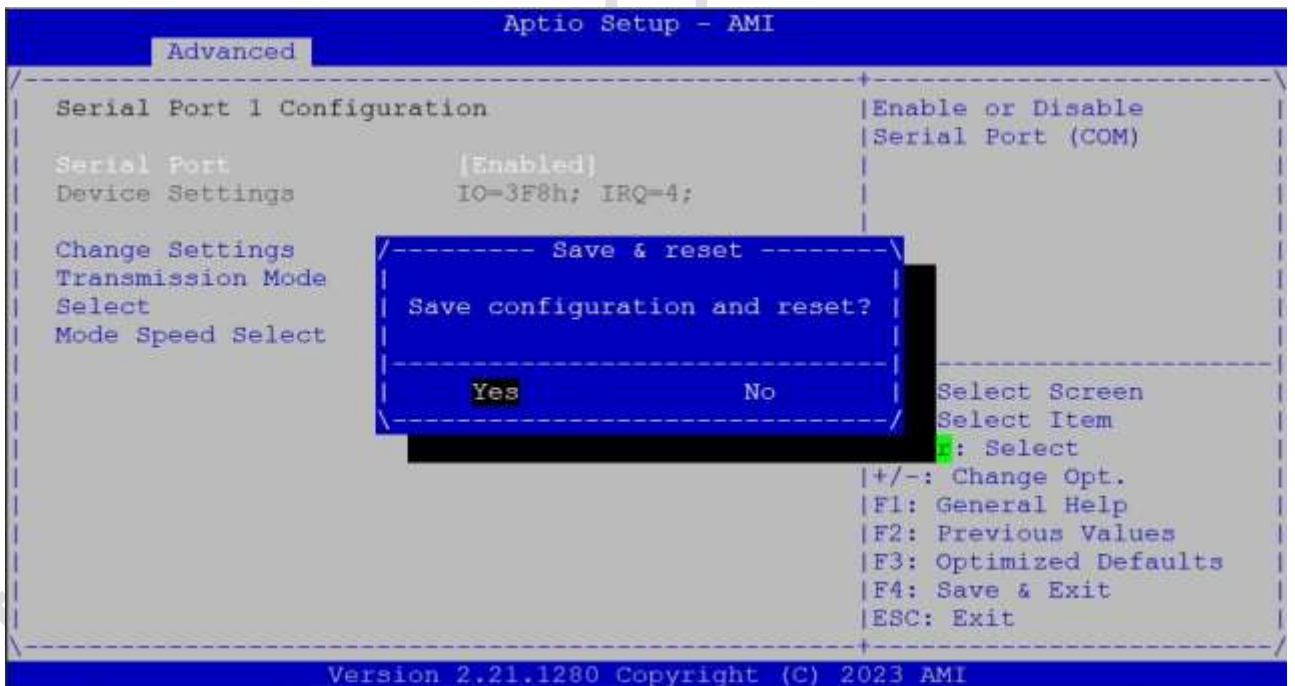

## 4.4 BIOS COM2 Setting (Change Settings)

COM2 can be changed settings as below.

(1) In the BIOS Setup, please go to “Advanced” and “Super IO Configuration”.

```
Aptio Setup - AMI
Main  Advanced  Chipset  Security  Boot  Save & Exit
-----
|> CPU Configuration
|> Intel(R) Time Coordinated Computing
|> Trusted Computing
|> ACPI Settings
|> Super IO Configuration
|> Serial Port Console Redirection
|> PC Health Status
|> USB Configuration
|> Network Stack Configuration
|> NVMe Configuration
|> Wake-up Function Settings
|> PTT Configuration
-----
|> Intel(R) Ethernet Controller I225-V -
| 00:30:18:04:7D:F1
|> Intel(R) Ethernet Controller I225-V -
| 00:30:18:04:7D:F2
-----
|<<: Select Screen
|^v: Select Item
|Enter: Select
|+/-: Change Opt.
|F1: General Help
|F2: Previous Values
|F3: Optimized Defaults
|F4: Save & Exit
|ESC: Exit
-----
Version 2.21.1280 Copyright (C) 2023 AMI
```

(2) Go to “Serial Port 2 Configuration”.

```
Aptio Setup - AMI
Advanced
-----
| Super IO Configuration
| Set Parameters of
| Serial Port 2 (COMB)
-----
|> Serial Port 1 Configuration
|> Serial Port 2 Configuration
-----
| ERP Support [Disabled]
| Case Open Detect [Disabled]
-----
| WatchDog Reset Timer [Disabled]
| WatchDog Wake-up Timer [Disabled]
-----
| ATX Power Emulate AT -Disabled-
| Power
-----
|<<: Select Screen
|^v: Select Item
|Enter: Select
|+/-: Change Opt.
|F1: General Help
|F2: Previous Values
|F3: Optimized Defaults
|F4: Save & Exit
|ESC: Exit
-----
Version 2.21.1280 Copyright (C) 2023 AMI
```

(3) Go to “Change Settings” and set IO address and IRQ if you want.

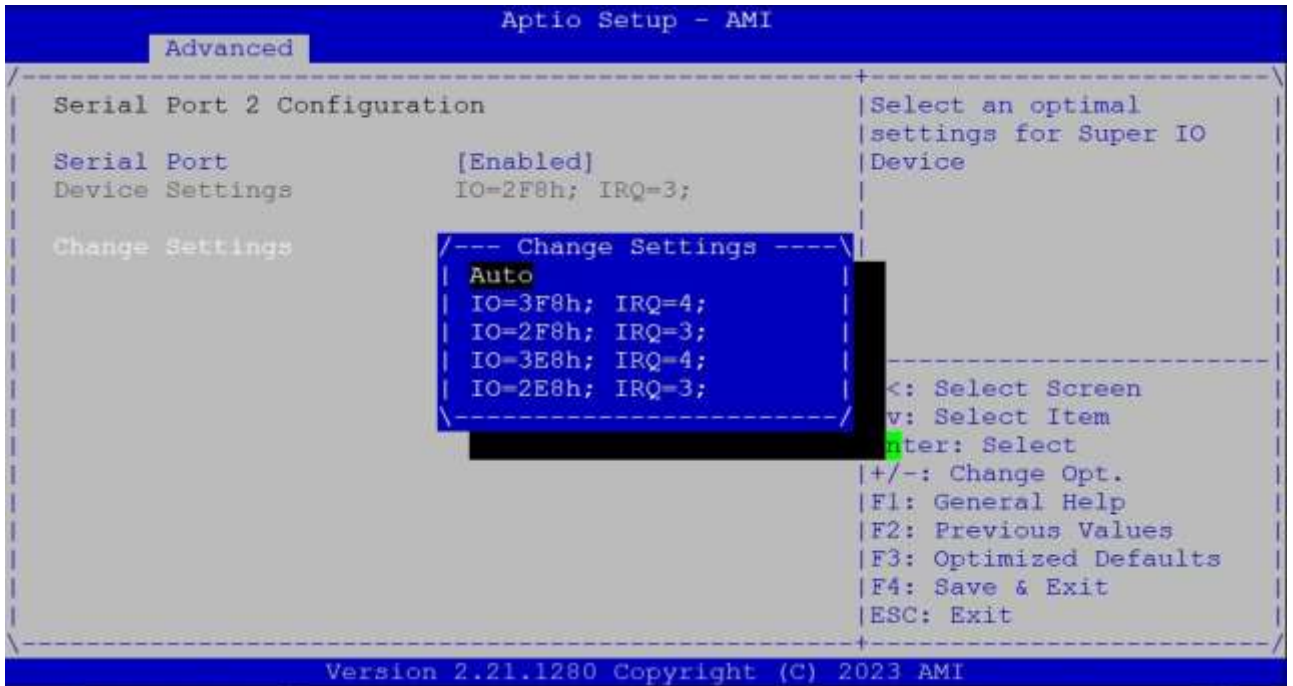

(4) After setting, please press “F4” key to save & exit.

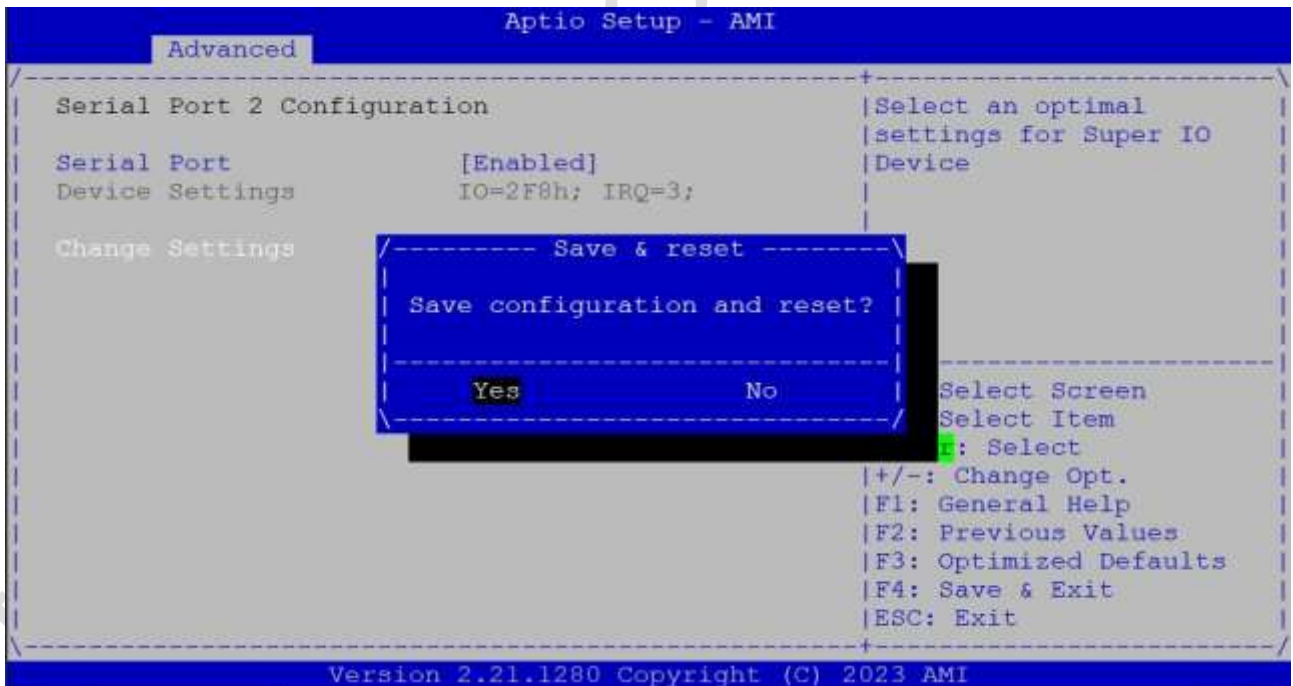

## 4.5 BIOS AT Mode Setting (Support Auto-Power On Function)

PPC-150T-EHL supports “Auto-Power On function”, user doesn’t need to press “power button” for system power on and just needs to plug power source input and system will be power on automatically.

(1) In the BIOS Setup, please go to “Chipset” and “PCH-IO Configuration”.

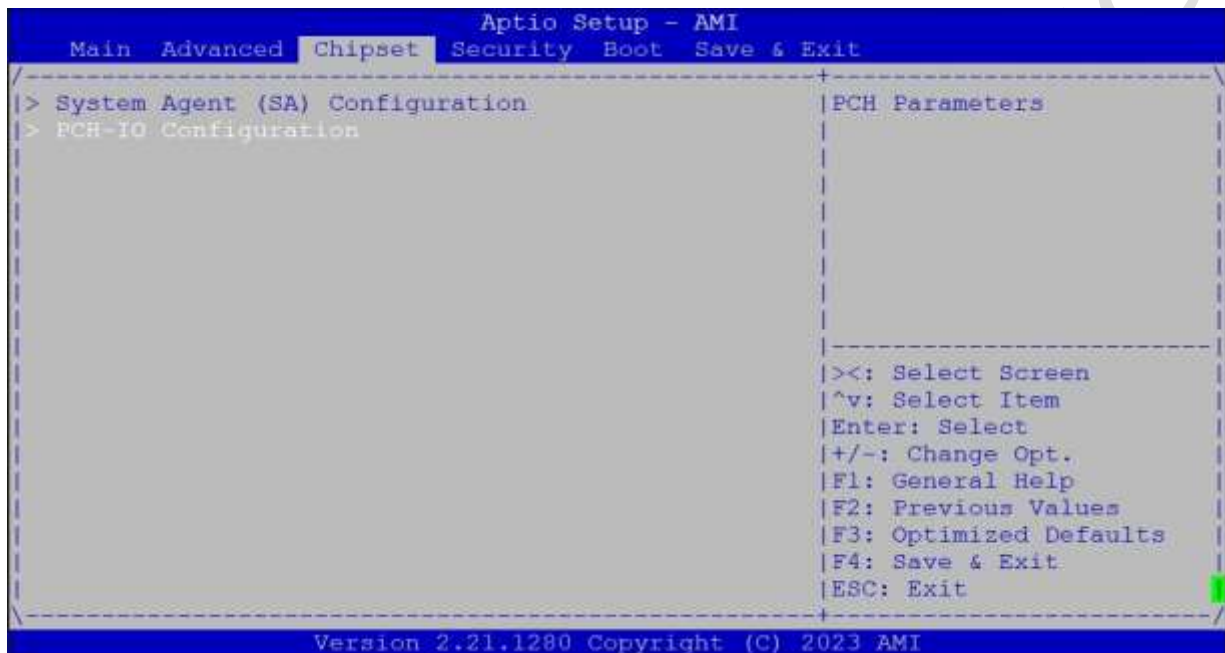

(2) Set “System State after Power Failure” to be “Always On”.

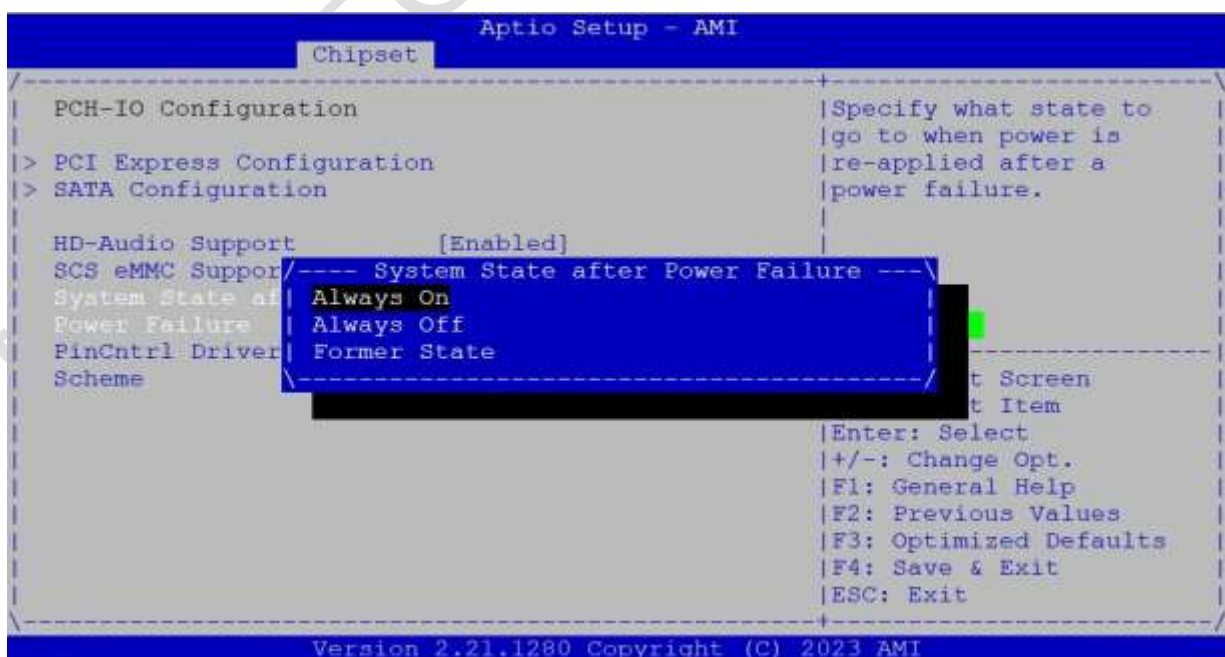

(3) After setting, please press “F4” key to save & exit.

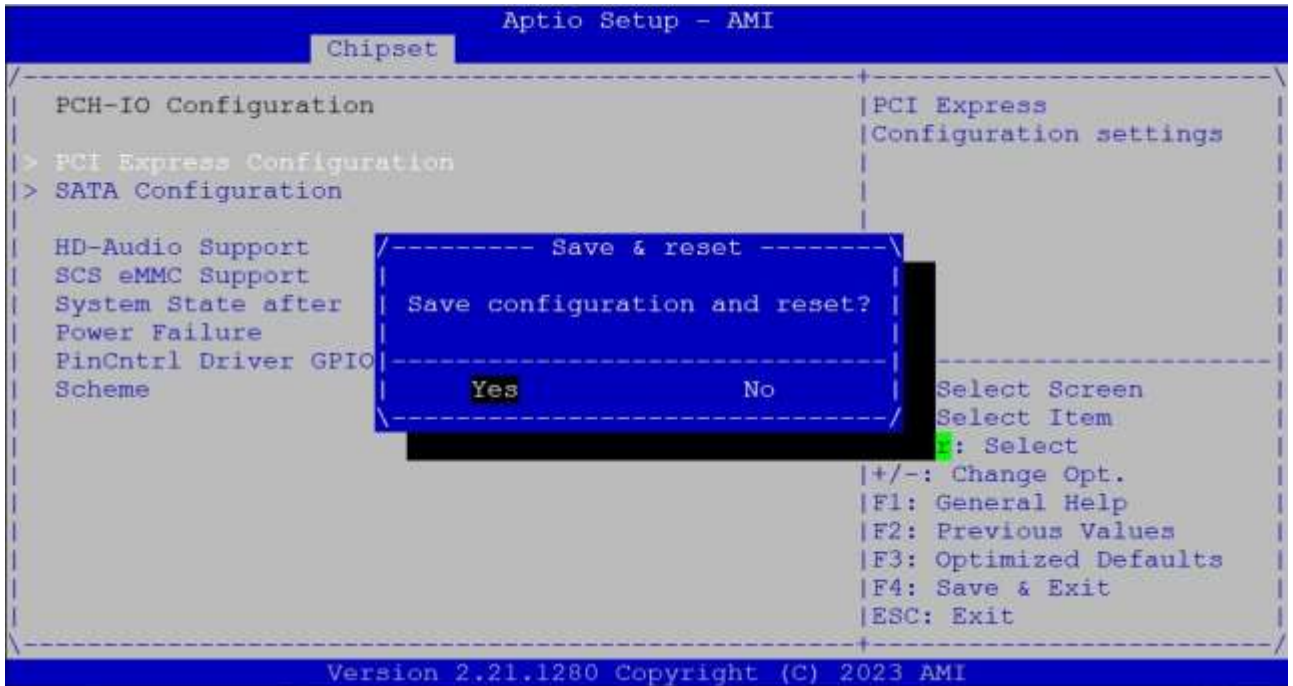

**Note:**

After system shut down by operating system, PPC-150T-EHL will be power-off. For next booting up, user just needs to re-plug power adapter or power reset again, while system will be boot-up automatically.



## 4.6 BIOS Serial Port Console Redirection

PPC-150T-EHL supports Serial Port Console Redirection as below.

(1) Go to “Advanced” and “Serial Port Console Redirection”.

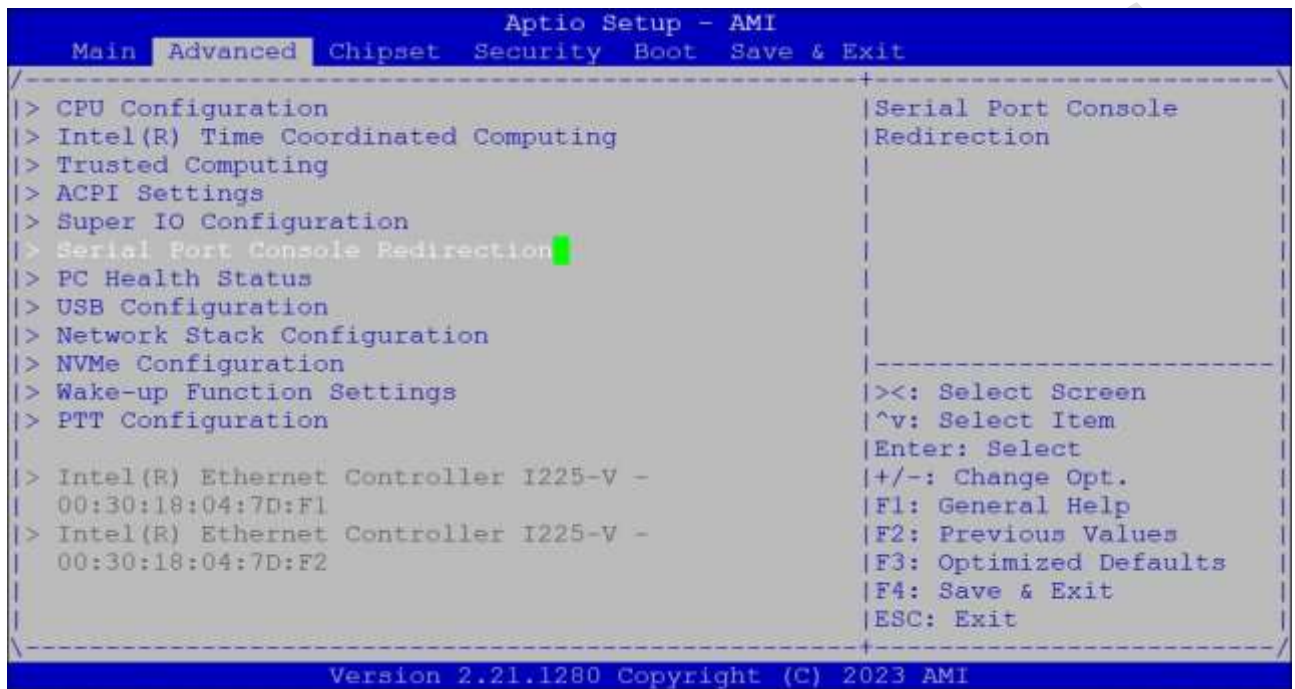

(2) Set “Console Redirection” to be “Enabled”.

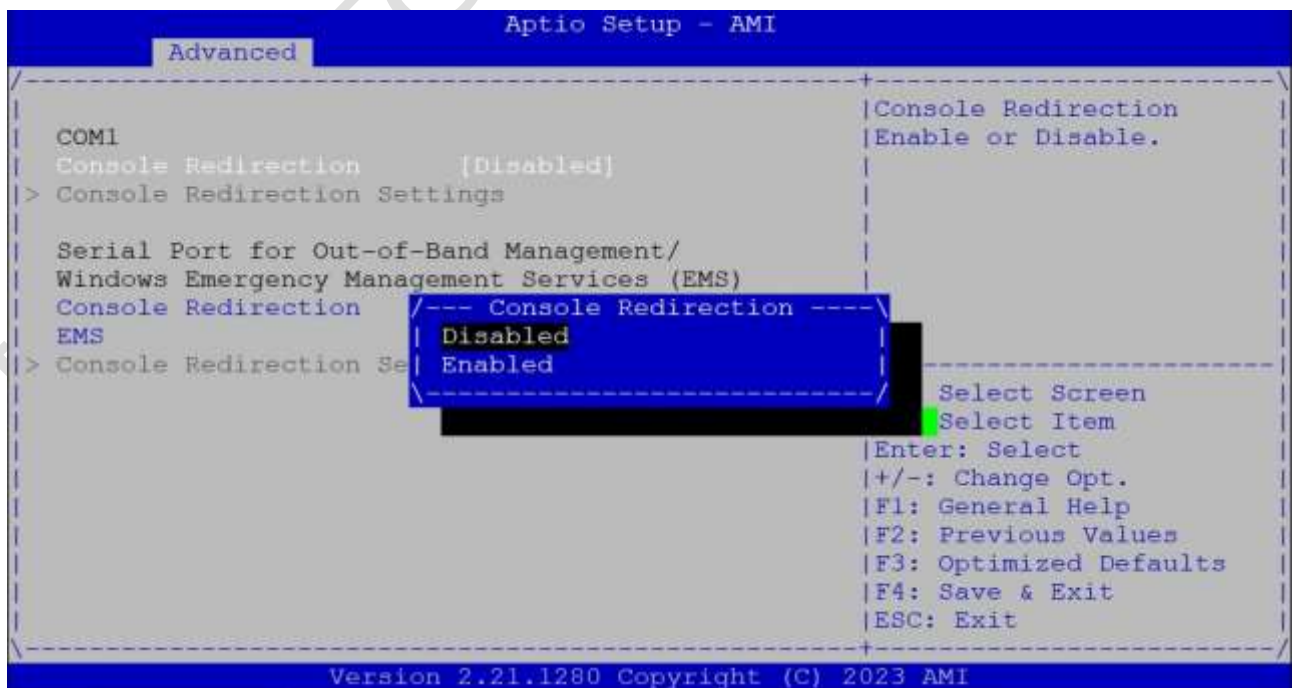

(3) Go to “Console Redirection Settings”.

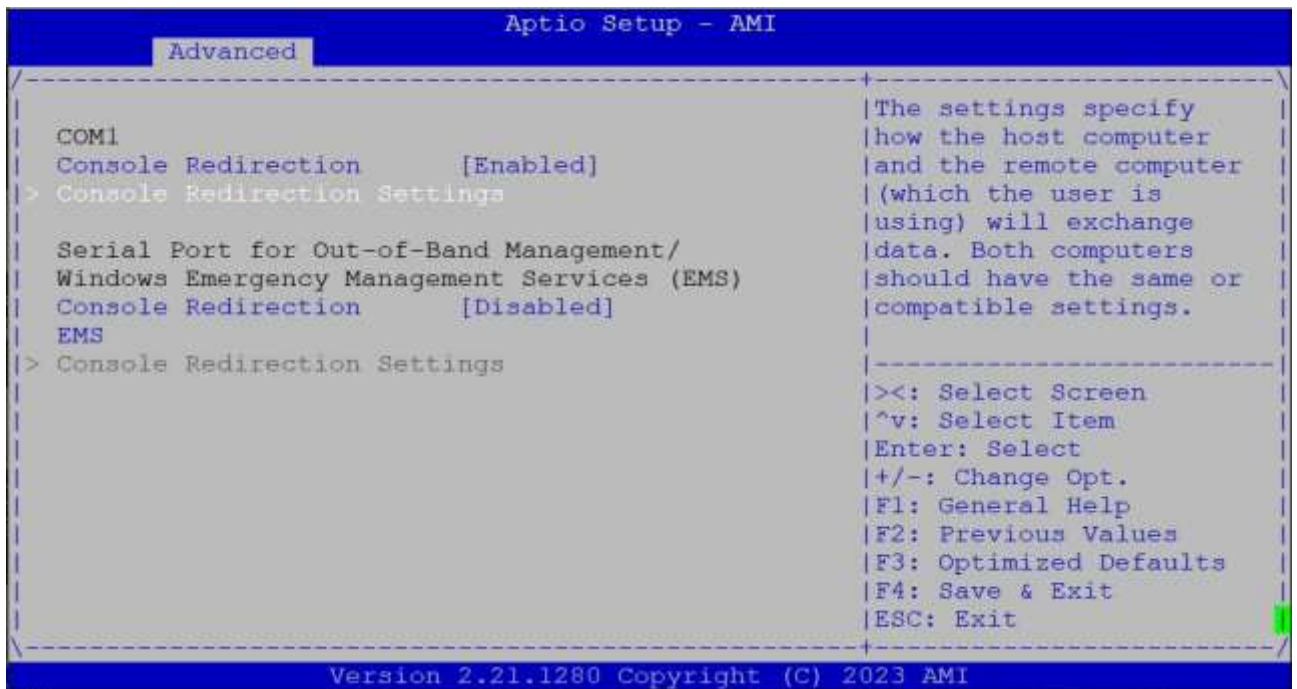

(4) Set “Terminal Type” to “VT100+”.

Emulation: [ANSI]: Extended ASCII char set; [VT100]: ASCII char set;

[VT100+]: Extended VT100 to support color, function keys, etc.;

[VT-UTF8]: Uses UTF8 encoding to map Unicode chars onto 1 or more Bytes.

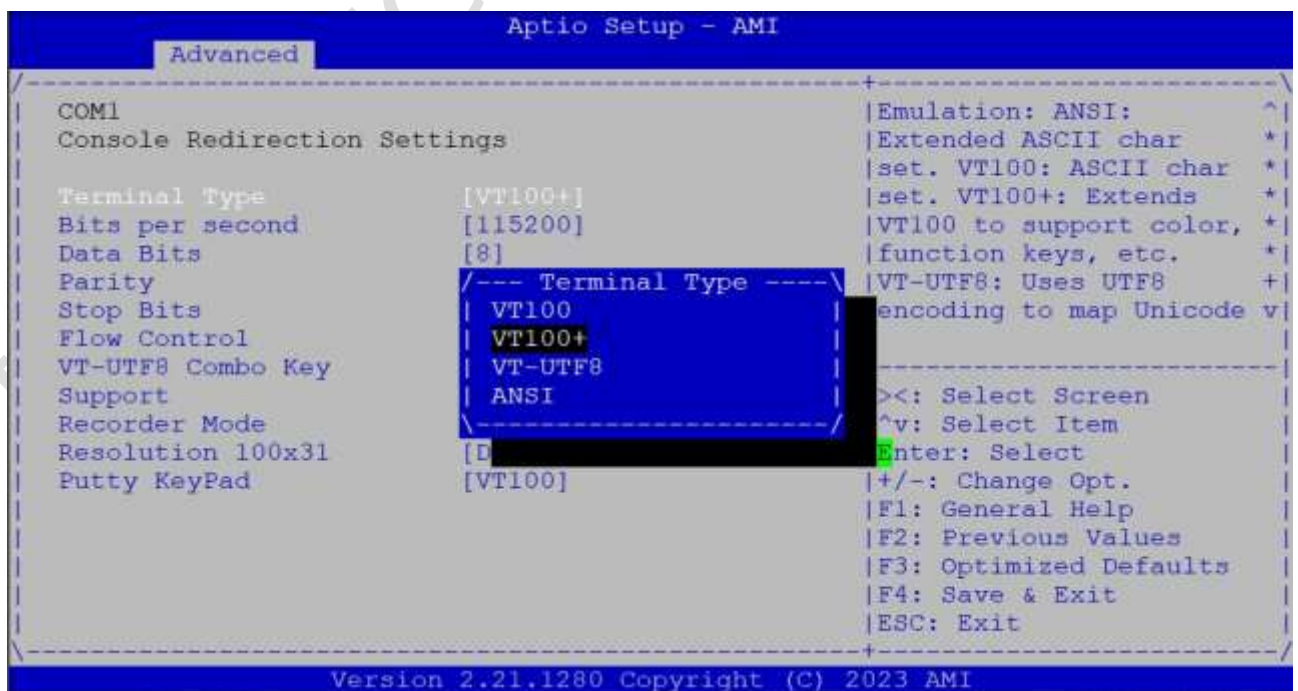

(4) After setting, please press “F4” key to save & exit.

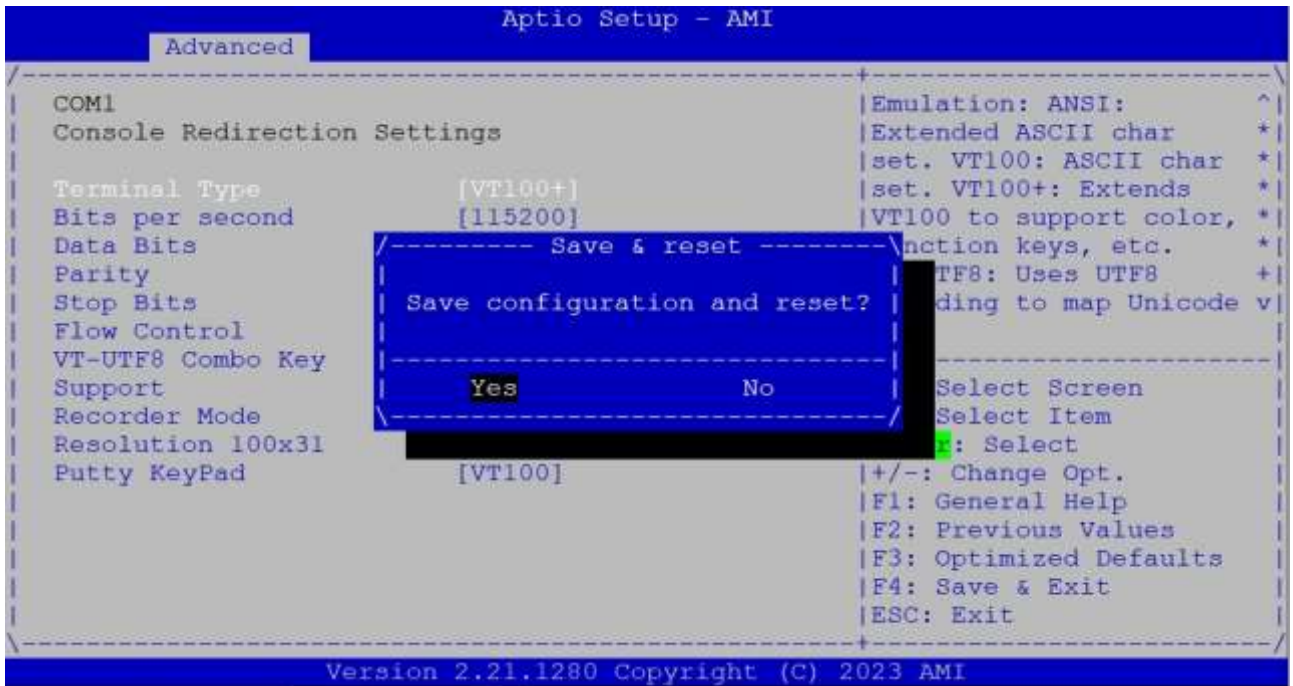

## 4.7 BIOS Load Default Setting

(1) Press “F3” key to load optimized defaults.

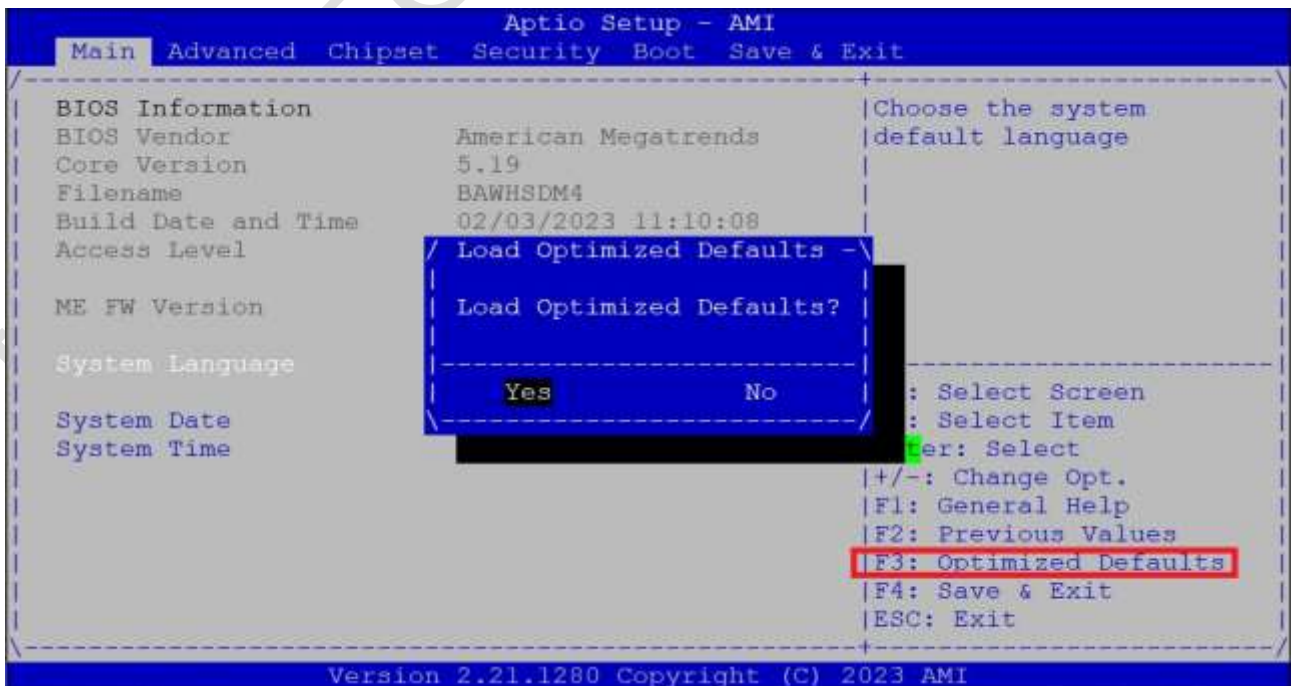

(2) After setting, please press “F4” key to save & exit.

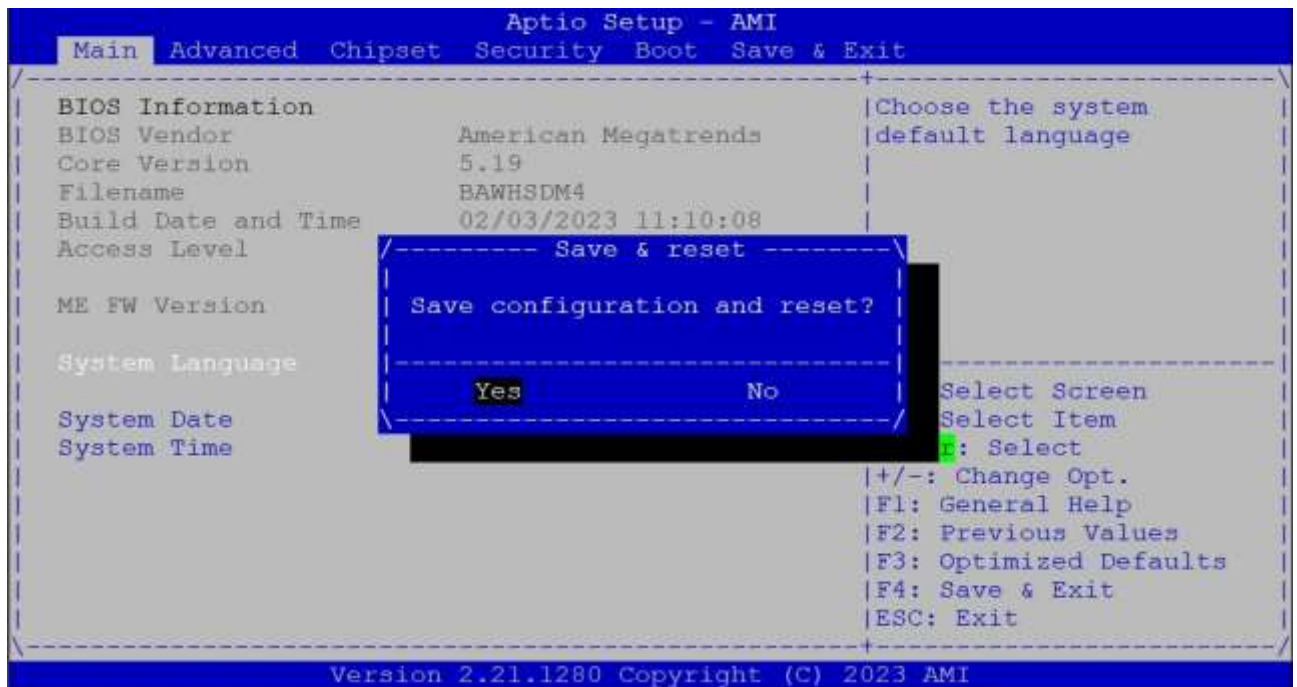

# Warranty

This product is warranted to be in good working order for a period of one year from the date of purchase. Should this product fail to be in good working order at any time during this period, we will, at our option, replace or repair it at no additional charge except as set forth in the following terms. This warranty does not apply to products damaged by misuse, modifications, accident or disaster. Vendor assumes no liability for any damages, lost profits, lost savings or any other incidental or consequential damage resulting from the use, misuse of, originality to use this product. Vendor will not be liable for any claim made by any other related party. Return authorization must be obtained from the vendor before returned merchandise will be accepted. Authorization can be obtained by calling or faxing the vendor and requesting a Return Merchandise Authorization (RMA) number. Returned goods should always be accompanied by a clear problem description.

All Trademarks appearing in this manuscript are registered trademark of their respective owners. All Specifications are subject to change without notice.  
©ICOP Technology Inc. 2024