

# mITX-1505A (MRZNRMI)

---

Mini-ITX Motherboard  
User's Manual 1st Ed (Rev 1.0)

## Copyright Notice

---

This document is copyrighted, 2022. All rights are reserved. The original manufacturer reserves the right to make improvements to the products described in this manual at any time without notice.

No part of this manual may be reproduced, copied, translated, or transmitted in any form or by any means without the prior written permission of the original manufacturer. Information provided in this manual is intended to be accurate and reliable. However, the original manufacturer assumes no responsibility for its use, or for any infringements upon the rights of third parties that may result from its use.

The material in this document is for product information only and is subject to change without notice. While reasonable efforts have been made in the preparation of this document to assure its accuracy, GIGAIPC assumes no liabilities resulting from errors or omissions in this document, or from the use of the information contained herein.

GIGAIPC reserves the right to make changes in the product design without notice to its users.

## Acknowledgement

---

All other products' name or trademarks are properties of their respective owners.

- AMD® is trademark of Advanced Micro Devices.
- Microsoft Windows is a registered trademark of Microsoft Corp.
- ITE is a trademark of Integrated Technology Express, Inc.
- IBM, PC/AT, PS/2, and VGA are trademarks of International Business Machines Corporation.

All other product names or trademarks are properties of their respective owners.

## Packing List

---

Before setting up your product, please make sure the following items have been shipped:

Item	Quantity
mITX-1505A MB	1
SATA power cable	1
I/O Shield	1
Gasket for HDMI connector *	2

If any of these items are missing or damaged, please contact your distributor or sales representative immediately.

\* HDMI Gasket assemble :

Stick 1 Gasket between 2 HDMI connectors (as below).

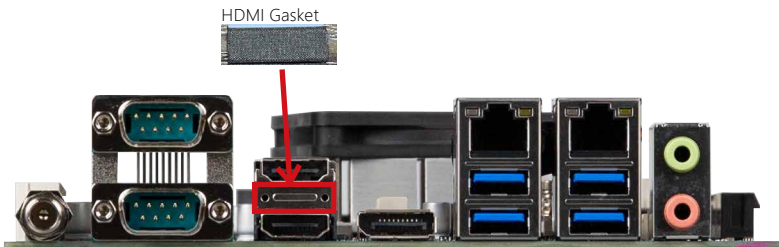

## About this Document

---

This User's Manual contains all the essential information, such as detailed descriptions and explanations on the product's hardware and software features (if any), its specifications, dimensions, jumper/connector settings/definitions, and driver installation instructions (if any), to facilitate users in setting up their product.

Users may refer to the [GIGAIPC.com](http://GIGAIPC.com) for the latest version of this document.

## Safety Precautions

---

Please read the following safety instructions carefully. It is advised that you keep this manual for future references

1. All cautions and warnings on the device should be noted.
2. Make sure the power source matches the power rating of the device.
3. Position the power cord so that people cannot step on it. Do not place anything over the power cord.
4. Always completely disconnect the power before working on the system's hardware.
5. No connections should be made when the system is powered as a sudden rush of power may damage sensitive electronic components.
6. If the device is not to be used for a long time, disconnect it from the power supply to avoid damage by transient over-voltage.
7. Always disconnect this device from any AC supply before cleaning.
8. While cleaning, use a damp cloth instead of liquid or spray detergents.
9. Make sure the device is installed near a power outlet and is easily accessible.
10. Keep this device away from humidity.
11. Place the device on a solid surface during installation to prevent falls
12. Do not cover the openings on the device to ensure optimal heat dissipation.

13. Watch out for high temperatures when the system is running.
14. Do not touch the heat sink or heat spreader when the system is running
15. Never pour any liquid into the openings. This could cause fire or electric shock.
16. As most electronic components are sensitive to static electrical charge, be sure to ground yourself to prevent static charge when installing the internal components. Use a grounding wrist strap and contain all electronic components in any static-shielded containers.
17. If any of the following situations arises, please the contact our service personnel:
  - i. Damaged power cord or plug
  - ii. Liquid intrusion to the device
  - iii. Exposure to moisture
  - iv. Device is not working as expected or in a manner as described in this manual
  - v. The device is dropped or damaged
  - vi. Any obvious signs of damage displayed on the device
- 18. DO NOT LEAVE THIS DEVICE IN AN UNCONTROLLED ENVIRONMENT WITH TEMPERATURES BEYOND THE DEVICE'S PERMITTED STORAGE TEMPERATURES (SEE CHAPTER 1) TO PREVENT DAMAGE.**

## FCC Statement

---

### **Warning!**



This device complies with Part 15 FCC Rules. Operation is subject to the following two conditions: (1) this device may not cause harmful interference, and (2) this device must accept any interference received including interference that may cause undesired operation.

### **Caution:**

*There is a danger of explosion if the battery is incorrectly replaced. Replace only with the same or equivalent type recommended by the manufacturer. Dispose of used batteries according to the manufacturer's instructions and your local government's recycling or disposal directives.*

### **Attention:**

*Il y a un risque d'explosion si la batterie est remplacée de façon incorrecte. Ne la remplacer qu'avec le même modèle ou équivalent recommandé par le constructeur. Recycler les batteries usées en accord avec les instructions du fabricant et les directives gouvernementales de recyclage.*



## China RoHS Requirements (CN)

产品中有毒有害物质或元素名称及含量

GIGAIPC Main Board/ Daughter Board/ Backplane

部件名称	有毒有害物质或元素					
	铅 (Pb)	汞 (Hg)	镉 (Cd)	六价铬 (Cr(VI))	多溴联苯 (PBB)	多溴二苯醚 (PBDE)
印刷电路板 及其电 子组件	○	○	○	○	○	○
外部信号 连接器 及线材	○	○	○	○	○	○
<p>○: 表示该有毒有害物质在该部件所有均质材料中的含量均在 SJ/T 11363-2006 标准规定的限量要求以下。</p> <p>X: 表示该有毒有害物质至少在该部件的某一均质材料中的含量超出 SJ/T 11363-2006 标准规定的限量要求。</p> <p>备注: 此产品所标示之环保使用期限, 系指在一般正常使用状况下。</p>						

# China RoHS Requirement (EN)

## Poisonous or Hazardous Substances or Elements in Products GIGAIPC Main Board/ Daughter Board/ Backplane

Component	Poisonous or Hazardous Substances or Elements					
	Lead (Pb)	Mercury (Hg)	Cadmium (Cd)	Hexavalent Chromium (Cr(VI))	Polybrominated Biphenyls (PBB)	Polybrominated Diphenyl Ethers (PBDE)
PCB & Other Components	○	○	○	○	○	○
Wires & Connectors for External Connections	○	○	○	○	○	○
<p>○ : The quantity of poisonous or hazardous substances or elements found in each of the component's parts is below the SJ/T 11363-2006-stipulated requirement.</p> <p>X: The quantity of poisonous or hazardous substances or elements found in at least one of the component's parts is beyond the SJ/T 11363-2006-stipulated requirement.</p> <p>Note: The Environment Friendly Use Period as labeled on this product is applicable under normal usage only</p>						

## Table Contents

<b>Mini-ITX Motherboard</b>	<b>1</b>
<b>User's Manual 1st Ed (Rev 1.0)</b>	
Copyright Notice .....	2
Acknowledgement .....	3
Packing List.....	4
About this Document .....	5
Safety Precautions .....	6
FCC Statement.....	8
China RoHS Requirements (CN).....	9
China RoHS Requirement (EN) .....	10
<b>Chapter 1 – Product Specifications</b>	<b>14</b>
1.1 Specifications .....	16
<b>Chapter 2 – Hardware Information</b>	<b>18</b>
2.1 Jumpers and Connectors .....	19
2.2.1 IO Connector Information.....	22
2.2.2 DC_IN1 (DC IN Jack connector).....	23
2.2.3 COM1_2 (COM Port (RS-232)) .....	24
2.2.4 HDMI_21 (HDMI connector).....	25
2.2.5 DP (Display port) .....	26
2.2.6 USB3_LAN1, USB3_LAN2 (USB+LAN connector x 2).....	27
2.2.7 DC_IN2 (ATX 2x2 pin power connector).....	28
2.2.8 SYS_FAN (System Fan connector) .....	29
2.2.9 SATAPW0, SATAPW1 (SATA power connector) .....	30

2.2.10	SATA0, SATA1 (SATA 6Gb/s Connector) .....	31
2.2.11	F_USB2_1, F_USB2_2 (USB 2.0 header) .....	32
2.2.12	COM3, COM4, COM5 (COM header (RS-232)).....	33
2.2.13	GPIO_CNT(General purpose input/output connector)	34
2.2.14	CCTALK (ccTalk header) .....	35
2.2.15	CC_PWR (ccTalk power jumper).....	36
2.2.16	SYS_PANEL (Front Panel Header).....	37
2.2.17	TPM_LPC (TPM header).....	38
2.2.18	CI (Chassis Intrusion detect header) .....	39
2.2.19	AT_CN (AT/ATX mode select jumper) .....	40
2.2.20	SODIMM1, SODIMM2 (2 x DDR4 SO-DIMM slots).....	41
2.2.21	CPU_FAN (CPU Fan connector).....	42
2.2.22	PCIEX4 (PCIe x16 (Gen3 x4) slot) .....	43
2.2.23	M2M (M.2 Slot, M-key NGFF 2280) .....	44
2.2.24	SPK_OUT (Speaker out connector) .....	45
2.2.25	F_AUDIO (Front panel audio header).....	46
2.2.26	BAT (Battery connector) .....	47
2.2.27	M2E (M.2 Slot, E-key NGFF 2230) .....	48
2.2.28	CLR_CMOS (Clear CMOS jumper) .....	49
2.2.29	MPCIE (Mini PCIe connector).....	50

## Chapter 3 – BIOS 51

3.1	Introduction .....	52
3.2	The Main Menu.....	53
3.3	Advanced .....	54
3.3.1	TPM Configuration.....	55

3.3.2	IT8786 Super IO Configuration .....	56
3.3.3	Hardware Monitor .....	57
3.3.4	CPU Configuration .....	58
3.3.5	Network Stack Configuration.....	59
3.3.6	S5 RTC Wake Settings .....	60
3.3.7	SATA Configuration .....	61
3.3.8	Digital IO Port Configuration .....	62
3.4	Chipset .....	63
3.5	Security .....	64
3.6	Boot.....	67
3.7	Save & Exit .....	68

# Chapter 1

---

## Chapter 1 – Product Specifications

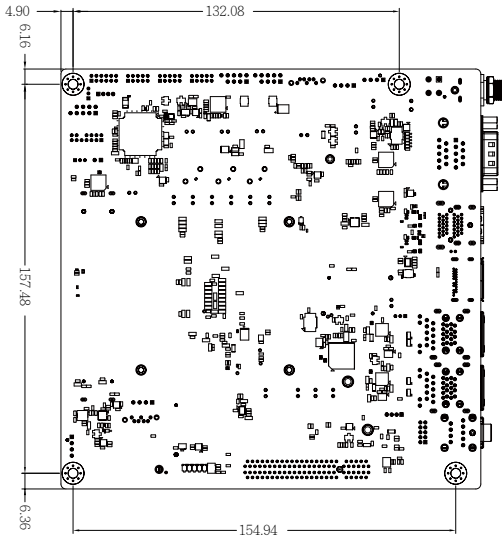
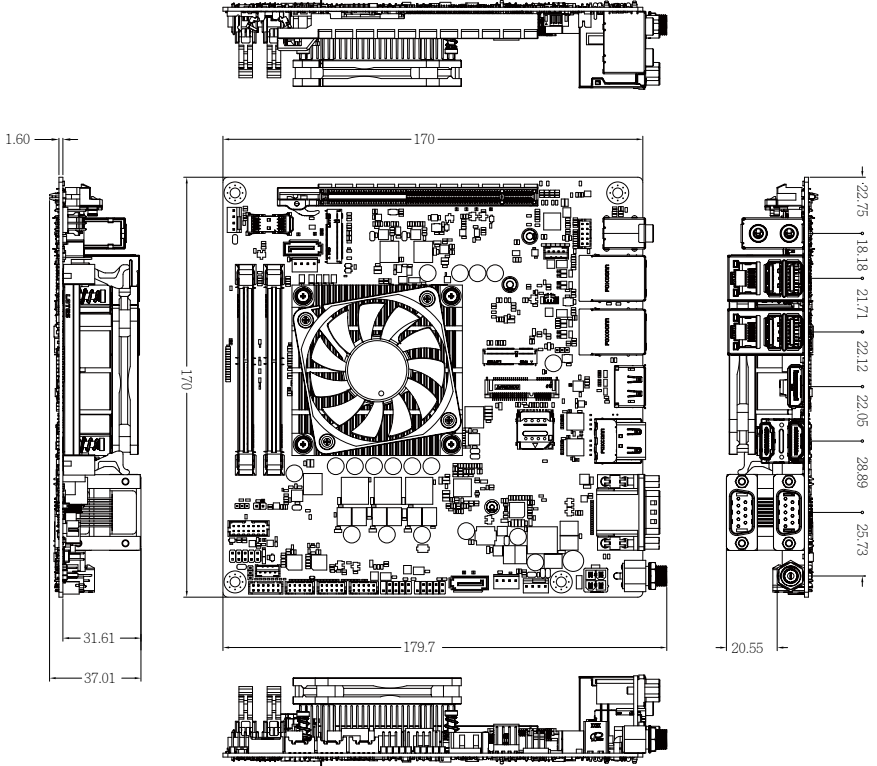

## 1.1 Specifications

Motherboard	mITX-1505A (MRZNRMI)
Form Factor	Mini-ITX 170W x 170D (mm)
CPU	AMD Ryzen™ R1505G Embedded Processor with Radeon™ Vega 3 Graphics 2 cores, 4 threads, 2.4GHz, up to 3.3GHz TDP 25W
Socket	1 x FP5 Type 1
Chipset	SoC
Memory	2 x DDR4 SO-DIMM sockets, Max. Capacity 32 GB Support Dual channel DDR4 2400 MHz memory modules
Ethernet	2 x GbE LAN Ports
Video	Integrated Graphics Processor - AMD Radeon™ Vega 8 Graphics: 2 x HDMI ports, supporting a maximum resolution of 4096x2160 @60Hz 1 x DP port, supporting a maximum resolution of 3840x2160 @60Hz  (3 independent display outputs)
Audio	Realtek® Audio Codec
Storage	2 x SATA 6Gb/s Ports
Expansion Slots	1 x PCIe x16 (Gen3 x4) 1 x 2280 M.2 M-Key (SATA 6Gb/s) 1 x 2230 M.2 E-Key (PCIe x1 + USB 2.0) 1 x Full-size Mini PCIe with SIM slot (PCIe x1 + USB 2.0)



Motherboard	mITX-1505A (MRZNRMI)
Internal I/O	1 x 4-pin ATX main power connector 2 x SATA power connectors 1 x CPU fan header 1 x System fan header 1 x Front panel header 1 x Front panel audio header 1 x 2W Speaker out header 1 x Chassis Intrusion detect header 4 x USB 2.0 headers 3 x COM header (RS-232) 1 x ccTalk header 1 x GPIO (8 bits) & SMBus header 1 x Clear CMOS jumper 1 x AT/ATX mode select jumper
Rear I/O	2 x Audio Jacks (Line out, Mic in) 2 x COM Ports (RS-232) 2 x HDMI 1 x Display Port 2 x RJ45 LAN Ports 4 x USB 3.2 Gen 1 1 x DC Jack (+12~24VDC)
TPM	1 x TPM header
OS Compatibility	Windows 10 (x64)
Operating Properties	Operating temperature: 0°C to 60°C Operating humidity: 0-90% (non-condensing) Non-operating temperature: -40°C to 85°C Non-operating humidity: 0%-95% (non-condensing)
Order Information	9MRZNRMIMR-SI (Box packing)

# Chapter 2

---

## Chapter 2 – Hardware Information

## 2.1 Jumpers and Connectors

---

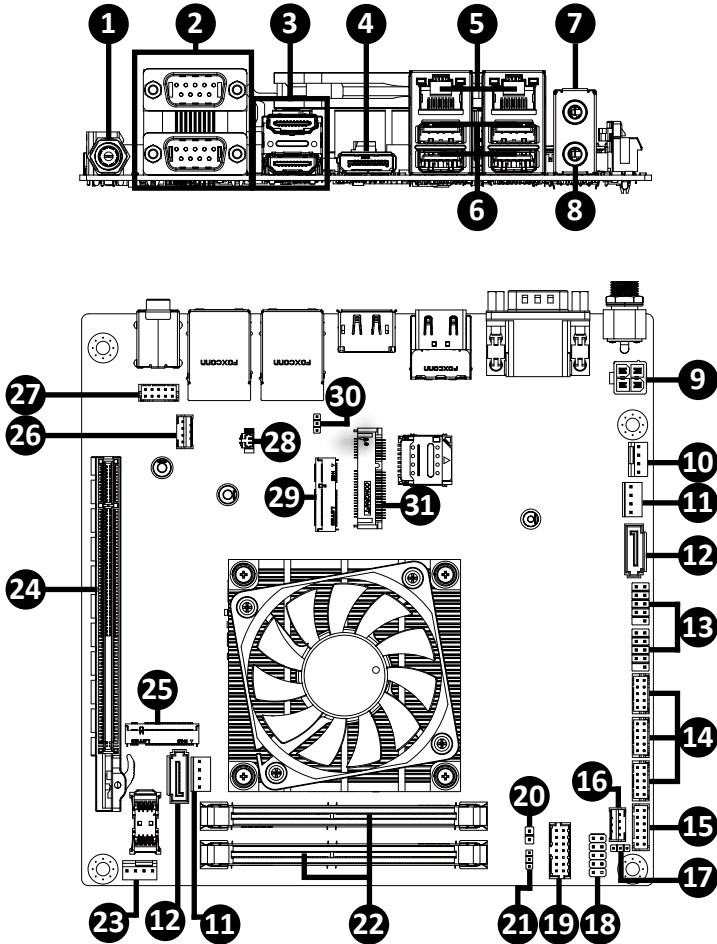

No	Code	Description
1	DC_IN1	DC IN Jack connector
2	COM1_2	COM Port (RS-232)
3	HDMI_21	HDMI connector
4	DP	Display ports
5	USB3_LAN1	LAN Connector x 2
6	USB3_LAN2	USB 3.2 Gen 1 Connector x 4
7	AUDIO	Line Out port (Green)
8		Mic In port (Pink)
9	DC_IN2	ATX 2x2 pin power connector
10	SYS_FAN	System fan connector
11	SATAPW0 SATAPW1	SATA power connector
12	SATA0 SATA1	SATA 6Gb/s connector
13	F_USB2_1, F_USB2_2	USB 2.0 header
14	COM3, COM4, COM5	COM Port (RS-232)
15	GPIO_CNT	General Purpose input/output header
16	CCTALK	ccTalk header
17	CC_PWR	ccTalk power jumper
18	SYS_PANEL	Front panel header
19	TPM_LPC	TPM header
20	CI	Chassis Intrusion detect header

No	Code	Description
21	AT_CN	AT/ATX mode select jumper
22	SODIMM1, SODIMM2	2 x DDR4 SO-DIMM slots
23	CPU_FAN	CPU FAN connector
24	PCIEX4	PCIe x16 (Gen3 x4) slot
25	M2M	M.2 Slot, M-Key NGFF 2280
26	SPK_OUT	Speaker out connector
27	F_AUDIO	Front panel audio header
28	BAT	Battery connector
29	M2E	M.2 Slot, E-Key NGFF 2230
30	CLR_CMOS	Clear CMOS jumper
31	MPCIE	MINI PCIe connector

## 2.2.1 IO Connector Information

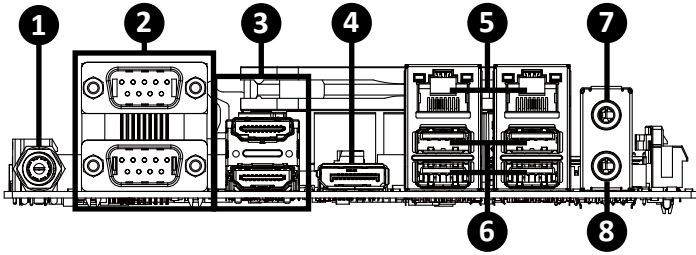

	Code	Description
1	DC_IN1	DC IN Jack connector
2	COM1_2	COM Port (RS-232)
3	HDMI_21	HDMI connector
4	DP	Display ports
5	USB3_LAN1	LAN Connector x 2
6	USB3_LAN2	USB 3.2 Gen 1 Connector x 4
7	AUDIO	Line Out port (Green)
8		Mic In port (Pink)

## 2.2.2 DC\_IN1 (DC IN Jack connector)

1

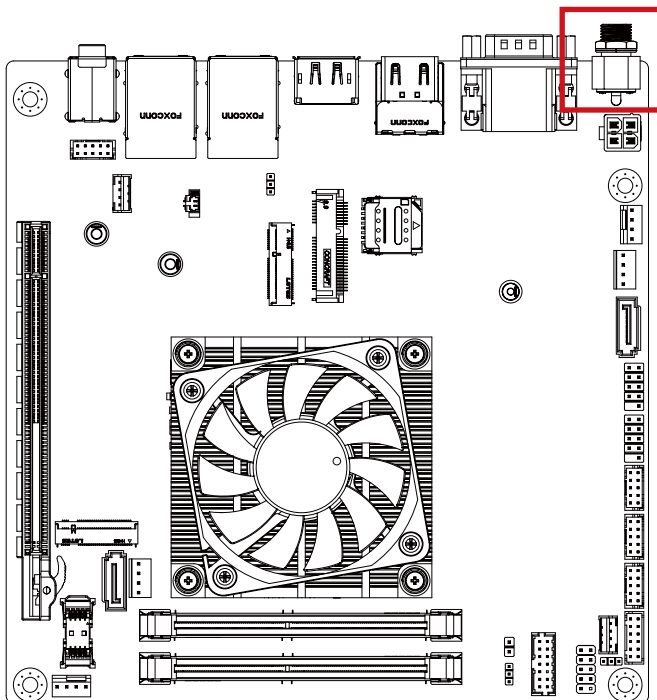

DC In Jack connector



Connector PN

655-360-000

Vendor

SHEN-MING

## 2.2.3 COM1\_2 (COM Port (RS-232))

2

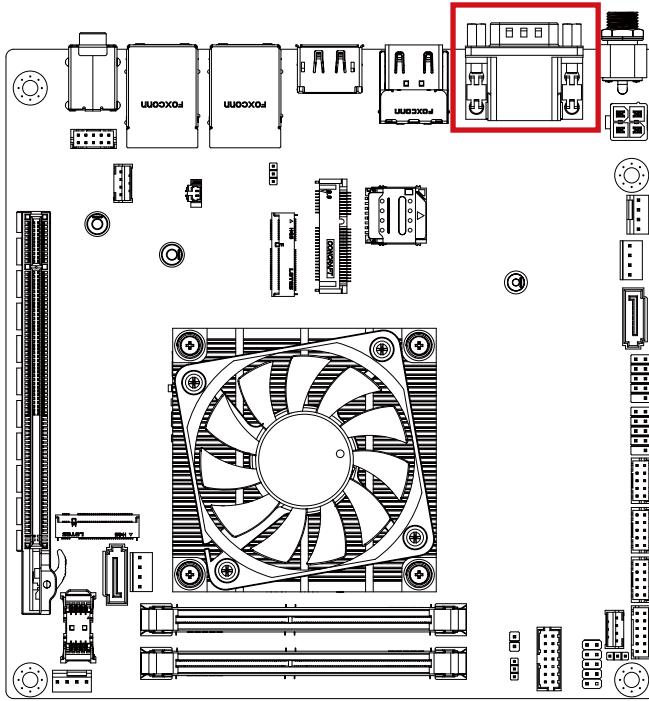

Serial Port connector

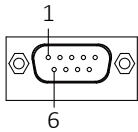

Connector PN

D20HB1102002P6JN

Vendor

FENYING

Pin No.	Definition
1	DCD
2	RXD
3	TXD
4	DTR
5	GND
6	DSR
7	RTS
8	CTS
9	RI



## 2.2.4 HDMI\_21 (HDMI connector)

3

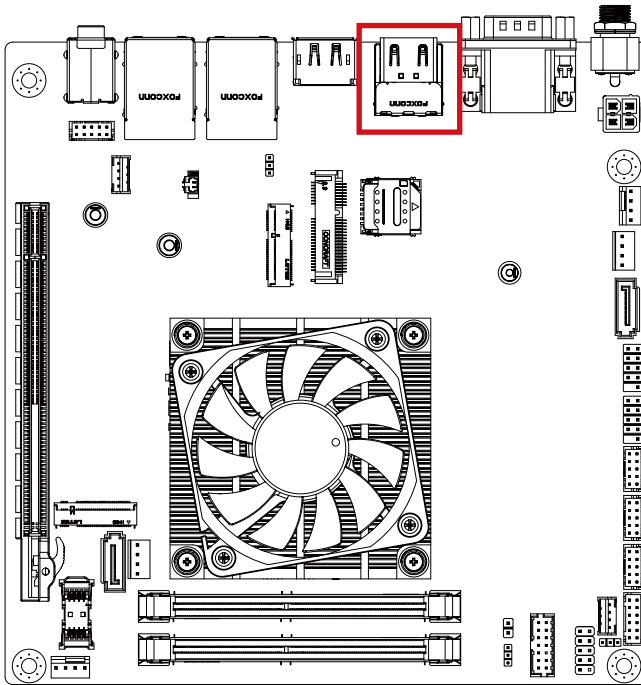

HDMI Connector

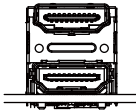

Connector PN

QJ11191-DFB1-4F

Vendor

FOXCONN

Pin No.	Definition	Pin No.	Definition
1	TX2p	11	GND
2	GND	12	CLKn
3	TX2n	13	NC
4	TX1p	14	NC
5	GND	15	SCL
6	TX1n	16	SDA
7	TX0p	17	GND
8	GND	18	5V
9	TX0n	19	Hot Plug Detect
10	CLKp		

## 2.2.5 DP (Display port)

4

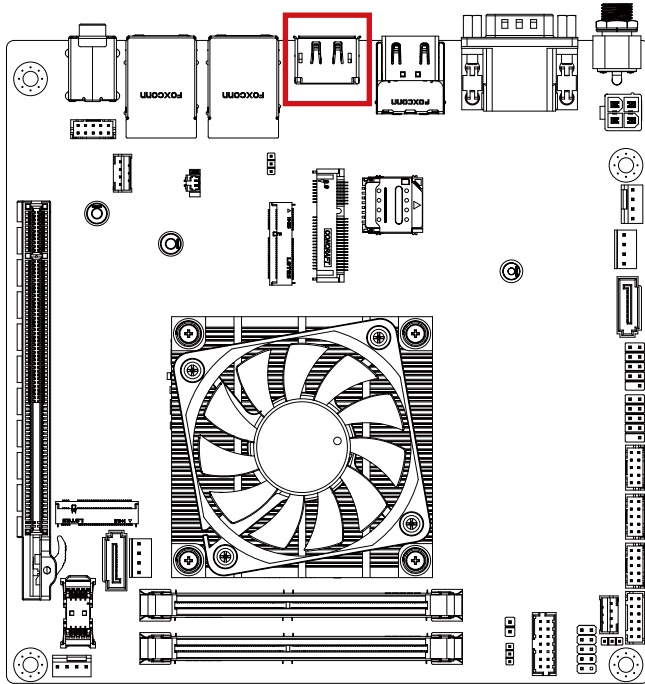

DP connector



Connector PN

3VD11207-D7AB-4H

Vendor

FOXCONN

Pin No.	Definition	Pin No.	Definition
1	TX0p	11	GND
2	GND	12	TX3n
3	TX0n	13	GND
4	TX1p	14	GND
5	GND	15	AUXp
6	TX1n	16	GND
7	TX2p	17	AUXn
8	GND	18	Hot Plug Detect
9	TX2n	19	GND
10	TX3p	20	3.3V

## 2.2.6 USB\_LAN1, USB\_LAN2 (USB+LAN connector x 2)

5 6

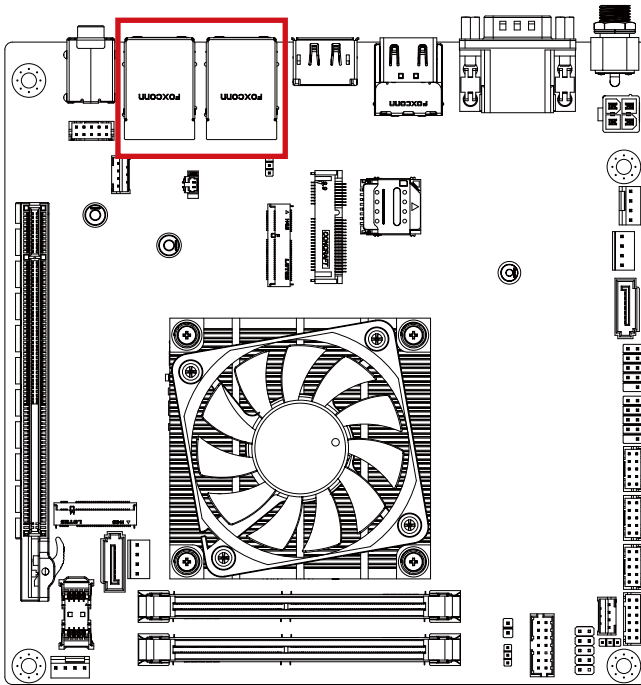

USB & LAN connector

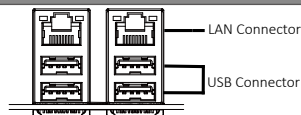

USB Connector			
Pin No.	Definition	Pin No.	Definition
1	5V	10	5V
2	D1n	11	D0n
3	D1p	12	D0p
4	GND	13	GND
5	USB3_RX1n	14	USB3_RX2n
6	USB3_RX1p	15	USB3_RX2p
7	GND	16	GND
8	USB3_TX1n	17	USB3_TX2n
9	USB3_TX1p	18	USB3_TX2p

LAN Connector			
Pin No.	Definition	Pin No.	Definition
1	BI_DA+	5	BI_DC-
2	BI_DA-	6	BI_DB-
3	BI_DB+	7	BI_DD+
4	BI_DC+	8	BI_DD-
State		Description	
Orange On		1Gbps data rate	
Green On		100Mbps data rate	
Off		10Mbps data rate	

## 2.2.7 DC\_IN2 (ATX 2x2 pin power connector)

9

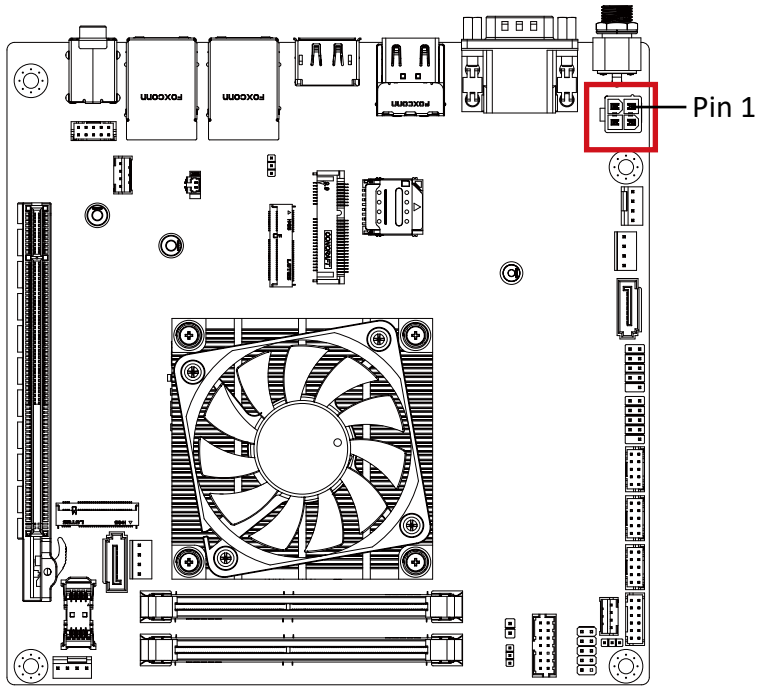

Power connector



Connector PN

740-81-04TW56

Vendor

PINREX

Pin No.	Definition
1	GND
2	GND
3	+12V~+24V
4	+12V~+24V

Pin No.	Definition
1	GND
2	GND
3	+12V~+24V
4	+12V~+24V

## 2.2.8 SYS\_FAN (System Fan connector)

10

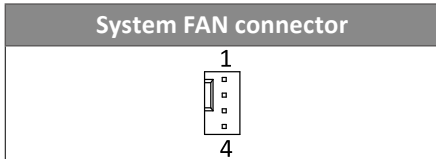
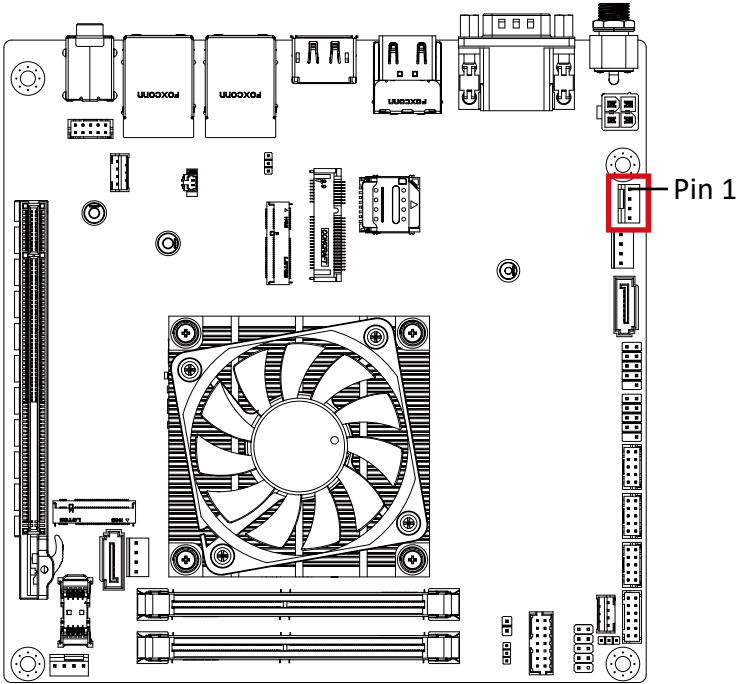

Connector PN	Vendor
744-81-045R11	PINREX
WF04R22RJQ105	HORNGTONG

Pin No.	Definition
1	GND
2	12V
3	Detect
4	Speed Control

## 2.2.9 SATAPW0, SATAPW1 (SATA power connector)

11

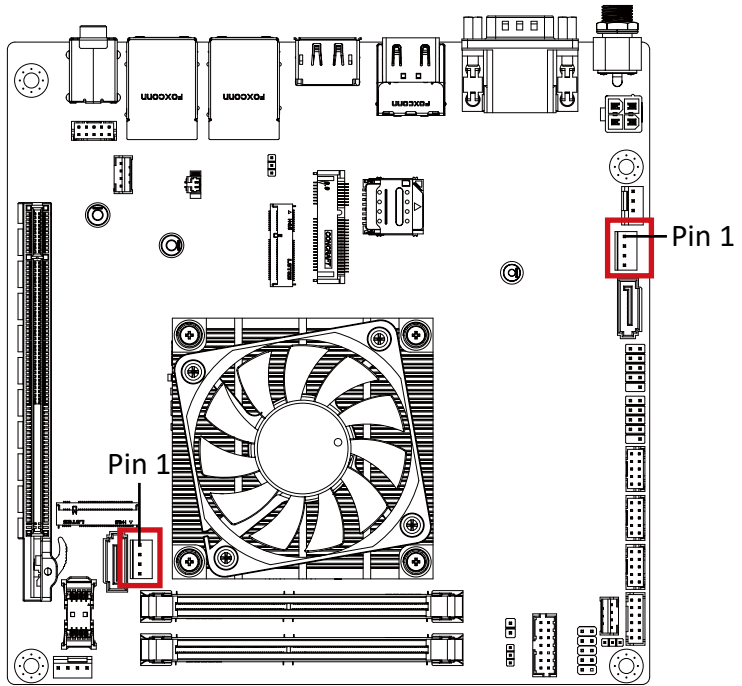

Hard Disk Power connector	

Connector PN	Vendor
743-81-04TW00	PINREX

Pin No.	Definition
1	12V
2	GND
3	GND
4	5V

## 2.2.10 SATA0, SATA1 (SATA 6Gb/s Connector)

12

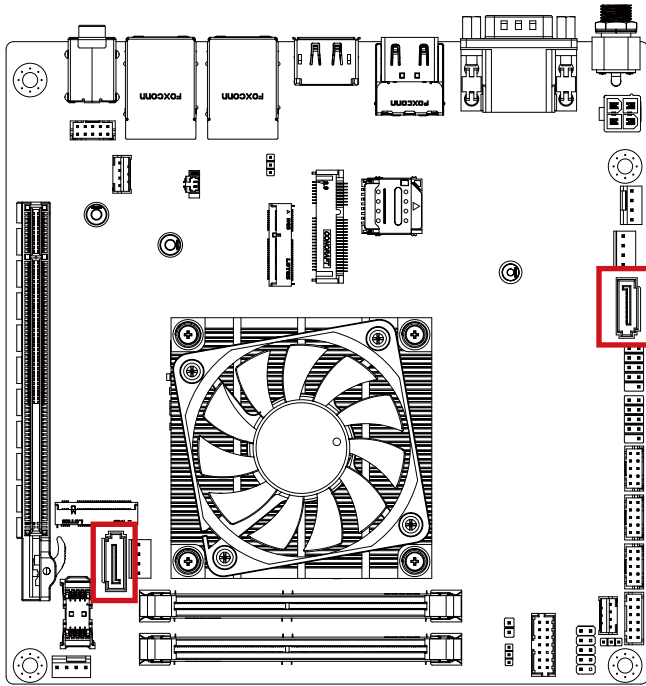

SATA 6Gb/s connector

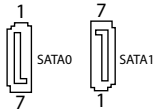

Pin No.	Definition
1	GND
2	TXp
3	TXn
4	GND
5	RXn
6	RXp
7	GND

Connector PN	Vendor
WATF-07DBLBA1UW	WINWIN
ABA-SAT-054-S15	LOTES

※NOTE : M.2 M-Key and SATA0 port share the same signal. When installing the storage on M.2 M-Key slot and SATA0 port at the same time, only M.2 storage will be detected.

## 2.2.11 F\_USB2\_1, F\_USB2\_2 (USB 2.0 header)

13

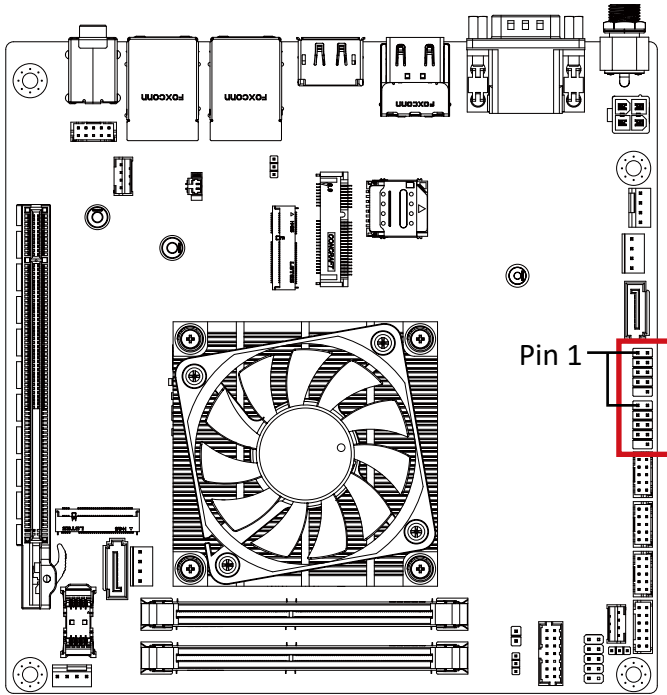

USB 2.0 header



Connector PN

210-92-05GB04  
PH10R53BAZ009

Vendor

PINREX  
HORNGTONG

Pin No.	Definition
1	5V
2	5V
3	D2n
4	D1n
5	D2p
6	D1p
7	GND
8	GND
9	No Pin
10	No Connect



## 2.2.12 COM3, COM4, COM5 (COM header (RS-232))

14

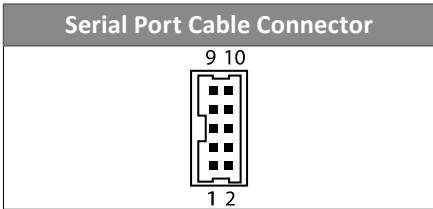
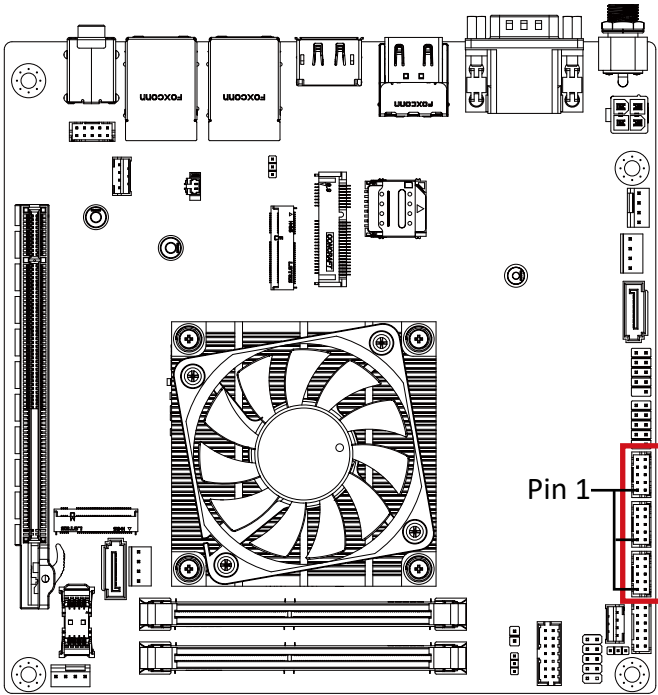

Connector PN	Vendor
725-81-10TW00	PINREX
A2004WV-2X05P46	JOINT-TECH

Pin No.	Definition	Pin No.	Definition
1	RXD	6	GND
2	DCD	7	CTS
3	DTR	8	RTS
4	TXD	9	No Connect
5	DSR	10	RI



## 2.2.14 CCTALK (ccTalk header)

16

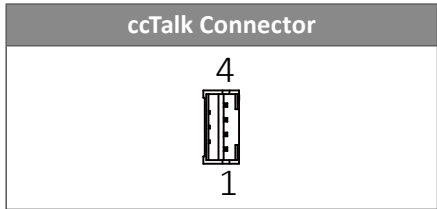
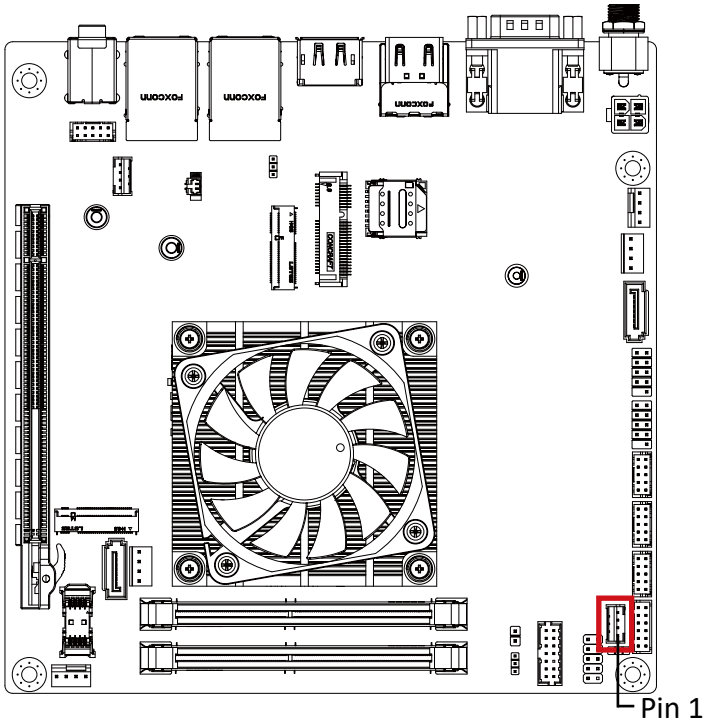

Connector PN	Vendor
721-81-045W00	PINREX
A2001WV-04P146	JOINT-TECH

Pin No.	Definition
1	5V/12V (Default 5V)
2	NC
3	GND
4	DATA (5V Level)

## 2.2.15 CC\_PWR (ccTalk power jumper)

17

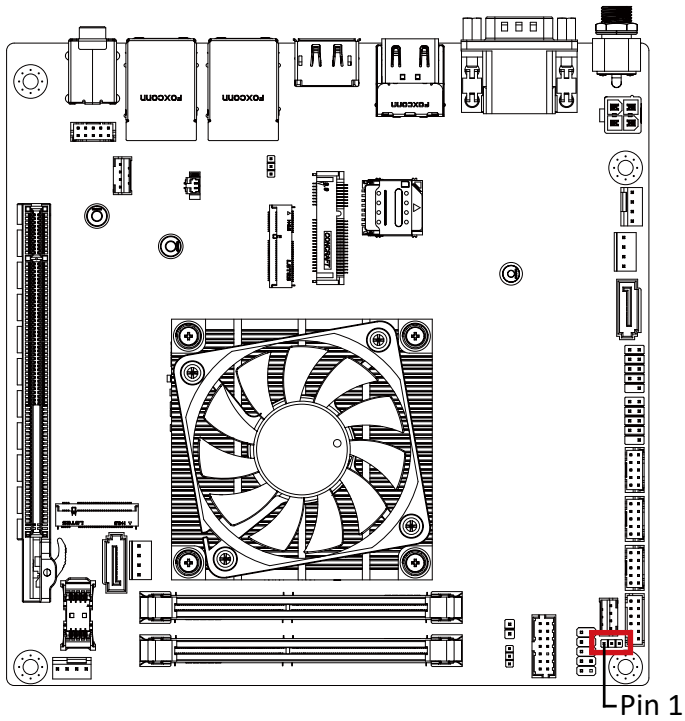

ccTalk power jumper



1

Connector PN

220-96-03GB01

PH03N2-7BAN000

Vendor

PINREX

HORNGTONG

Pin No.

Definition

1

5V

2

ccTalk\_Power

3

12V

Jumper setting

1-2 Close : 5V. (Default setting)

2-3 Close : 12V.

## 2.2.16 SYS\_PANEL (Front Panel Header)

18

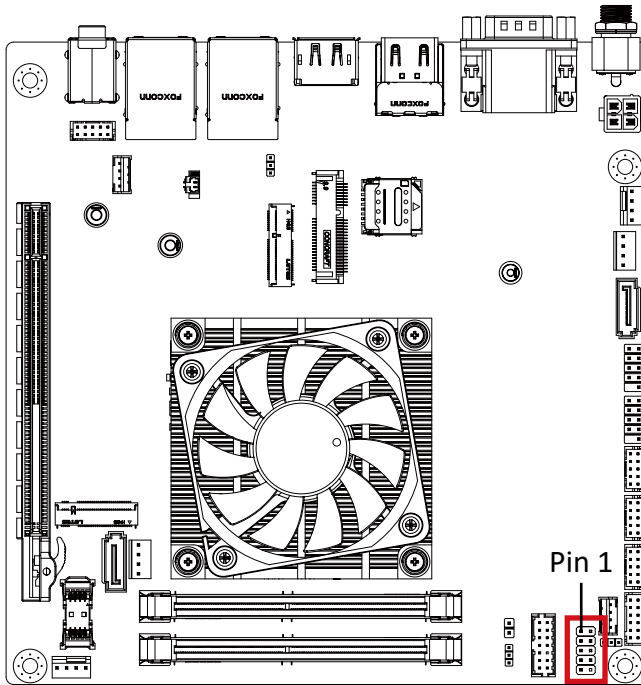

Pin 1

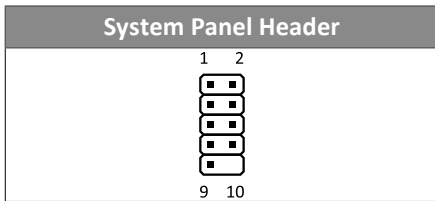

Connector PN	Vendor
210-92-05GW5W	PINREX

Pin No.	Definition
1	HDD LED+
2	Power LED+
3	HDD LED-
4	Power LED-
5	GND
6	Power Button+
7	Reset Button
8	Power Button-
9	No Connect
10	No Pin

## 2.2.17 TPM\_LPC (TPM header)

19

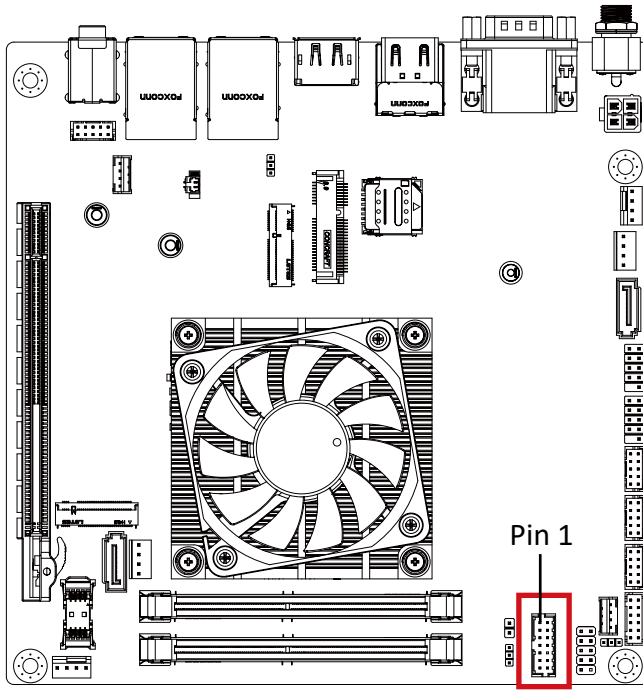

TPM Module Connector



Pin No.	Definition
11	LAD3
12	GND
13	LFRAME
14	GND

Pin No.	Definition
1	LPCCLK
2	3.3V
3	TPM_RST
4	3.3V
5	LAD0
6	IRQ_SERIAL
7	LAD1
8	TPM_DET
9	LAD2
10	NC

Connector PN	Vendor
52S-90-14GB10	PINREX
BH14NQ-7BAI010	HORNGTONG

## 2.2.18 CI (Chassis Intrusion detect header)

20

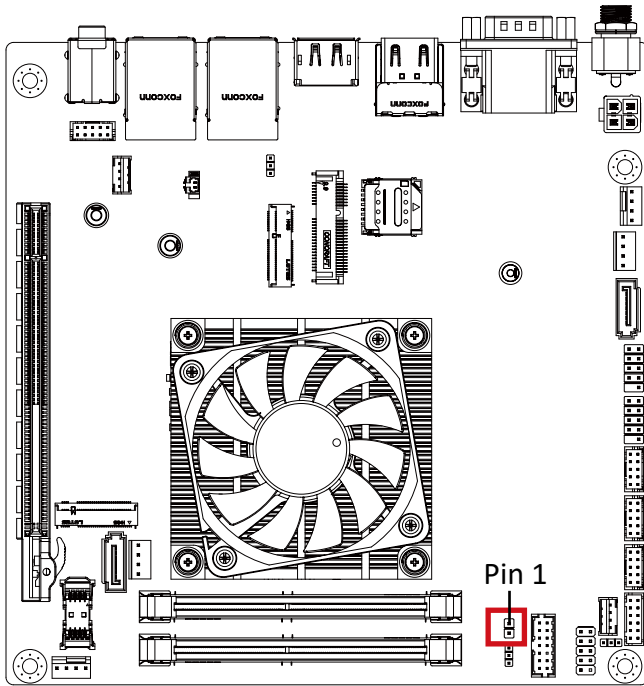

Chassis intrusion detect header



Pin No.	Definition
1	Signal
2	GND

## 2.2.19 AT\_CN (AT/ATX mode select jumper)

21

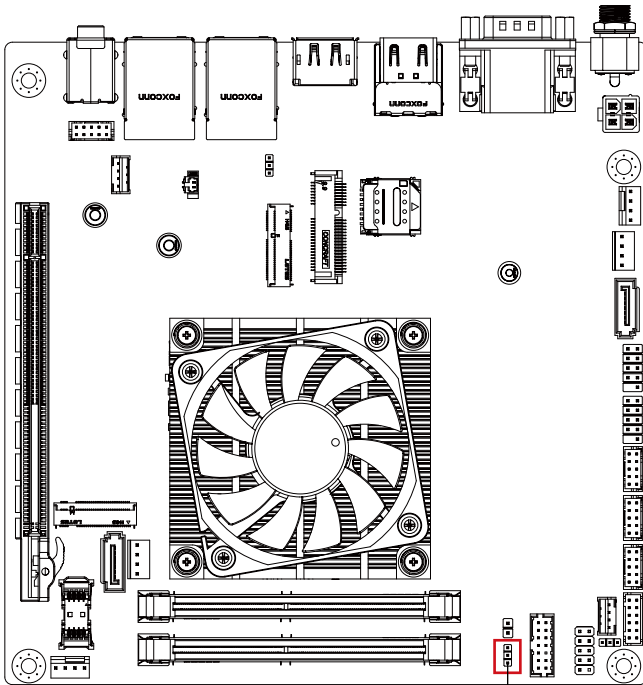

Pin 1

AT/ATX mode select jumper



Connector PN

220-96-03GB01  
PH03N2-7BAN000

Vendor

PINREX  
HORNGTONG

Pin No.	Definition
1	AT MODE
2	Detect
3	ATX MODE

Jumper setting

1-2 Close : AT mode.

2-3 Close : ATX mode. (Default setting)



## 2.2.20 SODIMM1, SODIMM2 (2 x DDR4 SO-DIMM slots)

22

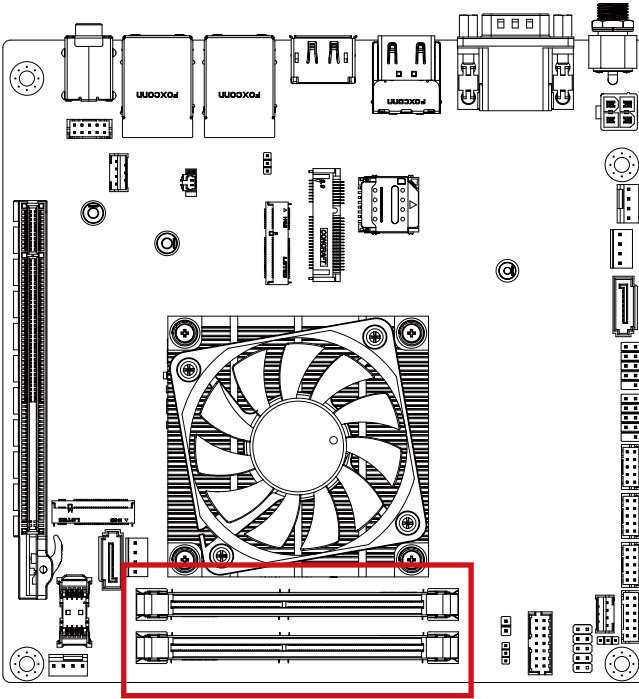

## 2.2.21 CPU\_FAN (CPU Fan connector)

23

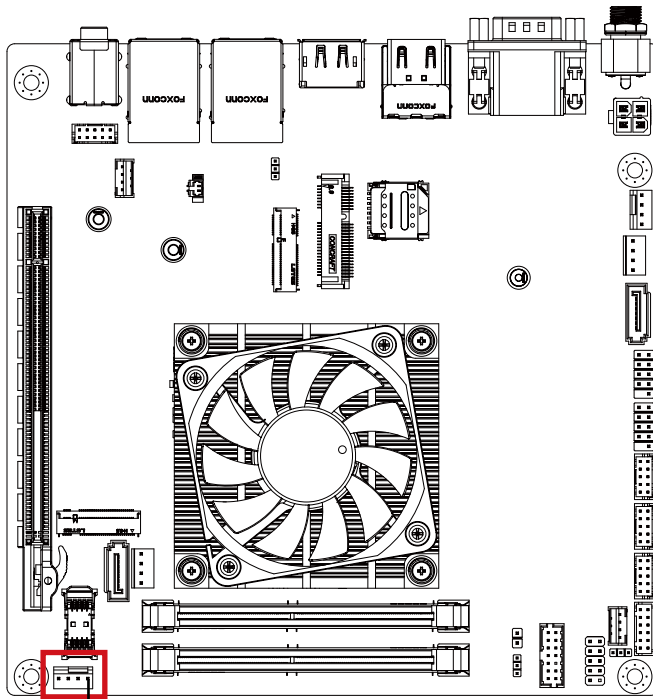

CPU FAN connector

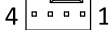

Connector PN
744-81-045W1Z

Vendor
PINREX

Pin No.	Definition
1	GND
2	12V
3	Detect
4	Speed Control

## 2.2.22 PCIEX4 (PCIe x16 (Gen3 x4) slot)

24

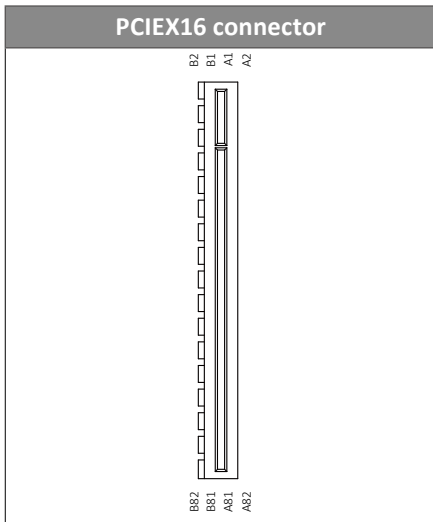
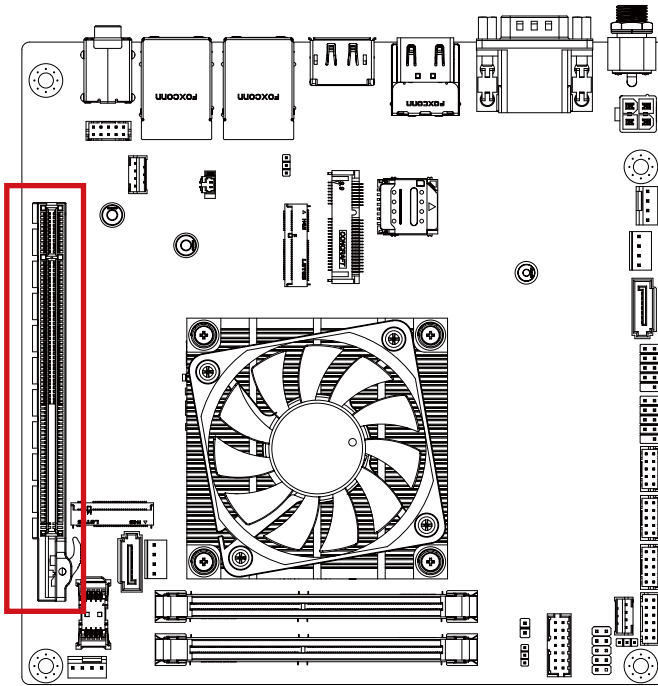

## 2.2.23 M2M (M.2 Slot, M-key NGFF 2280)

25

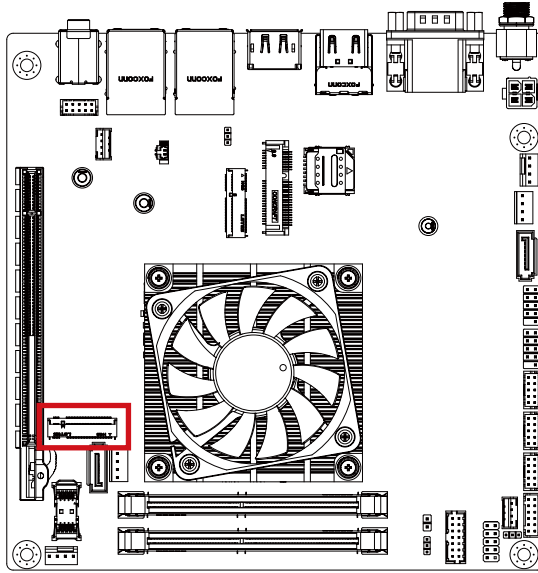

M.2 M Key Connector

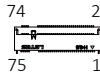

Pin No.	Definition	Pin No.	Definition
1	GND	2	3.3V
3	GND	4	3.3V
5	NC	6	NC
7	NC	8	NC
9	GND	10	SSD LED
11	NC	12	3.3V
13	NC	14	3.3V
15	GND	16	3.3V
17	NC	18	3.3V
19	NC	20	NC
21	GND	22	NC
23	NC	24	NC
25	NC	26	NC
27	GND	28	NC
29	NC	30	NC
31	NC	32	NC
33	GND	34	NC
35	NC	36	NC
37	NC	38	DEVSLP
39	GND	40	SMB Clock

Pin No.	Definition	Pin No.	Definition
41	SATA Bp	42	SMB Data
43	SATA Bn	44	SMB Alert
45	GND	46	NC
47	SATA An	48	NC
49	SATA Ap	50	PCI Reset
51	GND	52	NC
53	NC	54	NC
55	NC	56	NC
57	GND	58	NC

Pin No.	Definition	Pin No.	Definition
67	NC	68	SUSCLK
69	Detect	70	3.3V
71	GND	72	3.3V
73	GND	74	3.3V
75	GND		

Connector PN	Vendor
80159-8521	BELLWETHER

※NOTE : M.2 M-Key and SATA0 port share the same signal. When installing the storage on M.2 M-Key slot and SATA0 port at the same time, only M.2 storage will be detected.

## 2.2.24 SPK\_OUT (Speaker out connector)

26

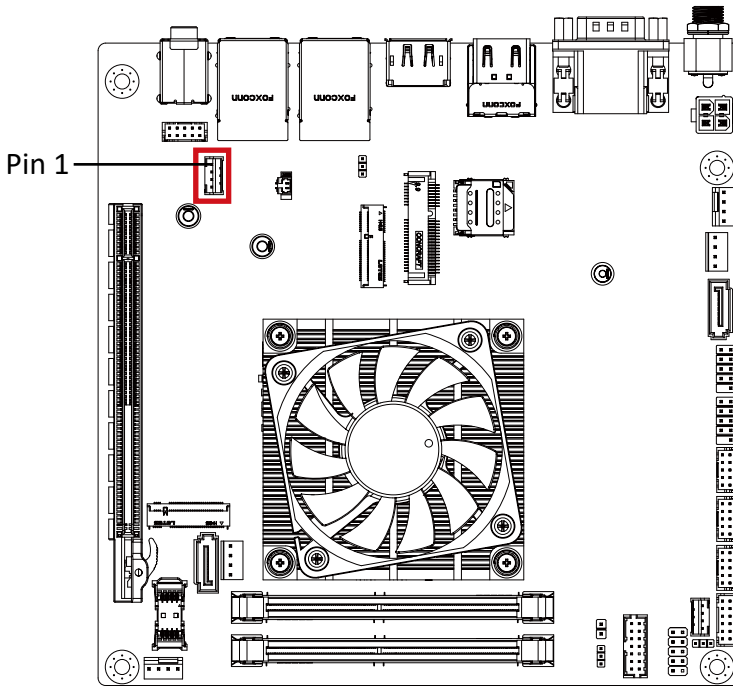

Audio Amplifier Connector



Connector PN

Vendor

721-81-045W00

PINREX

A2001WV-04P146

JOINT-TECH

Pin No.	Definition
1	Speaker Out R+
2	Speaker Out R-
3	Speaker Out L-
4	Speaker Out L+

## 2.2.25 F\_AUDIO (Front panel audio header)

27

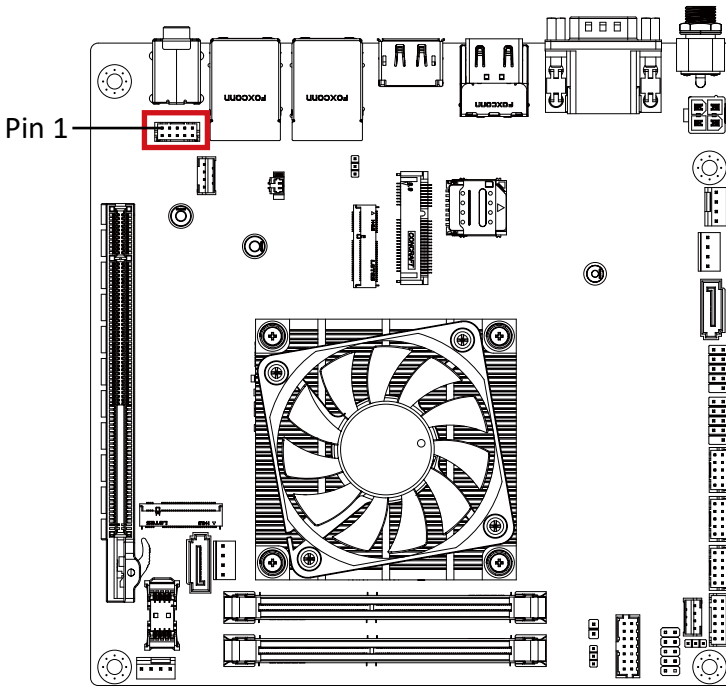

Front panel audio header

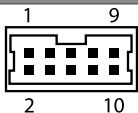

Connector PN

725-81-10TW00  
A2004WV-2X05P46

Vendor

PINREX  
JOINT-TECH

Pin No.	Definition	Pin No.	Definition
1	MIC_Left	6	Detect
2	GND	7	FAUDIO_JD
3	MIC_Right	8	No Connect
4	Detect	9	HPOUT_L
5	HPOUT_R	10	Detect

## 2.2.26 BAT (Battery connector)

28

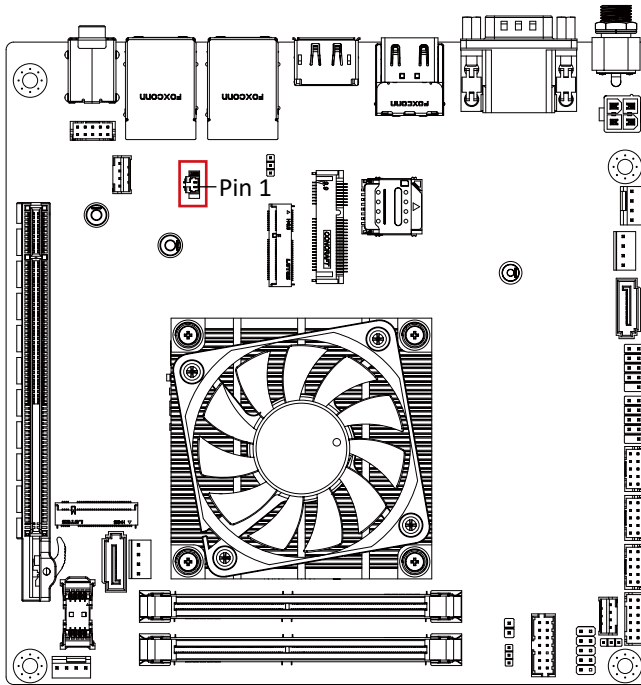

Battery Cable Connector



Connector PN

85205-0270L

Vendor

ACES

A1250WV-S-02PC

JOINT-TECH

Pin No.

Definition

1

3V

2

GND

## 2.2.27 M2E (M.2 Slot, E-key NGFF 2230)

29

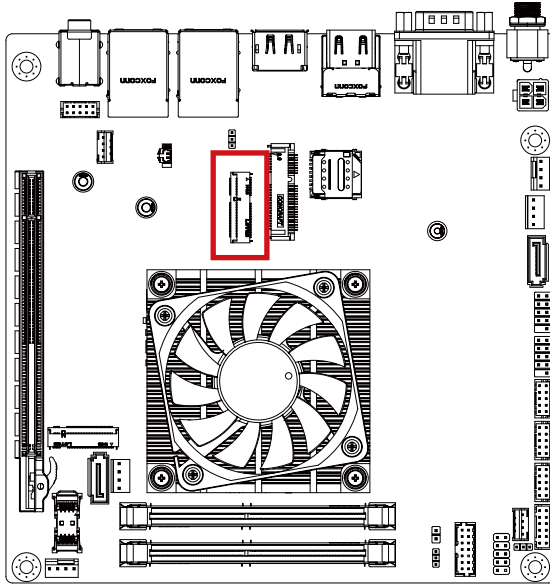

M.2 E Key Connector



Pin No.	Definition	Pin No.	Definition
1	GND	2	3.3V
3	D1p	4	3.3V
5	D1n	6	NC
7	GND	8	NC
9	NC	10	NC
11	NC	12	NC
13	NC	14	NC
15	NC	16	NC
17	NC	18	GND
19	NC	20	NC
21	NC	22	NC
23	NC		

Pin No.	Definition	Pin No.	Definition
33	GND	32	NC
35	PCIE_TXp	34	NC
37	PCIE_TXn	36	NC
39	GND	38	NC

41	PCIE_RXp	40	NC
43	PCIE_RXn	42	NC
45	GND	44	NC
47	PCIE_CLOCKp	46	NC
49	PCIE_CLOCKn	48	NC
51	GND	50	SUSCLK
53	PCIE Clock Request	52	PCIRST
55	PCIE wake up	54	BT_Disable
57	GND	56	WLAN_DISABLE
59	NC	58	NC
61	NC	60	NC
63	GND	62	NC
65	NC	64	NC
67	NC	66	NC
69	GND	68	NC
71	NC	70	NC
73	NC	72	3.3V
75	GND	74	3.3V

Connector PN	Vendor
80152-8521	BELLWETHER
APCI0095-P002A	LOTES



## 2.2.28 CLR\_CMOS (Clear CMOS jumper)

30

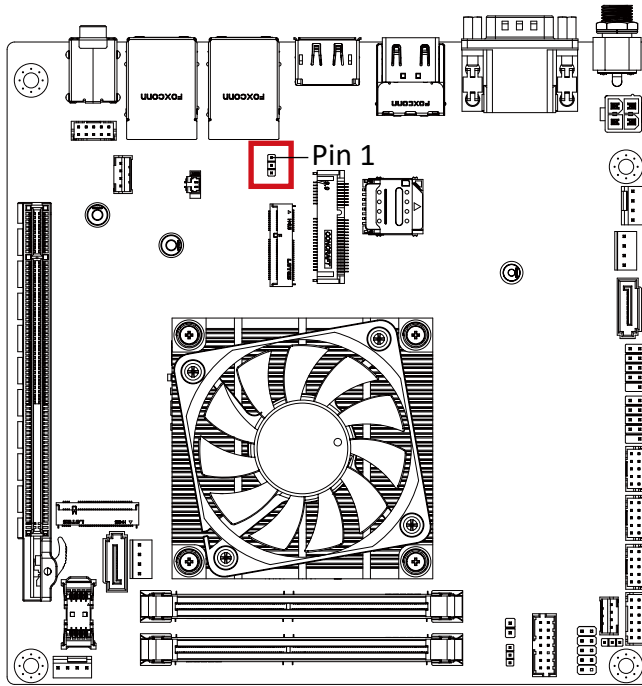

Clear CMOS Jumper

Connector PN	Vendor
220-96-03GB01	PINREX
PH03N2-7BAN000	HORNGTONG

Pin No.	Definition
1	GND
2	RTCVDD_C
3	No Connect
1-2 Close: Clear CMOS data. 2-3 Close: Normal Operator (Default setting)	

## 2.2.29 MPCIE (Mini PCIE connector)

31

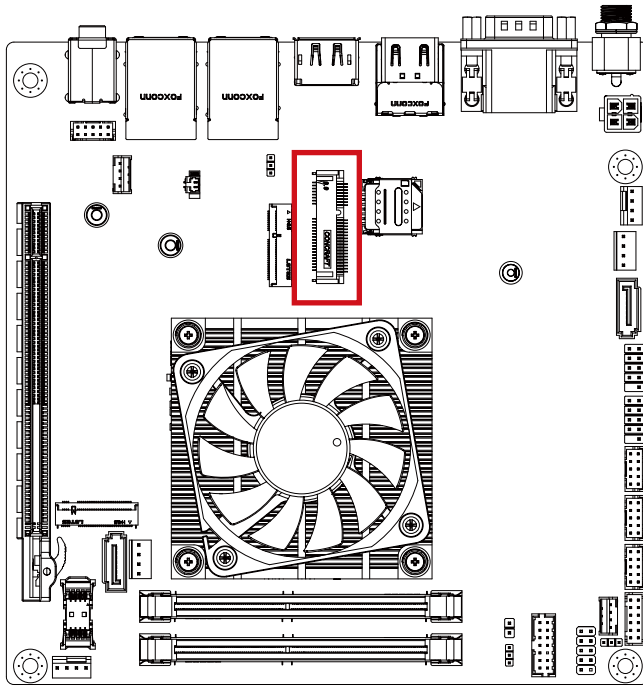

Mini PCIe Connector

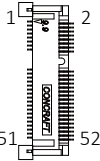

Pin No.	Definition	Pin No.	Definition
1	PCIE WAKE	2	3.3V
3	NC	4	GND
5	NC	6	NC
7	PCIE Clock Request	8	SIM PWR
9	GND	10	SIM DATA
11	PCIE Clock n	12	SIM Clock
13	PCIE Clock p	14	SIM Reset
15	GND	16	UIM VPP3
17	NC	18	GND
19	NC	20	WLAN_DISABLE
21	GND	22	Reset

Pin No.	Definition	Pin No.	Definition
23	PCIE RXn	24	3.3V
25	PCIE RXp	26	GND
27	GND	28	NC
29	GND	30	SMB Clock
31	PCIE TXn	32	SMB DATA
33	PCIE TXp	34	GND
35	GND	36	USB Dn
37	GND	38	USB Dp
39	3.3V	40	GND
41	3.3V	42	NC
43	GND	44	NC
45	NC	46	NC
47	NC	48	NC
49	NC	50	GND
51	NC	52	3.3V

Connector PN	Vendor
ASOB221-S99Q-7H	FOXCONN

# Chapter 3

---

## Chapter 3 – BIOS

## 3.1 Introduction

BIOS (Basic input/output system) provides hardware detailed information and boot-up options, which include firmware to control, set-up and test all hardware settings. Therefore, BIOS is the communication bridge between OS/application software and hardware.

### 3.1.1 How to Entering into BIOS menu

Once the system is power on, press the <DEL> key as soon as possible to access into BIOS Setup program.

### 3.1.2 Function Keys to setup in BIOS Setup program

Function keys	Description
→←	Select Screen
↑↓	Select Item
Enter	Execute command or enter the submenu
+	Increase the numeric value or make changes
—	Decrease the numeric value or make changes
F1	General Help
F2	Previous Values
F3	Load Optimized Defaults Settings
F4	Save changes & Exit the BIOS Setup program
ESC	Exit the BIOS Setup program

## 3.2 The Main Menu

The main menu shows the basic system information. Use arrow keys to move among the items.

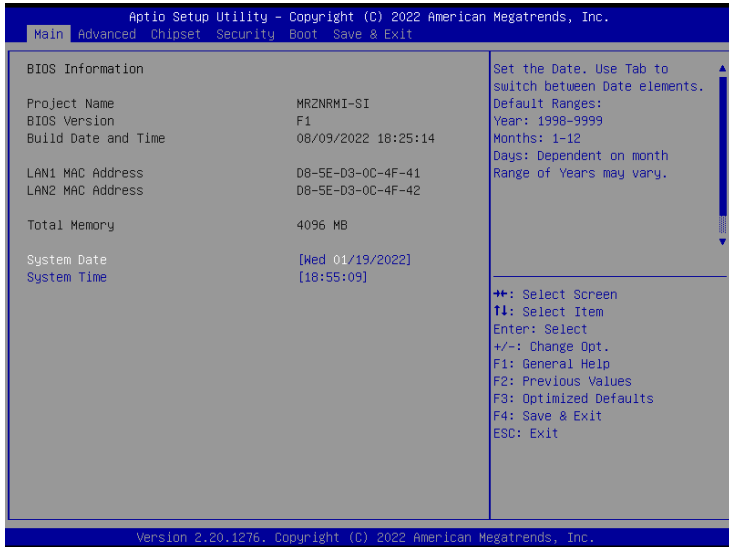

Items	Description
<b>Project Name</b>	<b>Shows Project name information</b>
<b>BIOS Version</b>	<b>Shows the BIOS version of the system</b>
<b>Build Date and Time</b>	<b>Shows the Build Date and Time when the BIOS was created.</b>
<b>LAN1 MAC Address</b>	<b>Shows LAN1 MAC Address information</b>
<b>LAN2 MAC Address</b>	<b>Shows LAN2 MAC Address information</b>
<b>Total Memory</b>	<b>Shows the total memory size of the installed memory</b>
<b>System Date</b>	<b>Set the Date for the system (Format : Week - Month - Day - Year)</b>
<b>System Time</b>	<b>Set the time for the system (Format : Hour - Minute - Second)</b>

### 3.3 Advanced

The Advanced menu is to configure the functions of hardware settings through submenu. Use arrow keys to move among the items, and press <Enter> to access into the related submenu.

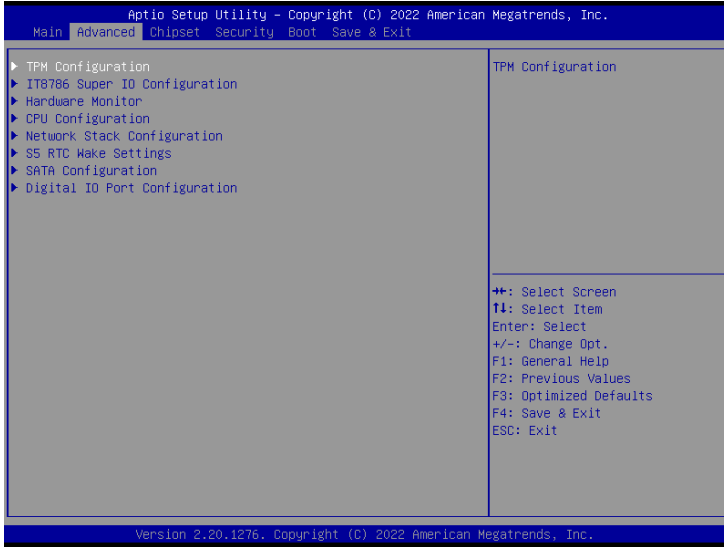

### 3.3.1 TPM Configuration

Use TPM Configuration submenu to choose TPM interface.

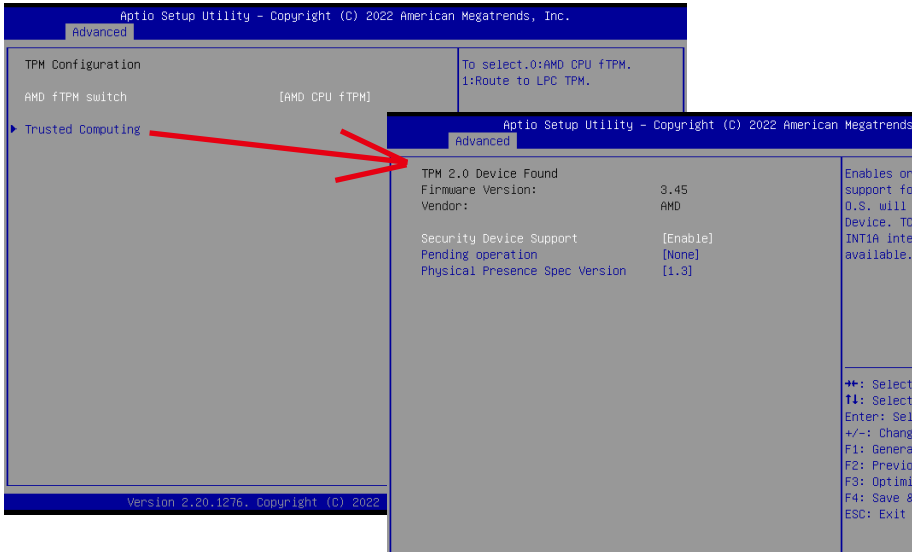

Item	Description
<b>AMD fTPM switch</b>	<b>AMD CPU fTPM : Enables AMD CPU firmwarm TPM (Default setting)</b> <b>Route to LPC TPM : Enables to route to LPC TPM</b>
<b>Trusted Computing</b>	Security Device Support : <b>Enabled : Enables TPM feature (Default setting)</b> <b>Disabled : Disables TPM feature</b>  Pending operation : <b>None : No execution will be conducted (Default setting)</b> <b>TPM clear : Set to clear data on TPM</b>  Physical Presence Spec Version : Choose PPI spec version <b>Option items : 1.2 or 1.3 (Default setting)</b>

### 3.3.2 IT8786 Super IO Configuration

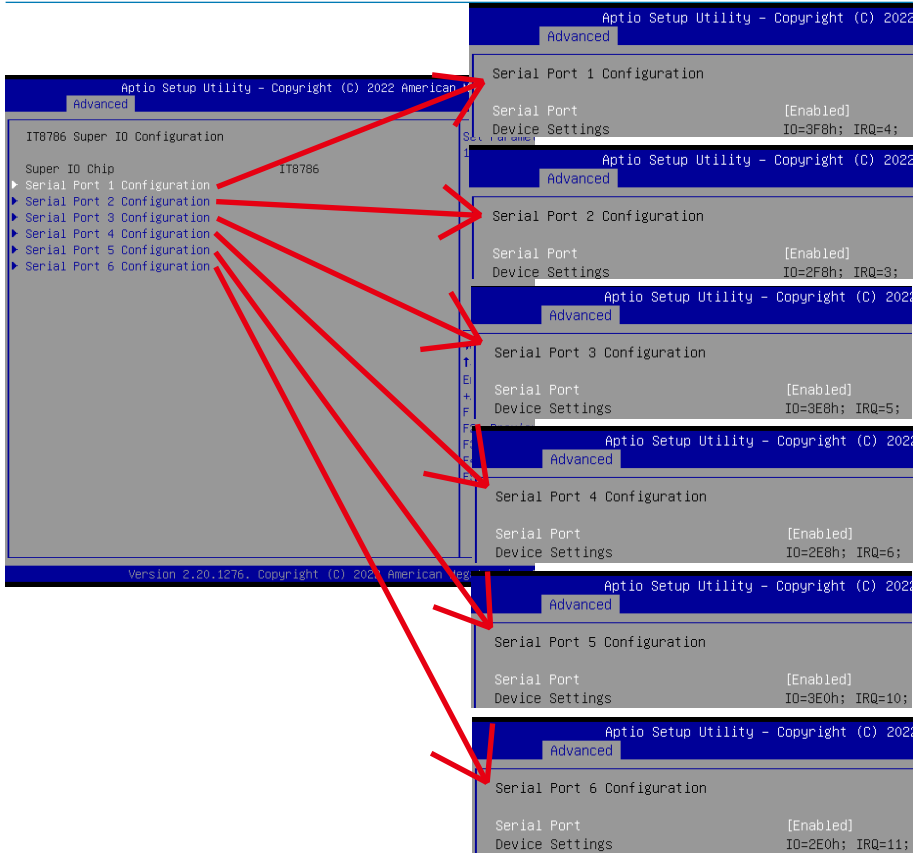

Item	Description
<b>Serial Port 1 Configuration</b>	
<b>Serial Port 2 Configuration</b>	Press [Enter] to configure advanced items :
<b>Serial Port 3 Configuration</b>	Serial Port : <b>Enabled : Enables allows you to configure the serial port settings</b> <b>Disabled : if Disabled, displays no configuration for the serial port</b>
<b>Serial Port 4 Configuration</b>	Device settings : Display the specified Serial Port base I/O address and IRQ
<b>Serial Port 5 Configuration</b>	
<b>Serial Port 6 Configuration</b>	For ccTalk function use Serial Port : <b>Enabled : Enables allows you to configure the serial port settings</b> <b>Disabled : if Disabled, displays no configuration for the serial port</b> Device settings : Display the specified Serial Port base I/O address and IRQ



## 3.3.3 Hardware Monitor

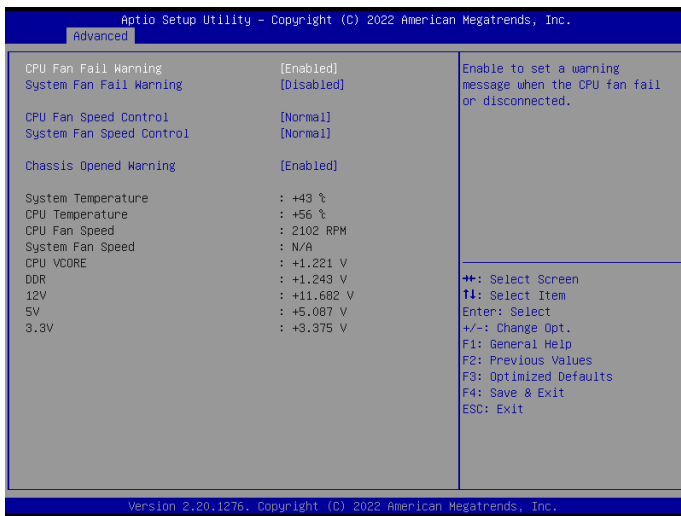

Item	Description
<b>CPU Fan Fail Warning</b>	<b>Enabled :</b> Enables CPU FAN Fail warning alert function (Default setting) <b>Disabled :</b> Disables CPU FAN Fail warning alert function
<b>System Fan Fail Warning</b>	<b>Enabled :</b> Enables CPU FAN Fail warning alert function <b>Disabled :</b> Disables CPU FAN Fail warning alert function (Default setting)
<b>CPU Fan Speed Control</b>	<b>Normal :</b> Fan speed set by BIOS default (Default setting) <b>Full Speed :</b> Set Fan operates at full speed
<b>System Fan Speed Control</b>	<b>Normal :</b> Fan speed set by BIOS default (Default setting) <b>Full Speed :</b> Set Fan operates at full speed
<b>Chassis Opened Warning</b>	To set a warning message on post screen when the chassis is opened. <b>Disabled :</b> without warning message when the chassis is opened <b>Enabled :</b> having warning message when the chassis is opened (Default setting) <b>Clear :</b> to clear the warning message on post screen
<b>System temperature</b>	Shows current CPU temperature
<b>CPU temperature</b>	Shows current system temperature
<b>CPU Fan Speed</b>	Shows current CPU Fan speed
<b>System Fan Speed</b>	Shows current system fan speed

### 3.3.4 CPU Configuration

This submenu shows detailed CPU informations.

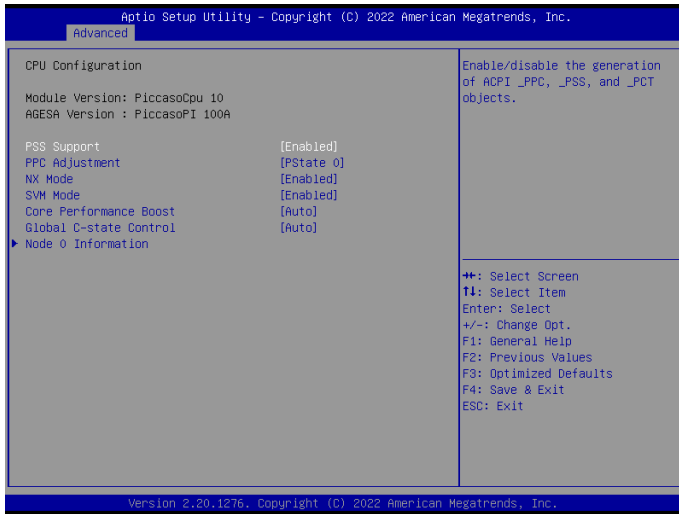

Item	Description
<b>PSS Support</b>	Allows you to get PState information <b>Enabled : Enables to get PState information (Default setting)</b> <b>Disabled : Disables to get PState information</b>
<b>PPC Adjustment</b>	To adjust the PState of the CPU <b>Option items : PState 0 (Default setting), PState 1, PState 2</b>
<b>NX Mode</b>	Enables or Disables the No-execute page-protection function. <b>Enabled : Enables Turbo Mode (Default setting)</b> <b>Disabled : Disables Turbo Mode</b>
<b>SVM Mode</b>	Enables or Disables the CPU virtualization funtion. <b>Enabled : Enables SVM Mode (Default setting)</b> <b>Disabled : Disables SVM Mode</b>
<b>Core Performance Boost</b>	To let CPU transits to a higher frequency. <b>Disabled : Disables Core Performance Boost</b> <b>Auto : System will automatically allocate its' frequency</b>
<b>Global C-state Control</b>	Command CPU to enter into low power consumption mode when CPU is under idle mode. <b>Enabled : Enables Global C-states Control (Default setting)</b> <b>Disabled : Disables Global C-states Control</b> <b>Auto : System will automatically detect (Default setting)</b>
<b>Node 0 Information</b>	Shows AMD CPU information

## 3.3.5 Network Stack Configuration

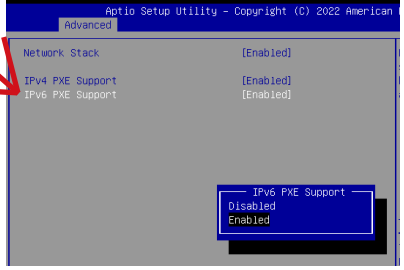
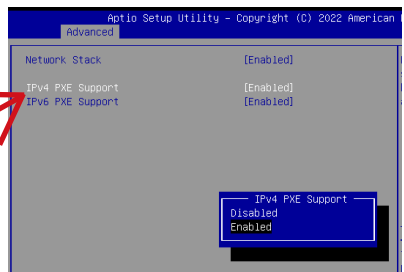
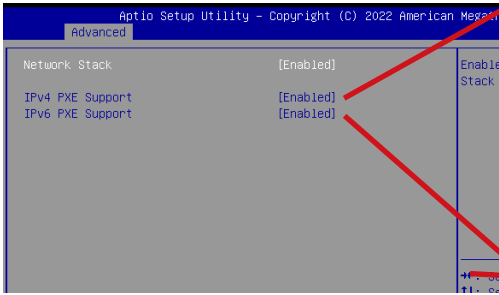
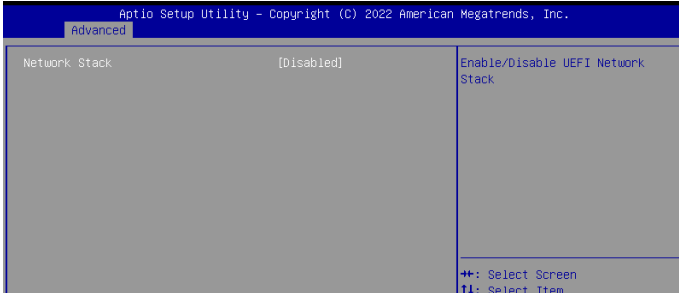

Item	Description
<b>Network Stack</b>	When system is power on, install LAN driver under UEFI mode <b>Disabled : Disables UEFI Network Stack (Default setting)</b> <b>Enabled : Enables UEFI Network Stack</b>
<b>Ipv4 PXE Support</b>	When Network stack is enabled : <b>Disabled : Disables Ipv4 PXE Support</b> <b>Enabled : Enables Ipv4 PXE Support</b>
<b>Ipv6 PXE Support</b>	When Network stack is enabled : <b>Disabled : Disables Ipv6 PXE Support</b> <b>Enabled : Enables Ipv6 PXE Support</b>

### 3.3.6 S5 RTC Wake Settings



Item	Description
<b>Wake system from S5</b>	Enable or Disable System to wake on a specific time. <b>Disabled : Disables system to wake on a specific time (Default setting)</b> <b>Fixed Time : Enables system to wake on a specific time (Format : hr : min : sec)</b>

### 3.3.7 SATA Configuration

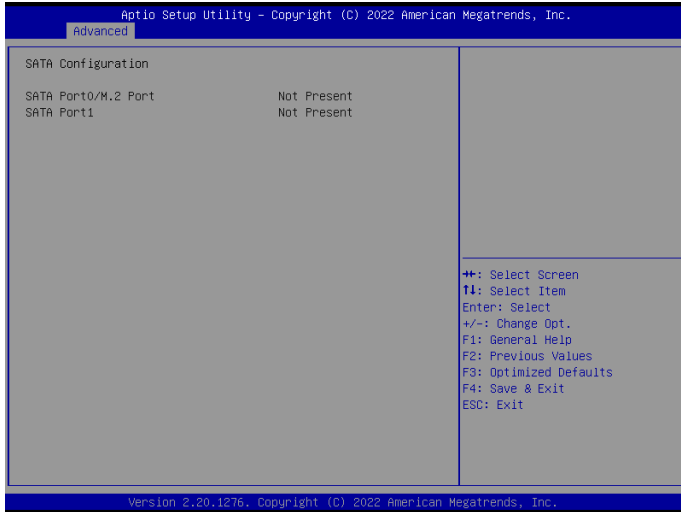

### 3.3.8 Digital IO Port Configuration

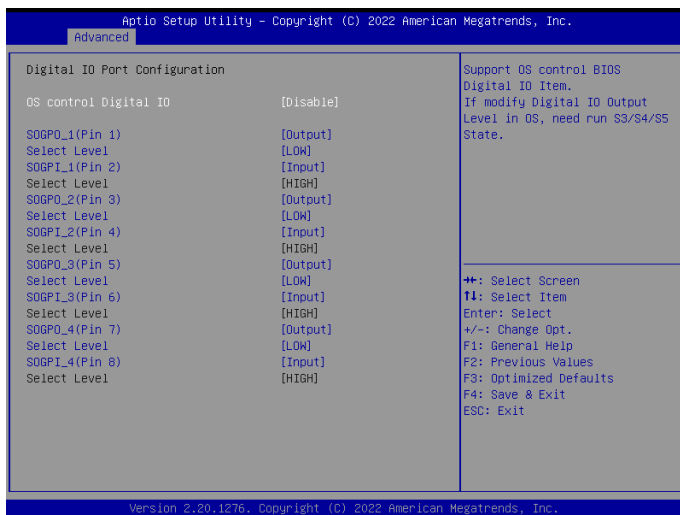

Item	Description
OS control Digital IO	<p><b>Disabled</b> : If Digital IO Output value/level is modified in OS, they will not be memorized and kept. (Default setting)</p> <p><b>Enabled</b> : If Digital IO Output value/level is modified in OS, they will be memorized and kept.</p>
<p>SOGPO_1 (Pin 1)</p> <p>SOGPI_1 (Pin 2)</p> <p>SOGPO_2 (Pin 3)</p> <p>SOGPI_2 (Pin 4)</p> <p>SOGPO_3 (Pin 5)</p> <p>SOGPI_3 (Pin 6)</p> <p>SOGPO_4 (Pin 7)</p> <p>SOGPI_4 (Pin 8)</p>	Configure Digital IO Input or Output values for each pin.

## 3.4 Chipset

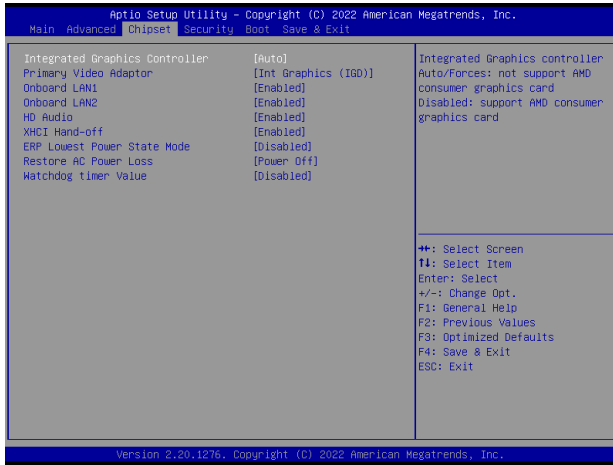

Item	Description
<b>Integrated Graphics Controller</b>	Enables or disables the onboard graphics function <b>Auto : System will automatically enables or disables the onboard graphics depending on the graphics card being installed. (Default setting)</b> <b>Forces : Disables the onboard graphics.</b>
<b>Primary Video Adaptor</b>	Select to use internal or external graphic. <b>Int Graphics (IGD) : Internal Graphic (Default setting)</b> <b>Ext Graphics (PEG) : External Graphics</b>
<b>Onboard LAN1 Onboard LAN2</b>	Enable/Disable onboard LAN controller <b>Enabled : Enables onboard LAN controller (Default setting)</b> <b>Disabled : Disables onboard LAN controller</b>
<b>HD Audio</b>	Enable/Disable onboard audio controller <b>Enabled : Enables onboard audio controller (Default setting)</b> <b>Disabled : Disables onboard audio controller</b>
<b>XHCI Hand-off</b>	Enable/Disable XHCI Hand-off function <b>Enabled : Enables XHCI Hand-off function (Default setting)</b> <b>Disabled : Disables XHCI Hand-off function</b>
<b>ErP Lowest Power State Mode</b>	Enable/Disable power saving funtion <b>Enabled : Enables ERP Lowest Power State Mode</b> <b>Disabled : Disabled ERP Lowest Power State Mode (Default setting)</b>
<b>Restore AC Power Loss</b>	To set which option the system should returns if a sudden power loss occurred <b>Power on : System power on when the power is back</b> <b>Power off : Do not power on when the power is back (Default setting)</b> <b>Last state : Restore the system to the state before power loss occurs</b>
<b>Watchdog timer Value</b>	Enable/Disable Watchdog Timer function <b>Option items : Disabled (Default setting), 30 Seconds, 60 Seconds</b>

## 3.5 Security

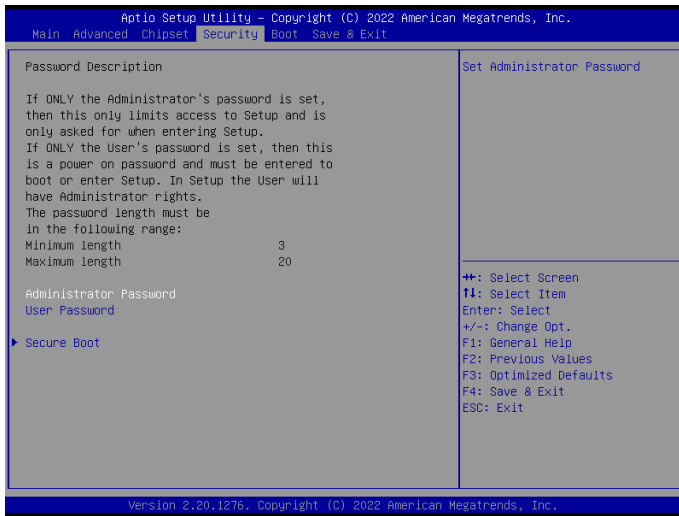

Item	Description
<b>Administrator Password</b>	To set up Administrator's password <b>Minimum length : 3</b> <b>Maximum length : 20</b>
<b>User Password</b>	To set up User's password <b>Minimum length : 3</b> <b>Maximum length : 20</b>
<b>Secure Boot</b>	Press <Enter> to configure the advanced items



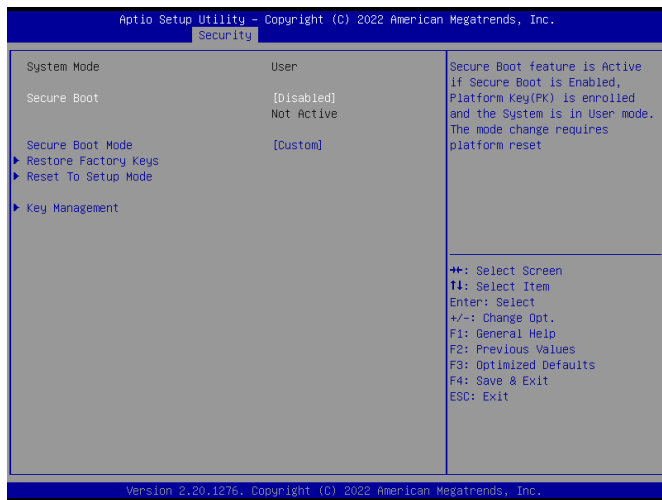

Item	Description
<b>Secure Boot</b>	Secure Boot requires all the applications that are running during the booting process to be pre-signed with valid digital certificates <b>Enabled : Enables Secure Boot function</b> <b>Disabled : Disables Secure Boot function (Default setting)</b>
<b>Secure Boot Mode</b>	<b>Standard : Standard mode</b> <b>Custom : Custom mode (Default setting)</b>
<b>Restore Factory Keys</b>	To restore factory settings <b>Yes : Agree to restore factory settings</b> <b>No : Cancel to restore factory settings</b>
<b>Reset To Setup Mode</b>	<b>Yes : Agree to setup mode</b> <b>No : Cancel to setup mode</b>
<b>Key Management</b>	Enables expert users to modify Secure boot policy variables without full authentication Press <Enter> to configure the advanced items

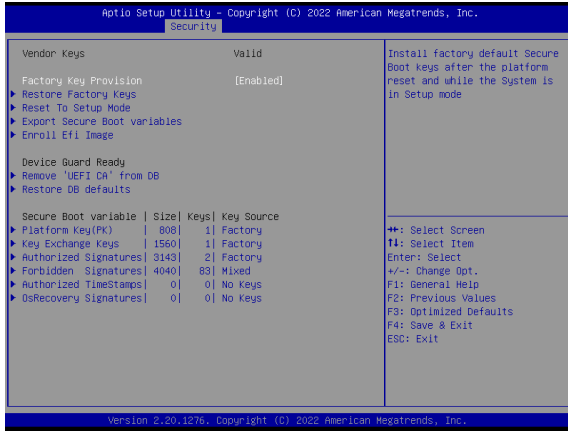

Item	Description
<b>Factory Key Provision</b>	Install factory default Secure Boot keys after the platform reset and while the system is in Setup mode <b>Enabled : Enables Factory Key Provision (Default setting)</b> <b>Disabled : Disables Factory Key Provision</b>
<b>Restore Factory Keys</b>	To restore factory settings <b>Yes : Agree to restore factory settings</b> <b>No : Cancel to restore factory settings</b>
<b>Reset To Setup Mode</b>	<b>Yes : Agree to setup mode</b> <b>No : Cancel to setup mode</b>
<b>Export Secure Boot variables</b>	Copy NVRAM content of Secure Boot variables to files in a root folder on a file system device
<b>Enroll Efi Image</b>	Allow the image to run in Secure Boot mode
<b>Remove 'UEFI CA' from DB</b>	To remove 'UEFI CA' from database <b>Yes : Agree to remove 'UEFI CA' from database</b> <b>No : Cancel to remove 'UEFI CA' from database</b>
<b>Restore DB defaults</b>	Restore DB variables to factory defaults <b>Yes : Agree to restore DB defaults</b> <b>No : Cancel to restore DB defaults</b>

Item	Description
<b>Platform Key (PK)</b>	These items allows you to enroll factory defaults or load Certificates from a file.
<b>Key Exchange Keys</b>	
<b>Authorized Signatures</b>	
<b>Forbidden Signatures</b>	
<b>Authorized TimeStamps</b>	
<b>OsRecovery Signatures</b>	

### 3.6 Boot

This Boot menu allows you to set/change system boot options



Item	Description
<b>Full Screen LOGO Show</b>	Enable/Disable full screen LOGO show on POST screen <b>Enabled : Enables Full screen LOGO Show on POST screen</b> <b>Disabled : Disables Full screen LOGO Show on POST screen (Default setting)</b>
<b>Boot Option #1</b>	Shows the information of the storage that be installed in the system <b>Choose/set the boot priority</b>

## 3.7 Save & Exit

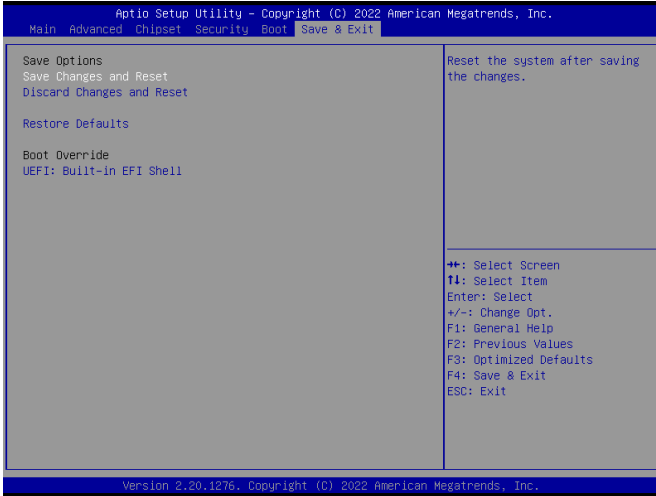

Item	Description
<b>Save Changes and Reset</b>	After configuring all the options that you wish to change, choose this option to save all the changes and reboot the system <b>Yes : Agree to save and reset</b> <b>No : Cancel to save and reset</b>
<b>Discard Changes and Reset</b>	Choose this option to reboot the system without saving any changes <b>Yes : Agree to discard changes and reset</b> <b>No : Cancel to discard changes and reset</b>
<b>Restore Defaults</b>	Restore/Load default values for all the setup options <b>Yes : Agree to load optimized defaults</b> <b>No : Cancel to load optimized defaults</b>
<b>Boot Override</b>	Boot override