CANopen Slave Device

CAN-2017C

Application User's Manual

Warranty

Without contrived damage, all products manufactured by ICP DAS are warranted in one year from the date of delivery to customers.

Warning

ICP DAS revises the manual at any time without notice. However, no responsibility is taken by ICP DAS unless infringement act imperils to patents of the third parties.

Copyright

Copyright © 2011 is reserved by ICP DAS.

Trademark

The brand name ICP DAS as a trademark is registered, and can be used by other authorized companies.

Contents

1	Introduction.....	3
1.1	Overview.....	3
1.2	Hardware Specifications	4
1.3	Features.....	5
1.4	Application	5
2	Hardware	6
2.1	Structure.....	6
2.2	Node ID & Baud Rate Rotary Switch	7
2.3	LED Description.....	8
2.4	PIN Assignment	9
2.5	Wire Connection	10
3	Application	11
3.1	Object Dictionary	11
3.2	Store and Restore Object.....	17
3.3	Application Object	18
3.4	Default PDO Mapping	19
3.5	EMCY Communication	20
	Appendix A: Dimension.....	21
	Appendix B: Type Code Definition	22

1 Introduction

1.1 Overview

CANopen is one kind of the network protocols based on the CAN bus and mainly used for embedded network system, such as industrial machine control, vehicle control system, factory automation, medical equipments control, remote data acquisition, environmental monitoring, and packaging machines control, etc.

The CAN-2017C module follows the CiA DS-301 version 4.02 and DSP-401 version 2.1. It is easy to access the differential analog input status and set the configuration by using the standard CANopen protocol. The CAN-2017C has passed the validation of the CiA CANopen Conformance Test tool. Therefore, the provided EDS file is standard for any other standard CANopen masters. By using the 8-channel analog input and the CANopen masters of ICP DAS, you can quickly build a CANopen network to approach your requirements.



1.2 Hardware Specifications

Analog Input:

- Input Channels: 8
- Input Type: $\pm 10\text{V}$, $\pm 5\text{V}$, $\pm 1\text{V}$, $\pm 500\text{mV}$, $\pm 150\text{mV}$, $-20\text{mA} \sim +20\text{mA}$
(External 125Ω Resistor is Required)
- Resolution: 16-bit
- Accuracy: $\pm 0.1\%$ FSR
- Sampling Rate: 10 Samples/ sec (Total)
- Zero Drift: $\pm 10\mu\text{V}/^\circ\text{C}$
- Span Drift: ± 25 ppm/ $^\circ\text{C}$
- Common Mode Rejection: 86 dB
- Normal Mode Rejection: 100 dB
- Input Impedance: $>2\text{ M}\Omega$
- Over-voltage Protection: 240 Vrms
- Individual Channel Configuration: Yes
- Intra-module Isolation, Field to Logic: $3000\text{ V}_{\text{DC}}$
- ESD Protection: $\pm 4\text{ kV}$ Contact for each terminal.

Others:

- Power LED: PWR (red)
- CANopen Status LED: RUN (green) / ERR (orange)
- 8 LEDs as Upper Limit Alarm Indicators
- 8 LEDs as Lower Limit Alarm Indicators
- Power Supply: Unregulated $+10 \sim +30\text{ V}_{\text{DC}}$.
- Power Consumption: 2 W.
- Operating Temperature: $-25 \sim +75\text{ }^\circ\text{C}$.
- Storage Temperature: $-30 \sim +80\text{ }^\circ\text{C}$.
- Humidity: 10 to 90% RH, Non-condensing.
- Dimensions: 33 mm x 99 mm x 78 mm (W x L x H) [Detail](#).

1.3 Features

- Standard CANopen general I/O slave devices.
- CANopen Version: DS-301, v4.02.
- Device Profile: DSP-401, v2.1
- Provide 8 differential analog input channels.
- CANopen transfer rate: 10 kbps, 20 kbps, 50 kbps, 125 kbps, 250 kbps, 500 kbps, 800 kbps, 1000 kbps.
- Maximum CANopen slave Node-ID up to 99.
- Support NMT, PDO, SDO, EMCY, SYNC, Guarding, and Heartbeat protocol.
- Pass the validation of the CANopen Conformance Test
- Provide EDS file for the CANopen master interfaces

1.4 Application

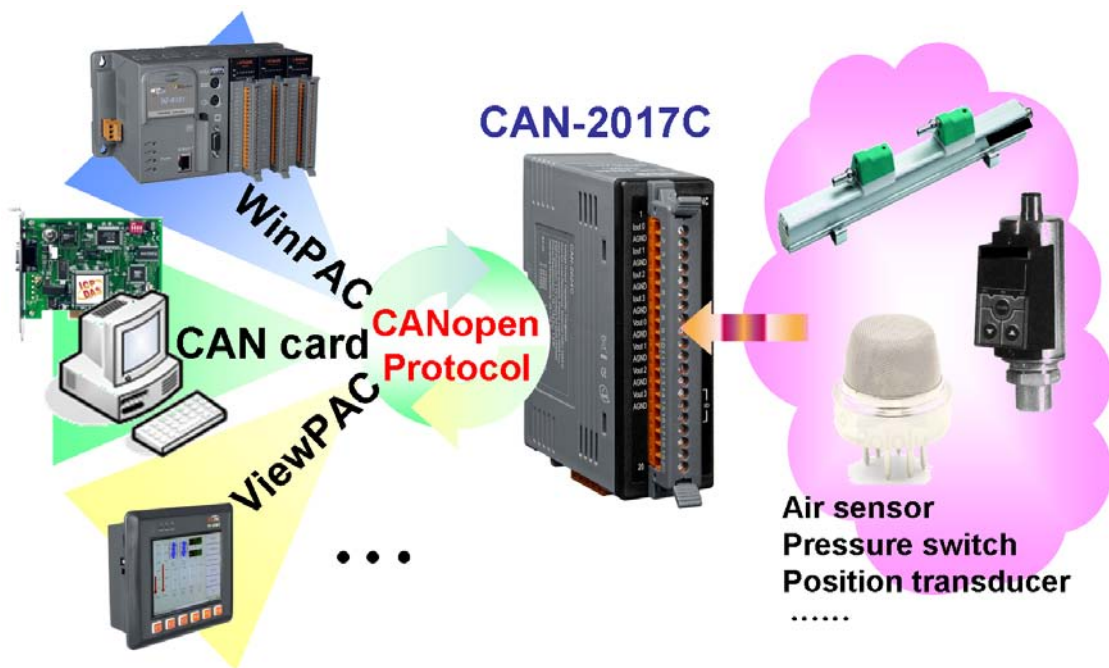

2 Hardware

2.1 Structure

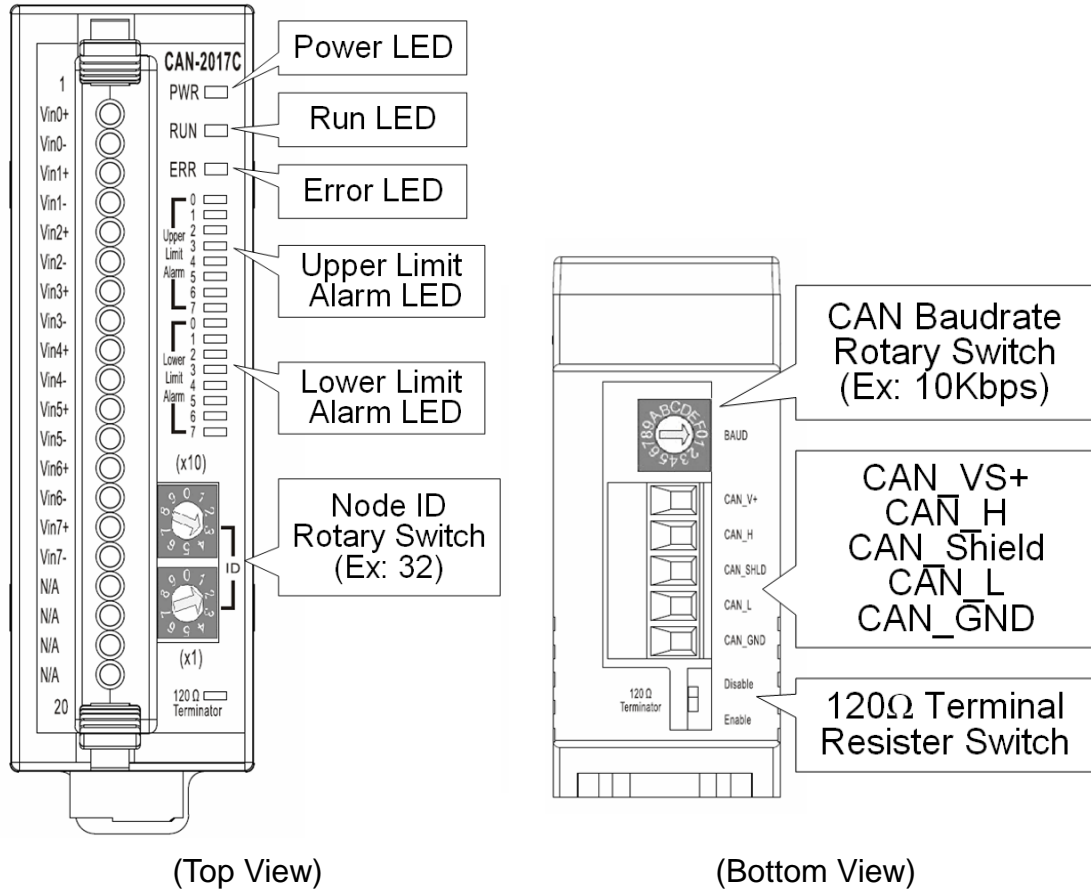

2.2 Node ID & Baud Rate Rotary Switch

The rotary switches for node ID configure the node ID of the CAN-2017C module. These two switches are for the tens digit and the units digit of node ID. The node ID value of this demo picture is 32.

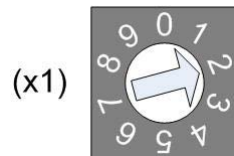
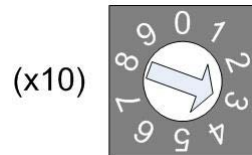

Node ID rotary switch

The rotary switch for baud rate handles the CAN baud rate of the CAN-2017C module. The relationship between the rotary switch value and the practical baud rate is presented in the following table.



Baud rate rotary switch

Rotary Switch Value	Baud rate (k BPS)
0	10
1	20
2	50
3	125
4	250
5	500
6	800
7	1000

Baud rate and rotary switch

2.3 LED Description

Power LED

The CAN-2017C needs a 10 ~ 30 V_{DC} power supply. Under a normal connection, a good power supply and a correct voltage selection, as the unit is turned on, the LED will be lighted up in red.

Run LED

The Run LED indicates the CANopen operation state. The description of the LED state is shown below. About the details, please refer to the section 2.3.1 of the CAN-2000C user manual.

LED Signal	State	Description
OFF	No power	Power Supply is not ready
Single Flash	Stopped	The device is in Stopped state
Blinking	Pre-operation	Device is in pre-operational state
Always ON	Operation	Device is in operational state

Error LED

The Error LED indicates the CANopen error state. The description of the LED state is shown below. About the details, please refer to the section 2.3.2 of the CAN-2000C user manual.

LED Signal	State	Description
OFF	No error	Device is in working condition.
Single Flash	Error Warning	At least one error of the CAN controller has occurred.
Double Flash	Guarding fail.	Guard event happened.
Always ON	Bus Off	The CAN controller is bus off.





















Terminal Resistor LED

When the switch of the 120Ω terminator resistor is turned on, the terminal resistor LED will be lightening.

Upper/Lower Limit Alarm LED

First all, the “Analog Input global interrupt enable(SDO: 6423h)” must be enabled. If the analog input is more or less than the value of the “Analog Input global interrupt Upper/Lower Limit Integer(SDO: 6424h/6425h)” of the channel, the Upper/Lower Limit Alarm LED of the channel will be lightening.

2.4 PIN Assignment

Terminal No.	Pin Assignment
 01	Vin 0 +
 02	Vin 0 -
 03	Vin 1 +
 04	Vin 1 -
 05	Vin 2 +
 06	Vin 2 -
 07	Vin 3 +
 08	Vin 3 -
 09	Vin 4 +
 10	Vin 4 -
 11	Vin 5 +
 12	Vin 5 -
 13	Vin 6 +
 14	Vin 6 -
 15	Vin 7 +
 16	Vin 7 -
 17	N/A
 18	N/A
 19	N/A
 20	N/A

CAN-2017C 20-pin Connector

2.5 Wire Connection

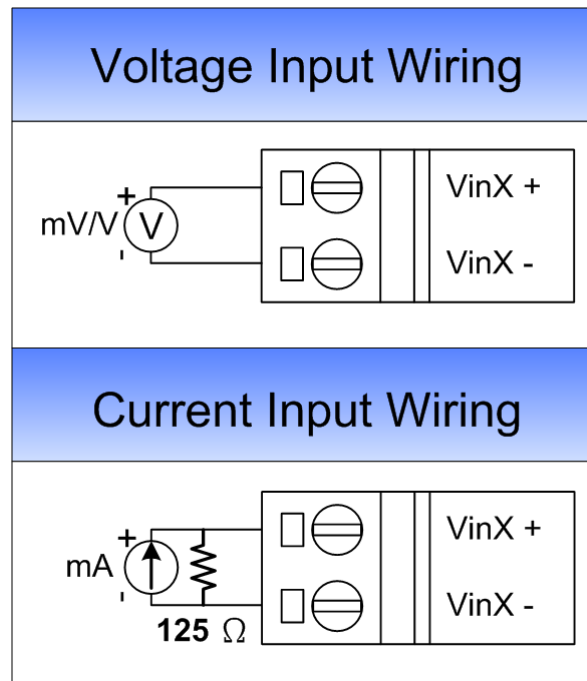

3 Application

3.1 Object Dictionary

General Communication Entries

Idx	Sidx	Description	Type	Attr	Default
1000h	0h	device type	UNSIGNED 32	RO	00040191h
1001h	0h	error register	UNSIGNED 8	RO	0h
1003h	0h	largest subindex supported for "predefine error field"	UNSIGNED 8	RO	0h
	1h	actual error (the newest one)	UNSIGNED 32	RO	---
	---
	5h	actual error (the oldest one)	UNSIGNED 32	RO	---
1005h	0h	COB-ID of Sync message	UNSIGNED 32	RW	80h
1008h	0h	manufacturer device name	VISIBLE_STRING	RO	CAN-2017C
1009h	0h	manufacturer hardware version	VISIBLE_STRING	RO	1.2
100Ah	0h	manufacturer software version	VISIBLE_STRING	RO	1.00-20111101
100Ch	0h	guard time	UNSIGNED 16	RW	0h
100Dh	0h	life time factor	UNSIGNED 8	RW	0h
1010h	0h	largest subindex supported for "store parameters"	UNSIGNED 8	RO	1h
1010h	1h	save all hardware parameter	UNSIGNED 32	RW	---
1011h	0h	largest subindex supported for "restore default parameters"	UNSIGNED 8	RO	1h
1011h	1h	restore all default parameters	UNSIGNED 32	RW	---
1014h	0h	COB-ID of EMCY	UNSIGNED 32	RW	80h+x
1015h	0h	Inhibit time of EMCY	UNSIGNED 16	RW	0h
1017h	0h	producer heartbeat time	UNSIGNED 16	RW	0h
1018h	0h	largest subindex supported for "identity object"	UNSIGNED 8	RO	4h
	1h	vender ID	UNSIGNED 32	RO	0000013Ch
	2h	product code	UNSIGNED 32	RO	00002017h
	3h	revision number	UNSIGNED 32	RO	---
	4h	serial number	UNSIGNED 32	RO	---

Note: x is Node-ID of the module

SDO Communication Entries

Idx	Sidx	Description	Type	Attr	Default
1200h	0h	largest subindex supported for "server SDO parameter"	UNSIGNED 8	RO	2
	1h	COB-ID form client to server (RxSDO)	UNSIGNED 32	RO	600h+x
	2h	COB-ID form server to client (TxSDO)	UNSIGNED 32	RO	580h+x

Note: x is Node-ID of the module

RxPDO Communication Entry

Idx	Sidx	Description	Type	Attr	Default
1400h	0h	Number of entries	UNSIGNED 8	RO	2
	1h	COB-ID used by RxPDO	UNSIGNED 32	RW	200h+x
	2h	Transmission type	UNSIGNED 8	RW	FFh
1401h	0h	Number of entries	UNSIGNED 8	RO	2
	1h	COB-ID used by RxPDO	UNSIGNED 32	RW	300h+x
	2h	Transmission type	UNSIGNED 8	RW	FFh
1402h	0h	Number of entries	UNSIGNED 8	RO	2
	1h	COB-ID used by RxPDO	UNSIGNED 32	RW	400h+x
	2h	Transmission type	UNSIGNED 8	RW	FFh
1403h	0h	Number of entries	UNSIGNED 8	RO	2
	1h	COB-ID used by RxPDO	UNSIGNED 32	RW	500h+x
	2h	Transmission type	UNSIGNED 8	RW	FFh
1404h	0h	Number of entries	UNSIGNED 8	RO	2
	1h	COB-ID used by RxPDO	UNSIGNED 32	RW	C000 0000h
	2h	Transmission type	UNSIGNED 8	RW	---
...
1409h	0h	Number of entries	UNSIGNED 8	RO	2
	1h	COB-ID used by RxPDO	UNSIGNED 32	RW	C000 0000h
	2h	Transmission type	UNSIGNED 8	RW	---

Note: x is Node-ID of the module

RxPDO Mapping Communication Entry

Idx	Sidx	Description	Type	Attr	Default
1600h	0h	Number of entries	UNSIGNED 8	RW	0
1601h	0h	Number of entries	UNSIGNED 8	RW	0
1602h	0h	Number of entries	UNSIGNED 8	RW	0
...
1609h	0h	Number of entries	UNSIGNED 8	RW	0

TxPDO Communication Entry

Idx	Sidx	Description	Type	Attr	Default
1800h	0h	Number of entries	UNSIGNED 8	RO	5
	1h	COB-ID used by TxPDO	UNSIGNED 32	RW	180h+x
	2h	Transmission type	UNSIGNED 8	RW	FFh
	3h	Inhibit time	UNSIGNED 16		0
	4h	Reversed	---	---	---
	5h	Event timer	UNSIGNED 16		0
1801h	0h	Number of entries	UNSIGNED 8	RO	5
	1h	COB-ID used by TxPDO	UNSIGNED 32	RW	280h+x
	2h	Transmission type	UNSIGNED 8	RW	FFh
	3h	Inhibit time	UNSIGNED 16		0
	4h	Reversed	---	---	---
	5h	Event timer	UNSIGNED 16		0
1802h	0h	Number of entries	UNSIGNED 8	RO	5
	1h	COB-ID used by TxPDO	UNSIGNED 32	RW	380h+x
	2h	Transmission type	UNSIGNED 8	RW	FFh
	3h	Inhibit time	UNSIGNED 16		0
	4h	Reversed	---	---	---
	5h	Event timer	UNSIGNED 16		0
1803h	0h	Number of entries	UNSIGNED 8	RO	5
	1h	COB-ID used by TxPDO	UNSIGNED 32	RW	480h+x
	2h	Transmission type	UNSIGNED 8	RW	FFh
	3h	Inhibit time	UNSIGNED 16		0
	4h	Reversed	---	---	---
	5h	Event timer	UNSIGNED 16		0
1804h	0h	Number of entries	UNSIGNED 8	RO	5
	1h	COB-ID used by TxPDO	UNSIGNED 32	RW	8000 0000h
	2h	Transmission type	UNSIGNED 8	RW	---

	3h	Inhibit time	UNSIGNED 16		0
	4h	Reversed	---	---	---
	5h	Event timer	UNSIGNED 16		0
...
1809h	0h	Number of entries	UNSIGNED 8	RO	5
	1h	COB-ID used by TxPDO	UNSIGNED 32	RW	8000 0000h
	2h	Transmission type	UNSIGNED 8	RW	---
	3h	Inhibit time	UNSIGNED 16		0
	4h	Reversed	---	---	---
	5h	Event timer	UNSIGNED 16		0

Note: x is Node-ID of the module

TxPDO Mapping Communication Entry

Idx	Sidx	Description	Type	Attr	Default
1A00h	0h	Number of entries	UNSIGNED 8	RO	0
1A01h	0h	Number of entries	UNSIGNED 8	RO	4
	1h	AI value of channel 0	UNSIGNED 32	RW	6401 0110h
	2h	AI value of channel 1	UNSIGNED 32	RW	6401 0210h
	3h	AI value of channel 2	UNSIGNED 32	RW	6401 0310h
	4h	AI value of channel 3	UNSIGNED 32	RW	6401 0410h
1A02h	0h	Number of entries	UNSIGNED 8	RO	4
	1h	AI value of channel 4	UNSIGNED 32	RW	6401 0510h
	2h	AI value of channel 5	UNSIGNED 32	RW	6401 0610h
	3h	AI value of channel 6	UNSIGNED 32	RW	6401 0710h
	4h	AI value of channel 7	UNSIGNED 32	RW	6401 0810h
1A03h	0h	Number of entries	UNSIGNED 8	RO	0
1A04h	0h	Number of entries	UNSIGNED 8	RO	0
1A05h	0h	Number of entries	UNSIGNED 8	RO	0
...
1A09h	0h	Number of entries	UNSIGNED 8	RO	0

AI Channel Type Code Function

Idx	Sidx	Description	Type	Attr	Default
2004h	0h	Number of entries	UNSIGNED 8	RO	8
	1h	AI type code of channel 0	UNSIGNED 8	RW	8

	8h	AI type code of channel 7	UNSIGNED 8	RW	8

Note: Please refer to “Appendix B” for all supported AI type code

Analog Input Function

Idx	Sidx	Description	Type	Attr	Default
6401h	0h	Number of entries	UNSIGNED 8	RO	8
	1h	The AI value of channel 0	INTEGER 16	RO	--

	8h	The AI value of channel 7	INTEGER 16	RO	--

Note: Please refer to “Appendix B” for AI value range

When the “AI global interrupt trigger enable(SDO: 6423h)” is enabled, CAN-2017C will start to feedback the TxPDO while the AI value reaches the conditions configured in the “AI interrupt trigger selection(SDO: 6421h).” Users can set up the upper limit, lower limit, and the delta for each AI channel by SDO: 6424h, 6425h and 6426h.

Analog Input Global Interrupt Trigger Enable

Idx	Sidx	Description	Type	Attr	Default
6423h	0h	Analog Input Global Interrupt Trigger Enable	Boolean	RW	0

Analog Input Interrupt Trigger Selection

Idx	Sidx	Description	Type	Attr	Default
6421h	0h	Number of entries	UNSIGNED 8	RO	8
	1h	AI interrupt trigger selection of channel 0	UNSIGNED 8	RW	7

	8h	AI interrupt trigger selection of channel 0	UNSIGNED 8	RW	7

Bit no.	Analog interrupt trigger selection
0	The AI value exceeds the upper limit
1	The AI value is less than the lower limit
2	The change of the AI value is more than the delta
3 to 7	Reversed

If you set the bit 0 of the interrupt trigger selection to 1, the CAN-2017C would feedback the AI value automatically while this AI value exceeds the upper limit. The eight Upper/Lower Limit Alarm Indicators on the panel of

CAN-2017C will be lightening respectively. By the way, if AI upper limit or lower limit leads CAN-2017C to send too many TxPDO messages in a quite short time, you could modify the Inhibit time of the TxPDO. It will change the minimum period between the consequent CAN messages, and the bigger Inhibit time value you set, the longer time period between the two TxPDO messages you get.

Analog Input Interrupt Upper Limit Integer

Idx	Sidx	Description	Type	Attr	Default
6424h	0h	Number of entries	UNSIGNED 8	RO	8
	1h	AI upper limit of channel 0	INTEGER 32	RW	--

	8h	AI upper limit of channel 7	INTEGER 32	RW	--

Note: Please refer to “Appendix B” for AI upper limit range

Analog Input Interrupt Lower Limit Integer

Idx	Sidx	Description	Type	Attr	Default
6425h	0h	Number of entries	UNSIGNED 8	RO	8
	1h	AI lower limit of channel 0	INTEGER 32	RW	--

	8h	AI lower limit of channel 7	INTEGER 32	RW	--

Note: Please refer to “Appendix B” for AI lower limit range

Analog Input Interrupt Delta Unsigned

Idx	Sidx	Description	Type	Attr	Default
6426h	0h	Number of entries	UNSIGNED 8	RO	8
	1h	AI delta value of channel 0	UNSIGNED 32	RW	3E8h

	8h	AI delta value of channel 7	UNSIGNED 32	RW	3E8h

Note: These values are used to define the acceptable AI change ranges for each AI channels. The default for these values is 1000, and may have different range for the physical value because of the settings of the type code. Please refer to the appendix B for the type code definition.

3.2 Store and Restore Object

The users can write the value 65766173h to object with index 1010h and subindex 1 to save the application setting, or write the value 64616F6Ch to object with index 1011h and subindex 1 and reboot the module to load the factory default. The following table lists the relative objects which will be stored or restored after writing these two objects. The factory default for these objects is also shown below.

Index	Sub Index	Description	Factory Default
2004 h	1 ~ 8	AI type codes for channel 0~ 7	08h
6421	1 ~ 8	AI interrupt trigger selections for channel 0 ~ 7	07h
6423	0	AI global interrupt enable	0
6424	1 ~ 8	AI interrupt upper limits for channel 0 ~ 7	7FFFh
6425	1 ~ 8	AI interrupt lower limits for channel 0 ~ 7	E99Ah
6426	1 ~ 8	AI interrupt delta vlues for channel 0 ~ 7	3E8h
1400h	1 ~ 2	RxPDO1 parameter	--
...
1409h	1 ~ 2	RxPDO10 parameter	--
1600h	0 ~ 8	RxPDO1 mapping information	--
...
1609h	0 ~ 8	RxPDO10 mapping information	--
1800h	1 ~ 5	TxPDO1 parameter	--
...
1809h	1 ~ 5	TxPDO10 parameter	--
1A00h	0 ~ 8	TxPDO1 mapping information	--
...
1A09h	0 ~ 8	TxPDO10 mapping information	--

3.3 Application Object

The users can read the object with index 6401h and subindex 1 ~ 8 to get the analog value of the channel 0 ~ 7, and the range for each AI type codes are listed in Appendix B. If the users wants to change the analog input type, write the type code to the object with index 2004h and subindex 1 ~ 8. For example, if the node ID of CAN-2017C is 1, the following command would be used:

11-bit COB-ID (bit)											RTR	Data Lengt h	8-byte Data (byte)							
Func Code				Node ID									0	1	2	3	4	5	6	7
10	9	8	7	6	5	4	3	2	1	0										
1	1	0	0	0	0	0	0	0	0	1	0	8	2F	04	20	01	09	00	00	00

SDO client



**SDO server
(CAN-2017C)**

11-bit COB-ID (bit)											RTR	Data Length	8-byte Data (byte)							
Func Code				Node ID									0	1	2	3	4	5	6	7
10	9	8	7	6	5	4	3	2	1	0										
1	0	1	1	0	0	0	0	0	0	1	0	4	60	04	20	01	--	--	--	--

SDO client



**SDO server
(CAN-2017C)**

Writing object with index 2004h and subindex 1 with 09h means to change the type code of the AI channel 0 with 09h (the AI measurement range is -5V ~ +5V).

11-bit COB-ID (bit)											RTR	Data Lengt h	8-byte Data (byte)							
Func Code				Node ID									0	1	2	3	4	5	6	7
10	9	8	7	6	5	4	3	2	1	0										
1	1	0	0	0	0	0	0	0	0	1	0	8	40	01	64	01	00	00	00	00

SDO client



**SDO server
(CAN-2017C)**

11-bit COB-ID (bit)											RTR	Data Lengt h	8-byte Data (byte)							
Func Code				Node ID									0	1	2	3	4	5	6	7
10	9	8	7	6	5	4	3	2	1	0										
1	0	1	1	0	0	0	0	0	0	1	0	4	4B	01	64	01	FF	3F	--	--

SDO client



**SDO server
(CAN-2017C)**

Reading object with index 6401h and subindex 1 means to get the value of the AI channel 0. According to the type code 09h set before, the replied value of the AI channel 0 is 3FFFh (+2.5V).

3.4 Default PDO Mapping

RxPDO mapping list:

ID	Len	D 0	D 1	D 2	D 3	D 4	D 5	D 6	D 7
200h + x	0	Reserved							
300h + x	0	Reserved							
400h + x	0	Reserved							
500h + x	0	Reserved							

TxPDO mapping list:

ID	Len	D 0	D 1	D 2	D 3	D 4	D 5	D 6	D 7
180h + x	0	Reserved							
280h + x	8	AI ch0		AI ch1		AI ch2		AI ch3	
380h + x	8	AI ch4		AI ch5		AI ch6		AI ch7	
480h + x	0	Reserved							

3.5 EMCY Communication

The data format of the emergency object data follows the structure bellows.

Byte	0	1	2	3	4	5	6	7
Content	Emergency Error Code		Error register	Manufacturer specific Error Field				

Each bit on the error register is defined as follows.

Bit	Meaning
0	generic error
1	current
2	voltage
3	temperature
4	communication error (overrun, error state)
5	device profile specific
6	reserved (always 0)
7	manufacturer specific

The emergency error codes and the error register are specified in the following table.

Emergency Error Code		Error Register	Manufacturer Specific Error Field		Description	
High Byte	Low Byte		First Byte	Last Four Bytes		
00	00	00	00	00 00 00 00	Error Reset or No Error	
10	00	81	01	00 00 00 00	CAN Controller Error Occur	
50	00	81	02	00 00 00 00	EEPROM Access Error	
81	10	11	04	00 00 00 00	Soft Rx Buffer Overrun	
81	10	11	05	00 00 00 00	Soft Tx Buffer Overrun	
81	10	11	06	00 00 00 00	CAN Controller Overrun	
81	30	11	07	00 00 00 00	Lift Guarding Fail	
81	40	11	08	00 00 00 00	Recover From Bus Off	
82	10	11	09	00 00 00 00	PDO Data Length Error	
FF	00	80	0A	00 00 00 00	Request To Reset Node Or Communication	
FF	00	2E	0B	00 00 Upper limit alarm	00 00 Low limit alarm	Upper/Low Limit Alarm For Each Channel

Appendix A: Dimension

CAN-2017C dimension:

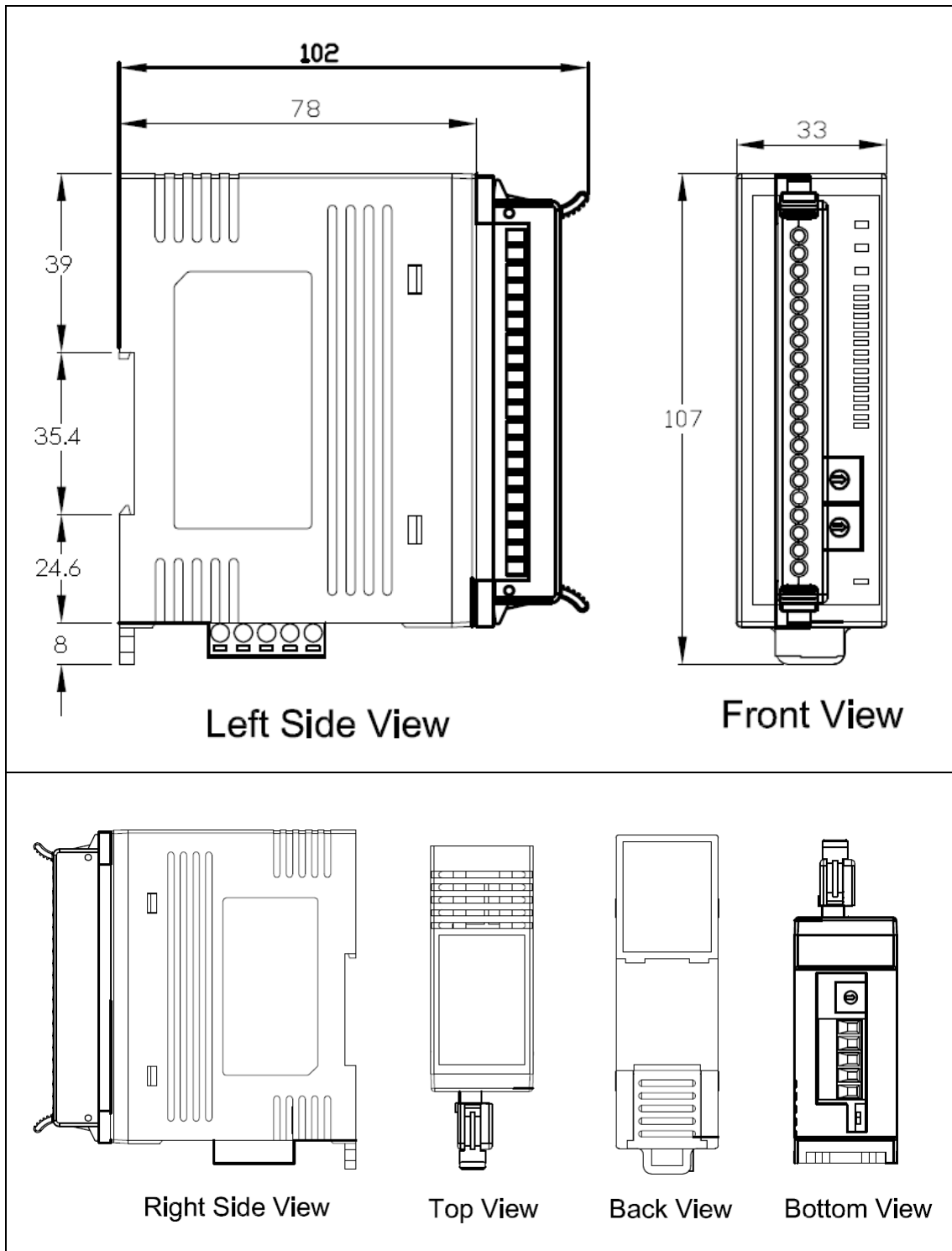

Unit: mm

Appendix B: Type Code Definition

Type Code Definition for CAN-2017C

Type Code	Input Range	Data Format	Min Value	Max Value
08h	-10 to +10V	Engineer Unit	-10V	+10V
		2's Complement HEX	8000h	7FFFh
09h	-5 to +5V	Engineer Unit	-5V	+5V
		2's Complement HEX	8000h	7FFFh
0Ah	-1 to +1V	Engineer Unit	-1V	+1V
		2's Complement HEX	8000h	7FFFh
0Bh	-500 to +500 mV	Engineer Unit	-500mV	+500mV
		2's Complement HEX	8000h	7FFFh
0Ch	-150 to +150 mV	Engineer Unit	-150mV	+150mV
		2's Complement HEX	8000h	7FFFh
0Dh	-20 to +20 mA (with 125 Ω resistor)	Engineer Unit	-20mA	+20mA
		2's Complement HEX	8000h	7FFFh