ARES-1980 Series

**Fanless Rugged Controller with 11th Gen.
Intel® Core™ i7/i5/i3 Processor**

User's Manual

Version 1.1

Revision History

Version	Date	Description
1.0	2021.12	Initial release
1.1	2023.01	- Revise connector type of (21) IO1 on page 21 - Add 2.2.4. Top Side View and 2.2.5 LED Indicator Status

Revision History	ii
Contents	i
Preface.....	iii
Copyright Notice	iii
Declaration of Conformity	iii
CE.....	iii
FCC Class A	iii
RoHS	iv
SVHC / REACH	iv
Important Safety Instructions	v
Warning.....	vi
Lithium Battery Replacement.....	vi
Technical Support	vi
Warranty.....	vii
Chapter 1 - Introduction.....	1
1.1. Features.....	2
1.2. About this Manual	2
1.3. Specifications.....	3
1.3. Inside the Package	5
Chapter 2 - Getting Started.....	7
2.1. Dimensions	8
2.2. Overview	9
2.2.1. Front View	9
2.2.2. Left Side View	9
2.2.3. Right Side View	10
2.2.4. Top Side View	10
2.2.5. LED Indicator Status.....	11
2.3. Driver Installation Note	11
Chapter 3 - Engine of the Computer.....	13
3.1. Boards Overview.....	14
3.2. Connectors	16
Chapter 4 - Installation and Maintenance.....	23
4.1. Disassembling and Assembling the Computer	24
4.1.1. Disassembling the Computer.....	24
4.1.2. Assembling the Computer.....	25
4.2. Installing Hardware	26
4.2.1. Installing Memory Module.....	26
4.2.2. Installing/Replacing a SSD or HDD	28
4.2.3. Installing M.2 Module.....	30
4.2.4. Installing Encryption Dongle	31

- 4.2.5. Install/uninstall SIM Card and relative connection module . 32
- 4.3. Mounting
 - 4.3.1 DIN-Rail Mounting
 - 4.2.6. Install/uninstall WI-FI connection module 35
- Chapter 5 - BIOS 39**
 - 5.1. Main 42
 - 5.2. Advanced 43
 - 5.2.1. CPU Configuration 44
 - 5.2.2. Power & Performance 45
 - 5.2.3. Trusted Computing 48
 - 5.2.4. ACPI Settings 50
 - 5.2.5. F81966 Super IO Configuration 51
 - 5.2.6. Hardware Monitor 52
 - 5.2.7. S5 RTC Wake Settings 53
 - 5.2.8. Serial Port Console Redirection 54
 - 5.2.9. USB Configuration 55
 - 5.2.10. Network Stack Configuration 57
 - 5.2.11. NVME Configuration 58
 - 5.3. Chipset 59
 - 5.3.1. System Agent (SA) Configuration 60
 - 5.3.2. PCH-IO Configuration 63
 - 5.4. Security 66
 - 5.4.1 Security Boot 67
 - 5.5. Boot 68
 - 5.6. Save & Exit 70
- Appendix 71**
 - Appendix A. 16-bit DIO Signal Connections 72
 - A.1. Isolated Digital Input Connections 72
 - A.2. Isolated Digital Output Connections 73

Copyright Notice

All Rights Reserved.

The information in this document is subject to change without prior notice in order to improve the reliability, design and function. It does not represent a commitment on the part of the manufacturer.

Under no circumstances will the manufacturer be liable for any direct, indirect, special, incidental, or consequential damages arising from the use or inability to use the product or documentation, even if advised of the possibility of such damages.

This document contains proprietary information protected by copyright. All rights are reserved. No part of this document may be reproduced by any mechanical, electronic, or other means in any form without prior written permission of the manufacturer.

Declaration of Conformity

CE

The CE symbol on your product indicates that it is in compliance with the directives of the Union European (EU). A Certificate of Compliance is available by contacting Technical Support.

This product has passed the CE test for environmental specifications when shielded cables are used for external wiring. We recommend the use of shielded cables. This kind of cable is available from ARBOR. Please contact your local supplier for ordering information.

Warning

This is a class A product. In a domestic environment this product may cause radio interference in which case the user may be required to take adequate measures.

FCC Class A

This device complies with Part 15 of the FCC Rules. Operation is subject to the following two conditions:

- (1) This device may not cause harmful interference, and
- (2) This device must accept any interference received, including interference that may cause undesired operation.

NOTE:

This equipment has been tested and found to comply with the limits for a Class A digital device, pursuant to Part 15 of the FCC Rules. These limits are designed to provide reasonable protection against harmful interference when the equipment is operated in a commercial environment. This equipment generates, uses, and can radiate radio frequency energy and, if not installed and used in accordance with the instruction manual, may cause harmful interference to radio communications. Operation of this equipment in a residential area is likely to cause harmful interference in which case the user will be required to correct the interference at his own expense.

RoHS

ARBOR Technology Corp. certifies that all components in its products are in compliance and conform to the European Union's Restriction of Use of Hazardous Substances in Electrical and Electronic Equipment (RoHS) Directive 2002/95/EC.

The above mentioned directive was published on 2/13/2003. The main purpose of the directive is to prohibit the use of lead, mercury, cadmium, hexavalent chromium, polybrominated biphenyls (PBB), and polybrominated diphenyl ethers (PBDE) in electrical and electronic products. Member states of the EU are to enforce by 7/1/2006.

ARBOR Technology Corp. hereby states that the listed products do not contain unintentional additions of lead, mercury, hex chrome, PBB or PBDB that exceed a maximum concentration value of 0.1% by weight or for cadmium exceed 0.01% by weight, per homogenous material. Homogenous material is defined as a substance or mixture of substances with uniform composition (such as solders, resins, plating, etc.). Lead-free solder is used for all terminations (Sn(96-96.5%), Ag(3.0-3.5%) and Cu(0.5%)).

SVHC / REACH

To minimize the environmental impact and take more responsibility to the earth we live, Arbor hereby confirms all products comply with the restriction of SVHC (Substances of Very High Concern) in (EC) 1907/2006 (REACH --Registration, Evaluation, Authorization, and Restriction of Chemicals) regulated by the European Union.

All substances listed in SVHC < 0.1 % by weight (1000 ppm)

Important Safety Instructions

Read these safety instructions carefully

1. Read all cautions and warnings on the equipment.
2. Place this equipment on a reliable surface when installing. Dropping it or letting it fall may cause damage
3. Make sure the correct voltage is connected to the equipment.
4. For pluggable equipment, the socket outlet should be near the equipment and should be easily accessible.
5. Keep this equipment away from humidity.
6. The openings on the enclosure are for air convection and protect the equipment from overheating. **DO NOT COVER THE OPENINGS.**
7. Position the power cord so that people cannot step on it. Do not place anything over the power cord.
8. Never pour any liquid into opening. This may cause fire or electrical shock.
9. Never open the equipment. For safety reasons, the equipment should be opened only by qualified service personnel.
10. If one of the following situations arises, get the equipment checked by service personnel:
 - a. The power cord or plug is damaged.
 - b. Liquid has penetrated into the equipment.
 - c. The equipment has been exposed to moisture.
 - d. The equipment does not work well, or you cannot get it to work according to the user's manual.
 - e. The equipment has been dropped or damaged.
 - f. The equipment has obvious signs of breakage.
11. Keep this User's Manual for later reference.

Warning

The Box PC and its components contain very delicately Integrated Circuits (IC). To protect the Box PC and its components against damage caused by static electricity, you should always follow the precautions below when handling it:

1. Disconnect your Box PC from the power source when you want to work on the inside.
2. Use a grounded wrist strap when handling computer components.
3. Place components on a grounded antistatic pad or on the bag that came with the Box PC, whenever components are separated from the system.

Lithium Battery Replacement

Incorrect replacement of the lithium battery may lead to a risk of explosion.

The lithium battery must be replaced with an identical battery or a battery type recommended by the manufacturer.

Do not throw lithium batteries into the trash can. It must be disposed of in accordance with local regulations concerning special waste.

Technical Support

If you have any technical difficulties, please consult the user's manual first at:
<https://www.arbor-technology.com>

Please do not hesitate to call or e-mail our customer service when you still cannot find out the answer.

<https://www.arbor-technology.com>

E-mail: info@arbor.com.tw

Warranty

This product is warranted to be in good working order for a period of one year from the date of purchase. Should this product fail to be in good working order at any time during this period, we will, at our option, replace or repair it at no additional charge except as set forth in the following terms. This warranty does not apply to products damaged by misuse, modifications, accident or disaster.

Vendor assumes no liability for any damages, lost profits, lost savings or any other incidental or consequential damage resulting from the use, misuse of, or inability to use this product. Vendor will not be liable for any claim made by any other related party.

Vendors disclaim all other warranties, either expressed or implied, including but not limited to implied warranties of merchantability and fitness for a particular purpose, with respect to the hardware, the accompanying product's manual(s) and written materials, and any accompanying hardware. This limited warranty gives you specific legal rights.

Return authorization must be obtained from the vendor before returned merchandise will be accepted. Authorization can be obtained by calling or faxing the vendor and requesting a Return Merchandise Authorization (RMA) number. Returned goods should always be accompanied by a clear problem description.

This page is intentionally left blank.

Chapter 1

Introduction

1.1. Features

- Onboard Intel® Core™ i Processor (Tiger Lake UP3)
- Support 2 x 260-pin DDR4 SO-DIMM sockets
- Support 5G (Sub-6G) module, M.2 NVMe SSD Gen3x4, USB 3.2 Gen2, and 2.5 GbE LAN
- Rich I/O: 4 x COM/ 3 x 2.5GbE LAN/ 4 x USB3.2 Gen 2/ Remote control PWR
- Support Triple-display (DVI-D/HDMI/DP)
- Wide Power Input: 9~36 VDC
- Power on/off delay control / configurable ignition power control
- Support DirectX 12

1.2. About this Manual

This manual is meant for the experienced users and integrators with hardware knowledge of personal computers. If you are not sure about the description in this manual, consult your vendor before further handling.

We recommend that you keep one copy of this manual for the quick reference for any necessary maintenance in the future. Thank you for choosing ARBOR products.

1.3. Specifications

System	
CPU	Soldered onboard Intel® i7/ i5/ i3 Processor (Default: i5 CPU Tiger Lake-U)
Memory	2 x 260-pin DDR4 SO-DIMM sockets, supporting 3200MHz SDRAM up to 64GB
Chipset	SoC
Graphics	Intel® Iris® Xe Graphics
LAN Chipset	2 x Intel® i211AT PCIe controller 1 x Intel® 225LM PCIe controller
Watchdog Timer	1~255 levels reset
I/O	
Serial Port	2 x RS232 (DB-9 male connector) 2 x RS232(Default)/422/485 (RI/5V/12V) (DB-9 male connector/ Switch via BIOS)
USB Port	4 x USB-A 3.2 Gen2 (2 w/ independent full speed) 1 x USB-A 2.0 onboard for encryption dongle (Type A)
LAN	2 x RJ-45 ports for GbE LAN (PoE complies with IEEE802.3af) 1 x RJ-45 ports for 2.5 GbE LAN (iAMT support w/ i5/i7 skus)
Video Port	1 x HDMI 2.0b, up to 3840x2160@60Hz
	1 x DisplayPort 1.4, up to 3840x2160@60Hz
	1 x DVI-D, up to 1920x1080@60Hz
Audio	1 x Mic-in & 1 x Line out
Expansion Bus	1 x full mPCIe slot (PCIe x1+ USB2.0, Full size) w/ 1 x nano SIM card slot
	1 x M.2 B-Key 2242/3042/3052 (PCIe x2 + USB3.0) w/ 2 x nano SIM card slots supporting 5G/LTE module
	1 x M.2 E-Key 2230 (CNVi + USB 2.0) slot for WiFi /BT **Support CNVi modules only**
Digital I/O	8 x DI & 8 x DO w/ 1.5KV isolation
Multi-Serial Bus	I ² C/SPI/UART/GPIO (w/ 3.3 or 5V) via DB-26
Others	10 x Antenna Holes are reserved

Storage	
Type	1 x M.2 M-Key 2242/2280 (PCIe Gen III x4 + SATAIII)
	1 x 2.5" HDD/SSD tray (SATA III + SATA PWR connector)
Environmental	
Operating Temp.	-20 ~ 60°C (-4 ~ 140°F), ambient w/ air flow
Storage Temp.	-40 ~ 70°C (-40 ~ 158°F)
Operating Humidity	10-95% @ 60°C (non-condensing)
Vibration	5~500Hz 3 Grms X,Y,Z axis w/ SSD, according to IEC 60068-2-64
Shock	40G peak acceleration (11 m sec. duration), operation w/ SSD
	80G peak acceleration (11 m sec. duration), nonoperation w/ SSD
	According to IEC 60068-2-27
Qualification	
Certification	CE/ FCC Class A
Power Requirement	
Power Input	DC 9~36V (3-pin terminal block: V+, V-, GND)
Max. Power Consumption	120W
Remote Control	1x3-pin terminal block for remote control and PWR LED output
Power Ignition	IGN +/-
Mechanical	
Construction	Sheet Metal + Aluminum Alloy
Mounting	Wall-mount (standard)
	DIN-rail or VESA mount (optional w/ CTOS bracket)
Weight	3.7kg
Dimensions (W x D x H)	210 x 180 x 70 mm
OS Support	
Windows 10 IoT	
Ubuntu 18.04	

1.3. Inside the Package

Upon opening the package, carefully inspect the contents. If any of the items is missing or appears damaged, contact your local dealer or distributor. The package should contain the following items:



1 x ARES-1980



Terminal blocks:
2 x 10 Pin
2 x 3 Pin
1 x 2 Pin



1 x USB dongle bracket



- User's manual

This page is intentionally left blank.

Chapter 2

Getting Started

2.1. Dimensions

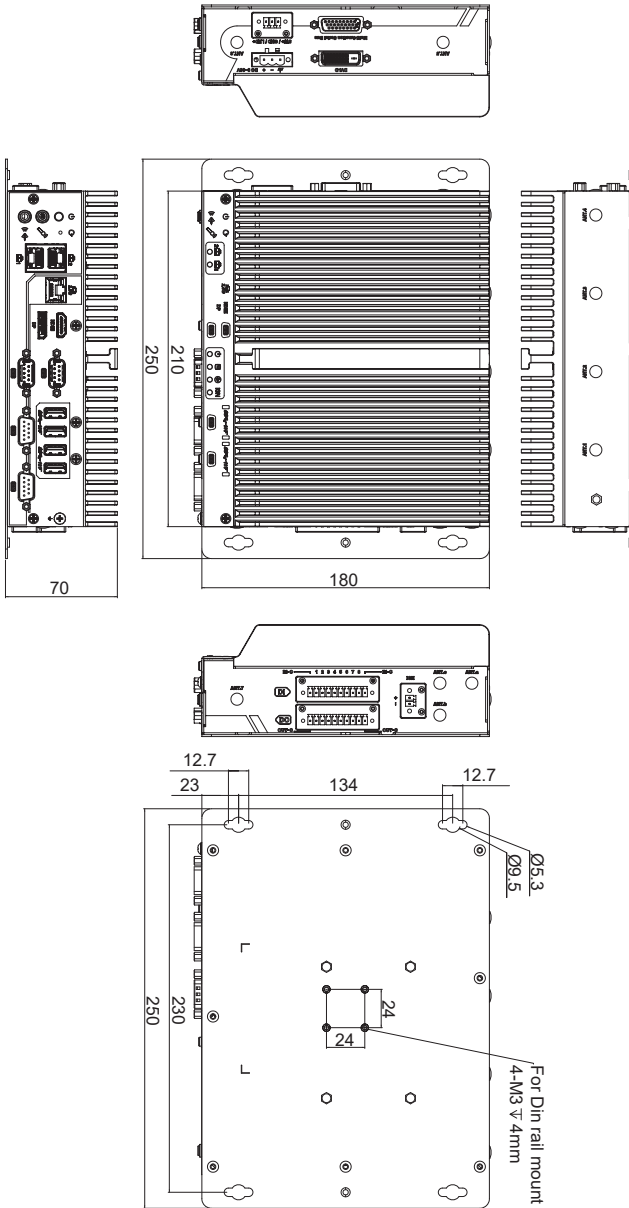

2.2. Overview

2.2.1. Front View

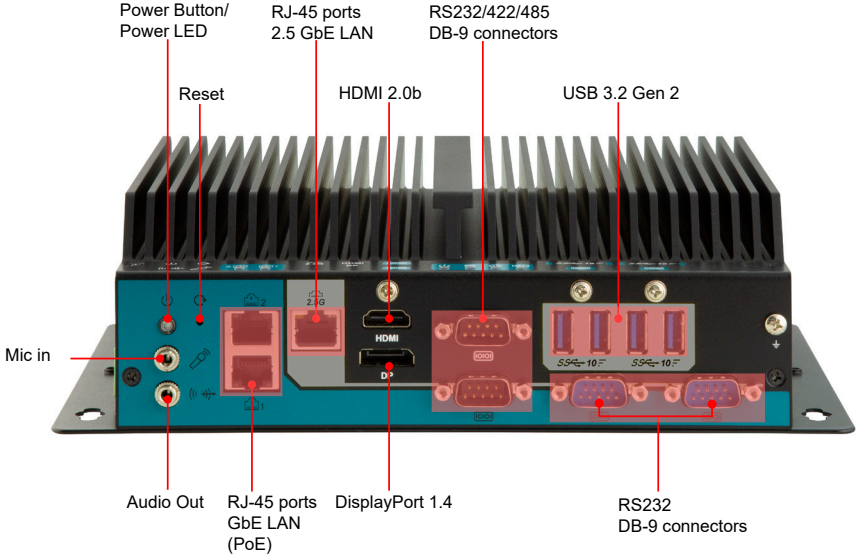

2.2.2. Left Side View

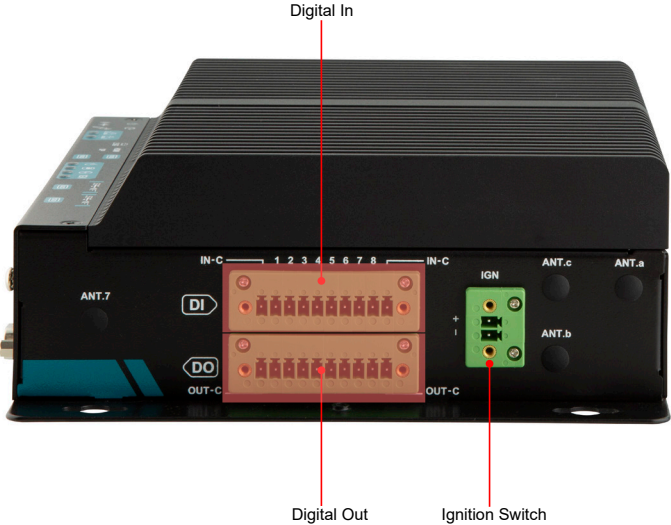



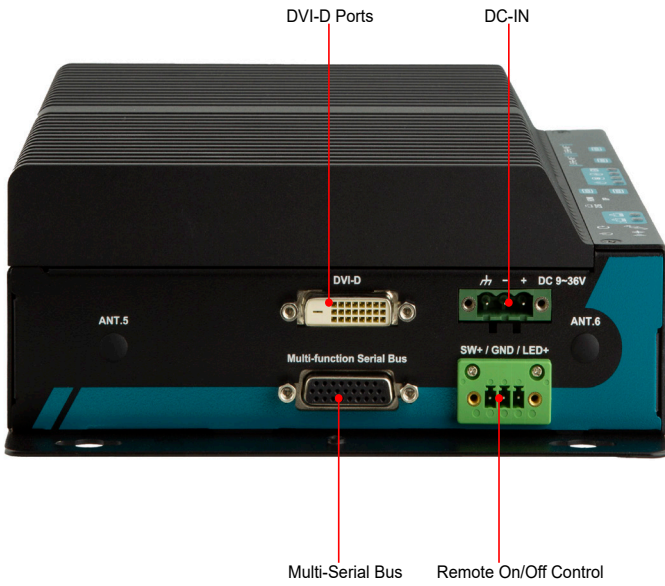

2.2.3. Right Side View

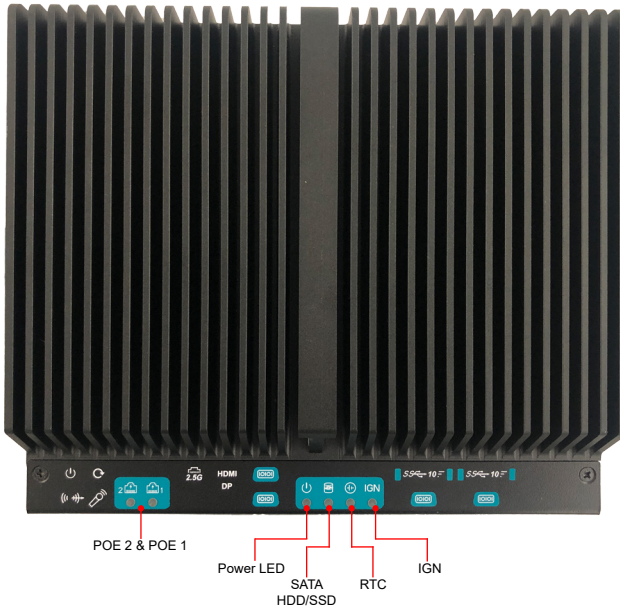

2.2.4. Top Side View



2.2.5. LED Indicator Status

LED Indicator	Icon	Blinking Mode	Status
PWR		Solid Green	System powered on
SATA HDD/SSD		Flashing Red	Data transmitting
RTC		Solid Red	RTC battery is low
IGN	IGN	Flashing Green	IGN settings is detected
		Solid Green	Normal operating
PoE 1		Solid Amber	Active
PoE 2			

2.3. Driver Installation Note

For operating system of Windows 10, please go to our website at **www.arbor-technology.com** and download the driver pack from the product page. Then unzip the downloaded file and follow the sequence below to install the drivers to prevent errors:

Chipset → **Graphic** → **Audio** → **Other drivers**

The driver path is listed as below:

Windows 10

Driver	Path
Chipset	WIN10\Chipset\10.1.1.42\SetupChipset.exe
LAN	WIN10\Ethernet\PROWinx64.exe
VGA	WIN10\Graphics\Setup.exe
Audio	WIN10\AUDIO\0006-64bit_Win7_Win8_Win81_Win10_R279.exe
ME	WIN10\ME_11.6\SetupME.exe

This page is intentionally left blank.

Chapter 3

Engine of the Computer

3.1. Boards Overview

The PCBs of the computer varies according to the models. The following table lists the PCBs of each model:

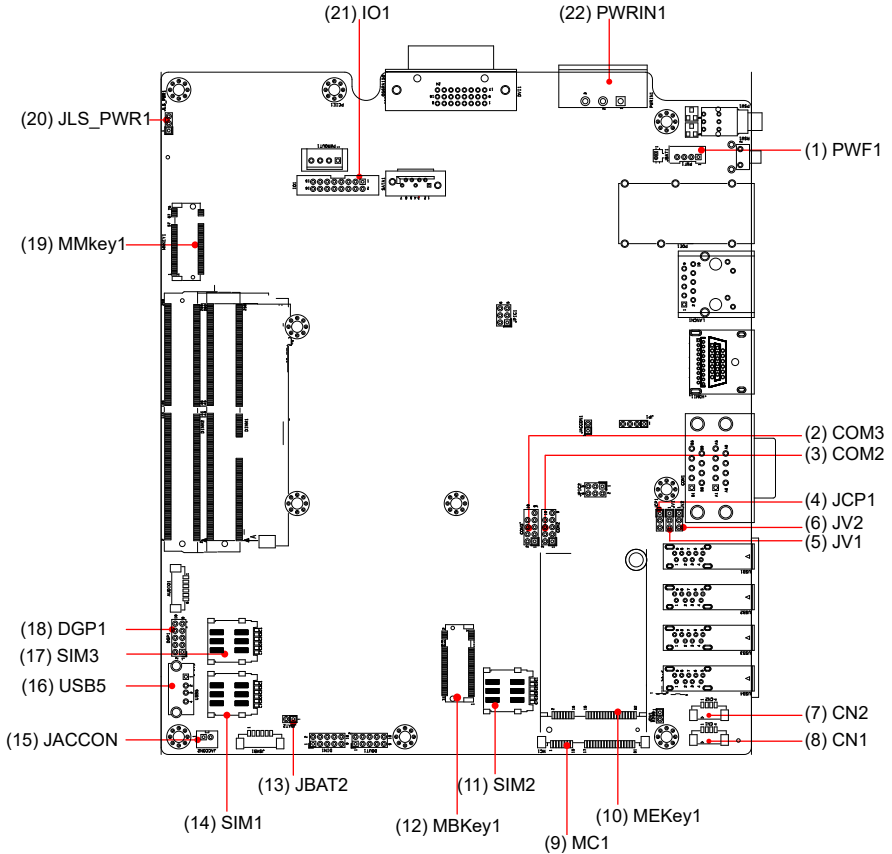

Connectors

Label	Description
(1) PWF1	Power button and Power LED Connector
(2) COM3	COM port for 9pin D-SUB
(3) COM2	COM port for 9pin D-SUB
(4) JCP1	Power selection for COM port
(5) JV1	COM1 function
(6) JV2	COM2 function
(7) CN2	USB2.0 wafer connector
(8) CN1	USB2.0 wafer connector
(9) MC1	PCI Express Mini-card socket
(10) MEKEY1	M.2 E-Key socket
(11) SIM2	Nano SIM card socket
(12) MBKEY1	M.2 B-Key socket
(13) JBAT2	Reset CMOS settings
(14) SIM1	Nano SIM card socket
(15) JACCON2	Acc mode selection for vehicles
(16) USB5	USB connector
(17) SIM3	Nano SIM card socket
(18) DGP1	External debug port
(19) MMKEY	M.2 M-Key socket
(20) JLS_PWR1	Multi Serial Bus power connector
(21) Multi Serial Bus	Multi Serial Bus connector
(22) PWRIN1	Power Input Terminal Block

3.2. Connectors

(1) PWF1

Function: Power button and Power LED Connector
Connector Type: 2.00 mm pitch 1x4-pin one-wall connector
Pin Assignment:

Pin	Desc.
1	PWR_IN_SW#
2	GND
3	LED+
4	NC



(2)(3) COM2/3 (COM3/4 on front panel)

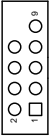

Function: RS232 DB9 connector
Connector Type: 2.00 mm pitch 2x5 pin box header
Pin Assignment:

	Pin	Desc.	Pin	Desc.
	1	DCD	2	RXD
	3	TXD	4	DTR
RS232	5	GND	6	DSR
	7	RTS	8	CTS
	9	RI	10	NC





(4)JCP1

Function: Power selection for COM port
Jumper Type: Onboard 2.00mm-pitch 1x3-pin header
Setting:

Pin	Description	
Short 1-2	COM_5V	
Short 2-3	COM_12V	

(5)(6)JV1/JV2

Function: RI/5V/12V (Pin 9) Selection for COM Port
Jumper Type: Onboard 2.00mm-pitch 1x3-pin header
Setting:

Pin	Description	
Short 1-2	RI (default)	
Short 2-3	5V or 12V (depends on JCP1)	

(7)(8) CN1/CN2

Function: USB2.0 Wafer
Connector Type: onboard Type 4pin wafer
Pin Assignment:

Pin	Desc.
1	VCC5
2	DATA-
3	DATA+
4	GND

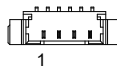

(9) MC2

Function: PCI Express Mini-card Full socketed
Connector Type: Onboard 0.8mm pitch 52-pin edge card connector.
Pin Assignment:

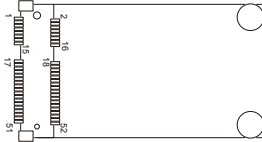

(10) MEKEY1

Function: M.2 E-Key socket (w/ CNVi+USB2.0) for optional Wi-Fi/BT
Connector Type: M.2 E-Key 2230 Socket
Pin Assignment: The pin assignments conform to the industry standard.

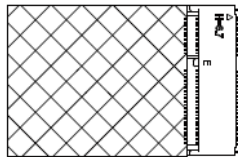

(11) SIM2

Function: SIM Card Socket
Connector Type: 6-pin SIM card socket
Pin Assignment:

Pin	Desc.	Pin	Desc.
C1	VCC	C2	RST
C3	CLK	C5	GND
C6	VPP	C7	I/O

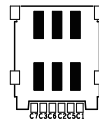



(12) MBKEY1

Function: M.2 B-Key socket (w/ PCIe + USB 3.0 or PCIe x2)(either one)
Connector Type: M.2 B-Key
Pin Assignment: The pin assignments conform to the industry standard.

(13) JBAT2

Function: Clears/keeps CMOS
Jumper Type: 2.00 mm pitch 1x2-pin header
Setting:

Pin	Description
Short Clears CMOS	<div style="text-align: center;"> 1 2  </div>
Open Keeps CMOS (default)	<div style="text-align: center;"> 1 2  </div>

(14) SIM1

Function: SIM Card Socket
Connector Type: 6-pin SIM card socket
Pin Assignment:

Pin	Desc.	Pin	Desc.
C1	VCC	C2	RST
C3	CLK	C5	GND
C6	VPP	C7	I/O

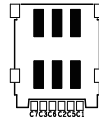

(15) JACCON2

Function Ignition Power Connector
Connector Type: Onboard 2x1-pin box connector
Pin Assignment:

Pin	Description
1	Acc_ON
2	GND

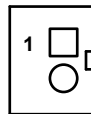

(16) USB5

Function: Internal USB 2.0 connector
Connector Type: USB2.0 Type-A connector
Pin Assignment: The Pin assignment conform to the industry standard.



(17) SIM3

Function: SIM Card Socket
Connector Type: 6-pin SIM card socket
Pin Assignment:

Pin	Desc.	Pin	Desc.
C1	VCC	C2	RST
C3	CLK	C5	GND
C6	VPP	C7	I/O

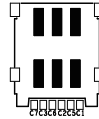

(18) DGP1

Function: Debug port
Connector Type: 2.00mm-pitch 2x5-pin header
Pin Assignment:

Pin	Description	Pin	Description
1	24MHz Clock	2	GND
3	LPC_FRAME#	4	LPC_LAD0
5	PLTRST#	6	N.C
7	LPC_LAD3	8	LPC_LAD2
9	VCC3	10	LPC_LAD1



(19) MMKEY1

Function: M.2 M-Key Connector
Connector Type: M.2 75-pin M-Key connector for PCIe x4/SATA-III SSD storage, supporting 22x42 / 22x80 modules
Pin Assignment: The pin assignments conform to the industry standard.



(20) JLS_PWR1

Function: Multi Serial Bus power connector
Jumper Type: Onboard 2.00mm-pitch 1x3-pin header
Setting:

Pin	Description
Short 1-2	5V(default)
Short 2-3	3.3V



(21) IO1

Function: Multi Serial Bus connector
Connector Type: 2.00mm-pitch 2x8-pin header
Pin Assignment:

Pin	Description	Pin	Description
1	I2C0_SCL	2	I2C0_SDA
3	SPI_MISO	4	SPI_MOSI
5	SPI_CLK	6	SPI_CS#
7	LS_PWR 5V(default)/3.3V	8	GND
9	I2C1_SCL	10	I2C1_SDA
11	UART_TXD	12	UART_RXD
13	UART_RTS#	14	UART_CTS#
15	NC	16	GND



(22) PWRIN1

Function: Power input terminal block
Connector Type: 1x3-pin Terminal block
Pin Assignment:

Pin	Desc.
1	VCC
2	GND
3	D_GND

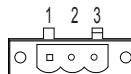

This page is intentionally left blank.

Chapter 4

Installation & Maintenance

4.1. Disassembling and Assembling the Computer

4.1.1. Disassembling the Computer

To use onboard jumpers/connectors or to install/remove internal components, you will need to open the computer to access the inside of the computer. Follow through the guide below to disassembly the computer.

1. Position the computer with the bottom side facing up and remove 8 screws securing the chassis as shown below .



2. Then lift the bottom chassis away from the from the assembly.
3. You are ready to access the components on the main board and make required configurations and connections.

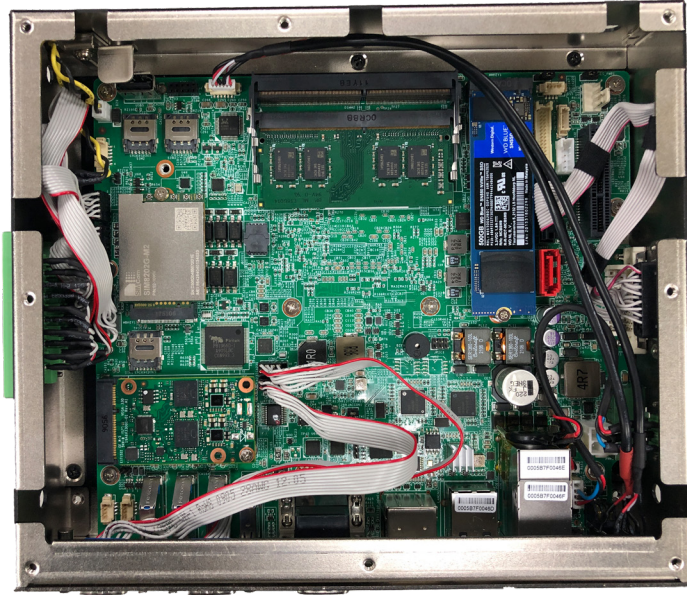

4.1.2. Assembling the Computer

After completing the required hardware installation and jumpers settings, assemble the computer by performing the proceeding steps in reverse order.

4.2. Installing Hardware

4.2.1. Installing Memory Module

The computer has two 260-pin DDR4 SO-DIMM sockets that each socket support up to 32 GB maximum system memory. To install a memory module:

1. Open the ARES-1980's case and locate memory module sockets.

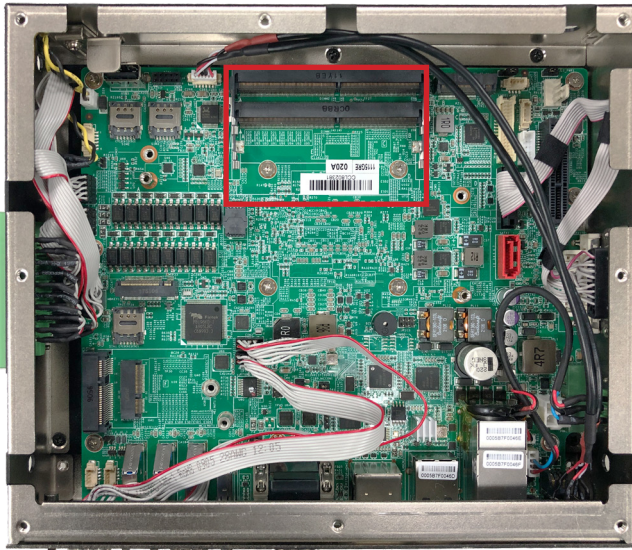

2. Align the notch on the memory module with the key in the module socket.

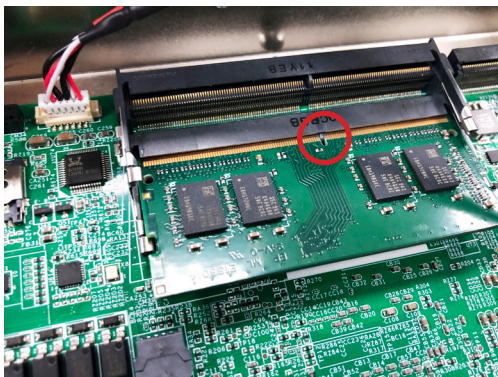

- Slide the module into place. Once the memory module is fully inserted into the socket, press down on the top edge of the device to latch it into place.

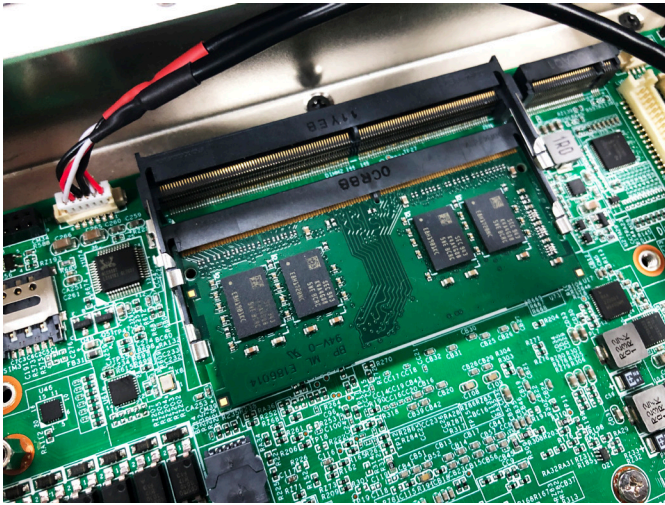

- This way it's flat to the laptop's bottom. The carrier should snap into place with latches.

4.2.2. Installing/Replacing a SSD or HDD

1. Remove the hard drive bay from the bottom side chassis by loosening the 4 screws.

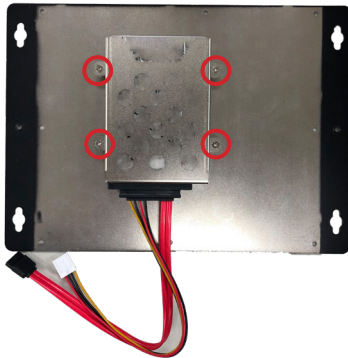

2. Slide the 2.5" HDD or SSD storage device into the drive bay and ensure it connects to the SATA connector.

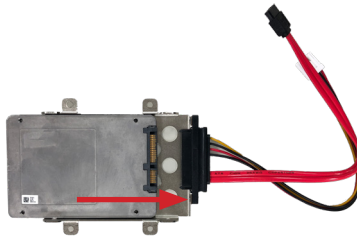

3. Using 4 screws coming with the storage device kit, fix the storage device in place.

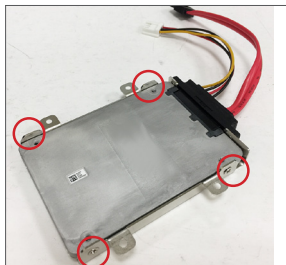

4. Connect the SATA interface and power cables to the SATA & power connectors on the main board.

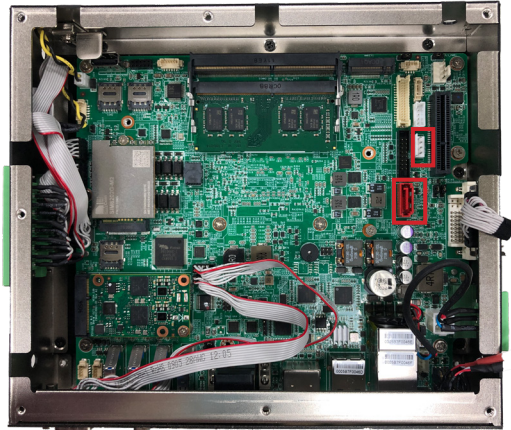

5. Secure the drive bay back to the bottom side chassis by fastening the 4 screws you removed in Step 1.

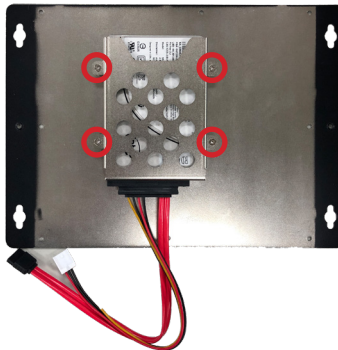

4.2.3. Installing M.2 Module

The computer has a M.2 M-Key socket for NVMe SSD storage. This section will use a 22 x 80 form factor as the installation example.

1. Remove the bottom cover from the computer as described in [4.1.1. Disassembling the Computer](#) on page [24](#). Locate the M.2 on-board connector.

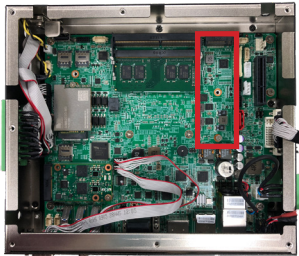

2. Insert the M.2 module into the socket by aligning the notch on the module with the small slot on the M.2 socket.



3. Insert and fasten the screw into the standoff.

4.2.4. Installing Encryption Dongle

The computer has a USB 2.0 connector on the main board for the users who need additional secured encryption key installed. If an encryption dongle requirement was needed, user can use this USB connector inside the computer.

Note: The USB dimension need to be 19mm to 30mm.

1. Locate the USB connector on the main board.

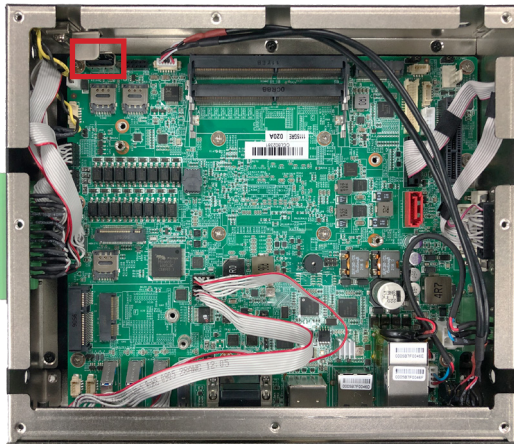

2. Insert the encryption dongle and secure the rack for vibration proof.

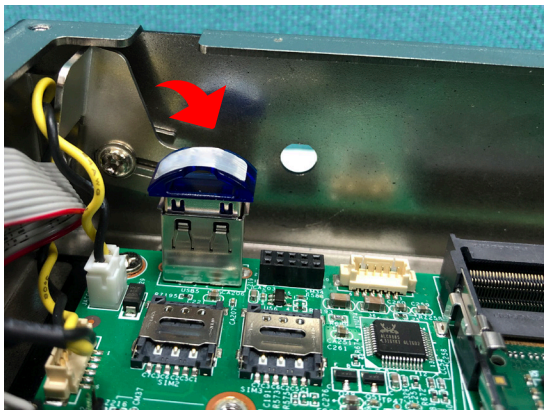

4.2.5. Install/uninstall SIM Card and relative connection module

This section will guide you how to install SIM card and relative connection module.

1. Remove the bottom cover from the computer as described in [4.1.1. Disassembling the Computer](#) on page [24](#).
2. Locate the SIM card slot on the main board.

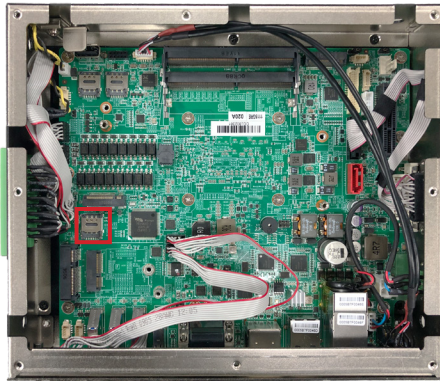

3. Slide the SIM card holder cover towards the OPEN edge and then lift the cover to open it.

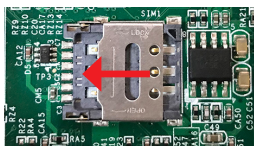

4. Insert the SIM card into the card holder as shown below.



5. Close the SIM card holder door and slide the door to the LOCK edge to lock into place.

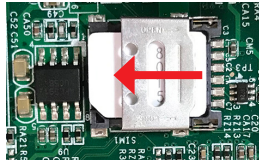

6. Locate the MC1 slot and insert the relative communication module then fasten the screw.

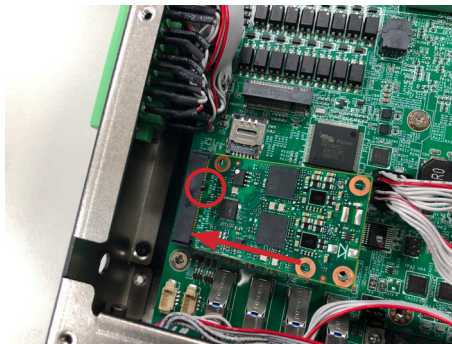
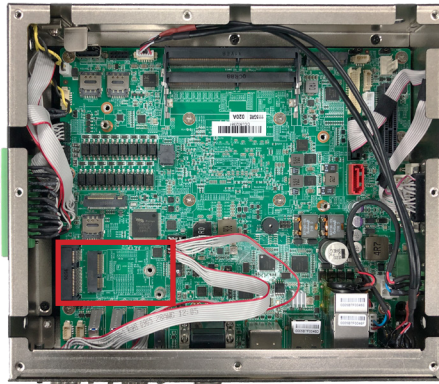

7. If the other SIM card is needed, please follow the steps above and install the SIM card in the second or third position as the picture.

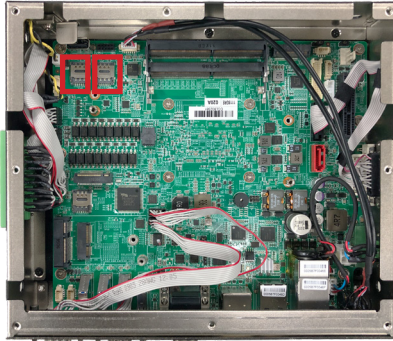

8. Locate the MBKEY slot and insert the relative communication module then fasten the screw.

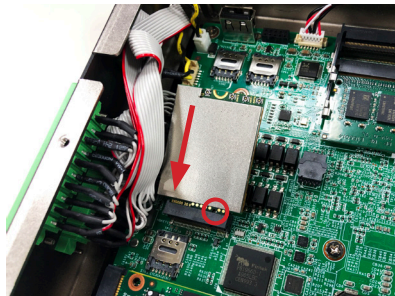
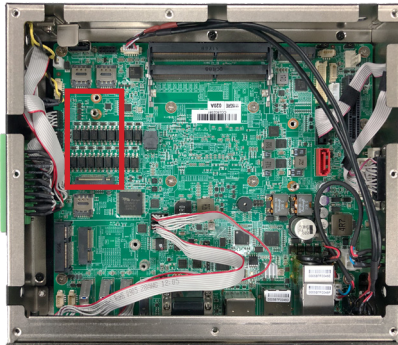

4.2.6. Install/uninstall WI-FI connection module

1. Remove the bottom cover from the computer as described in [4.1.1. Disassembling the Computer](#) on page [24](#).
2. Locate the **M.2 E-Key** socket for wireless module.

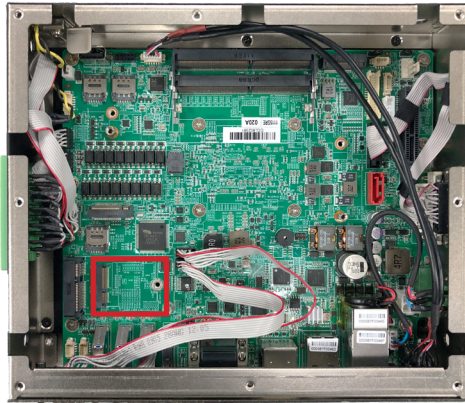

3. Prepare the Wi-Fi module kit. The module is a **M.2 E-Key** socket form factor, with two MHF connectors, one is “MAIN”, and the other is “AUX”.

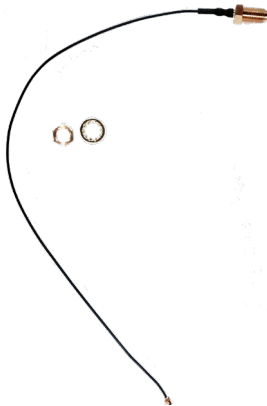

Two MHF connectors, one is “MAIN” (marked 2), the other is “AUX” (marked 1).



4. Have the RF antenna. The antenna has an SMA connector on one end and an MHF connector on the other.

5. Connect the RF antenna's MHF connector to the Wi-Fi module's main connector marked 0. If you are going to connect a secondary antenna, connect it to the connector marked 2

Connect the RF antenna's MHF connector to the Wi-Fi module's main connector (marked 2)

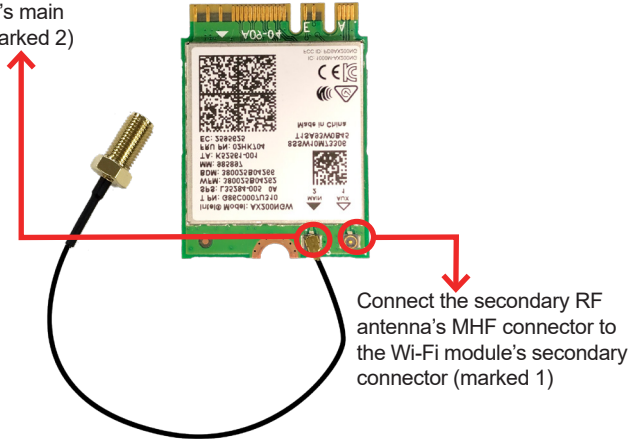

6. Plug the Wi-Fi module to the socket's connector by a slanted angle. Fully plug the module, and note that the notch on the wireless module should meet the break of the connector, then fasten the screw.



7. Locate the SMA antenna holes and. Remove the plastic plug(s) from the computer's top panel side to make antenna hole(s). Keep the plastic plug for any possible restoration in the future.



- From the other end of the RF antenna, which is an SMA connector, remove the washer and the nut. Note the SMA connector has the form of a threaded bolt, with one flat side.

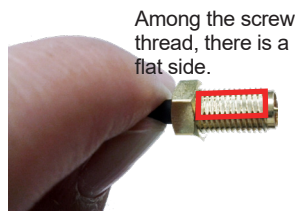
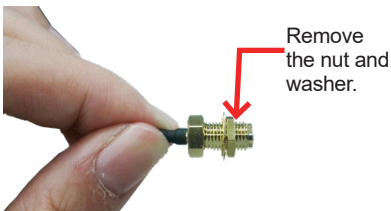

- Pull the SMA connector through the above mentioned antenna hole. Note to meet the aforesaid flattened side with the antenna hole's flat side.

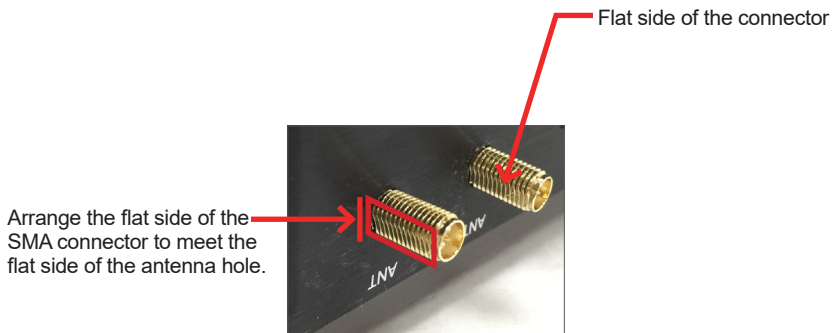

10. Mount the washer first and then the nut to the SMA connector. Make sure the nut is tightened.

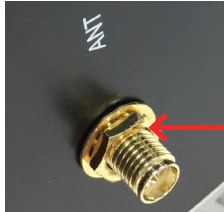

Mount the washer and the nut to the SMA connector. Tighten the nut.

11. After completing the required hardware installation, assemble the computer by performing the proceeding steps in reverse order.

Chapter 5

BIOS

BIOS

The BIOS Setup utility is featured by American Megatrends Inc to configure the system settings stored in the system's BIOS ROM. The BIOS is activated once the computer powers on. When the computer is off, the battery on the main board supplies power to BIOS RAM.

To enter the BIOS Setup utility, keep hitting the "Delete" key upon powering on the computer.

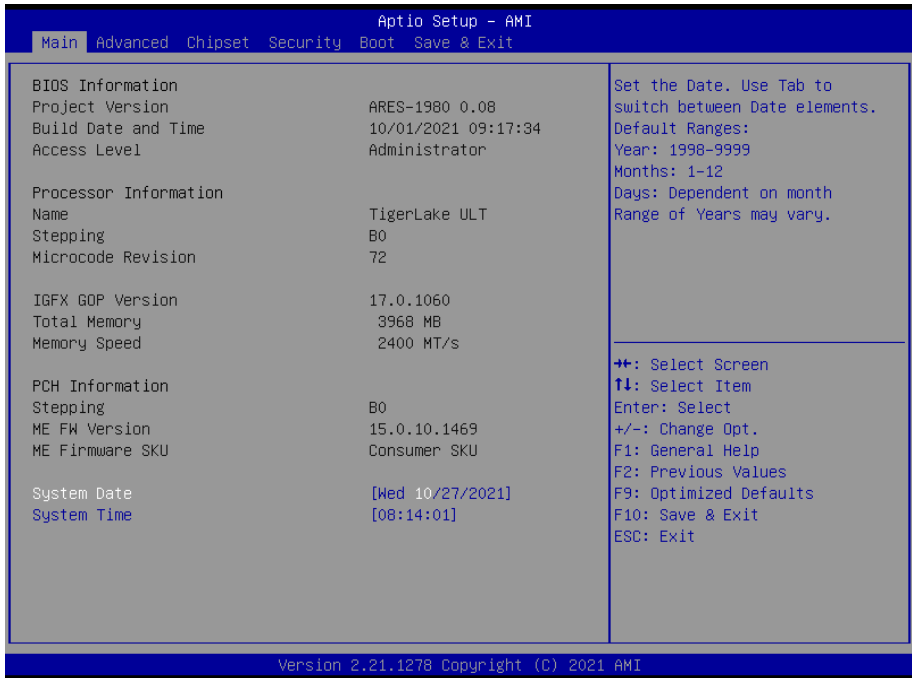

Note: Actual model name and board information varies according to your model.

Menu	Description
Main	See 5.1. Main on page 42
Advanced	See 5.2. Advanced on page 43
Chipset	See 5.3. Chipset on page 59
Security	See 5.4 Security on page 66
Boot	See 5.5. Boot on page 68
Save & Exit	See 5.6. Save & Exit on page 69

Key Commands

The BIOS Setup utility relies on a keyboard to receive user's instructions. Hit the following keys to navigate within the utility and use the utility.

Keystroke	Function
← →	Moves left/right between the top menus.
↓ ↑	Moves up/down between highlight items.
Enter	Selects an highlighted item/field.
Esc	<ul style="list-style-type: none"> ▶ On the top menus: Use Esc to quit the utility without saving changes to CMOS. (The screen will prompt a message asking you to select OK or Cancel to exit discarding changes. ▶ On the submenus: Use Esc to quit current screen and return to the top menu.
Page Up / +	Increases current value to the next higher value or switches between available options.
Page Down / -	Decreases current value to the next lower value or switches between available options.
F1	Opens the Help of the BIOS Setup utility.
F10	Exits the utility saving the changes that have been made. (The screen then prompts a message asking you to select OK or Cancel to exit saving changes.)

Note: Pay attention to the "WARNING" that shows at the left pane onscreen when making any change to the BIOS settings.

This BIOS Setup utility is updated from time to time to improve system performance and hence the screenshots hereinafter may not fully comply with what you actually have onscreen.

5.1. Main

The **Main** menu features the settings of **System Date** and **System Time** and displays some BIOS info.

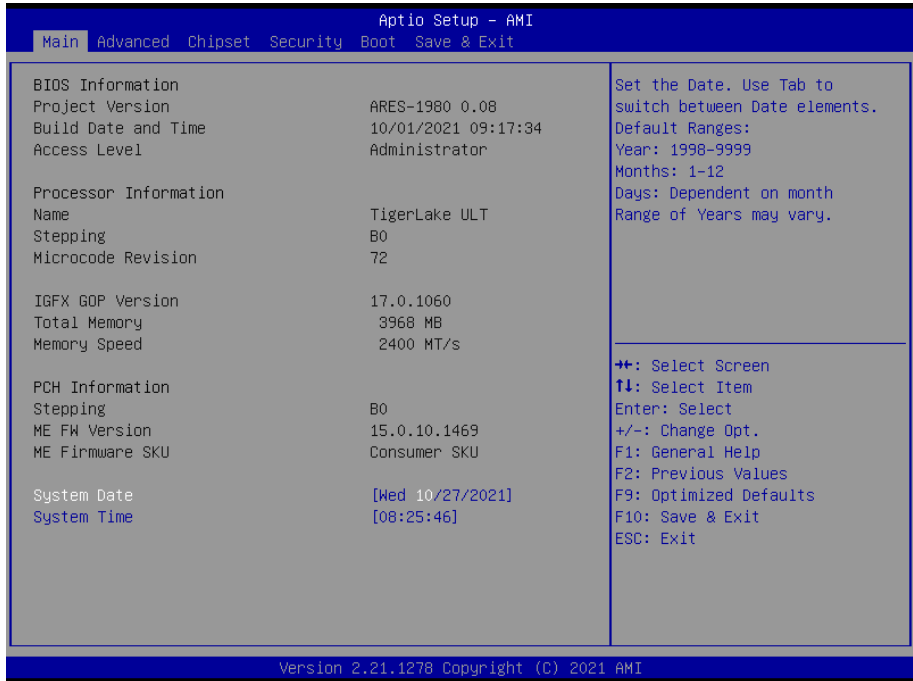

Note: Actual model name and board information varies according to your model.

Setting	Description
Project Version	Delivers the model name of the computer and BIOS version.
Build Date and Time	Delivers the date and time when the BIOS Setup utility was made/ updated.
Access Level	Delivers the level that the BIOS is being accessed at the moment.
System Date	Sets system date.
System Time	Sets system time.

5.2. Advanced



Setting	Description
CPU Configuration	See 5.2.1. CPU Configuration on page 44
Power & Performance	See 5.2.2. Power & Performance on page 45
Trusted Computing	See 5.2.3. Trusted Computing on page 48
ACPI Settings	See 5.2.4. ACPI Settings on page 50
F81966 Super IO Configuration	See 5.2.5. F81966 Super IO Configuration on page 51
Hardware Monitor	See 5.2.6. Hardware Monitor on page 52
S5 RTC Wake Settings	See 5.2.7. S5 RTC Wake Settings on page 53
Serial Port Console Redirection	See 5.2.8. Serial Port Console Redirection on page 54
USB Configuration	See 5.2.9. USB Configuration on page 55
Network Stack Configuration	See 5.2.10. Network Stack Configuration on page 57
NVMe Configuration	See 5.2.11. NVMe Configuration on page 58 .

5.2.1. CPU Configuration



Setting	Description
Intel (VMX) Virtualization Technology	When enabled, a VMM can utilize the additional hardware capabilities provided by Vanderpool Technology ► Options: Enabled (default) or Disabled
Active Processor Cores	Number of cores to enable in each processor package. ► Options: All (default), 1 , 2 and 3 .
Hyper-Threading	This item is used to enable or disable the processor's Hyper-threading feature. Enabled for Windows XP and Linux (OS optimized for Hyper-threading Technology) and disabled for other OS (OS not optimized for Hyper-threading Technology). When disabled, only one thread per enabled core is enabled. ► Options: Enabled (default) or Disabled * This setting may not be available depending on the CPU.

5.2.2. Power & Performance

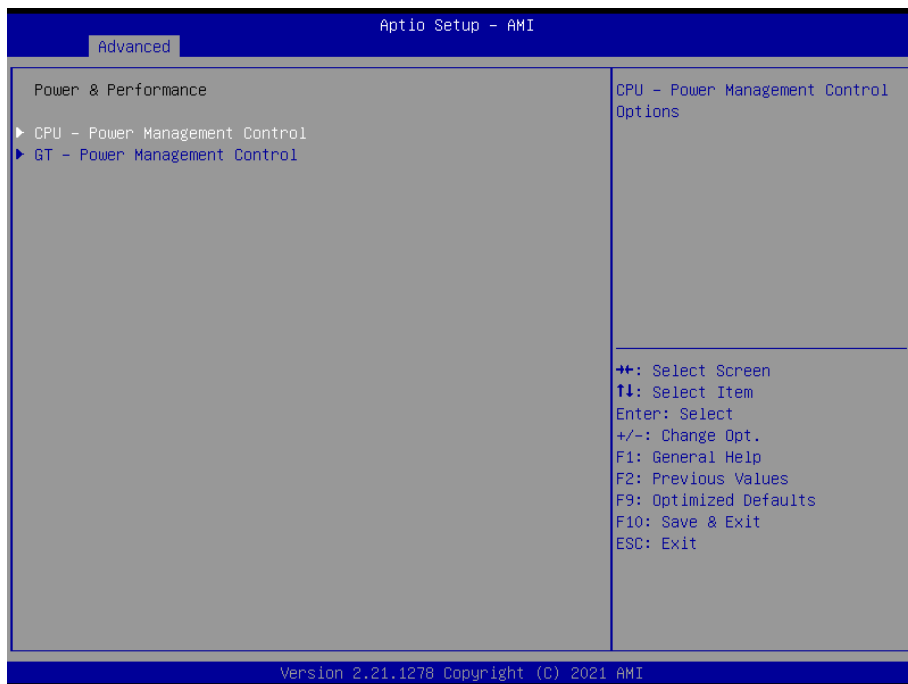

Setting	Description
CPU - Power Management Control	Configure CPU Power Management See 5.2.2.1 CPU Power & Performance on page 46
GT - Power Management Control	Configure graphics processors Power Management See 5.2.2.2 GT Power & Performance on page 47

5.2.2.1 CPU Power & Performance

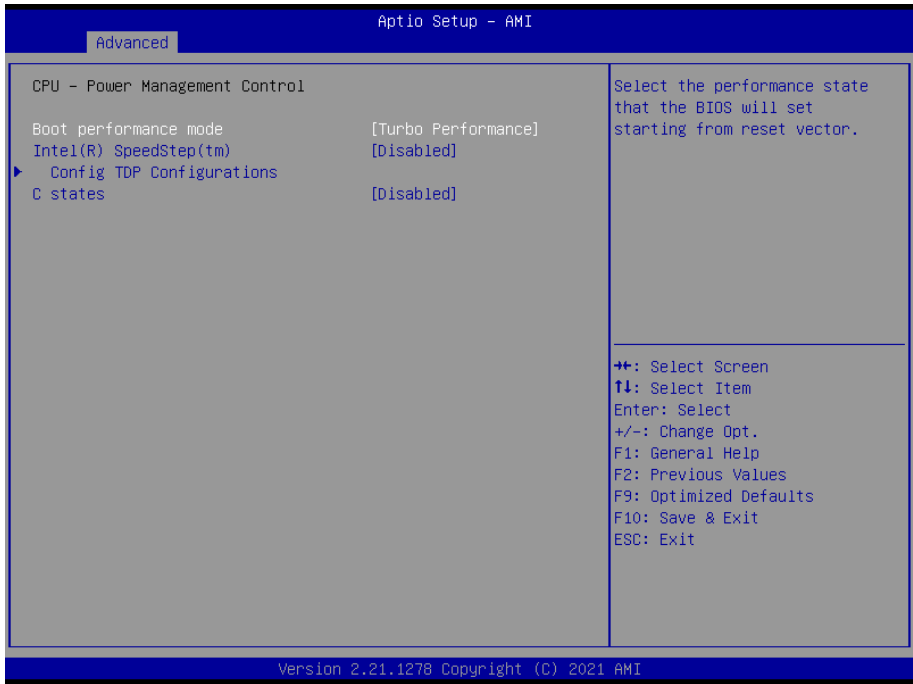

Setting	Description
Boot performance Mode	Set the performance state that the BIOS will set before the OS handoff. ► Options: Max Non-Turbo Performance (default), Max Battery and Turbo Performance
Intel (R) Speed Step (tm)	Enable (default) / Disable Intel SpeedStep
Config TDP Configurations	Configurable TDP Mode
C States	Enable / Disable (default) CPU C States

5.2.2.2 GT Power & Performance

Aptio Setup - AMI

Advanced

GT - Power Management Control RC6(Render Standby) [Enabled] Maximum GT frequency [Default Max Frequency] Disable Turbo GT frequency [Disabled]	Check to enable render standby support. ⇧⇩: Select Screen ↑↓: Select Item Enter: Select +/-: Change Opt. F1: General Help F2: Previous Values F9: Optimized Defaults F10: Save & Exit ESC: Exit
---	--

Version 2.21.1278 Copyright (C) 2021 AMI

Setting	Description
RC6 (Render Standby)	Function of activation and deactivation the energy-saving mechanism integrated into the Intel graphics core processors when the computer enters sleep mode. Enable (default) / Disable
Maximum GT frequency	This item maximum GT frequency limited by te user. Value beyond the range will be clipped to min/max supported by SKU. Default Max Frequency (default)
Disable Turbo GT frequency	This item Disable Turbo GT frequency. Enabled : Disables Turbo GT frequency. Disabled : GT frequency is no limited. Disabled (Default) / Enabled

5.2.3. Trusted Computing

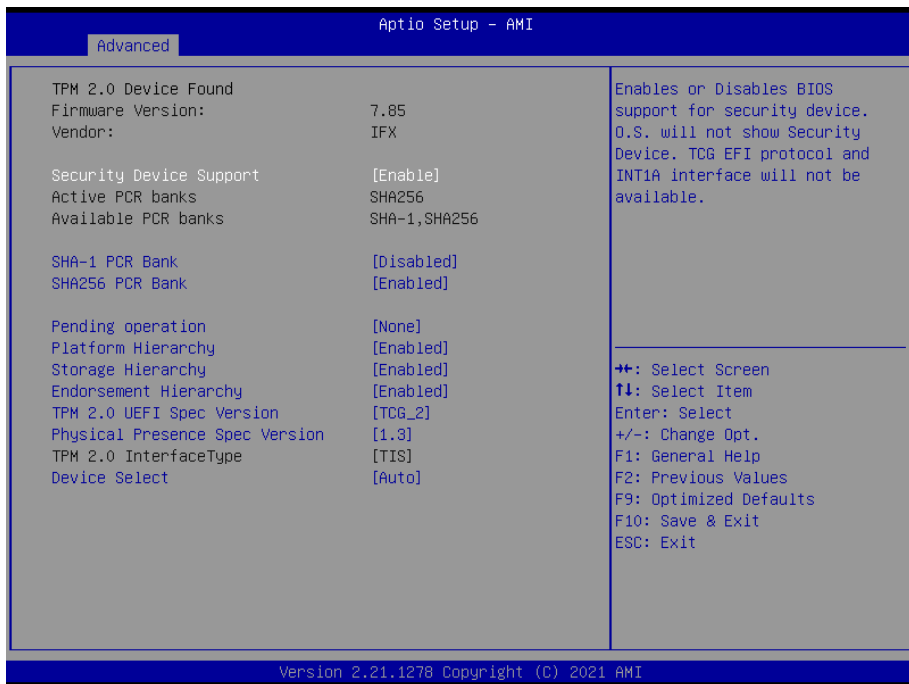

Setting	Description
Security Device Support	This item enables or disables BIOS support for security device. O.S will not show Security Device. Enabled (Default) / Disabled
SHA-1 PCR Bank	This item enables or disables SHA-1 PCR Bank. Enabled/Disabled(Default)
SHA256 PCR Bank	Enables or disables SHA-1 PCR Bank. Enabled (Default) / Disabled
Pending operation	This item schedule an operation for the security device. None (Default) / TPM Clear
Platform Hierarchy	Enables or disables Platform Hierarchy Enabled (Default) / Disabled
Storage Hierarchy	Enables or disables Storage Hierarchy Enabled (Default) / Disabled

Endorsement Hierarchy	Enables or disables Endorsement Hierarchy. Enabled (Default) / Disabled
TPM2.0 UEFI Spec Version	Allows user to select the TCG2 Spec Version Support. TCG_1_2: Compatible mode for Win8/ Win10 TCG_2: Support new TCG2 protocol and event for Win10 or later. TCG_1_2/TCG_2 (Default)
Physical Presence Spec Version	This item select to tell O.S. to support PPI Spec Version 1.2 or 1.3. 1.3 (Default) / 1.2
Device Select	TPM 1.2 will restrict support to TPM 1.2 devices, TPM 2.0 will restrict support to TPM 2.0 devices, Auto will support both TPM 2.0 devices and TPM 1.2 devices. Auto(Default)/TPM 1.2/TPM 2.0

5.2.4. ACPI Settings

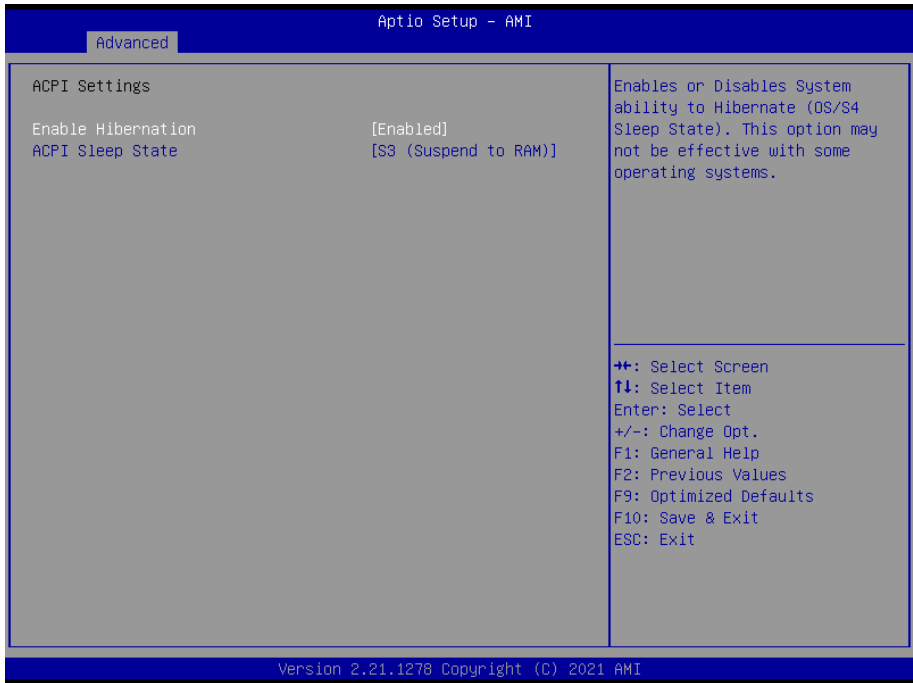

Setting	Description
Enable ACPI Auto Configuration	Enable (default) or Disable BIOS ACPI Auto Configuration
ACPI Sleep State	Only available when BIOS ACPI Auto Configuration is enabled. Select ACPI sleep state the system will enter when the SUSPEND button is pressed. ► Options: Suspend Disabled and S3 (Suspend to RAM) (default)

5.2.5. F81966 Super IO Configuration

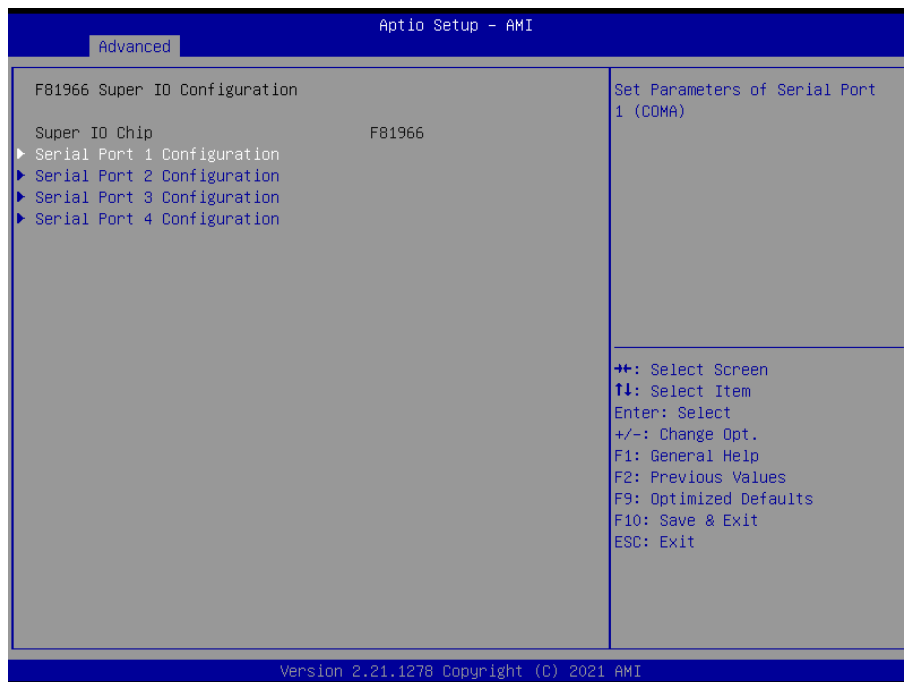

Note: The quantity of serial ports varies according to your model.

Setting	Description
Serial Port 1/2/3/4 Configuration	To configure each COM port settings. Note: The quantity of serial ports varies according to your model.
Serial Port	Enable (default) or Disable the Serial Port (COM).
COM1/2 Mode Select	For Serial Port 1/2: Select RS-232 (default), RS-422 , RS-485 or RS-485 with termination resistor .

5.2.6. Hardware Monitor

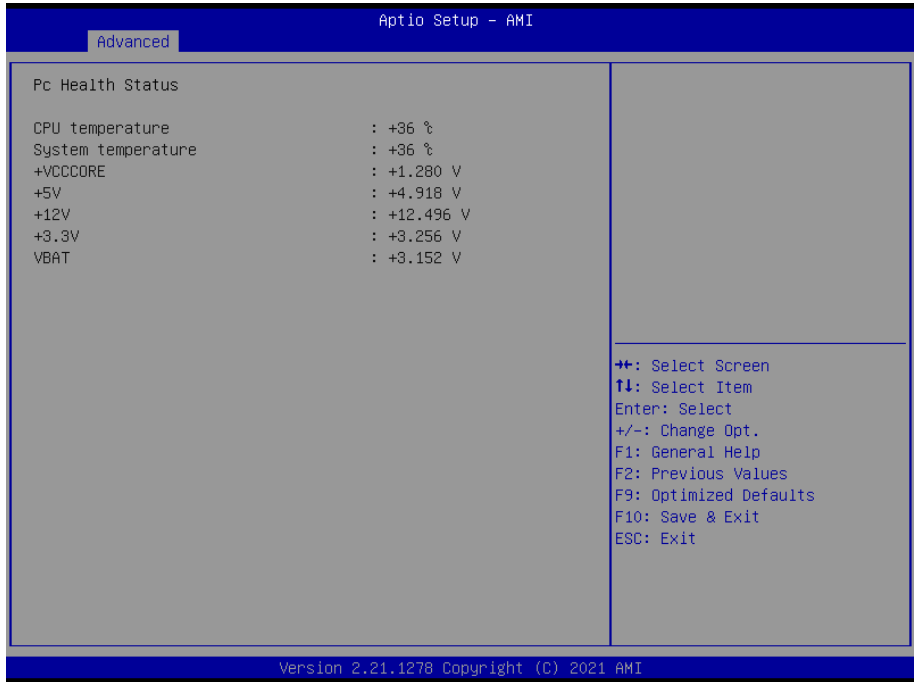

Access this submenu to monitor the hardware status.

5.2.7. S5 RTC Wake Settings



Setting	Description
Wake System from S5	<p>Enable or Disable (default) system wake on alarm event.</p> <p>► Options available are:</p> <p>Disabled (default):</p> <p>Fixed Time: System will wake on the hr::min::sec specified.</p> <p>DynamicTime: If selected, you need to set Wake up minute increase from 1 - 5. System will wake on the current time + increase minute(s).</p>

5.2.8. Serial Port Console Redirection

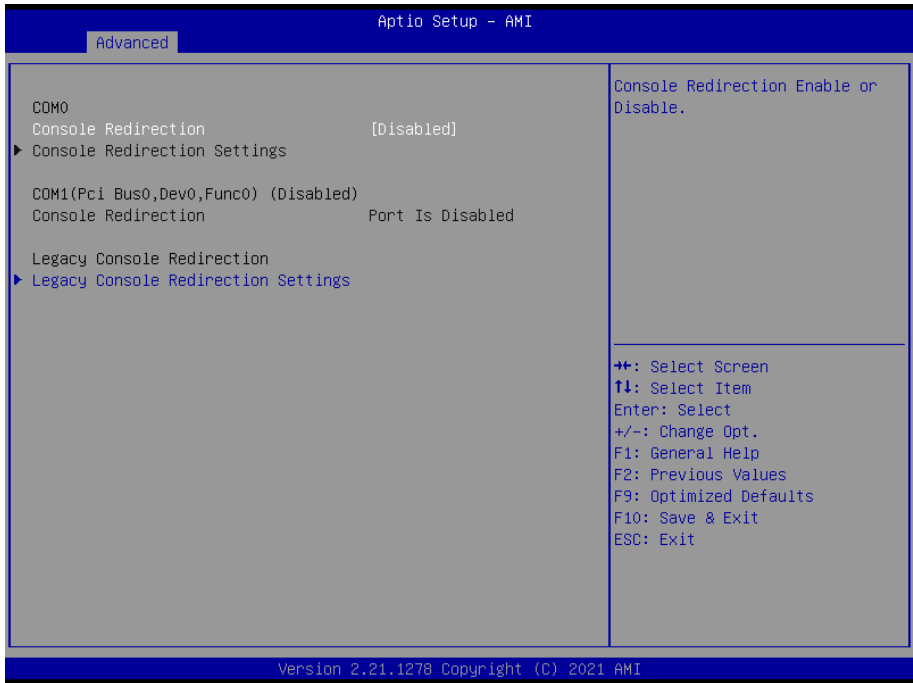

Setting	Description
Serial Port Console Redirection	Allow you to enable or disable the console redirection feature. Enabled / Disabled (Default)
Legacy Console Redirection Settings	Allow you to select a COM part to display redirection of Legacy OS and Legacy OPRom Messages.

5.2.9. USB Configuration

Aptio Setup - AMI

Advanced

<p>USB Configuration</p> <p>USB Module Version 26</p> <p>USB Controllers: 2 XHCIs</p> <p>USB Devices: 1 Drive, 1 Keyboard, 1 Mouse, 2 Hubs</p> <p>Legacy USB Support [Enabled]</p> <p>XHCI Hand-off [Enabled]</p> <p>USB Mass Storage Driver Support [Enabled]</p> <p>USB hardware delays and time-outs:</p> <p> USB transfer time-out [20 sec]</p> <p> Device reset time-out [20 sec]</p> <p> Device power-up delay [Auto]</p> <p>Mass Storage Devices:</p> <p> KingstonDataTraveler 3.0PMAP [Auto]</p>	<p>Enables Legacy USB support. AUTO option disables legacy support if no USB devices are connected. DISABLE option will keep USB devices available only for EFI applications.</p> <hr/> <p> ++: Select Screen ↑↓: Select Item Enter: Select +/-: Change Opt. F1: General Help F2: Previous Values F9: Optimized Defaults F10: Save & Exit ESC: Exit </p>
--	--

Version 2.21.1278 Copyright (C) 2021 AMI

Setting	Description
Legacy USB Support	<p>Enables/disables legacy USB support.</p> <ul style="list-style-type: none"> ▶ Options available are Enabled (default), Disabled and Auto. ▶ Select Auto to disable legacy support if no USB device are connected. ▶ Select Disabled to keep USB devices available only for EFI applications.
XHCI Hand-off	<p>This is a workaround for Oses without XHCI hand-off support. The XHCI ownership change should be claimed by XHCI driver.</p> <ul style="list-style-type: none"> ▶ The optional settings are: Enabled (default) / Disabled.
USB Mass Storage Driver Support	<p>Enables/disables USB Mass Storage Driver Support.</p> <ul style="list-style-type: none"> ▶ The optional settings are: Enabled (default) / Disabled.
USB hardware delay and time-out	

<p>USB transfer time-out</p>	<p>Use this item to set the time-out value for control, bulk, and interrupt transfers.</p> <p>► Options: 1 sec, 5 sec, 10 sec, 20 sec (default)</p>
<p>Device reset time-out</p>	<p>Use this item to set USB mass storage device start unit command time-out.</p> <p>► Options available are: 10 sec, 20 sec (default), 30 sec, 40 sec</p>
<p>Device power-up delay</p>	<p>Use this item to set maximum time the device will take before it properly reports itself to the host controller. 'Auto' uses default value: for a root port it is 100 ms, for a hub port the delay is taken from hub descriptor.</p> <p>► Options available are:</p> <p>Auto: Default</p> <p>Manual: Select Manual you can set value for the following sub-item: 'Device Power-up delay in seconds', the delay range in from 1 to 40 seconds, in one second increments.</p>

5.2.10. Network Stack Configuration



Setting	Description
Network Stack	Enable or Disable (default) UEFI network stack.

5.2.11. NVME Configuration

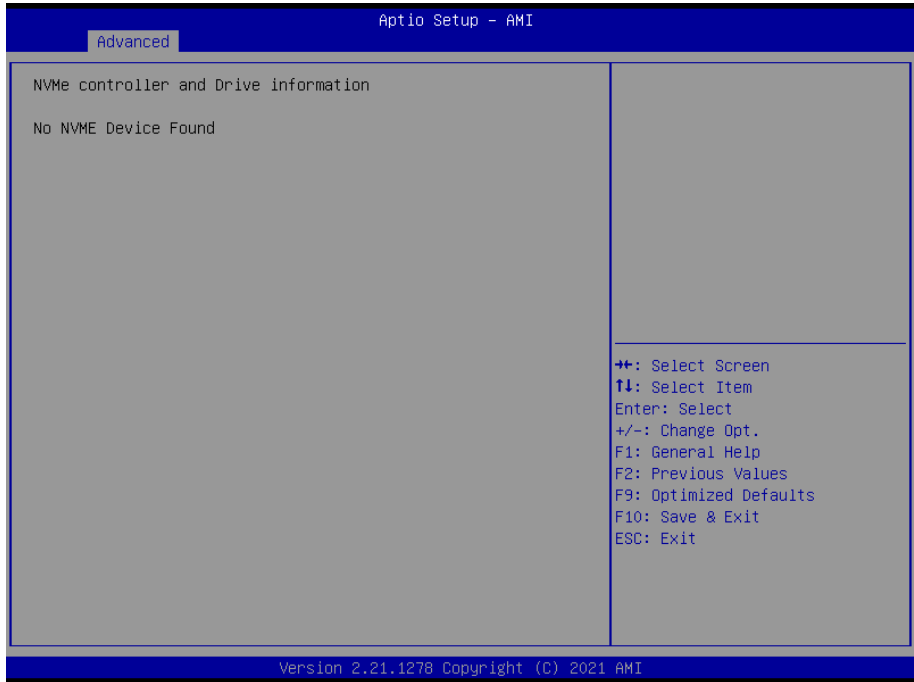

Access this submenu to view the NVMe controller and driver information.

5.3. Chipset



Submenu	Description
System Agent (SA) Configuration	See 5.3.1. System Agent (SA) Configuration on page 60
PCH-IO Configuration	See 5.3.2. PCH-IO Configuration on page 63

5.3.1. System Agent (SA) Configuration

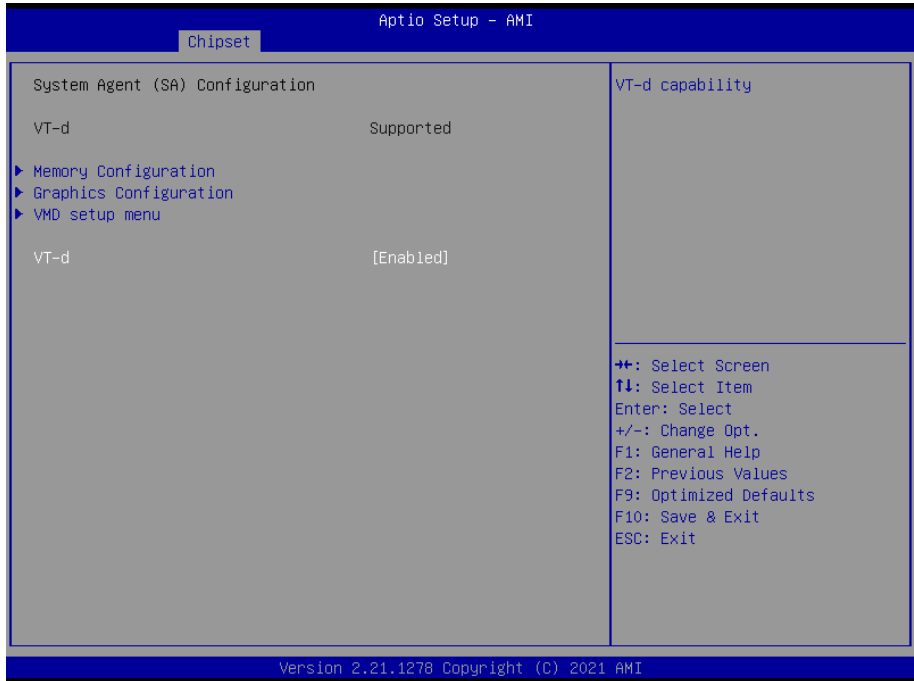

Submenu	Description
System Agent (SA) Configuration	
Memory Configuration	See 5.3.1.1. Memory Configuration on page 61
Graphics Configuration	See 5.3.1.2. Graphics Configuration on page 62
VT-d	Enable (default) or Disable VT-d function

5.3.1.1. Memory Configuration

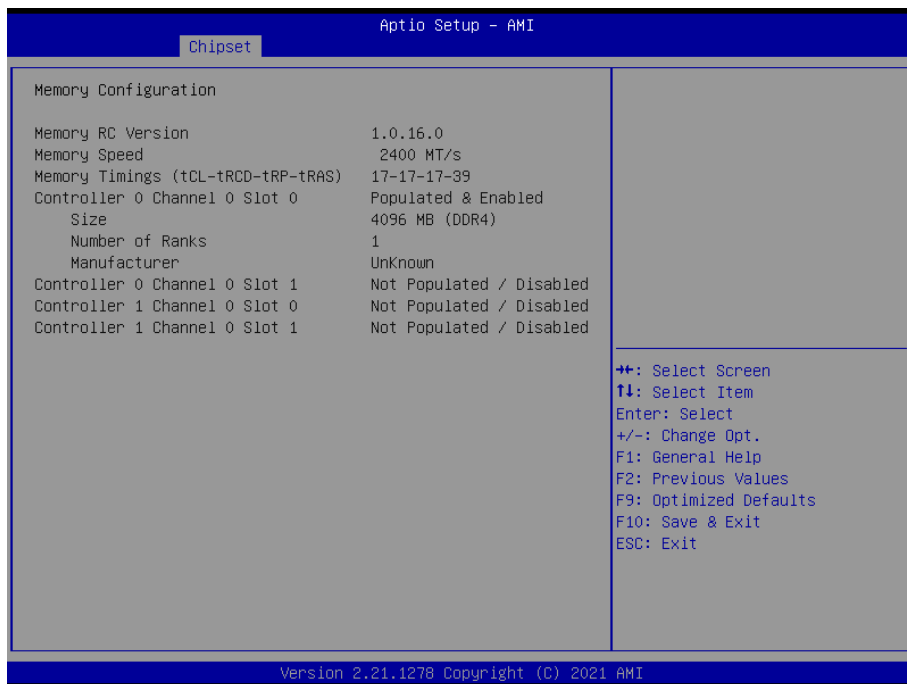

Access this submenu to view the memory configuration.

5.3.1.2. Graphics Configuration

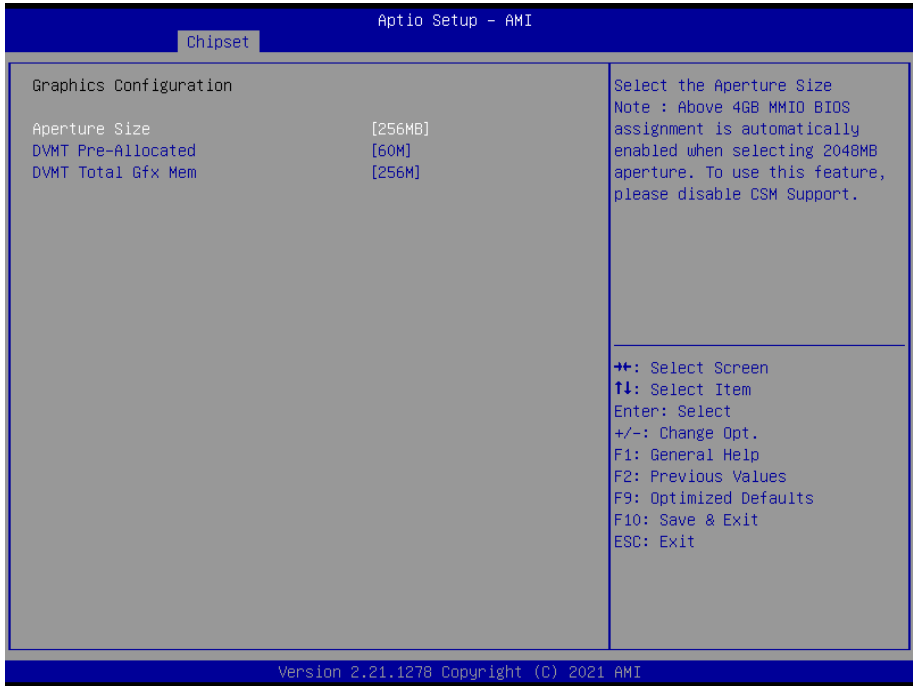

Note: This page varies according to your model.

Setting	Description
Aperture Size	Select the Aperture Size ▶ Options: 128MB , 256MB (default), 512MB and 1024MB .
DVMT Pre-Allocated	Select the DVMT 5.0 Pre-allocated (Fixed) Graphic Memory size used by the Internal Graphic Device. ▶ 60M is the default.
DVMT Total Gfx Mem	Select the DVMT 5.0 Total Graphic Memory size used by the Internal Graphic Device. ▶ Options: 128MB , 256MB (default) and Max .

5.3.2. PCH-IO Configuration

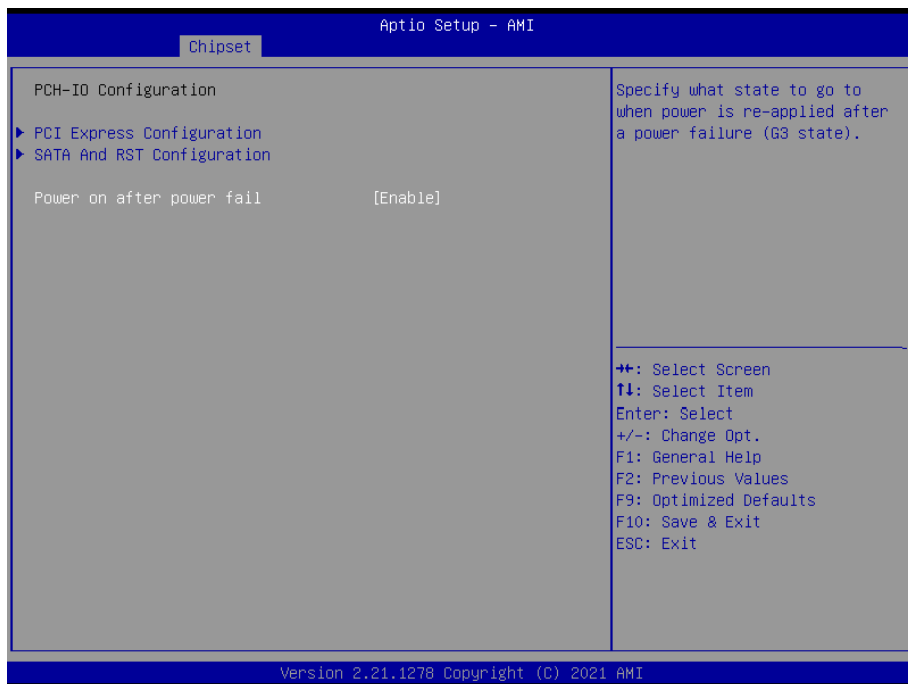

Setting	Description
PCI Express Configuration	See 5.3.2.1. PCI Express Configuration on page 64
SATA And RST Configuration	See 5.3.2.2. SATA And RST Configuration on page 82
Power on after power fail	Specify what state to go to when power is re-applied after a power failure (G3 state). ► Options available are Enable (default), Disable .

5.3.2.1. PCI Express Configuration

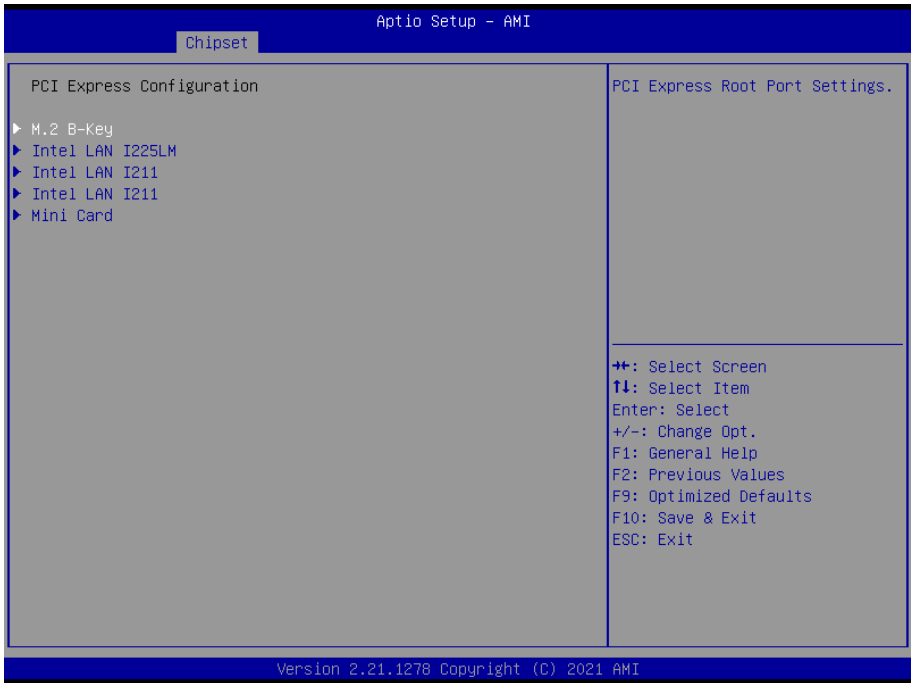

Setting	Description
M.2 B-key	PCI Express root port settings. Control the M.2 B-key root port.
Intel LAN I225LM	PCI Express root port settings. Control the LAN I225LM root port.
Intel LAN I211	PCI Express root port settings. Control the LAN I211 root port.
ASPM Support	Disable or set the ASPM level. Force L0s will force all inks to L0s state. "Auto" will allow BIOS to auto configure."Disable" will disable ASPM. ▶ Options: Disabled (default), L0s , L1 , L0sL1 and Auto .
PCIe Speed	Select PCI Express port speed. ▶ Options: Auto (default), Gen1 , Gen2 and Gen3

5.3.2.2. SATA And RST Configuration

The screenshot shows the 'Chipset' section of the BIOS setup. The title bar reads 'Aptio Setup - AMI'. The main area is titled 'SATA And RST Configuration' and lists several settings:

- SATA Controller(s): [Enabled]
- Aggressive LPM Support: [Enabled]
- Serial ATA Port 0: Empty
- Software Preserve: Unknown
- Port 0: [Enabled]
- SATA Port 0 DevSlp: [Disabled]
- Serial ATA Port 1: Empty
- Software Preserve: Unknown
- Port 1: [Enabled]
- SATA Port 1 DevSlp: [Disabled]

On the right side, there is a description: 'Enable/Disable SATA Device.' Below this, a list of navigation keys is provided:

- +/: Select Screen
- ↑↓: Select Item
- Enter: Select
- +/-: Change Opt.
- F1: General Help
- F2: Previous Values
- F9: Optimized Defaults
- F10: Save & Exit
- ESC: Exit

At the bottom of the screen, the text 'Version 2.21.1278 Copyright (C) 2021 AMI' is visible.

Setting	Description
SATA Controller(s)	Enables (default) / disables SATA device(s).
Aggressive LPM Support	Enables (default) / disables PCH to aggressively enter link power state.
SATA Mode Selection	Configures how SATA controller(s) operate. ► Options: AHCI (default) and Intel RST premium With Intel Optane System Acceleration .
Serial ATA Port 0/1	SATA device information. *Available SATA ports depend on your model.
Port 0/1	Enables (default) / disables the SATA port.
SATA Port 0/1 DevSlp	Enables / disables (default) the SATA port DevSlp. Board rework for LP needed before enable.

5.4. Security

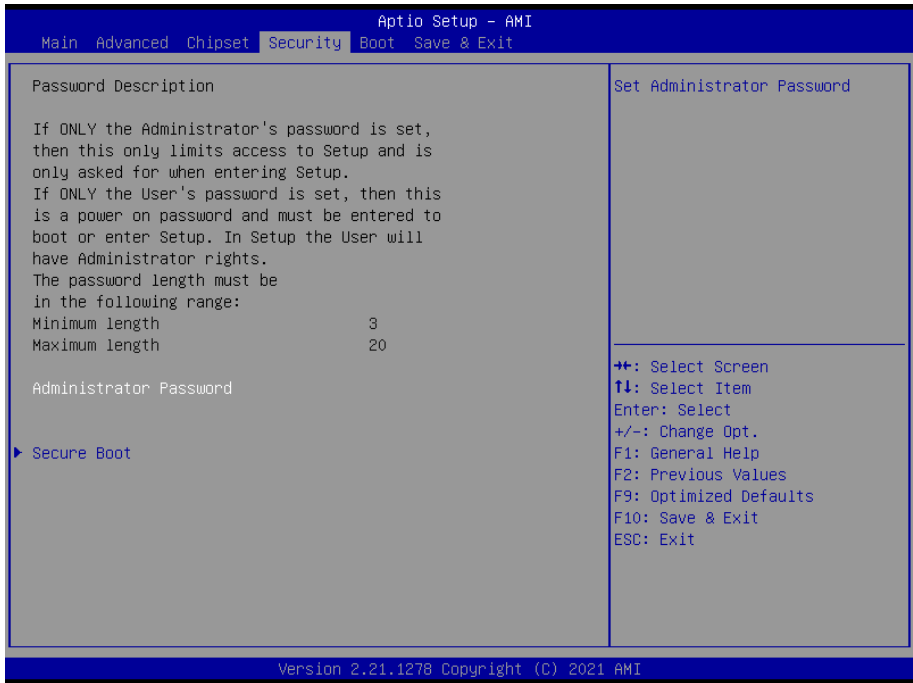

Setting	Description
Administrator Password	<p>To set up an administrator password:</p> <ol style="list-style-type: none"> 1. Select Administrator Password. 2. An Create New Password dialog then pops up onscreen. 3. Enter your desired password that is no less than 3 characters and no more than 20 characters. 4. Hit [Enter] key to submit.
Security Boot	See 5.4.1 Security Boot on page

5.4.1 Security Boot



Setting	Description
Secure Boot	Enable/Disable (default) secure boot.
Secure Boot Mode	Allow users to set the secure boot selector. Standard/Custom (default) mode.
Restore Factory Keys	Force system to restore default secure boot key database.
Reset to Setup Mode	Delete all secure boot key databases.
Key Management	Allow users to modify secure variables and set key management page.

5.5. Boot

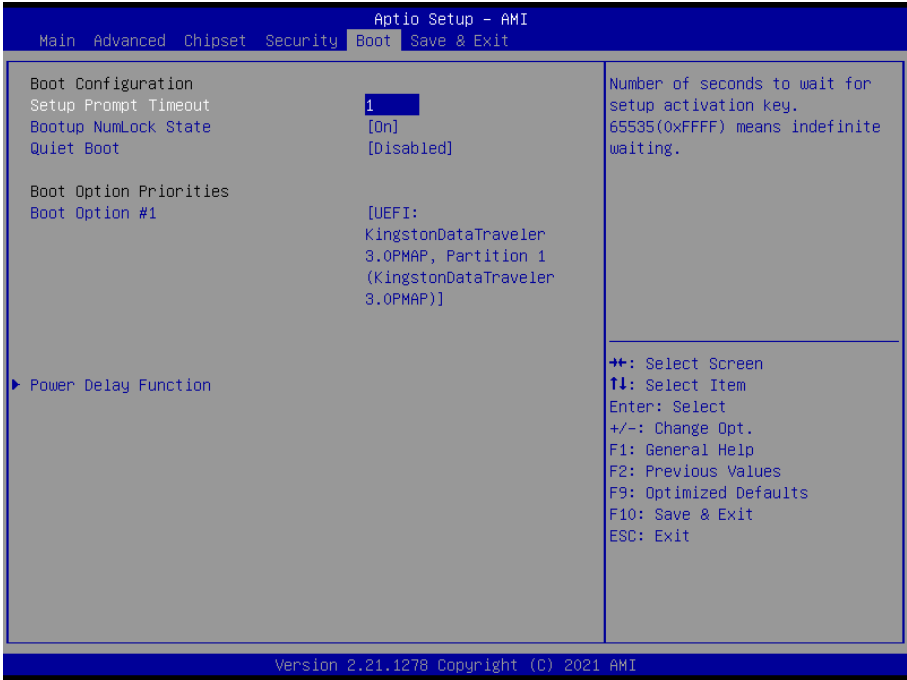

Setting	Description
Setup Prompt Timeout	Set how long to wait for the prompt to show for entering BIOS Setup. <ul style="list-style-type: none"> ▶ The default setting is 2 (sec). ▶ Set it to 65535 to wait indefinitely.
Bootup NumLock State	Sets whether to enable or disable the keyboard's NumLock state when the system starts up. <ul style="list-style-type: none"> ▶ Options available are On (default) and Off.
Quiet Boot	Sets whether to display the POST (Power-on Self Tests) messages or the system manufacturer's full screen logo during booting. <ul style="list-style-type: none"> ▶ Select Disabled to display the normal POST message, which is the default.
Boot Option Priority	Set the system boot priorities.

Power Delay Function	<p>Power Delay Function Set the system support power delay function.</p> <p>▶ Options: Enable (default): Support power delay function. Disable: Power on/off manually operated.</p> <p>Power on delay Select the time which the system will power on.</p> <p>▶ Options: Manually Operator (default), 04 Seconds, 08 Seconds and 16 Seconds.</p> <p>Power off delay Select the time which the system will shutdown.</p> <p>▶ Options: Manually Operator (default), 30 Seconds, 60 Seconds and 90 Seconds.</p>
-----------------------------	---

5.6. Save & Exit

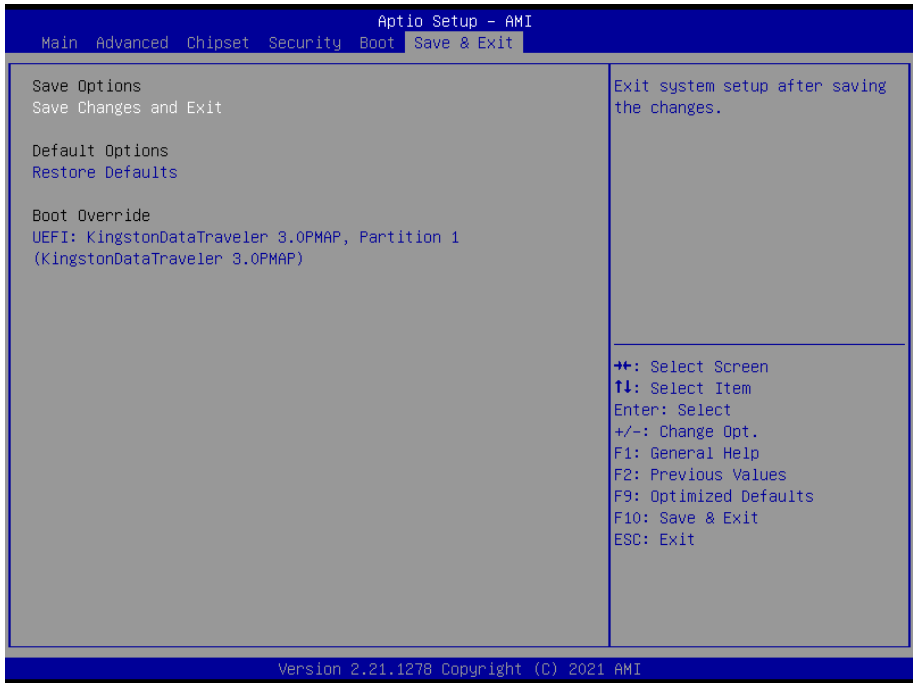

Setting	Description
Save Changes and Exit	Saves the changes and quits the BIOS Setup utility.
Restore Defaults	Restores all settings to defaults. <ul style="list-style-type: none"> ▶ This is a command to launch an action from the BIOS Setup utility.
Boot Override	Boot Override presents a list in context with the boot devices in the system. <ul style="list-style-type: none"> ▶ P0: Select the device to boot up the system regardless of the currently configured boot priority. ▶ Launch EFI Shell from filesystem device: Attempts to launch EFI Shell Application (Shell.efi) from one of the available filesystem devices.

Appendix

Appendix A. 16-bit DIO Signal Connections

A.1. Isolated Digital Input Connections

The input (IN-C) will accept supply voltages. Make sure the V_{on} (IN-C to IN) is more than 12V and V_{off} (IN-C to IN) is less than 5V. The following diagram shows the connection between outside signal and the system.

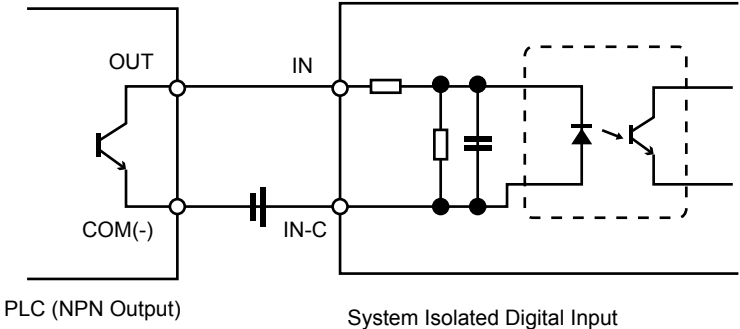

Note that the input's (IN-C) first and last pins are for VCC.

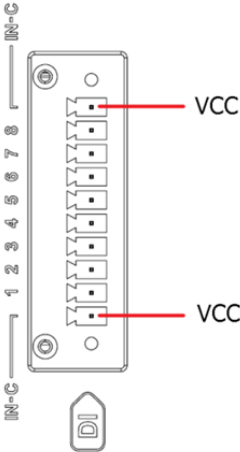

A.2. Isolated Digital Output Connections

When an isolated output channel is being used as an output channel, if an external voltage is applied, the current will flow from the external voltage source to the system. Make sure that the current through each out pin does not exceed 100 mA.

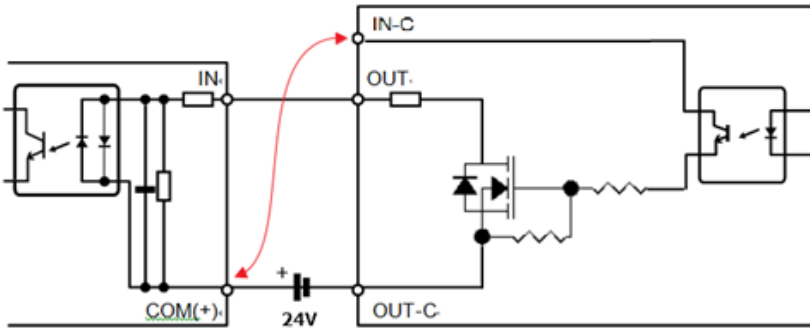

Note that the output's (OUT-C) first and last pins are for GND.

