



NEXCOM International

Mobile Computing Solutions

Vehicle Mount Display

VMD 3002

User Manual

NEXCOM International Co., Ltd.

Published May 2021

www.nexcom.com

Contents

Preface

Copyright Notice.....	iii
Disclaimer.....	iii
Acknowledgements.....	iii
Regulatory Compliance Statements.....	iii
Declaration of Conformity.....	iii

Warranty and RMA

NEXCOM Warranty Period.....	v
NEXCOM Return Merchandise Authorization (RMA).....	v
Headquarters.....	vi
Global Service Contact Information.....	vi

Ordering Information

Chapter 1: Product Introduction

Overview.....	1
Specifications.....	2
VMD 3002 Dimensions.....	3

Chapter 2: VMD 3002 Hardware Functionality

Front Panel & Rear Panel Functions.....	4
Back Panel & Pigtail Multi-IO Cable.....	5
Cable Pinout Diagram.....	6
Pin Assignment.....	7

Chapter 3: Hardware Installation

Assembling the Stand.....	8
Assembling the Brackets for Cables.....	9

Chapter 4: OSD Function

Menu Structure of the Screen Adjustment.....	14
OSD Menu Tree.....	15
OSD-PC Menu: Contrast, Brightness, Color Mode & Auto Config.....	16
OSD-System Menu: Duration & Information.....	18
OSD-Geometry Menu.....	19

Chapter 5: API of Controlling VMD 3002 - Initial Setup

Updating MCU Code.....	23
------------------------	----

Chapter 6: Table for MCU Protocol25

Preface

Copyright Notice

This publication, including all photographs, illustrations and software, is protected under international copyright laws, with all rights reserved. No part of this manual may be reproduced, copied, translated or transmitted in any form or by any means without the prior written consent from NEXCOM International Co., Ltd.

Disclaimer

The information in this document is subject to change without prior notice and does not represent commitment from NEXCOM International Co., Ltd. However, users may update their knowledge of any product in use by constantly checking its manual posted on our website: <http://www.nexcom.com>. NEXCOM shall not be liable for direct, indirect, special, incidental, or consequential damages arising out of the use of any product, nor for any infringements upon the rights of third parties, which may result from such use. Any implied warranties of merchantability or fitness for any particular purpose is also disclaimed.

Acknowledgements

VMD 3002 is a trademark of NEXCOM International Co., Ltd. All other product names mentioned herein are registered trademarks of their respective owners.

Regulatory Compliance Statements

This section provides the FCC compliance statement for Class B devices and describes how to keep the system CE compliant.

Declaration of Conformity

FCC

This equipment has been tested and verified to comply with the limits for a Class B digital device, pursuant to Part 15 of FCC Rules. These limits are designed to provide reasonable protection against harmful interference when the equipment is operated in a commercial environment. This equipment generates, uses, and can radiate radio frequency energy and, if not installed and used in accordance with the instructions, may cause harmful interference to radio communications. Operation of this equipment in a residential area (domestic environment) is likely to cause harmful interference, in which case the user will be required to correct the interference (take adequate measures) at their own expense.

CE

The product(s) described in this manual complies with all applicable European Union (CE) directives if it has a CE marking. For computer systems to remain CE compliant, only CE-compliant parts may be used. Maintaining CE compliance also requires proper cable and cabling techniques. and, if not installed and used in accordance with the instruction manual, may cause harmful interference to radio communications.

RoHS Compliance

NEXCOM RoHS Environmental Policy and Status Update



NEXCOM is a global citizen for building the digital infrastructure. We are committed to providing green products and services, which are compliant with European Union RoHS (Restriction on Use of Hazardous Substance in Electronic Equipment) directive 2011/65/EU, to be your trusted green partner and to protect our environment.

RoHS restricts the use of Lead (Pb) < 0.1% or 1,000ppm, Mercury (Hg) < 0.1% or 1,000ppm, Cadmium (Cd) < 0.01% or 100ppm, Hexavalent Chromium (Cr6+) < 0.1% or 1,000ppm, Polybrominated biphenyls (PBB) < 0.1% or 1,000ppm, and Polybrominated diphenyl Ethers (PBDE) < 0.1% or 1,000ppm.

In order to meet the RoHS compliant directives, NEXCOM has established an engineering and manufacturing task force in to implement the introduction of green products. The task force will ensure that we follow the standard NEXCOM development procedure and that all the new RoHS components and new manufacturing processes maintain the highest industry quality levels for which NEXCOM are renowned.

How to Recognize NEXCOM RoHS Products

For existing products where there are non-RoHS and RoHS versions, the suffix "(LF)" will be added to the compliant product name.

All new product models launched after January 2013 will be RoHS compliant. They will use the usual NEXCOM naming convention.

Installation Recommendations

Ensure you have a stable, clean working environment. Dust and dirt can get into components and cause a malfunction. Use containers to keep small components separated.

Adequate lighting and proper tools can prevent you from accidentally damaging the internal components. Most of the procedures that follow require only a few simple tools, including the following:

- A Philips screwdriver
- A flat-tipped screwdriver
- A grounding strap
- An anti-static pad

Using your fingers can disconnect most of the connections. It is recommended that you do not use needlenose pliers to disconnect connections as these can damage the soft metal or plastic parts of the connectors.

Handling Precautions

- Always disconnect the unit from the power outlet whenever you are installing or fixing a component inside the chassis.
- If possible, always wear a grounded wrist strap when you are installing or fixing a component inside the chassis. Alternatively, discharge any static electricity by touching the bare metal chassis of the unit case, or the bare metal body of any other grounded appliance.
- Hold electronic circuit boards by the edges only. Do not touch the components on the board unless it is necessary to do so. Do not flex or stress the circuit board.
- Use the correct screws and do not overly tighten them.
- Keep the original packaging and static-protective bag in case the unit has to be returned.

Warranty and RMA

NEXCOM Warranty Period

NEXCOM manufactures products that are new or equivalent to new in accordance with industry standard. NEXCOM warrants that products will be free from defect in material and workmanship for 24 months beginning on the date of invoice by NEXCOM.

NEXCOM Return Merchandise Authorization (RMA)

- Customers shall enclose the “NEXCOM RMA Service Form” with the returned packages.
- Customers must collect all the information about the problems encountered and note anything abnormal or, print out any on-screen messages, and describe the problems on the “NEXCOM RMA Service Form” for the RMA number apply process.
- Customers can send back the faulty products with or, without accessories (manuals, cables, etc.) and any unnecessary components from the card, such as CPU and DRAM. If the components were suspected as part of the problems, please note clearly that which components are included. Otherwise, NEXCOM is not responsible for the devices/parts.
- Customers are responsible to for the safe packaging of defective products are durable enough to be resistant against further damage and deterioration during transportation. In case of damages occurred during the transportation, the repair is treated as “Out of Warranty.”
- Any products returned by NEXCOM to other locations besides the customers’ site will bear an extra charge and will be billed to the customer.

Repair Service Charges for Out-of-Warranty Products

NEXCOM will charge for out of warranty products in two categories, one is basic diagnostic fee and another is component (product) fee.

System Level

- Component fee: NEXCOM will only charge for main components, such as SMD chip, BGA chip, etc. Passive components will be repaired for free, ex: resistor, capacitor.
- Items will be replaced with NEXCOM products if the original one is not able to be repaired. Ex: motherboard, power supply, etc.
- Replaced with 3rd party products if needed.
- If RMA goods cannot be repaired, NEXCOM will return it to customer without any charge.

Board Level

- Component fee: NEXCOM will only charge for main components, such as SMD chip, BGA chip, etc. Passive components will be repaired for free, ex: resistors, capacitors.
- If RMA goods can not be repaired, NEXCOM will return it to customer without any charge.

Global Service Contact Information

Headquarters

NEXCOM International Co., Ltd.

9F, No. 920, Chung-Cheng Rd.,
Zhonghe District, New Taipei City, 23586,
Taiwan, R.O.C.
Tel: +886-2-8226-7786
Fax: +886-2-8226-7782
www.nexcom.com

Asia

Taiwan

NexAIoT Headquarters

Industry 4.0 and Cloud Services

13F, No.916, Zhongzheng Rd.,
Zhonghe District, New Taipei City,
23586, Taiwan, R.O.C.
Tel: +886-2-8226-7796
Fax: +886-2-8226-7926
Email: sales@nexaiot.com
www.nexaiot.com

NexAIoT Co., Ltd.

Taichung Office

16F, No.250, Sec. 2, Chongde Rd.,
Beitun District,
Taichung City, 406, Taiwan, R.O.C.
Tel: +886-4-2249-1179
Fax: +886-4-2249-1172
Email: sales@nexaiot.com
www.nexaiot.com

NexCOBOT Taiwan Co., Ltd.

13F, No.916, Chung-Cheng Rd.,
Zhonghe District,
New Taipei City, 23586, Taiwan, R.O.C.
Tel: +886-2-8226-7786
Fax: +886-2-8226-7926
Email: sales@nexcobot.com
www.nexcobot.com

GreenBase Technology Corp.

13F, No.922, Chung-Cheng Rd.,
Zhonghe District,
New Taipei City, 23586, Taiwan, R.O.C.
Tel: +886-2-8226-7786
Fax: +886-2-8226-7900
Email: sales@nexcom.com.tw
www.nexcom.com.tw

EMBOX Technology Co., Ltd.

13F, No.916, Chung-Cheng Rd.,
Zhonghe District,
New Taipei City, 23586, Taiwan, R.O.C.
Tel: +886-2-8226-7786
Fax: +886-2-8226-7782
Email: sales@nexcom.com.tw
www.nexcom.com.tw

TMR Technology Corp.

13F, No.916, Chung-Cheng Rd.,
Zhonghe District,
New Taipei City, 23586, Taiwan, R.O.C.
Tel: +886-2-8226-7786
Fax: +886-2-8226-7782
Email: sales@nexcom.com.tw
www.nexcom.com.tw

China

NEXSEC Incorporated

5F, No.4, No.7 Fengxian Middle Rd.,
(Beike Industrial Park), Haidian District,
Beijing, 100094, China
Tel: +86-10-5704-2680
Fax: +86-10-5704-2681
Email: marketing@nexsec.cn
www.nexsec.cn

NEXCOM Shanghai

No.4, 16 Building,
Shanghai OMNI Tech & Science Park
No. 1699, Douhui Rd.,
Shanghai, 201108, China
Tel: +86-21-5278-5868
Fax: +86-21-3251-6358
Email: sales@nexcom.cn
www.nexcom.cn

NEXCOM Surveillance Technology Corp.

5F, Building C, ZhenHan Industrial Zone,
GanKeng Community, Buji Street,
LongGang District,
ShenZhen, 518112, China
Tel: +86-755-8364-7768
Fax: +86-755-8364-7738
Email: steveyang@nexcom.com.tw
www.nexcom.cn

NEXCOM United System Service

Room 603/604, Huiyinmingzun Plaza Bldg. 1,
No. 609, Yunlin East Rd.,
Shanghai, 200062, China
Tel: +86-21-5278-5868
Fax: +86-21-3251-6358
Email: renwang@nexcom.com.tw
www.nexcom.cn

NEXGOL Chongqing

1F, Building B4, Electronic 2nd Area,
(Phoenix Lake Industrial Park), Yongchuan Dist.,
Chongqing City, 402160, China
Tel: +86-23-4960-9080
Fax: +86-23-4966-5855
Email: sales@nexgol.com.cn
www.nexcobot.com/NexGOL

NexCOBOT China

Room 501, Building 1, Haichuang Building,
No.7 Qingyi Road, Guicheng Street,
Nanhai District, Foshan City,
Guangdong Province, 528314, China
Tel: +86-757-8625-7118
Email: sales@nexcobot.com
www.nexcobot.com.cn

Beijing NexGemo Technology Co.,Ltd.

5F, Gemotech Building, No.1, Development Rd.,
Changping International Information Industry Base,
Changping District,
Beijing, 102206, China
Tel: +86-10-8190-9328
Fax: +86-10-8190-9456
Email: sales@gemotech.cn
www.nexgemo.cn

Japan

NEXCOM Japan

9F, Tamachi Hara Bldg.,
4-11-5, Shiba Minato-ku,
Tokyo, 108-0014, Japan
Tel: +81-3-5419-7830
Fax: +81-3-5419-7832
Email: sales@nexcom-jp.com
www.nexcom-jp.com

America

USA NEXCOM USA

46665 Fremont Blvd.,
Fremont CA 94538, USA
Tel: +1-510-656-2248
Fax: +1-510-656-2158
Email: sales@nexcom.com
www.nexcomusa.com

NexCOBOT USA

2883 Bayview Drive,
Fremont CA 94538, USA
Tel: +1-510-362-0800
Fax: +1-510-656-2158
Email: sales@nexcobot.com
www.nexcobot.com

Europe

United Kingdom NEXCOM EUROPE

10 Vincent Avenue,
Crownhill Business Centre,
Milton Keynes, Buckinghamshire
MK8 0AB, United Kingdom
Tel: +44-1908-267121
Fax: +44-1908-262042
Email: sales.uk@nexcom.eu
www.nexcom.co.uk

Ordering Information

The following provides ordering information for VMD 3002.

- **VMD 3002-BS2 (P/N: 10VD0300205X0)**
10.4" XGA vehicle mount display with touch screen, VGA and CVBS Interfaces
- **Bundle Accessories**

Part Number	Description
6030000043X00	External 50-pin Multi-I/O Cable, L=1120mm
602DCD0779X00	Driver CD

Chapter 1: Product Introduction

Overview

VMD 3002 is a robust 10.4-inch TFT LCD monitor with enhanced brightness, projected capacitive touchscreen, and high performance loud speaker. It is designed with a single cable to consolidate power, display, and other control signal to ease the installation and secure the connection. It also features four analog video inputs to feed the real time video from the rear view cameras to the display. VMD 3002 mechanical design is compliant with IP65. With the 1000nits ultra high brightness display and adaptive brightness control, it is an ideal solution for in-vehicle and outdoor



Specifications

General

- Enclosure: Plastic PC + ABS
- Mounting: Support VESA 75/100
- Power Input: 9~36VDC
- Power Consumption: 18W
- Ingress Protection: IP65
- Dimension: 256.5 x 202.1 x 31.5 mm
- Weight: 1.64kg, 4.16lb

LCD Panel

- 10.4-inch TFT LCD panel with LED backlight
- 1024 x 768 pixels (XGA)
- Brightness: 1200 cd/m² (typical, after touch screen is 1080cd/m²)
- Viewing Angle: 170° (H):170°(V)
- Contrast Ratio: 900:1 (typical)

Touch Screen Sensor

- Projected capacitive touchscreen
- Surface Hardness: 6H
- Multiple touch

I/O Interface-Front

- 1x LED indicators (Power on/off, Auto Back-light, MCU update)
- IR remote sensor
- 2x Built-in 1W 8ohm speakers

I/O Interface-Lateral

- On screen display buttons x 7
- Display power on/off

- OSD Menu
- Volume control (+/-)
- Brightness control (+/-)
- Auto Configuration

I/O Interface-Bottom

- Pigtail with multiple IO interface
- 4x CVBS connector
- 1x Line-in
- 1x VGA
- 1x USB
- 1x COM (TX/RX)
- 1x Power input connector (9 ~ 36VDC)

Environment

- Operating temperature: -20°C to 60°C
- Storage temperature: -30°C to 80°C
- Vibration (random): 2.5g@5~500 Hz
- Vibration
 - Operating: MIL-STD-810G, 514.6 Procedure 1, Category 4, Ground Vehicle – Highway Truck
 - Storage: MIL-STD-810G, 514.6 Procedure 1, Category 4, Integrity Test
- Shock
 - Operating: MIL-STD-810G, Method 516.6, Procedure I, Trucks and semi-trailers= 20g
 - Crash hazard: MIL-STD-810G, Method 516.6, Procedure V, Ground equipment= 75g

Standards/ Certifications

- CE approval
- FCC Class B

VMD 3002 Dimensions

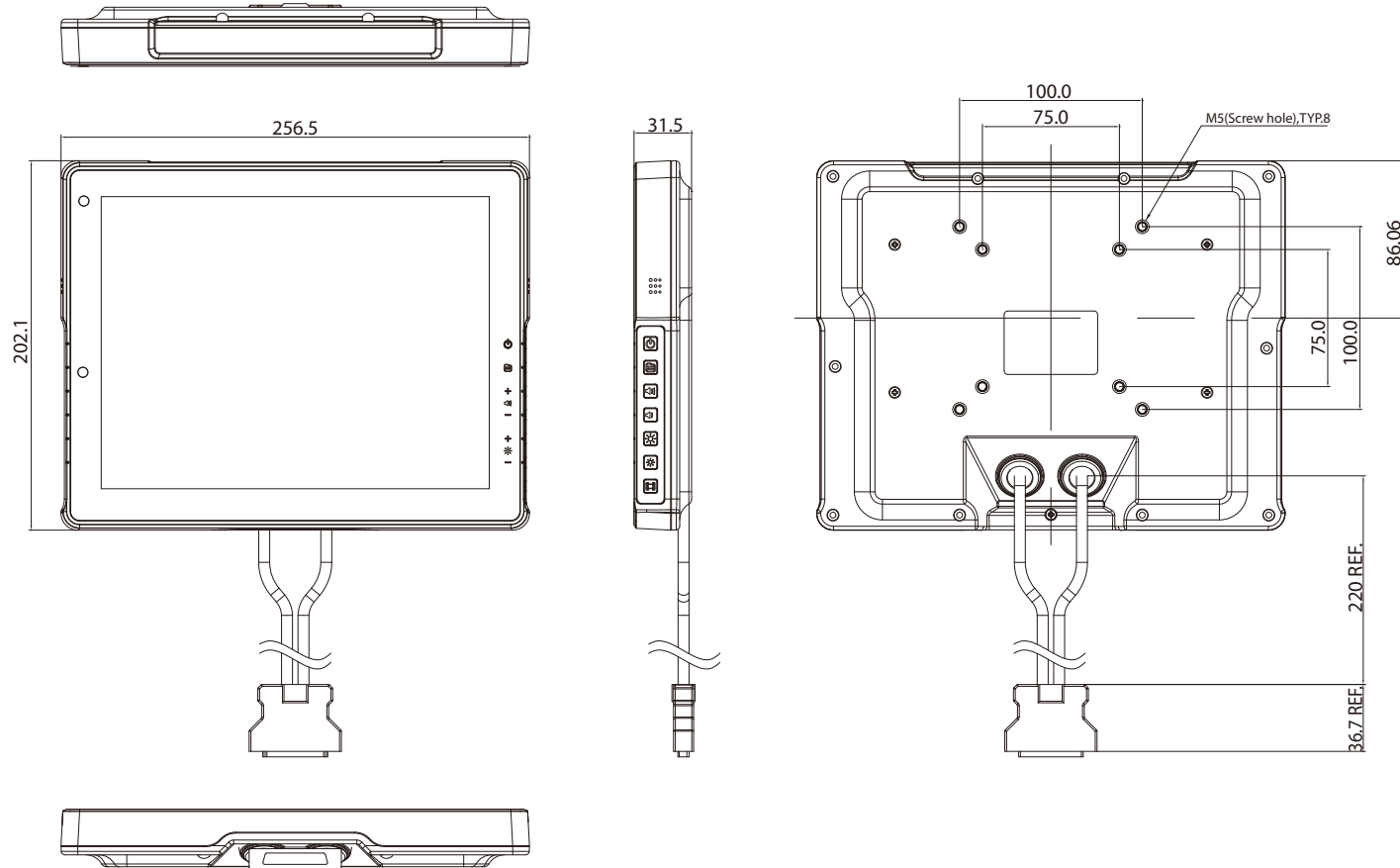

Chapter 2: VMD 3002 Hardware Functionality

Front Panel & Rear Panel Functions

Front Panel



- 1** **LED indicator**
Power on/off
Auto back-light
MCU update
- 2** **Power button to turn on/off the display monitor.**
Press the power button for 5 seconds to power off the PC system.
- 3** **Menu**
- 4** **Volume up**
- 5** **Volume down**
- 6** **Brightness up**
- 7** **Brightness down**
- 8** **Auto configuration**

Back Panel & Pigtail Multi-IO Cable



- 1. VESA 75/100 Mounting
- 2. Connector for Multi-IO Interface
- 3. Pigtail Multi-IO Cable
- 4. CVBS Connector x 4
- 5. Power Connector
- 6. COM Port
- 7. VGA
- 8. Line-in
- 9. USB Touch

Cable Pinout Diagram

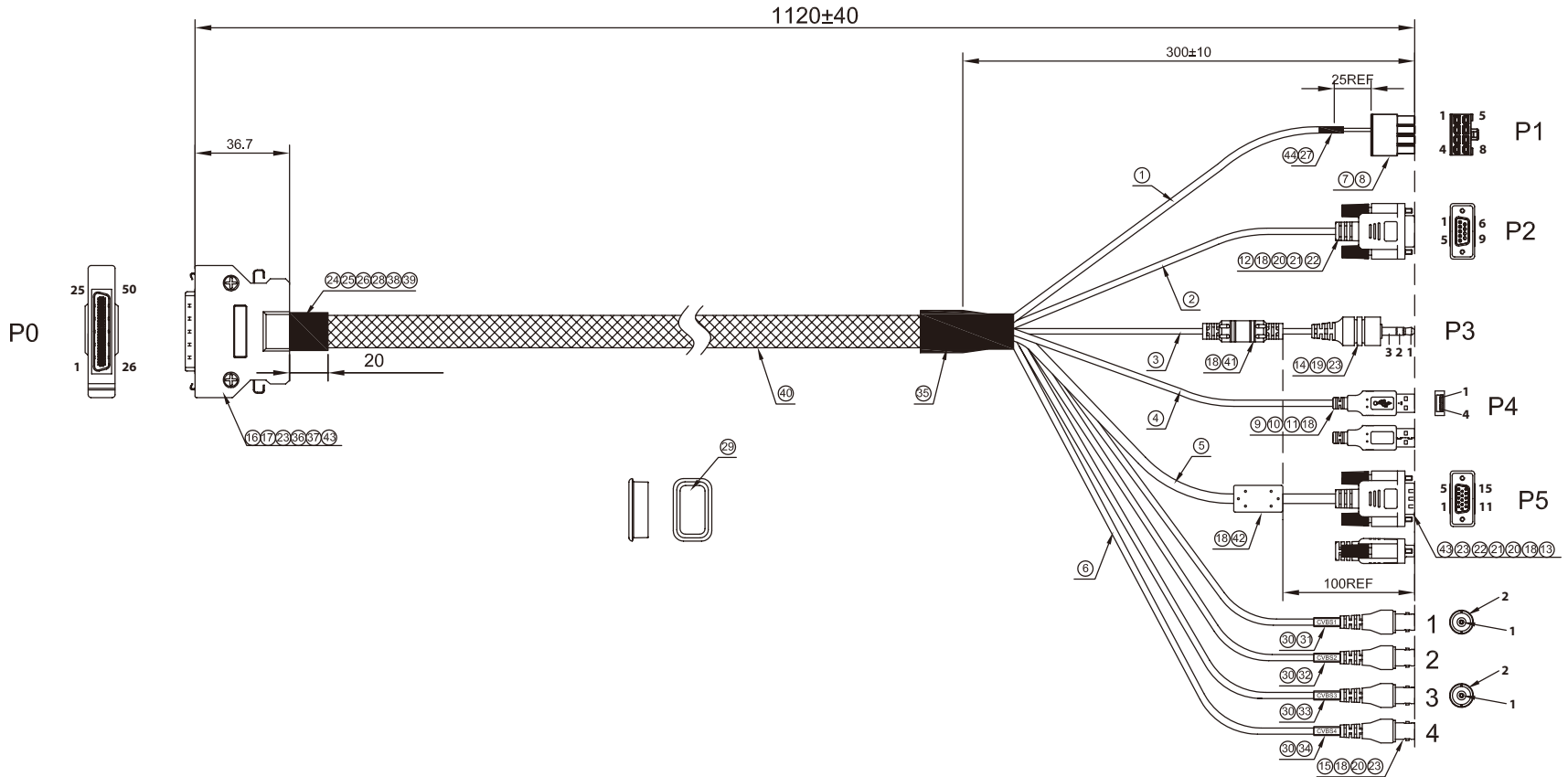

Pin Assignment

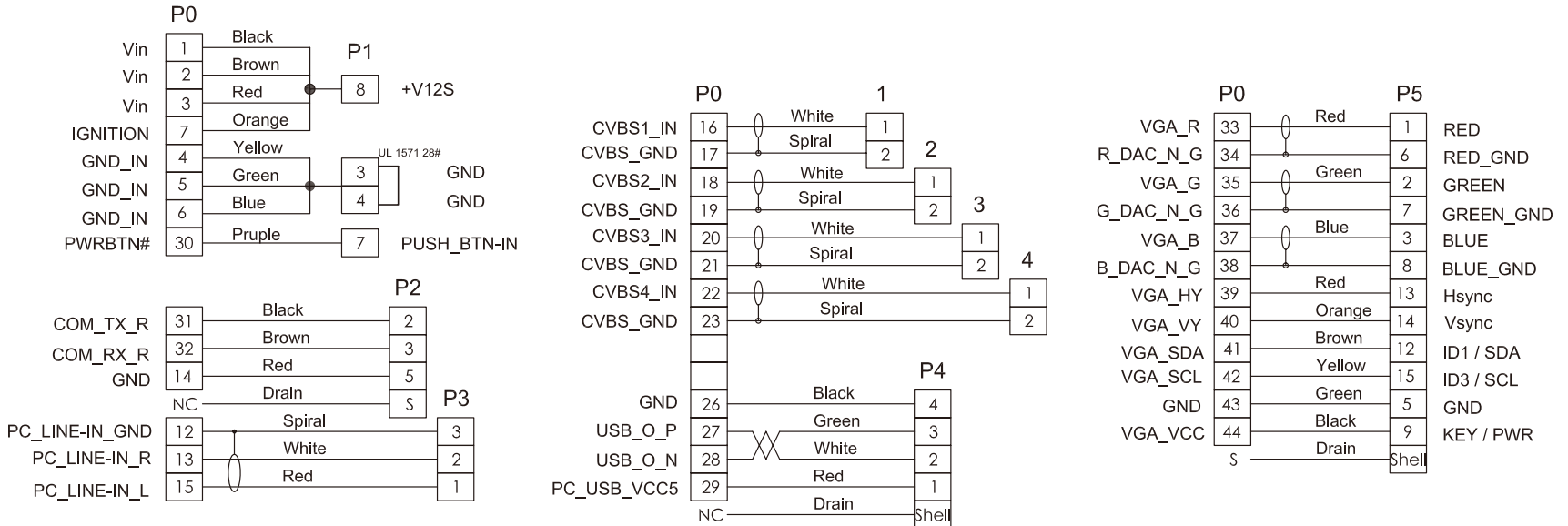

Chapter 3: Hardware Installation

Assembling the Stand

NOTE: Optional kit.

1. Fasten the black metal plate onto the rear panel with the 4 screws.

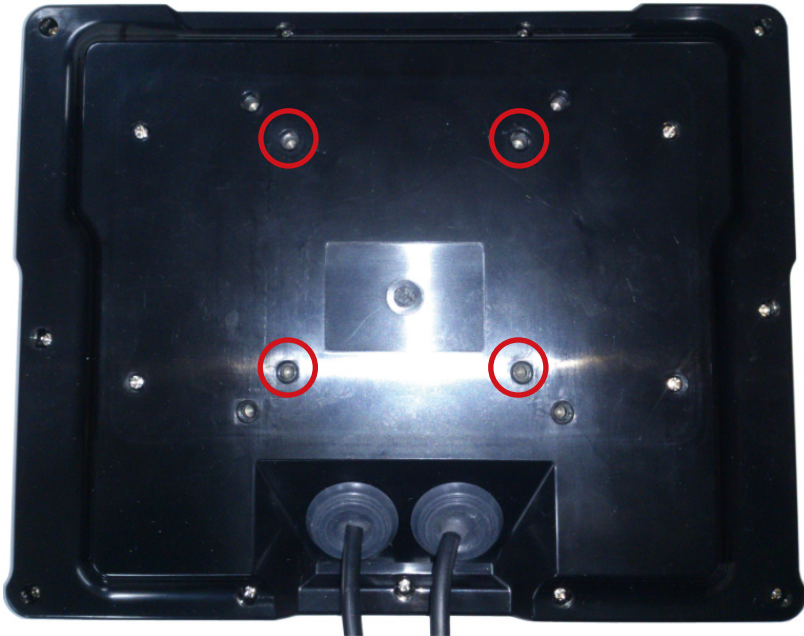

2. Attach and fasten the LCD panel onto the monitor stand.



Assembling the Brackets for Cables

1. Retrieve the brackets for the cables and screws from the package.



2. Connect the cable connector #2 and cable connector #3 together.

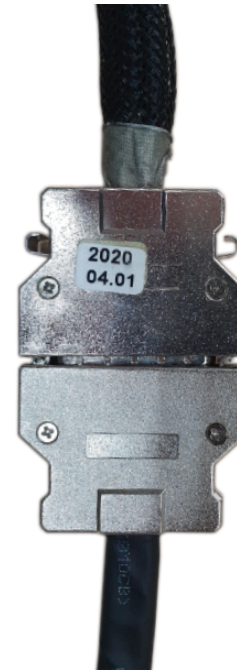
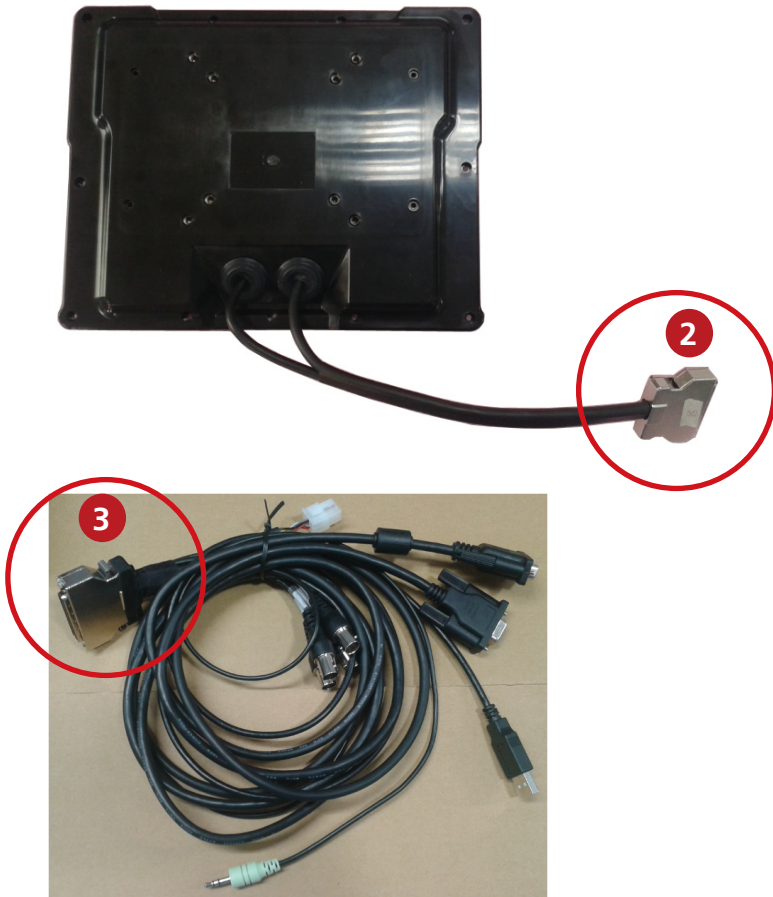

3. Place the cable connectors into the bracket.

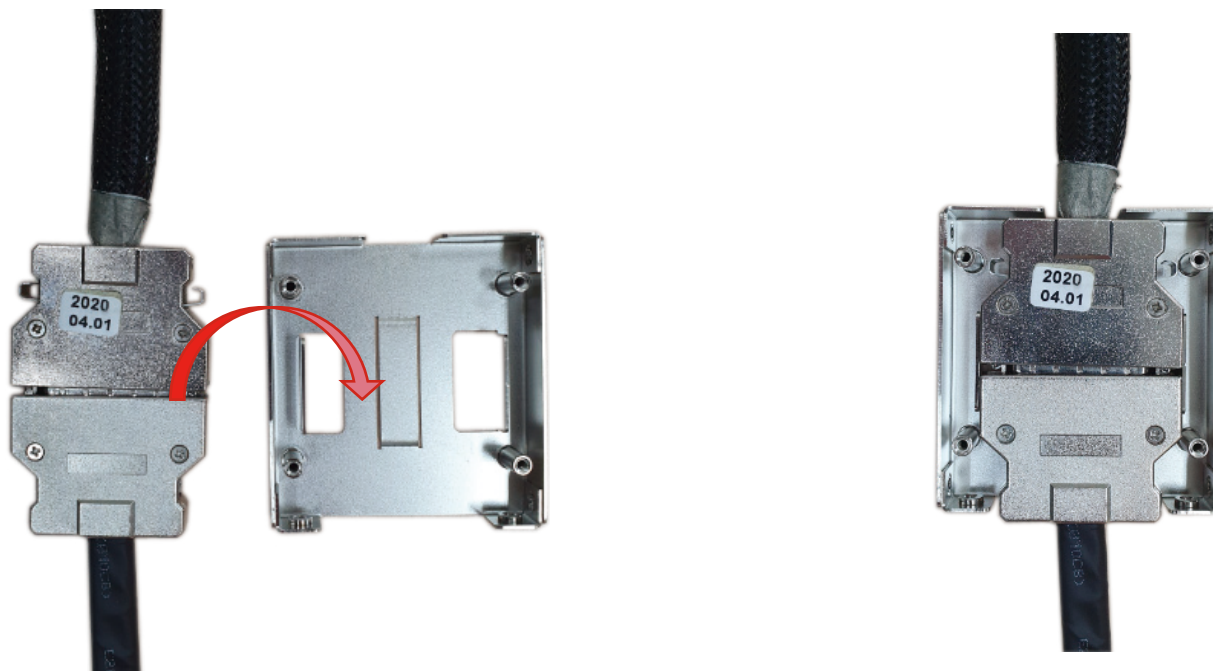

4. Place the outer covering on top of the bracket.

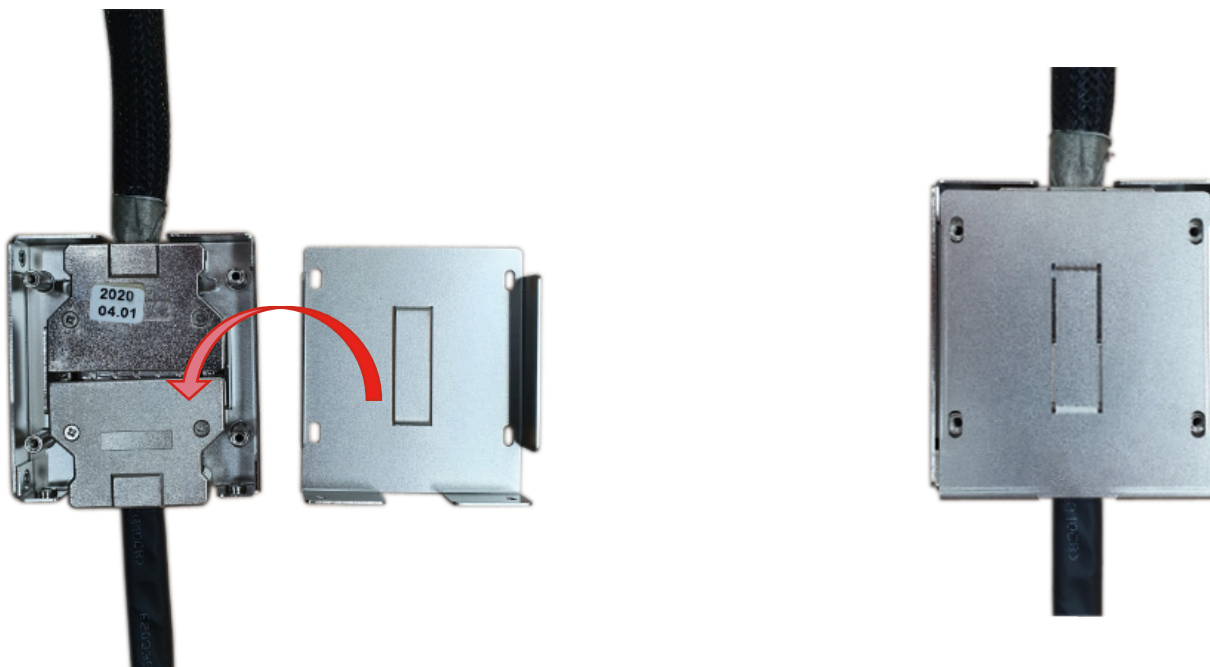

5. Fasten 2 screws on the side of the bracket.

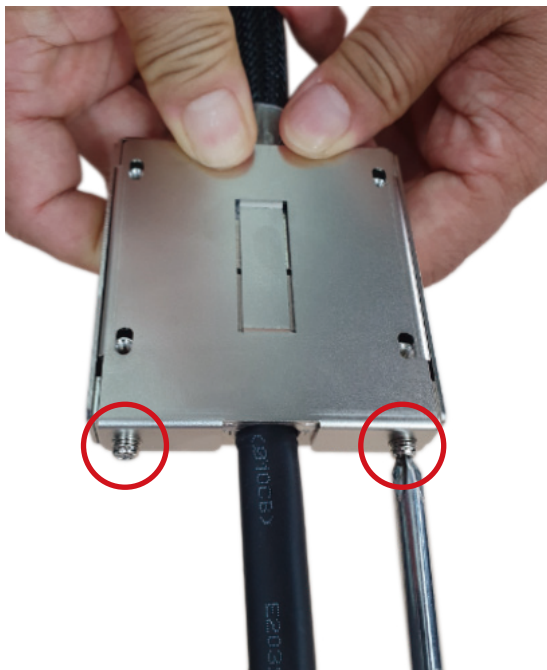

6. Fasten the outer covering with 4 screws.

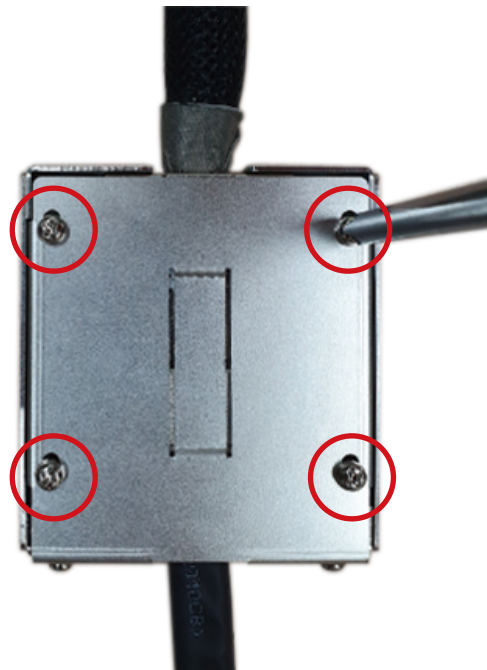

Chapter 4: OSD Function

Menu Structure of the Screen Adjustment

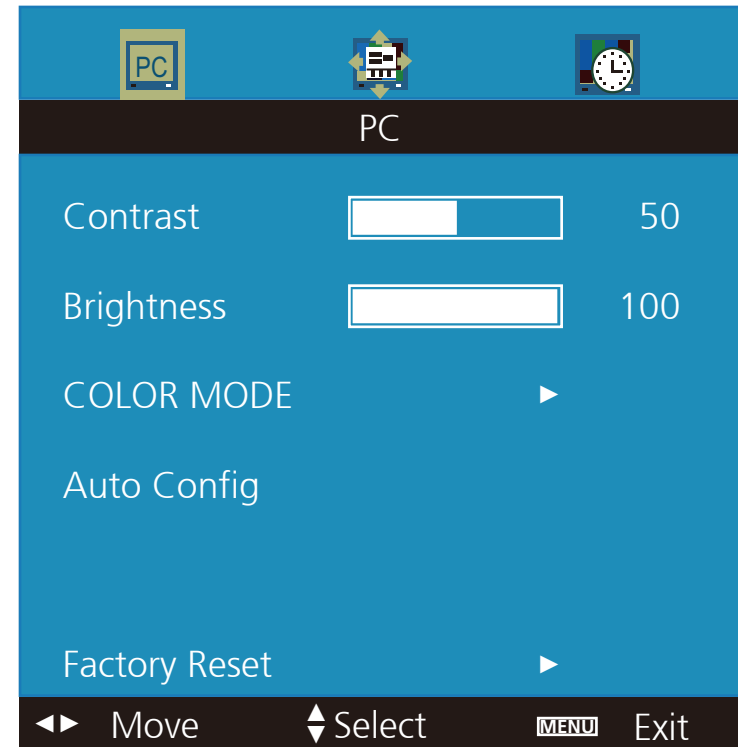
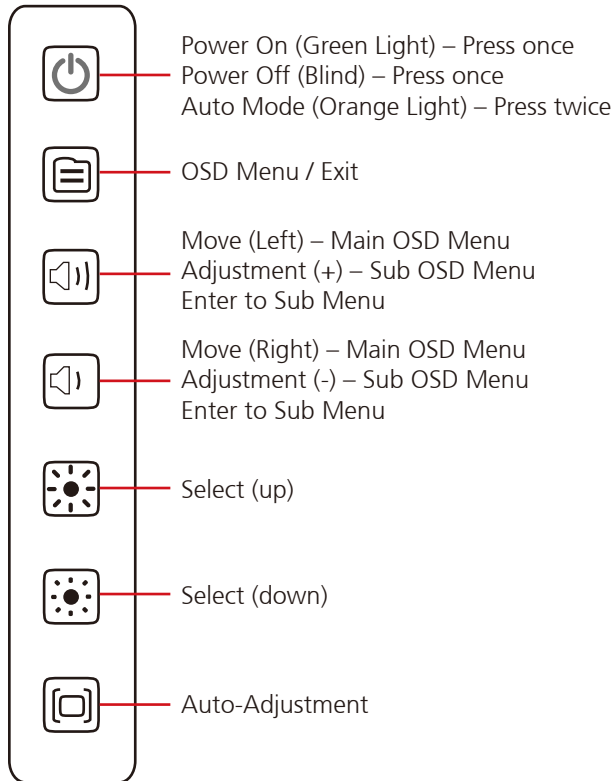

OSD Menu Tree

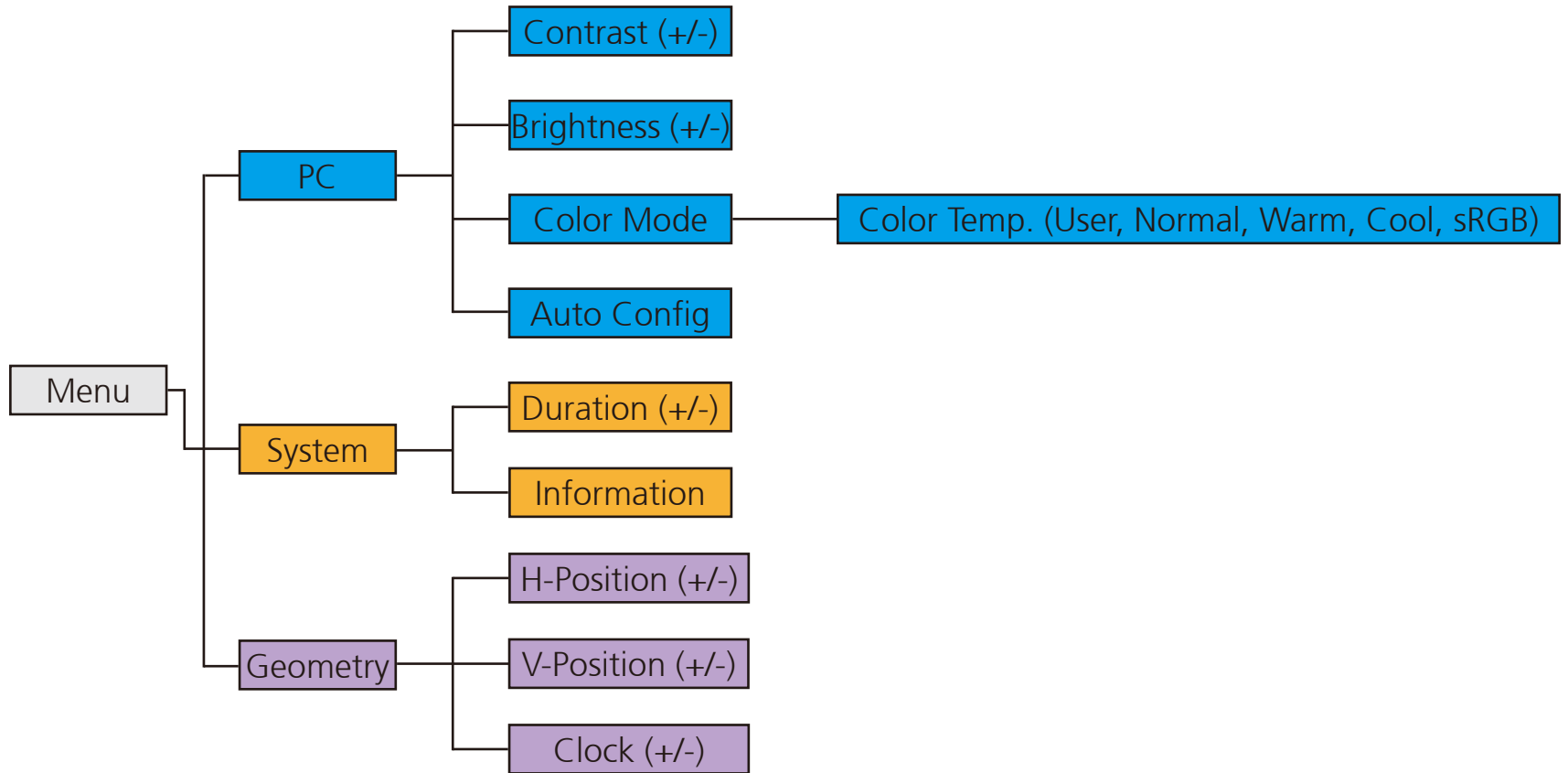

OSD-PC Menu: Contrast, Brightness, Color Mode & Auto Config

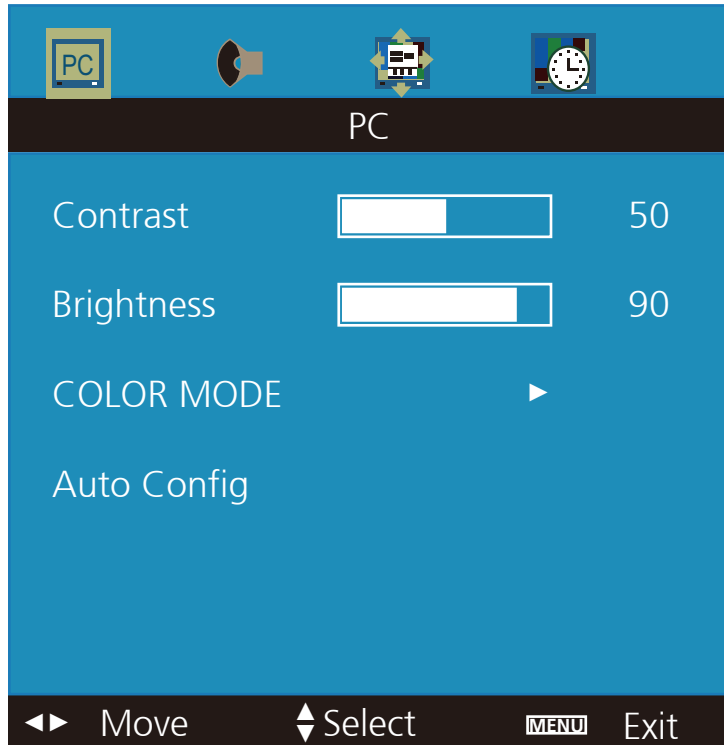

Menu	Description
Brightness	Adjusts the brightness of the display
Contrast	Adjusts the contrast of the display

Menu	Description
Auto Config	Automatically adjusts every parameter



Menu	Description
Color Temp	Adjusts the color temperature of the display

OSD-System Menu: Duration & Information

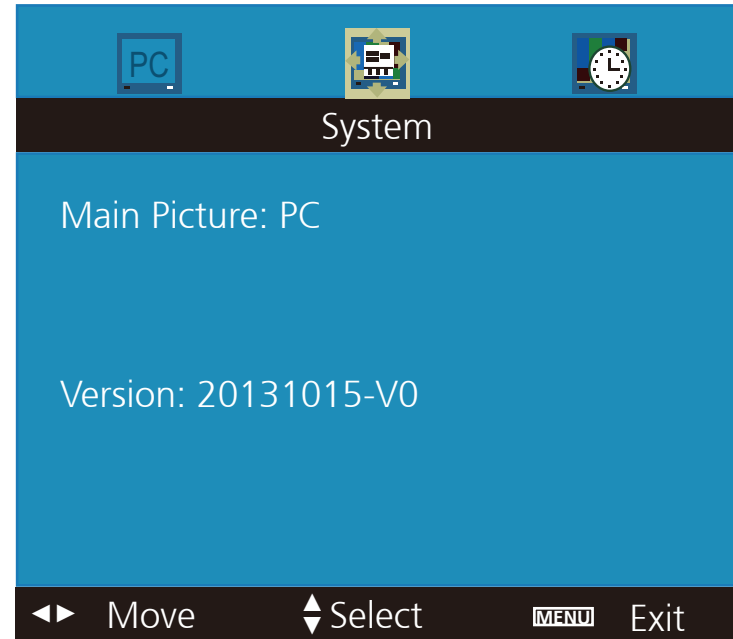
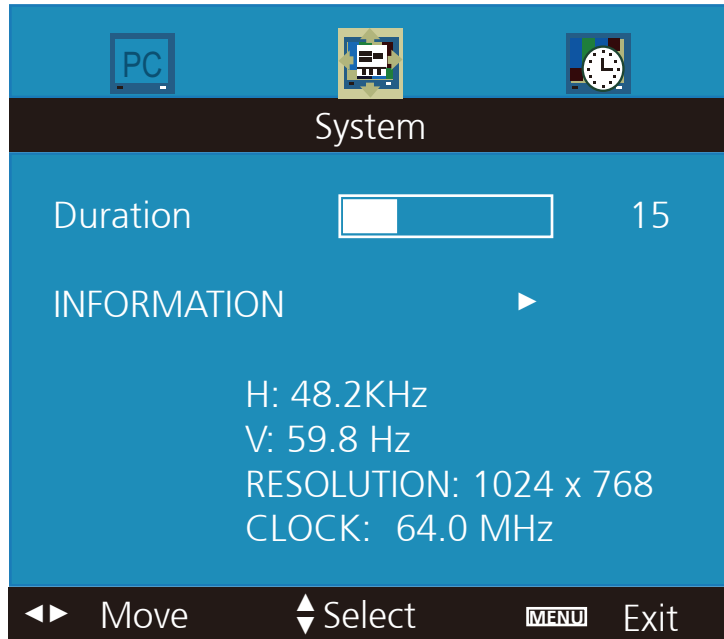

Menu	Description
Duration	Adjusts duration

Menu	Description
Information	Shows display information

OSD-Geometry Menu

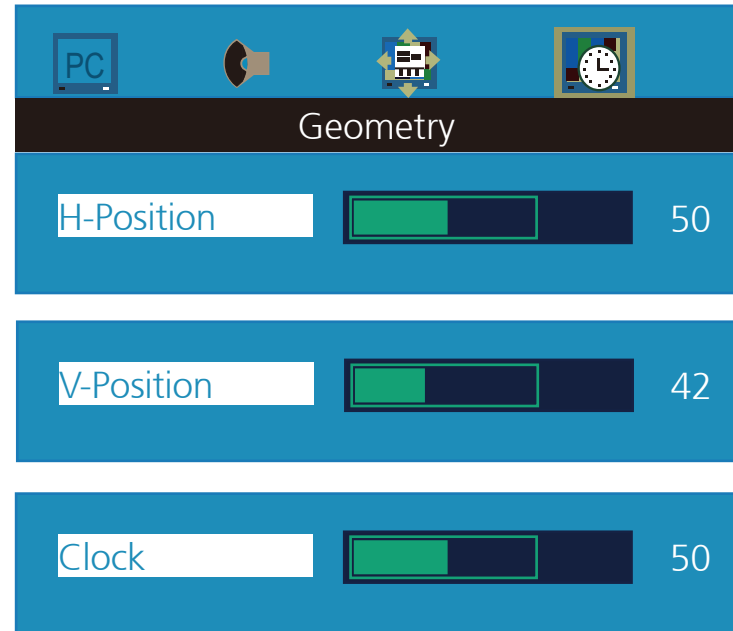
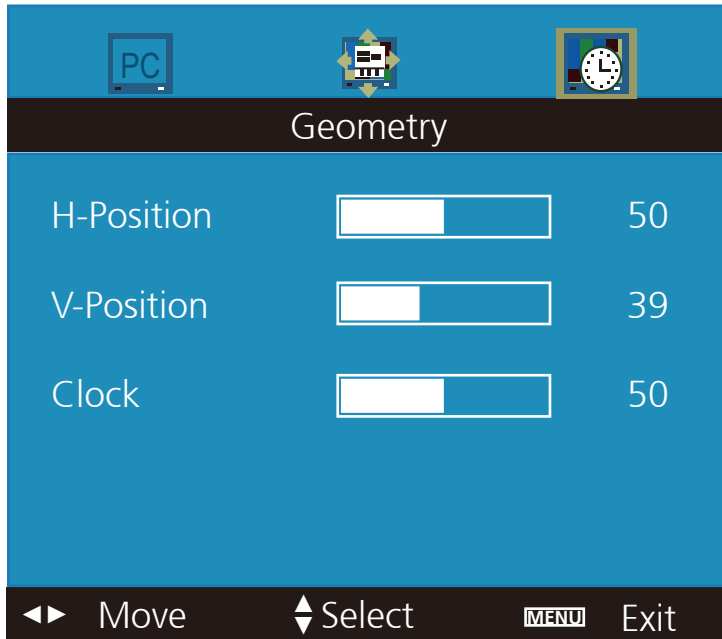

Menu	Description
H-Position	Moves the position of the OSD Menu in horizontal direction
V-Position	Moves the position of the OSD Menu in vertical direction
Clock	Adjusts the clock of display

Chapter 5: API of Controlling VMD 3002 - Initial Setup

1. Select COM port (COM1 to COM6).

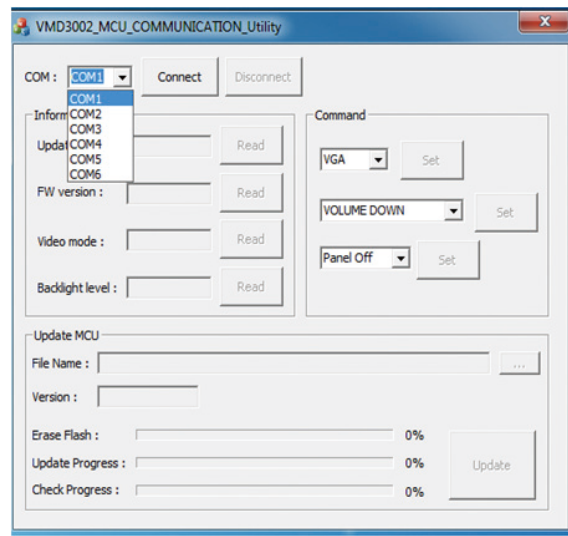

2. Click on "Connect".

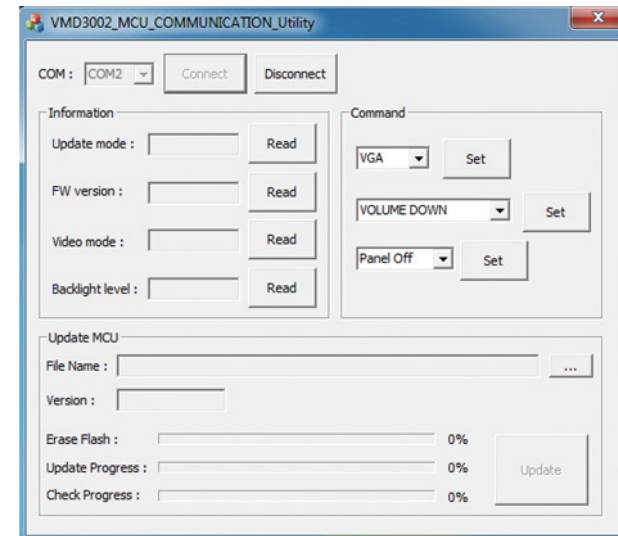

3. The information from VMD 3002 will be displayed.

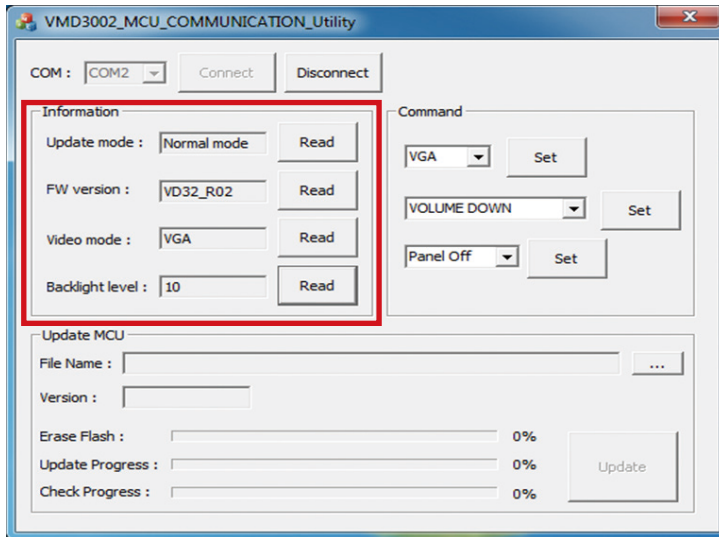

4. Switching the Input Source: Select the input source you want to use, then press "Set" to switch to that input source.

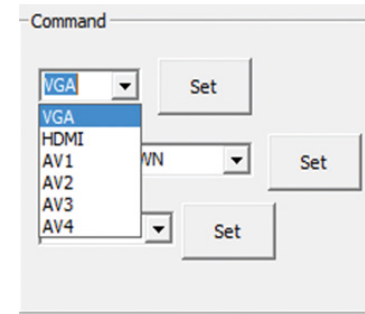

5. Controlling the Function from Lateral Membrane Key: Select the item that you want to control, then press "Set" to apply the function.

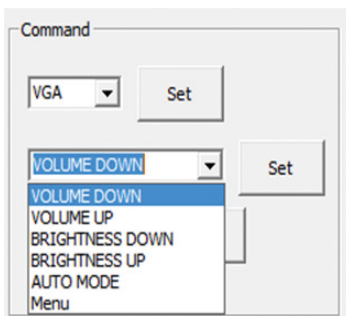

6. On/Off Panel:
Select "Panel Off" then press "Set" to turn off panel backlight.
Select "Panel On" then press "Set" to turn on panel backlight.

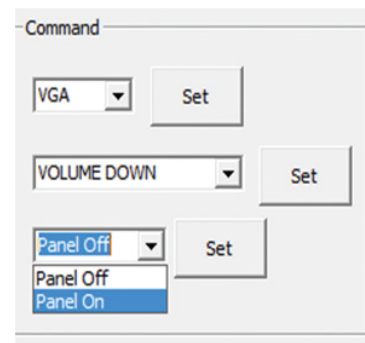

Updating MCU Code

1. Locate the firmware file and click on “Open”.

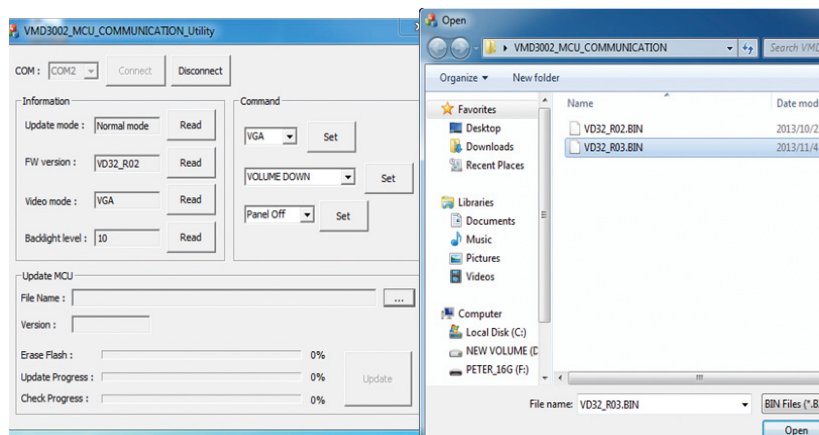

2. Click on “Update” once the correct firmware file is chosen.

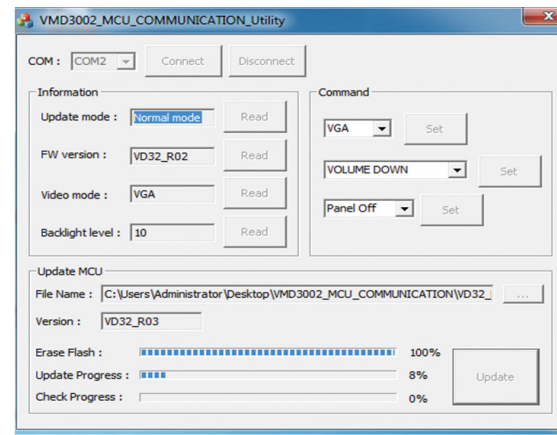

3. A system pop-up message will appear once the update is completed.

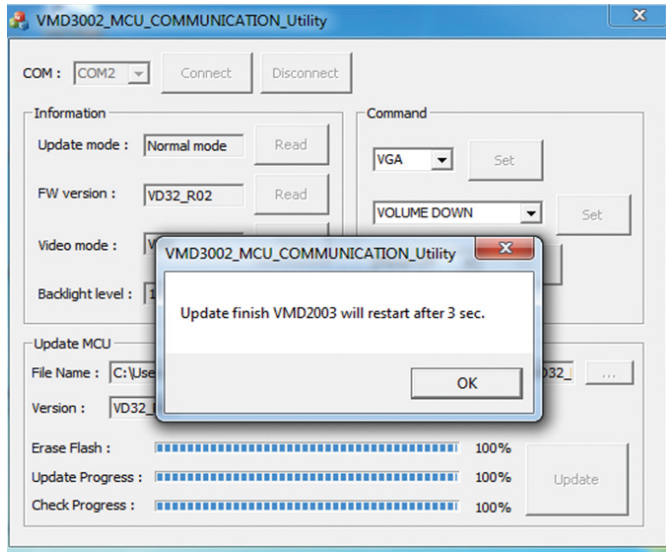

4. Click on the "Read" button next to the FW version textbox to check the new firmware version.

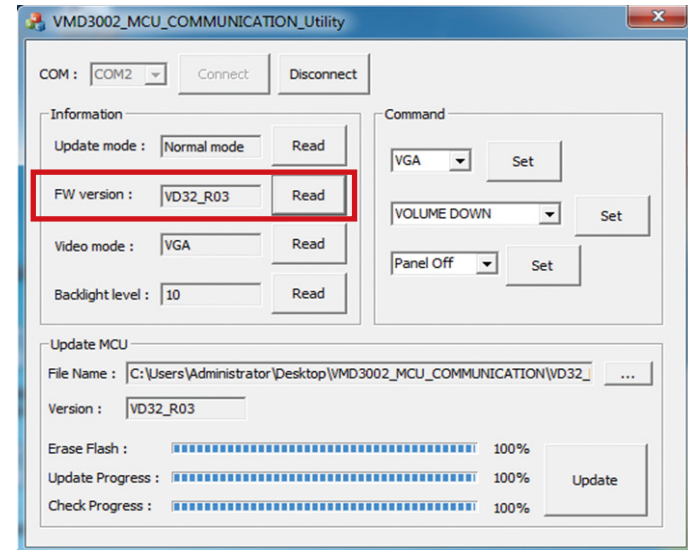

Chapter 6: Table for MCU Protocol

Frame-based Protocol

Start Code	0xF1
Command	1 Bytes
Data	N Byte, N = 0~19
End Code	0xF2

Command List

Name	Code
ReturnEraseFlash	0x11
ReturnWriteFlash	0x13
ReturnReadFlash	0x15
ReturnProgramState	0x21
ReturnFlashState	0x25
ReturnBSLInfo	0x31
ReturnReboot	0x37
ReturnUpdateMode	0x41
ReturnRequestUpdate	0x43
ReturnInvalidCommand	0x7F

Name	Code
EraseFlash	0x10
WriteFlash	0x12
ReadFlash	0x14
ReadProgramState	0x20
Flash Unlock	0x24
ReadBSLInfo	0x30
IsRequestReboot	0x36
ReadUpdateMode	0x40
IsRequestUpdate	0x42

Command 0x10: Erase Flash

Direction: Host -> MCU

Data Structure	Length	Comment
Start address	2	The start address will be erased
Length	2	The length will be erased

Command 0x11: ReturnEraseFlash

Direction: Host -> MCU

Data Structure	Length	Comment
EraseState	1	0x00: Erase Fail 0x01: Erase OK 0x02: Erase Address Out of Range 0x03: Flash is Locked

Command 0x15: Return Read Flash

Direction: MCU -> Host

The MCU sends this command in response to the command "Command 0x14: ReadFlash" sent by the Host.

Data Structure	Length	Comment
Start address	2	The start address will be read
Program data	N	The program data N

Command 0x20: Read Program State

Direction: Host -> MCU

The Command has no extra data.

Command 0x21: Return Program State

Direction: MCU -> Host

The MCU sends this command in response to the command "Command 0x21: ReturnProgramState" sent by the Soc.

Data Structure	Length	Comment
ProgramState	1	0x00: AP has not been updated yet. 0x01: AP has been updated. 0xFF: AP block data are mistake.

Command 0x24: Flash Unlock

Direction: Host -> MCU

Data Structure	Length	Comment
Password	7	Fixed Data as below: "Nexcom"

Command 0x25: Return Flash State

Direction: MCU -> Host

The MCU sends this command in response to the command "Command 0x24: FlashUnlock", "Command 0x10: EraseFlash", "Command 0x12: WriteFlash" or "Command 0x14: ReadFlash" sent by the Host.

Data Structure	Length	Comment
Flash State	1	0x00: Lock 0x01: Unlock

Command 0x30: Read BSL Info

Direction: Host -> MCU

The Command has no extra data.

Command 0x31: Return BSL Info

Direction: MCU -> Host

The MCU sends this command in response to the command "Command 0x30: ReadBSLInfo" sent by the Host.

Data Structure	Length	Comment
Product_Name	16	The Product Name will be read
MCU TYPE	16	The Device Family Type will be read
Flash Lock Password	8	The Flash Lock Password will be read
Boot Loader Version	8	The Boot loader version will be read
Application Version	8	The Application version will be read

Command 0x36: IsRequestReboot

Direction: Host -> MCU

The Command has no extra data.

Command 0x37: Return Reboot

Direction: MCU -> Host

The MCU sends this command in response to the command "Command 0x32: SendReboote" sent by the Host.

Data Structure	Length	Comment
State	1	0x01: Reboot (Wait for 3 sec) 0x00: Non

Command 0x40: ReadUpdateMode

Direction: Host -> MCU

The Command has no extra data.

Command 0x41: Return Update Mode

Direction: MCU -> Host

The MCU sends this command in response to the command "Command 0x41: ReadUpdateMode" sent by the Host.

Data Structure	Length	Comment
State	1	0x01: Update mode 0x00: Normal mode

Command 0x42: IsRequestUpdate

Direction: Host -> MCU

The Command has no extra data.

Command 0x43: Return Request Update

Direction: MCU -> Host

The MCU sends this command in response to the command "Command 0x42: IsRequestUpdate" sent by the Host.

Data Structure	Length	Comment
Data	4	Fixed Data as below: 0x55 0xCC 0x00 0xFF

Command 0x7F: Return Invalid Command

Direction: Host -> MCU

The Command has no extra data.