

---

# **ARES-530WT**

**Industrial Embedded Fanless Controller  
with Intel® Bay trail SoC**

## **User's Manual**

**Version 1.1**



---

This page is intentionally left blank.

---

---

## Revision History

Version	Date	Description
1.0	June, 2015	Initial release
1.1	Oct, 2018	Added "Pollution Degree" to <a href="#">1.3. Specifications</a> Revised terminal block information in <a href="#">1.4. Inside the Package</a>

<b>Revision History .....</b>	<b>i</b>
<b>Preface.....</b>	<b>v</b>
Copyright Notice .....	v
Declaration of Conformity .....	v
CE .....	v
FCC Class A.....	v
RoHS .....	vi
SVHC / REACH .....	vi
Important Safety Instructions .....	vii
Warning .....	viii
Replacing Lithium Battery.....	viii
Technical Support .....	viii
Warranty .....	ix
<b>Chapter 1 - Introduction.....</b>	<b>1</b>
1.1. Product Highlights .....	2
1.2. About this Manual .....	2
1.3. Specifications .....	2
1.4. Inside the Package .....	4
1.5. Ordering Information.....	4
1.5.1. Configure-to-Order Service.....	5
<b>Chapter 2 - Getting Started.....</b>	<b>7</b>
2.1. Dimensions .....	8
2.1. Dimensions .....	8
2.2. Take A Tour .....	9
2.3. Driver Installation Notes .....	11
<b>Chapter 3 - System Configuration .....</b>	<b>13</b>
3.1. Board Layout .....	14
3.1.1. Main Board.....	14
3.1.2. Power Board .....	16
3.2. Jumper & Connectors .....	18
3.2.1. Main Board Jumpers and Connectors .....	18
3.2.3. Daughter Board Jumpers & Connectors .....	24
<b>Chapter 4 - Installation and Maintenance.....</b>	<b>39</b>
4.1. Install Hardware.....	40
4.1.1. Open the Computer .....	40
4.1.2. Restore the upper cover .....	42
4.1.3. Install Memory Module.....	43
4.2. DIN-rail Mount.....	45
4.2.1. Mount the Computer .....	45
4.2.2. Dismount the Computer.....	47



4.3. Ground the Computer.....	48
4.4. Wire DC-in Power Source.....	49
<b>Chapter 5 - BIOS .....</b>	<b>51</b>
5.1. Main.....	54
5.2. Advanced.....	55
5.2.1. Boot Configuration .....	56
5.2.2. PCI Express Configuration.....	56
5.2.3. USB Configuration .....	57
5.2.4. SATA Configuration .....	58
5.2.5. Console redirection.....	59
5.2.6. SIO FINTEK71869E.....	61
5.3. Security.....	62
5.4. Power.....	63
5.5. Boot.....	64
5.6. Exit.....	66
<b>Appendices .....</b>	<b>67</b>
Appendix A: Install mSATA Storage.....	68
Appendix B: Wi-Fi Module WIFI-AT2300 Hardware Installation .....	70
B.1. Install WIFI-AT2300 .....	70

---

This page is intentionally left blank.

## Copyright Notice

All Rights Reserved.

The information in this document is subject to change without prior notice in order to improve the reliability, design and function. It does not represent a commitment on the part of the manufacturer.

Under no circumstances will the manufacturer be liable for any direct, indirect, special, incidental, or consequential damages arising from the use or inability to use the product or documentation, even if advised of the possibility of such damages.

This document contains proprietary information protected by copyright. All rights are reserved. No part of this document may be reproduced by any mechanical, electronic, or other means in any form without prior written permission of the manufacturer.

## Declaration of Conformity

### CE

The CE symbol on the computer indicates that it is in compliance with the directives of the Union European (EU). A Certificate of Compliance is available by contacting Technical Support.

This product has passed the CE test for environmental specifications when shielded cables are used for external wiring. We recommend the use of shielded cables. This kind of cable is available from ARBOR. Please contact your local supplier for ordering information.

### Warning

This is a class A product. In a domestic environment this product may cause radio interference in which case the user may be required to take adequate measures.

## FCC Class A

This device complies with Part 15 of the FCC Rules. Operation is subject to the following two conditions:

- (1) This device may not cause harmful interference, and
- (2) This device must accept any interference received, including interference that may cause undesired operation.

## Preface

---

### NOTE:

This equipment has been tested and found to comply with the limits for a Class A digital device, pursuant to Part 15 of the FCC Rules. These limits are designed to provide reasonable protection against harmful interference when the equipment is operated in a commercial environment. This equipment generates, uses, and can radiate radio frequency energy and, if not installed and used in accordance with the instruction manual, may cause harmful interference to radio communications. Operation of this equipment in a residential area is likely to cause harmful interference in which case the user will be required to correct the interference at his own expense.

### RoHS

ARBOR Technology Corp. certifies that all components in its products are in compliance and conform to the European Union's Restriction of Use of Hazardous Substances in Electrical and Electronic Equipment (RoHS) Directive 2002/95/EC.

The above mentioned directive was published on 2/13/2003. The main purpose of the directive is to prohibit the use of lead, mercury, cadmium, hexavalent chromium, polybrominated biphenyls (PBB), and polybrominated diphenyl ethers (PBDE) in electrical and electronic products. Member states of the EU are to enforce by 7/1/2006.

ARBOR Technology Corp. hereby states that the listed products do not contain unintentional additions of lead, mercury, hex chrome, PBB or PBDB that exceed a maximum concentration value of 0.1% by weight or for cadmium exceed 0.01% by weight, per homogenous material. Homogenous material is defined as a substance or mixture of substances with uniform composition (such as solders, resins, plating, etc.). Lead-free solder is used for all terminations (Sn(96-96.5%), Ag(3.0-3.5%) and Cu(0.5%)).

### SVHC / REACH

To minimize the environmental impact and take more responsibility to the earth we live, Arbor hereby confirms all products comply with the restriction of SVHC (Substances of Very High Concern) in (EC) 1907/2006 (REACH --Registration, Evaluation, Authorization, and Restriction of Chemicals) regulated by the European Union.

All substances listed in SVHC < 0.1 % by weight (1000 ppm)

## Important Safety Instructions

Read these safety instructions carefully

1. Read all cautions and warnings on the equipment.
2. Place this equipment on a reliable surface when installing. Dropping it or letting it fall may cause damage
3. Make sure the correct voltage is connected to the equipment.
4. For pluggable equipment, the socket outlet should be near the equipment and should be easily accessible.
5. Keep this equipment away from humidity.
6. The openings on the enclosure are for air convection and protect the equipment from overheating. **DO NOT COVER THE OPENINGS.**
7. Position the power cord so that people cannot step on it. Do not place anything over the power cord.
8. Never pour any liquid into opening. This may cause fire or electrical shock.
9. Never open the equipment. For safety reasons, the equipment should be opened only by qualified service personnel.
10. If one of the following situations arises, get the equipment checked by service personnel:
  - a. The power cord or plug is damaged.
  - b. Liquid has penetrated into the equipment.
  - c. The equipment has been exposed to moisture.
  - d. The equipment does not work well, or you cannot get it to work according to the user's manual.
  - e. The equipment has been dropped or damaged.
  - f. The equipment has obvious signs of breakage.
11. Keep this User's Manual for later reference.

### Product Heat



The computer generates heat during operation. Contact the computer's chassis with your body could cause discomfort or even a skin burn.

### **Warning**

The Box PC and its components contain very delicately Integrated Circuits (IC). To protect the Box PC and its components against damage caused by static electricity, you should always follow the precautions below when handling it:

1. Disconnect your Box PC from the power source when you want to work on the inside.
2. Use a grounded wrist strap when handling computer components.
3. Place components on a grounded antistatic pad or on the bag that came with the Box PC, whenever components are separated from the system.

### **Replacing Lithium Battery**

Incorrect replacement of the lithium battery may lead to a risk of explosion.

The lithium battery must be replaced with an identical battery or a battery type recommended by the manufacturer.

Do not throw lithium batteries into the trash can. It must be disposed of in accordance with local regulations concerning special waste.

### **Technical Support**

If you have any technical difficulties, please consult the user's manual first at:

<http://www.arbor.com.tw>

Please do not hesitate to call or e-mail our customer service when you still cannot find out the answer.

<http://www.arbor.com.tw>

E-mail: [info@arbor.com.tw](mailto:info@arbor.com.tw)

## **Warranty**

This product is warranted to be in good working order for a period of one year from the date of purchase. Should this product fail to be in good working order at any time during this period, we will, at our option, replace or repair it at no additional charge except as set forth in the following terms. This warranty does not apply to products damaged by misuse, modifications, accident or disaster.

Vendor assumes no liability for any damages, lost profits, lost savings or any other incidental or consequential damage resulting from the use, misuse of, or inability to use this product. Vendor will not be liable for any claim made by any other related party.

Vendors disclaim all other warranties, either expressed or implied, including but not limited to implied warranties of merchantability and fitness for a particular purpose, with respect to the hardware, the accompanying product's manual(s) and written materials, and any accompanying hardware. This limited warranty gives you specific legal rights.

Return authorization must be obtained from the vendor before returned merchandise will be accepted. Authorization can be obtained by calling or faxing the vendor and requesting a Return Merchandise Authorization (RMA) number. Returned goods should always be accompanied by a clear problem description.

---

This page is intentionally left blank.



---

# Chapter 1

## Introduction

### 1.1. Product Highlights

- **Fanless, Cable-less and Modularized Design**
- **Wide Range DC Power Input (9 ~ 36V)**
- **Easy Installation/Maintenance**

### 1.2. About this Manual

This manual is meant for the experienced users and integrators with hardware knowledge of personal computers. If you are not sure about the description herein, consult your vendor before further handling.

We recommend that you keep one copy of this manual for the quick reference for any necessary maintenance in the future. Thank you for choosing ARBOR products.

### 1.3. Specifications

System Kernel	
<b>Processor/ Chipset</b>	Soldered onboard Intel® Celeron® J1900 2.0GHz processor
<b>BIOS</b>	Insyde BIOS
<b>Graphics</b>	Integrated Intel® HD Graphic
<b>System Memory</b>	1 x 204-pin DDR3L SO-DIMM socket, supporting 1333MHz SDRAM up to 8GB
<b>Ethernet Controller</b>	2 x Intel® i210IT GbE controllers
I/O Ports	
<b>Serial Port</b>	1 x DB9 male connectors for RS-232/422 1 x DB9 male connectors for RS-422/485
<b>USB Port</b>	5 x USB 2.0 ports 1 x USB 3.0 port 1 x USB type A connector (Internal)
<b>LAN Port</b>	2 x RJ-45 Gigabit Ethernet ports
<b>Video Port</b>	1 x VGA connector 1 x DVI-D connector
<b>Expansion Bus</b>	1 x Half size Mini-Card socket 2 x mSATA socket for SSD

<b>Storage</b>	
<b>Type</b>	2 x mSATA socket
<b>Qualification</b>	
<b>Certification</b>	CE, FCC Class A
<b>Environment</b>	
<b>Operating Temp.</b>	ARES-530WT-J1900: -40 ~ 70°C (-40 ~ 158°F), ambient with air flow ARES-530WT-E3845 -40 ~ 85°C (-40 ~ 185°F), ambient with air flow
<b>Storage Temp.</b>	-40 ~ 85°C (-40 ~ 185°F)
<b>Relative Humidity</b>	10 ~ 95% @ 70°C (non-condensing)
<b>Pollution Degree</b>	Degree 2
<b>Vibration</b>	5~500Hz 3G rms X,Y,Z axis w/SSD, according to IEC 68-2-64
<b>Shock</b>	40G peak acceleration (11 m sec. duration), operation 60G peak acceleration (11 m sec. duration), non operation According to IEC 68-2-27
<b>Mechanical</b>	
<b>Construction</b>	Aluminum chassis
<b>Mounting</b>	DIN Rail quick release mounting kit
<b>Weight (Net / Gross)</b>	1.5kg (3.30 lb) (Barebone)
<b>Dimensions (W x D x H)</b>	70 x 125 x 160 mm
<b>Power Requirement</b>	
<b>Power Input</b>	DC 9-36V (w/ 3-pin DC input terminal block)
<b>Power Consumption</b>	13W (w/mSATA)

### 1.4. Inside the Package

Upon opening the package, carefully inspect the contents. If any of the items is missing or appears damaged, contact your local dealer or distributor. The package should contain the following items:

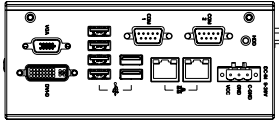

1 x ARES-530WT Programmable Embedded Controller









1 x Driver CD  
1 x User's Manual  
1 x 1x3 terminal block for power

### 1.5. Ordering Information

<b>ARES-530WT-J1900</b>	Barebone system w/ Intel® Celeron J1900 processor and 2GB SO-DIMM RAM module
-------------------------	--

### 1.5.1. Configure-to-Order Service

Make the computer more tailored to your needs by selecting one or more components from the list below to be fabricated to the computer.

<b>WIFI-AT2300</b>	Atheros AR9462 Wi-Fi module w/ 20cm internal wiring	
<b>ANT-H11</b>	1 x 2dBi HSUPA antenna	
<b>ANT-D11</b>	1 x Wi-Fi Dual-band 2.4G/5G antenna	
<b>MM-3L-4G</b>	DDR3L-1333 4GB SDRAM	
<b>MM-3L-8G</b>	DDR3L-1333 8GB SDRAM	
<b>16GB SSD</b>	mSATA MLC 16GB	
<b>32GB SSD</b>	mSATA MLC 32GB	

---

This page is intentionally left blank.

---

# Chapter 2

## Getting Started

## 2.1. Dimensions

The following illustration shows the dimensions of ARES-530WT, with the measurements in width, depth, and height called out.

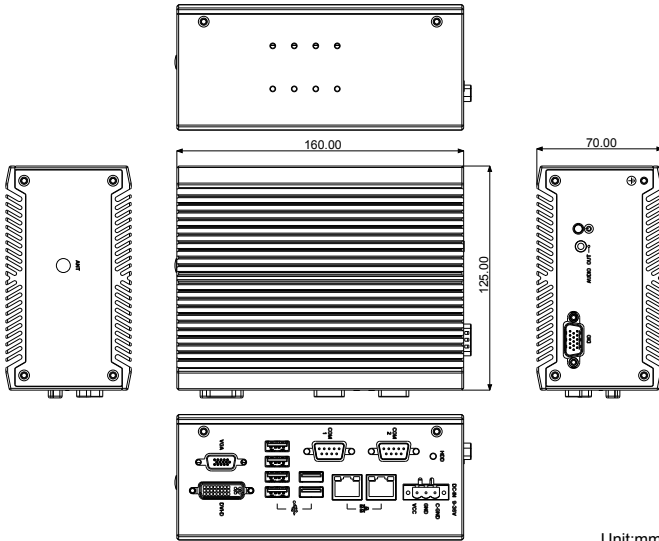

Unit:mm

Unit: mm



## 2.2. Take A Tour

The computer has some I/O ports, status LED light and controls on the front and rear panels. The following illustrations show all the components called out for ARES-530WT.

### Front View

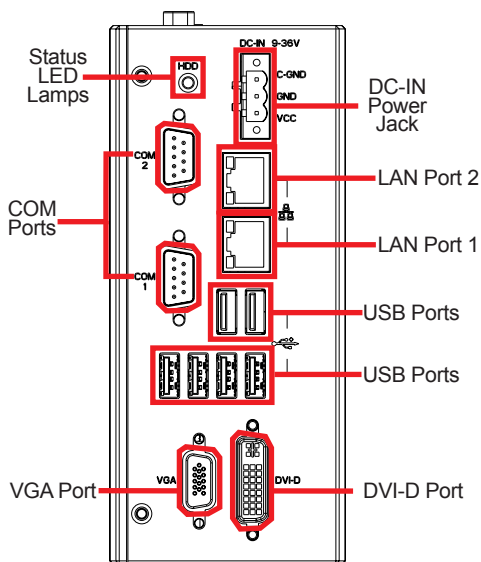

- ### Status LED Lamps

LED lamps are recessed on the front side of the computer to draw users' prompt awareness of the computer's contiguous events such as power on/off, data transmission and so on.

The lamp and the notification delivered is summarized as following:

LED Lamp	Color	State	Description
Storage	Red	Flashing	Storage is operating

# Getting Started

---

## Side View

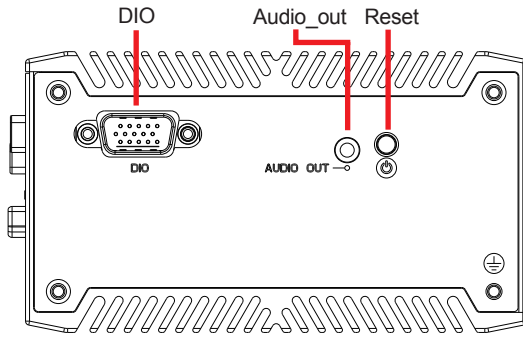

## Rear View

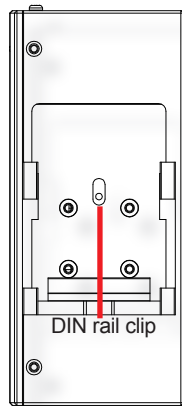

---

## 2.3. Driver Installation Notes

The ARES-530WT supports the operating systems of Windows 8.1 and Windows 7. For these operating systems, find the necessary device drivers on the CD that comes with your purchase. For different operating systems, the installation of drivers/utilities may vary slightly, but generally they are similar. **DO** follow the sequence below to install the drivers to prevent errors:

**Chipset**→**Graphics**→**Audio**→**Ethernet**

Paths to find various drivers on the CD:

### Windows 7

Device	Driver Path
Audio	\Audio\32 bit
	\Audio\64 bit
Chipset	\Chipset\ARES-530WT\32bit\Intel Chipset Software_Win7_8_8.1_32bit_64bit_R10.0.14
	\Chipset\ARES-530WT\64bit\Intel Chipset Software_Win7_8_8.1_32bit_64bit_R10.0.14
Ethernet	\Ethernet\Intel\32bit\LAN 18.8.1_32
	\Ethernet\Intel\64bit\LAN 18.8.1_64
Graphic	\Graphic\win 7\Kit 101116 20140402 32bit\Intel_EMGD.WIN7_PC_Version_36_15_0_1073
	\Graphic\win 7\KIT 101117 20140402 64bit\Intel_EMGD.WIN7_PC_Version_37_15_0_1073
GPIO	\GPIO\windows 7 32_64\Intel Atom E3800 Win7 IO Drivers_Gold_v1.0 package 501232_20140211
I2C	\I2C\windows 7 32_64\Intel Atom E3800 Win7 IO Drivers_Gold_v1.0 package 501232_20140211

---

## Getting Started

---

### Windows 8

Device	Driver Path
Audio	\Audio\32 bit
	\Audio\64 bit
Chipset	\Chipset\ARES-530WT\32bit\Intel Chipset Software_Win7_8_8.1_32bit_64bit_R10.0.14
	\Chipset\ARES-530WT\64bit\Intel Chipset Software_Win7_8_8.1_32bit_64bit_R10.0.14
Ethernet	\Ethernet\Intel\32bit\LAN 18.8.1_32
	\Ethernet\Intel\64bit\LAN 18.8.1_64
Graphic	\Graphic\Win8\32bit\Kit 57832_win8_32bit_2013-1202\Win32
	\Graphic\Win8\64bit\Kit 5783364_win8_8.1_64_2013-1202\win64
MBI	\MBI\MBI Kit 58443 20140106_windows 8_8.132_64
TXE	\TXE\TXE Kit 100885

### Windows 8.1

Device	Driver Path
Audio	\Audio\32 bit
	\Audio\64 bit
Chipset	\Chipset\ARES-530WT\32bit\Intel Chipset Software_Win7_8_8.1_32bit_64bit_R10.0.14
	\Chipset\ARES-530WT\64bit\Intel Chipset Software_Win7_8_8.1_32bit_64bit_R10.0.14
Ethernet	\Ethernet\Intel\32bit\LAN 18.8.1_32
	\Ethernet\Intel\64bit\LAN 18.8.1_64
GPIO	\GPIO\Kit 100882 20140211 windows 8.1 64\GPIO
I2C	\I2C\Kit 100882 20140211 windows 8.1 64\I2C
Graphic	\Graphic\Win8.1\32bit\Kit 57832_win8_32bit_2013-1202\Win32
	\Graphic\Win8.1\64bit\Kit 5783364_win8_8.1_64_2013-1202\win64
MBI	\MBI\MBI Kit 58443 20140106_windows 8_8.132_64
TXE	\TXE\TXE Kit 100885

---

---

# Chapter 3

## System Configuration

## 3.1. Board Layout

The engine of the computer is comprised of a main board and a daughter board. This section will provide an thorough view of these boards.

### 3.1.1. Main Board

#### Board Top

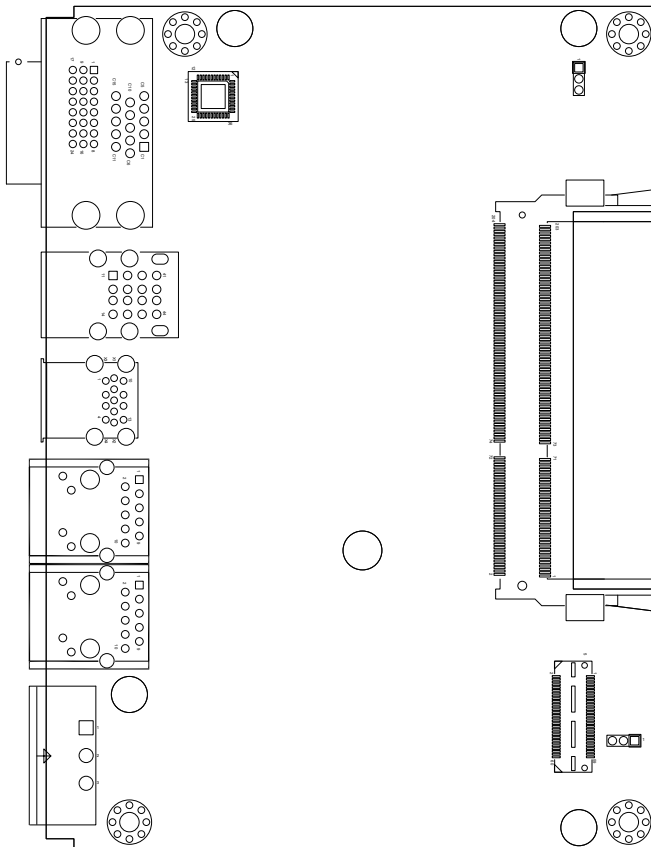

Board Bottom

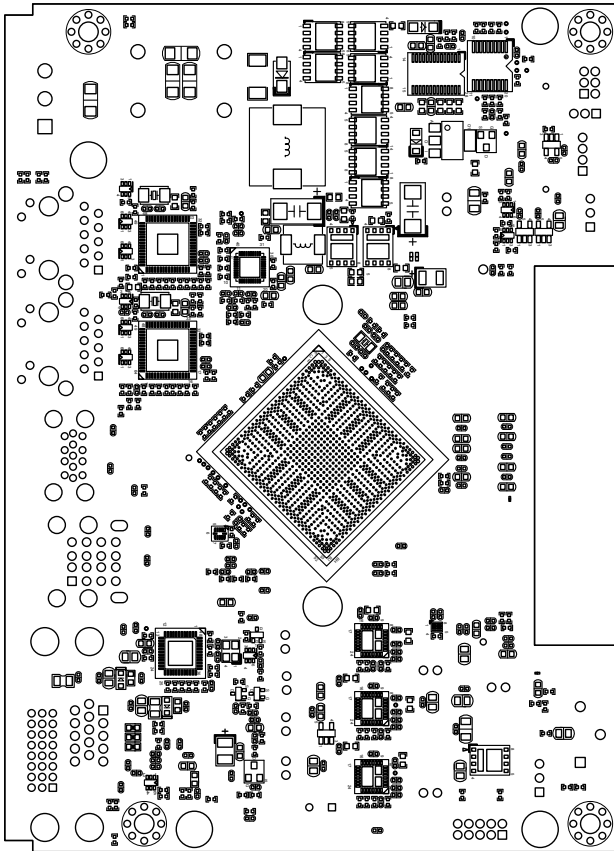

### 3.1.2. Power Board

#### Board Top

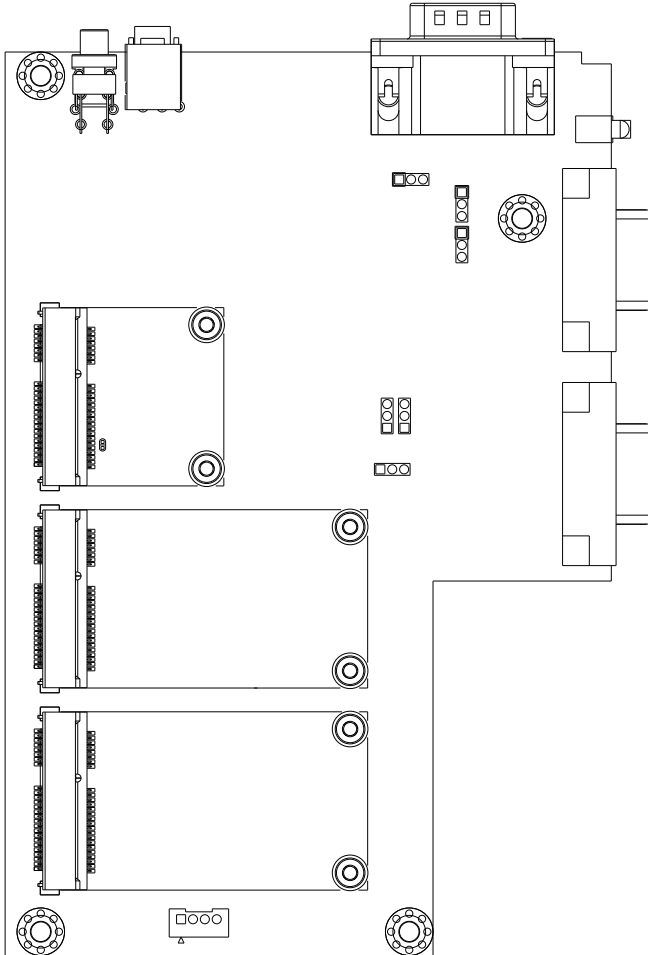



Board Bottom

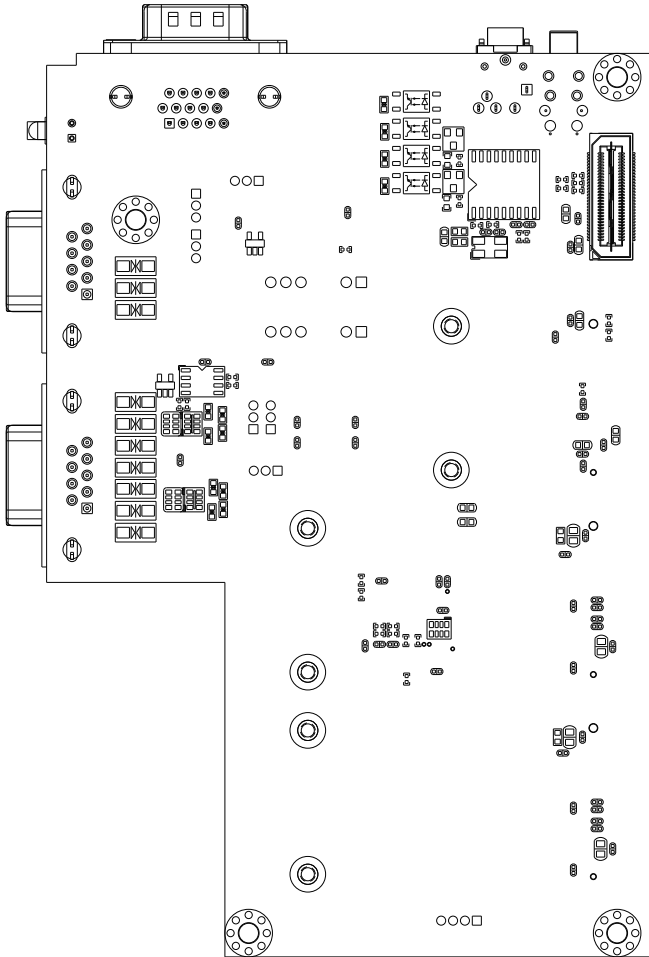

## 3.2. Jumper & Connectors

The main board comes with some connectors to join some devices and some jumpers to alter hardware configuration. The power board also comes with some connectors. The following in this chapter will explicate each of these components.

### 3.2.1. Main Board Jumpers and Connectors

This section will guide you through the Jumpers and connectors on the main board.

#### JBAT1

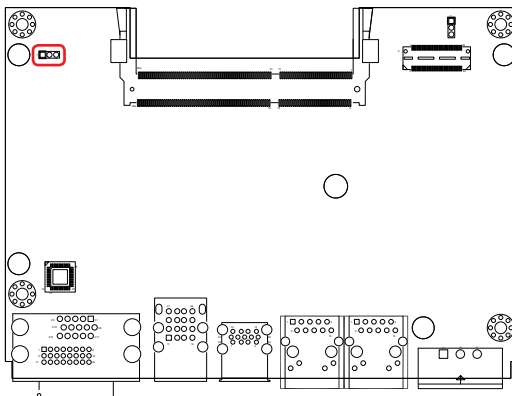

**Function:** Clears/keeps CMOS  
**Jumper Type:** 2.54 mm pitch 1x3-pin header  
**Setting:**

Pin	Description
1-2	Keeps CMOS (default)
2-3	Clears CMOS



**JATX1**

**Function:** ATX/AT Mode selection  
**Jumper Type:** 2.0mm pitch 1x3 pin header  
**Setting:**

Pin	Description
1-2 AT mode	
2-3 ATX mode (default)	

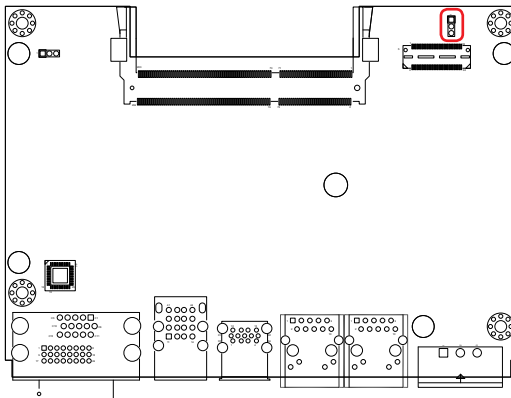

# System Configuration

## CN1

**Function:** External VGA port for CRT display

**Connector Type:** D-sub 15-pin female connector

Pin	Description	Pin	Description
1	CRT_R	2	CRT_G
3	CRT_B	4	N/C
5	GND	6	GND
7	GND	8	GND
9	VCC5	10	N/C
11	N/C	12	DCC_DATA
13	HSYNC	14	VSYNC
15	DDC_CLK		

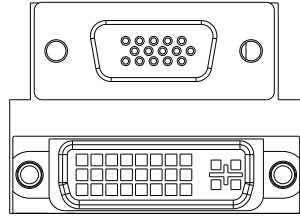

## Front Panel

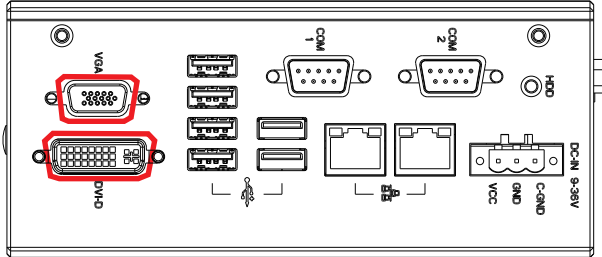

**CN2**

**Function:** SUMIT Connector for daughter board  
**Connector Type:** SUMIT Connector

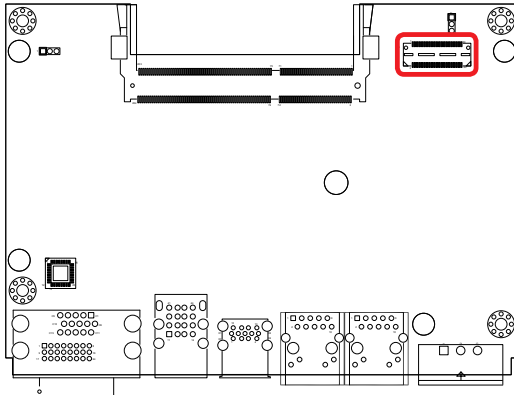

**CN3**

**Function:** USB3.0/2.0 ports  
**Connector Type:** USB double stack port

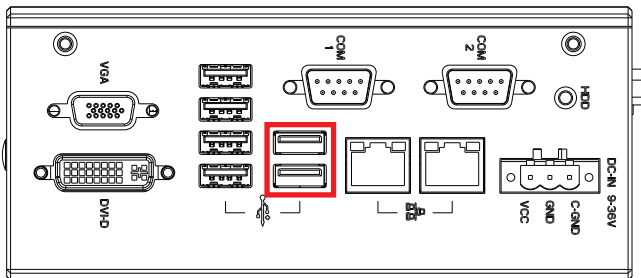

# System Configuration

## CN4

**Function:** USB2.0 ports  
**Connector Type:** USB stack port

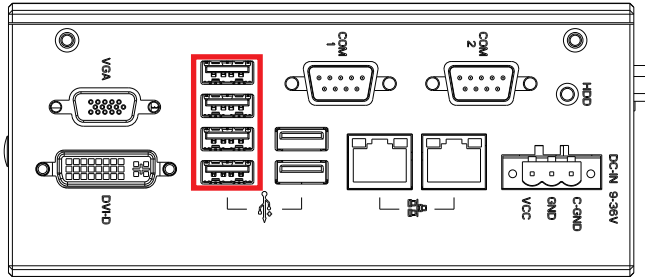

## CN5&CN6

**Function:** RJ-45 LAN ports  
**Connector Type:** RJ-45 LAN port with LED lamps

### Pin Assignment:

LAN (RJ-45)	
LED	Definition
Speed	Amber: 1000M
	Green: 10/100M
Link/Act	On: Linked
	Blink: Network Activity
	Off: No Link

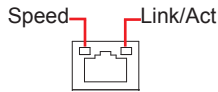

## Front Panel

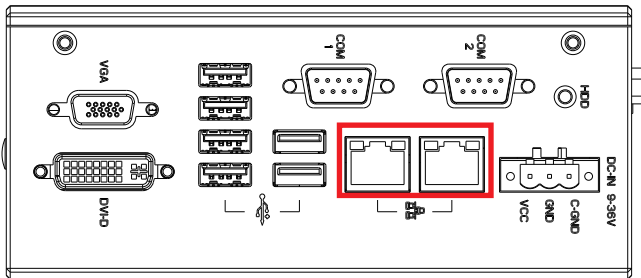

**PWRIN1**

**Function:** DC-IN power port

**Connector Type:** 3-pin terminal block

Pin	Description
1	VCC +9~36V
2	GND
3	C-GND

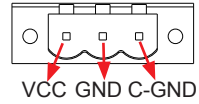

**Board Top**

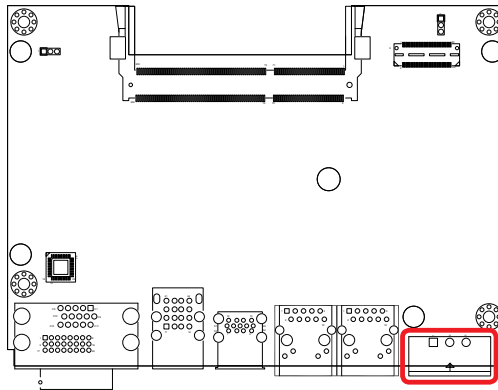

**Side Panel**

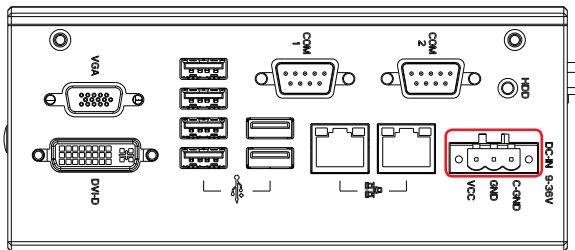

### 3.2.3. Daughter Board Jumpers & Connectors



This section will guide you through the jumpers and connectors on the daughter board.

#### JP1

**Function:** COM1 RS422 Terminator Selector

**Jumper Type:** 2.00 mm pitch 1x3-pin header

**Setting:**

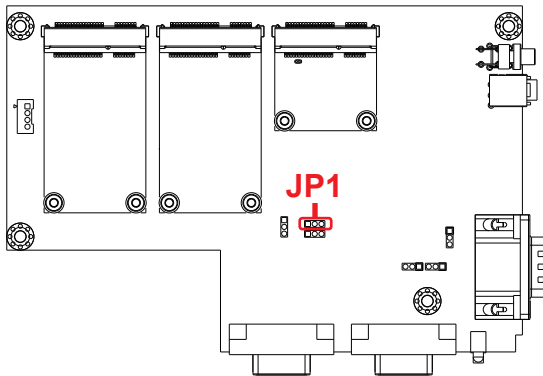

Pin	Description	
1-2	Normal Mode (Default)	
2-3	120 ohm Terminal Mode	





**JP2**

**Function:** COM1 RS422 Terminator Selector  
**Jumper Type:** 2.00 mm pitch 1x3-pin header  
**Setting:**

Pin	Description	
1-2	Normal Mode(Default)	
2-3	120 ohm Terminal Mode	

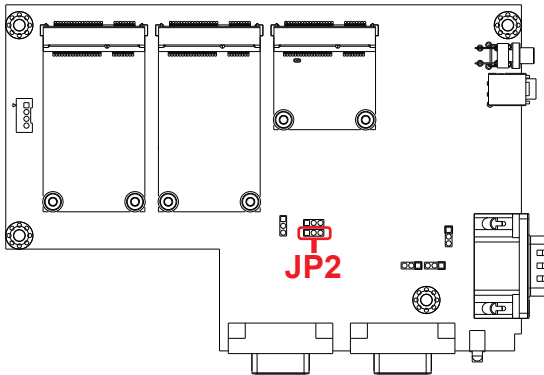



# System Configuration

---

## JP3

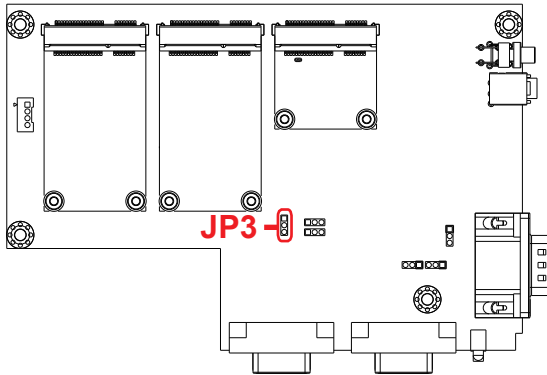

**Function:** COM1 RS232/422 Selector  
**Jumper Type:** 2.00 mm pitch 1x3-pin header  
**Setting:**

Pin	Description
1-2	RS232 
2-3	RS422(Default) 



**JP11**

**Function:** COM2 RS485(422) Terminator Selector  
**Jumper Type:** 2.00 mm pitch 1x3-pin header  
**Setting:**

Pin	Description	
1-2	Normal Mode (Default)	
2-3	120 ohm Terminal Mode	

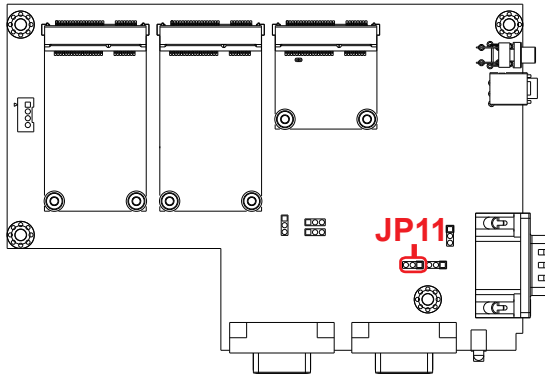



# System Configuration

---

## JP12

**Function:** COM2 422 Terminator Selector  
**Jumper Type:** 2.00 mm pitch 1x3-pin header  
**Setting:**

Pin	Description
1-2	Normal Mode (Default) 
2-3	120 ohm Terminal Mode 

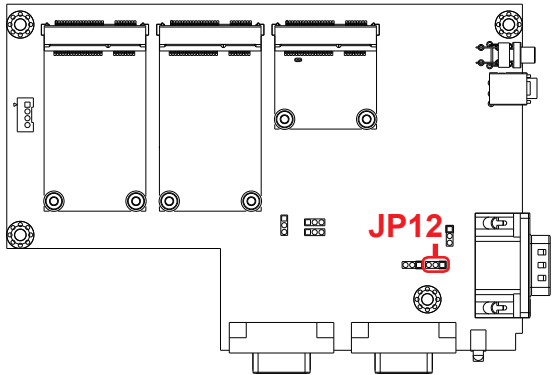

**JP5**

**Function:** COM2 RS485/422 Selector  
**Jumper Type:** 2.00 mm pitch 1x3-pin header  
**Setting:**

Pin	Description
1-2	RS422 (Default)
2-3	RS485

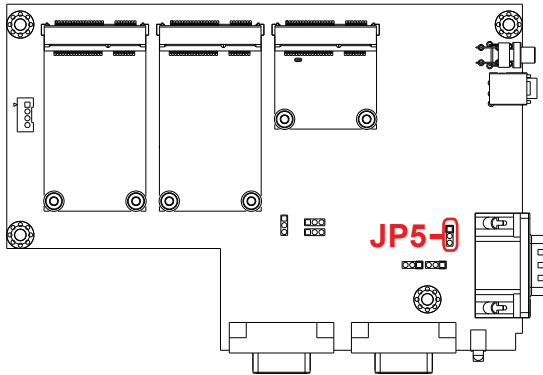

# System Configuration

## CN2

**Description:** PCI Express Mini-card socket  
**Connector Type:** Onboard 0.8mm-pitch 52-pin edge card connector

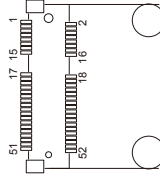

Pin	Desc.	Pin	Desc.	Pin	Desc.	Pin	Desc.
1	WAKE#	16	N/C	31	PE_CAD3_TX-	42	N/C
2	+3.3V	17	N/C	32	SMB_DATA	43	GND
3	N/C	18	GND	33	PE_CAD3_TX+	44	N/C
4	GND	19	N/C	34	GND	45	N/C
5	N/C	20	W_DISABLE#	35	GND	46	N/C
6	+1.5V	21	GND	36	N/C	47	N/C
7	CLKREQ#	22	PCIE_ARST#	37	GND	48	+1.5V
8	N/C	23	PE_CAD3_RX-	38	N/C	49	N/C
9	GND	24	+3.3V	39	+3.3V	50	N/C
10	UIM_DATA_A	25	PE_CAD3_RX+	40	GND	51	N/C
11	REFCLK-	26	GND	41	+3.3V	52	+3.3V
12	N/C	27	GND				
13	REFCLK+	28	+1.5V				
14	N/C	29	GND				
15	GND	30	SMB_CLK				

## Board Top

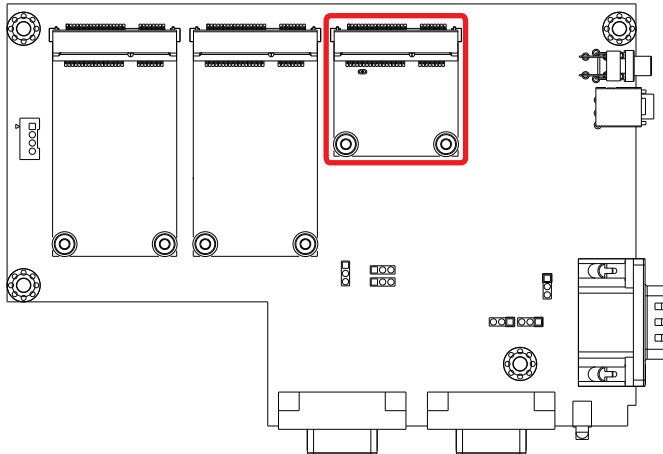

**CN3&4**

**Description:** mSATA socket  
**Connector Type:** Onboard 0.8mm pitch 52-pin edge card connector

Pin	Desc.	Pin	Desc.	Pin	Desc.
1	NC	20	NC	36	NC
2	+3.3V	21	GND	37	GND
3	NC	22	NC	38	NC
4	GND	23	TX+	39	+3.3V
5	NC	24	+3.3V	40	GND
6	NC	25	TX-	41	+3.3V
7	NC	26	GND	42	NC
8	NC	27	GND	43	GND
9	GND	28	NC	44	NC
10	NC	29	GND	45	NC
11	NC	30	NC	46	NC
12	NC	31	RX-	47	NC
13	NC	32	NC	48	NC
14	NC	33	RX+	49	NC
15	GND	34	GND	50	GND
16	NC	35	GND	51	NC
17	NC			52	+3.3V
18	GND				
19	NC				

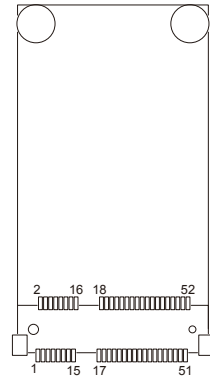

**Main Board Top**

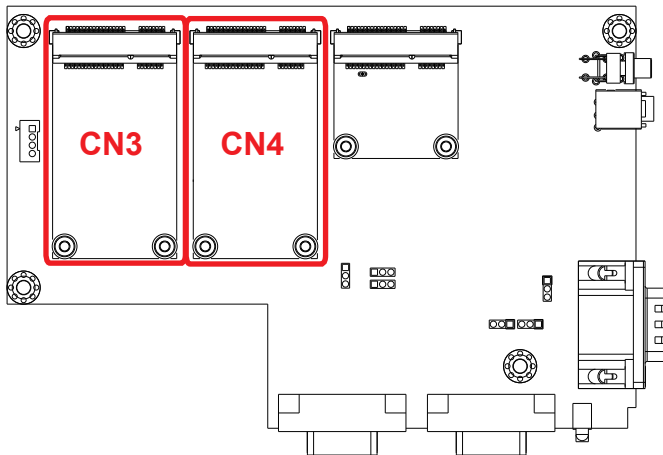

# System Configuration

## CN5

**Function:** COM1 RS-232/422 Port

**Connector Type:** External 9-pin D-sub male connector

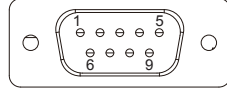

Pin	Description	Pin	Description
1	DCD/(422TX-)	6	DSR
2	RXD/(422TX+)	7	RTS
3	TXD(422RX+)	8	CTS
4	DTR(422RX-)	9	RI
5	GND		

## Board Top

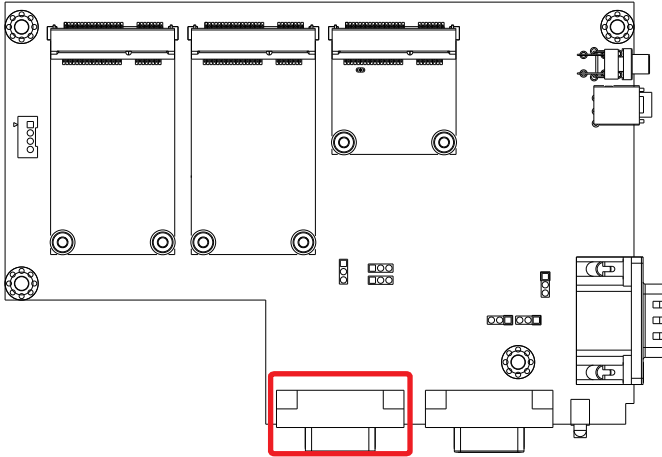



**CN6**

**Function:** COM2 RS485/RS422 Port

**Connector Type:** External 9-pin D-sub male connector

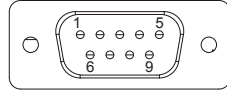

Pin	Description	Pin	Description
1	485-(422TX-)	6	
2	485+(422TX+)	7	
3	(422RX+)	8	
4	(422RX-)	9	
5			

**Board Top**

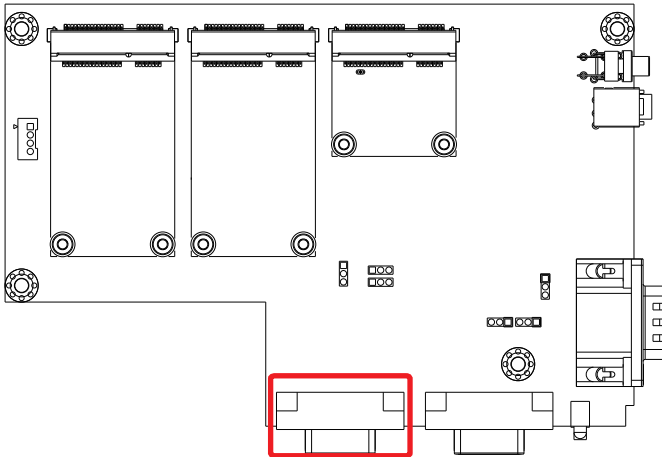

## System Configuration

---

### CN7

**Function:** Daughter board Connector  
**Connector Type:** SUMIT Connector

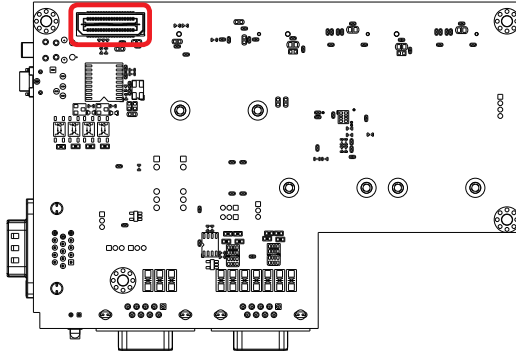

### JSW1

**Function:** The reset button

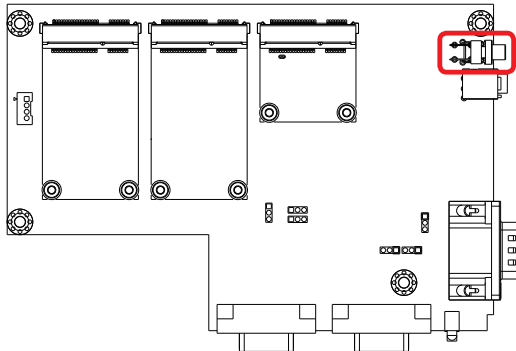

JDIO1

**Description:** DIGITAL SINGAL INPUT AND OUTPUT

**Connector Type:** DSUB-15 Male Connector

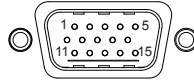

Pin	Description	Pin	Description	Pin	Description
1	PDI1	6	PDO1	11	NC
2	PDI2	7	PDO2	12	NC
3	PDI3	8	PDO3	13	NC
4	PDI4	9	PDO4	14	GND
5	ISO_GND	10	ISO_GND	15	GND

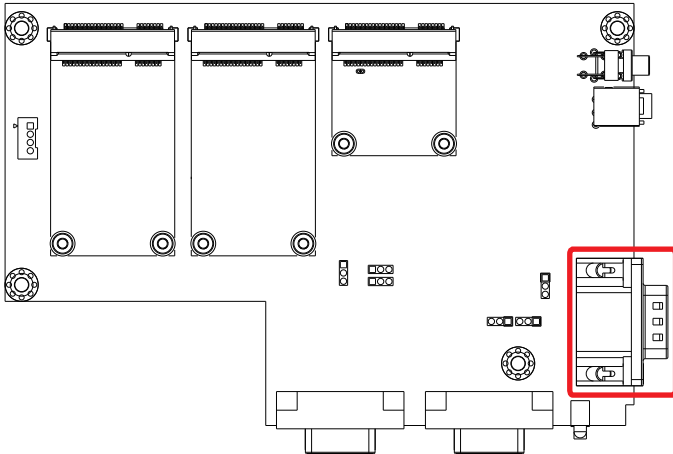

## System Configuration

---

### J13

**Function:** Audio Out

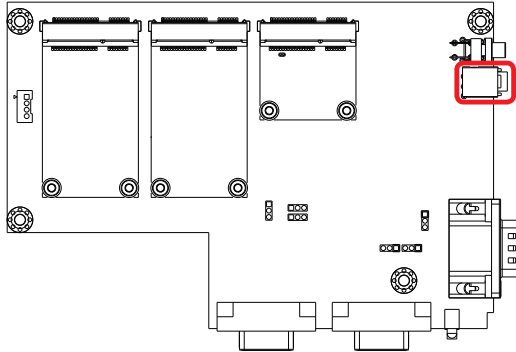





---

# Chapter 4

## Installation and Maintenance

### 4.1. Install Hardware

The ARES-530WT is constructed based on modular design to make it easy for users to add hardware or to maintain the computer. The following sections will guide you to the simple hardware installations for the computer.

#### 4.1.1. Open the Computer

Most of the connectors are built on the top side of the main board. To access these components, the computer's top cover has to go. Follow through the steps below to remove the top cover from the computer.

1. Place the computer on a flat surface. Loosen and remove the 12 screws from the computer's four edges as shown in the illustration below:

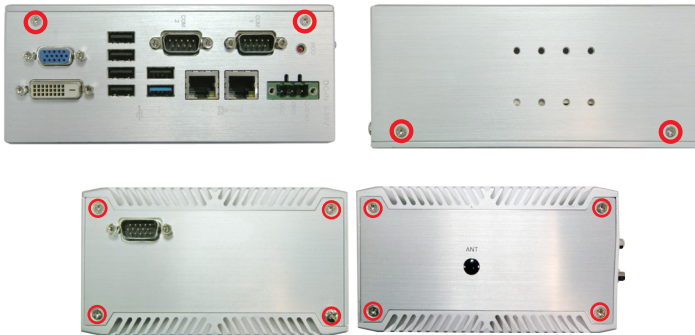

2. Remove the 2 side covers completely from the computer.





3. Remove the upper cover completely from the computer.



4. The inside of the computer comes to view.

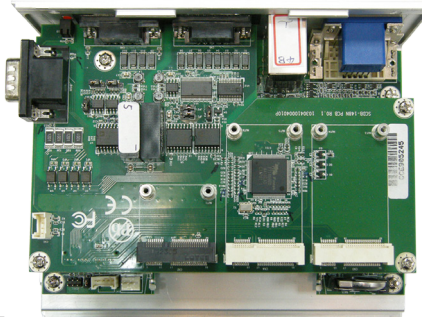

## Installation & Maintenance

---

### 4.1.2. Restore the upper cover

1. Combine the upper cover with the bottom cover.



2. Restore the side covers and fasten the screws.

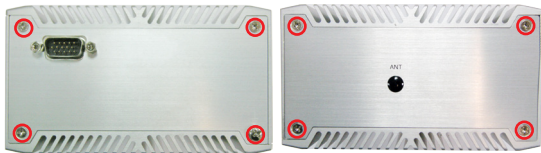

3. Fasten the screws on the front and back sides to complete the assembly.

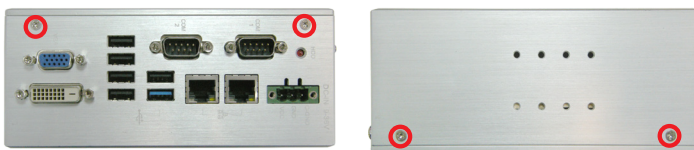

### 4.1.3. Install Memory Module

The main board has one dual inline memory module (DIMM) socket. Load the computer with a memory module to make the computer run programs. The memory module for the computer's SO-DIMM socket should be a 204-pin DDR3 with a "key notch" off the centre among the pins, which enables the memory module for particular applications. There are another two notches at each left and right side of the memory module to help fix the module in the socket.

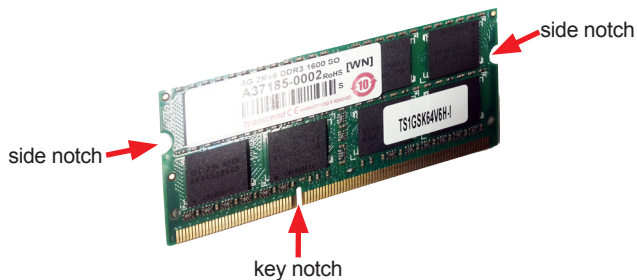

#### To install a DDR3 memory module:

1. Remove the bottom cover from the computer as described in on page.  
The inside of the computer comes to view.
2. Find the SO-DIMM socket on the board as marked in the illustration below.

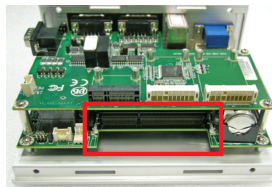

The SO-DIMM socket is horizontal type, and it has two spring-loaded locks to fix the memory module.

## Installation & Maintenance

---

3. By a slanted angle, fully plug the memory module until it cannot be plugged any more.

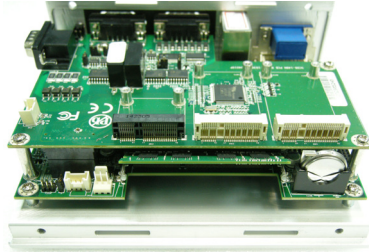

4. Press down the memory module until it is auto-locked in place.

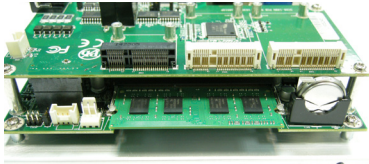

## 4.2. DIN-rail Mount

Integrate the computer to where it works by mounting it to a DIN-rail in the surroundings. Such integration relies on the DIN-rail clip on the rear side of the computer. Follow through the guide below to mount/dismount the computer to/from a DIN-rail.

### 4.2.1. Mount the Computer

1. Find the DIN-rail clip on the rear side of the computer as illustrated below:

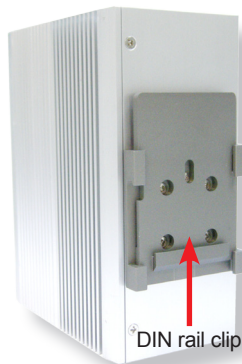

2. Hold the computer in a portrait orientation.

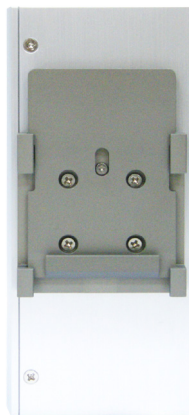

## Installation & Maintenance

---

3. To mount the unit on a DIN rail, slot the bottom part of the Din-rail clip into the bottom guide of the rail and lift the computer until the top side of the Din-rail hook clicks into place.

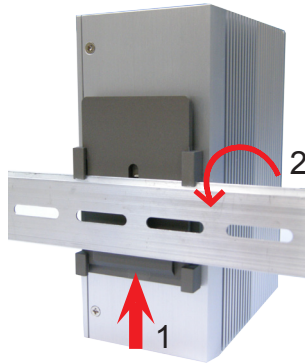

If the computer cannot be successfully fixed onto the DIN-rail, reverse the computer and clip the computer onto the DIN-rail by the bottom side.



Computer mounted on DIN-rail

#### 4.2.2. Dismount the Computer

Power off the computer and disconnect all cables before proceeding to dismount the computer off the DIN-rail.

1. Push the bottom side of the computer up, with both hands to release the top part of clip from the DIN-rail.
2. Once the clip is released from the DIN-rail, completely dismount the computer off the DIN-rail by pulling the computer's top side.

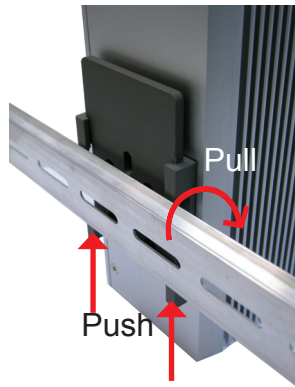

### 4.3. Ground the Computer

Follow the instructions below to ground the computer to land. Be sure to follow every grounding requirement in your place.



**Warning** Whenever the unit is installed, the ground connection must always be made first of all and disconnected lastly.

1. See the illustration below. Remove the ground screw from the side panel.
2. Attach a ground wire to the rear panel with the screw.

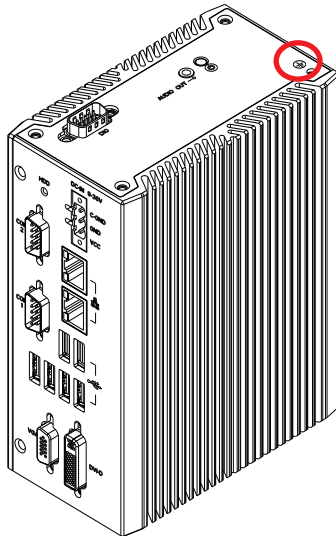



#### 4.4. Wire DC-in Power Source



**Warning** Only trained and qualified personnel are allowed to install or replace this equipment.

Follow the instructions below for connecting the computer to a DC-input power source.

1. Before wiring, make sure the power source is disconnected.
2. Find the terminal block in the accessory box.
3. Use the wire-stripping tool to strip a short insulation segment from the output wires of the DC power source.
4. Identify the positive and negative feed positions for the terminal block connection. See the symbols printed on the rear panel indicating the polarities and DC-input power range in voltage.
5. Insert the exposed wires into the terminal block plugs. Only wires with insulation should extend from the terminal block plugs. Note that the polarities between the wires and the terminal block plugs must be positive to positive and negative to negative.
6. Use a slotted screwdriver to tighten the captive screws. Plug the terminal block firmly, which wired, into the receptacle on the rear panel.

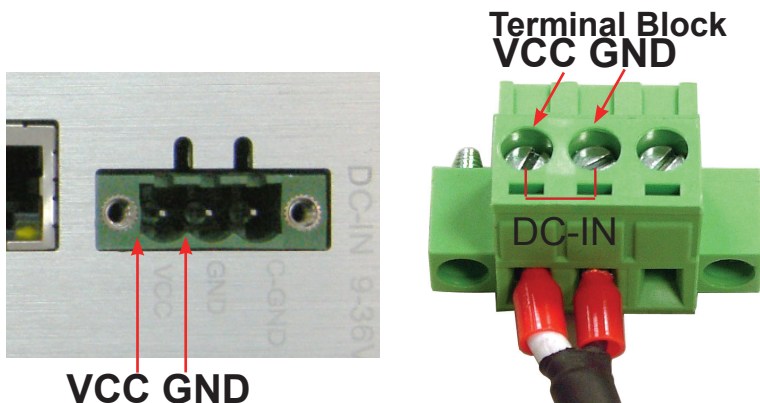

---

This page is intentionally left blank.

---

# Chapter 5

## BIOS

## BIOS

The BIOS Setup utility for the computer is featured by American Megatrends Inc to configure the system settings stored in the system's BIOS ROM. The BIOS is activated once the computer powers on. When the computer is off, the battery on the main board supplies power to BIOS RAM.

To enter the BIOS Setup utility, keep hitting the “Esc” key upon powering on the computer.



The BIOS featured menus are:

Menu	Description
<b>Main</b>	See <a href="#">5.1. Main</a> on page <a href="#">54</a> .
<b>Advanced</b>	See <a href="#">5.2. Advanced</a> on page <a href="#">55</a> .
<b>Security</b>	See <a href="#">5.3. Security</a> on page <a href="#">62</a> .
<b>Power</b>	See <a href="#">5.4. Power</a> on page <a href="#">63</a> .
<b>Boot</b>	See <a href="#">5.4.1 Advanced CPU Control</a> on page <a href="#">64</a> .
<b>Exit</b>	See <a href="#">5.6. Exit</a> on page <a href="#">66</a> .

## Key Commands

The BIOS Setup utility relies on a keyboard to receive user's instructions. Hit the following keys to navigate within the utility and configure the utility.

Keystroke	Function
← →	Moves left/right between the top menus.
↓ ↑	Moves up/down between highlight items.
<b>Enter</b>	Selects an highlighted item/field.
<b>Esc</b>	<ul style="list-style-type: none"> <li>▶ On the top menus: Use <b>Esc</b> to quit the utility without saving changes to CMOS. (The screen will prompt a message asking you to select <b>OK</b> or <b>Cancel</b> to exit discarding changes.</li> <li>▶ On the submenus: Use <b>Esc</b> to quit current screen and return to the top menu.</li> </ul>
<b>F5</b>	Increases current value to the next higher value or switches between available options.
<b>F6</b>	Decreases current value to the next lower value or switches between available options.
<b>F1</b>	Opens the <b>Help</b> of the BIOS Setup utility.
<b>F9</b>	Restore the Setup Default (The screen then prompts a message asking you to select <b>OK</b> or <b>Cancel</b> to restore to default.)
<b>F10</b>	Exits the utility saving the changes that have been made. (The screen then prompts a message asking you to select <b>OK</b> or <b>Cancel</b> to exit saving changes.)

Note: Pay attention to the “WARNING” that shows at the left pane onscreen when making any change to the BIOS settings.

This BIOS Setup utility is updated from time to time to improve system performance and hence the screenshots hereinafter may not fully comply with what you actually have onscreen.

# BIOS

## 5.1. Main

The **Main** menu features the settings of **System Date** and **System Time** and displays some BIOS info and system info.



The BIOS info displayed are:

Info	Description
<b>BIOS Version</b>	Delivers the computer's BIOS version.
<b>Project name</b>	Delivers the name of the project
<b>Build Date and Time</b>	Delivers the date and time when the BIOS Setup utility was created/updated.
<b>Platform firmware Information</b>	Delivers the Platform firmware Information

The featured settings are:

Setting	Description
<b>Language</b>	Select the current default language used by the InsydeH20
<b>System Time</b>	Sets system time.
<b>System Date</b>	Sets system date.

## 5.2. Advanced

Access the **Advanced** menu to manage the computer’s system configuration including the Super IO chip.

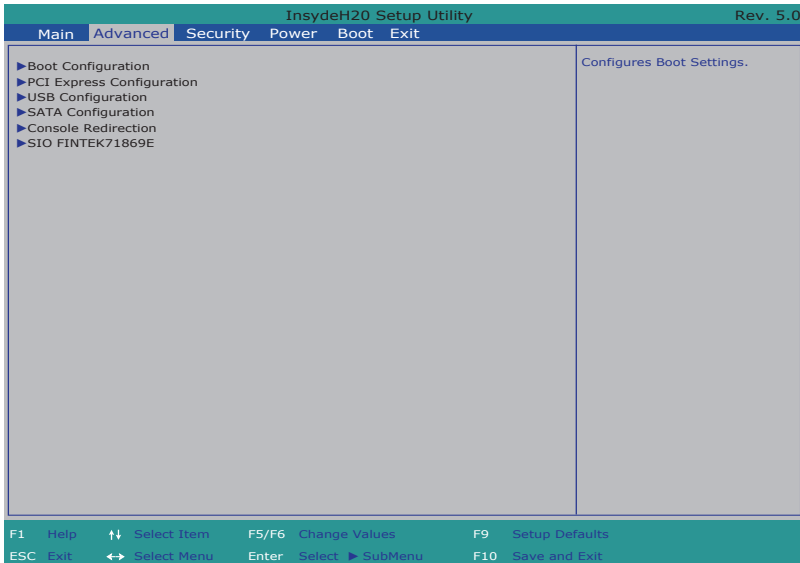

The featured settings and submenus are:

Setting	Description
<b>Boot Configuration</b>	See <a href="#">5.2.1. Boot Configuration on page 56</a>
<b>PCI Express Configuration</b>	See <a href="#">5.2.2. PCI Express Configuration on page 56</a>
<b>USB Configuration</b>	See <a href="#">5.2.3. USB Configuration on page 57</a>
<b>Video Configuration</b>	See <a href="#">5.2.4. Video Configuration on page 58</a>
<b>Thermal Configuration</b>	See <a href="#">5.2.5. Thermal Configuration on page 59</a>
<b>SATA Configuration</b>	See <a href="#">5.2.6. SATA Configuration on page 59</a>
<b>ACPI Table/Feature Control</b>	See <a href="#">5.2.7. ACPI Table/Feature Control on page 61</a>

### 5.2.1. Boot Configuration

Setting	Description
Numlock	Select Power-on state for Num lock

### 5.2.2. PCI Express Configuration

Configures PCI Express by the following settings:

Setting	Description
PCI Express Root Port 1/2/4	<ul style="list-style-type: none"><li>▶ PCI Express Root Port 1/2/4 Enables/disables this PCIe port.</li><li>▶ PCIe Port 1/2/4 Speed Options are: Auto, Gen 1, Gen 2 Auto is the default.</li><li>▶ PCIe Port 1/2/4 Support Options are: Disable : disables ASPM L0s : force all links to L0s state L1 : force all links to L1 state L0sL1 : force all links to L0s+L1 state Auto : BIOS auto configure</li></ul>



### 5.2.3. USB Configuration

Select this submenu to view the status of the USB ports and configure USB features.

The featured settings are:

Setting	Description
<b>XHCI Pre-Boot Mode Support</b>	Enables/Disables XHCI Pre-Boot mode support
<b>xHCI Mode</b>	Set the mode of operation of xHCI controller Options are Disabled/Enabled/Auto/Smart Auto(default)
<b>XHCI Controller</b>	Enables/Disables XHCI controller
<b>USB2 Link Power Management</b>	Enables/Disables USB2 Link Power Management.
<b>XHCI Streams</b>	Enables/disables XHCI Stream
<b>USB OTG Support</b>	Enables/disables USB OTG Support
<b>USB VBUS</b>	Turn ON/OFF USB VBUS. Turn ON in HOST mode, and turn OFF in OTG device mode.
<b>USB RMH Mode</b>	Enables/Disables PCH USB Rate Matching Hubs mode
<b>USB EHCI debug</b>	Enables/disables PCH EHCI debug capability
<b>USB Per-Port Controll</b>	Enables/Disables USB Per-port controll

### 5.2.4. SATA Configuration

Select this submenu to configure the SATA controller and HD.

Setting	Description
<b>SATA Controller</b>	Enables/disables the present SATA controller. ▶ <b>Enabled</b> is the default.
<b>Configures SATA Mode</b>	Configures how to run the SATA drives. ▶ Options available are <b>AHCI</b> (default) and <b>IDE</b> .
<b>SATA Speed</b>	Configures the SATA Speed. ▶ Options available are <b>Gen2</b> (default) and <b>Gen1</b> .
<b>Serial ATA Port 0</b>	Delivers the SATA port Media information and Security Mode.
<b>Serial ATA Port 1</b>	

### 5.2.5. Console redirection

Configure video settings

The featured setting is:

Setting	Description
<b>Console Serial Redirection</b>	Enables/disables the Console Serial Redirection
<b>Terminal Type</b>	Set the Terminal Type: Options are VT_100 (default): ASCII char set. VT_100+: Extends VT100 to support color, functional keys, etc. VT-UTF8: Uses UTF8 encoding to map unicode chars onto 1 or more bytes PC_ANSI: Extended ASCII char set.
<b>Baud Rate</b>	Set the Baud Rate Options are 1200 / 2400 / 4800 / 9600 / 14400 / 19200 / 28800 /38400 / 57600 / 115200 (default).
<b>Data Bits</b>	Set the Data Bits Options are 7 Bits / 8 Bits (default)
<b>Parity</b>	A parity bit can be sent with the data bits to detect some transmission errors. None: No parity bit Even: parity bit is 0 if the num of 1's in the data bits is even. Odd: parity bit is 0 if num of 1's in the data bits is odd. None is the default.
<b>Stop Bits</b>	Stop bits indicate the end of a serial data packet. (A start bit indicates the beginning). The standard setting is 1 stop bit. Communication with slow devices may require more than 1 stop bit. Options are 1 Bit(default) / 2 Bits
<b>Flow Control</b>	Flow control can prevent data loss from buffer overflow. When sending data, if the receiving buffers are full, a 'stop' signal can be sent to stop the data flow. Once the buffers are empty, a 'start' signal can be sent to restart the flow. Hardware flow control uses two wires to send start/stop signals. Software flow control uses start/stop ASCII chars, which slows down the data flow and can be problematic if binary data is being sent. Options are None(default) / RTS/CTS / XON.XOFF.

## BIOS

---

<b>Information Wait Time</b>	Set the Information Wait Time. Options are 0 Sec / 2 Sec / 5 Sec (default) / 10 Sec / 30 Sec.
<b>C.R After Post</b>	Enables/disables Console Redirection After Post
<b>AutoRefresh</b>	Enables/disables Auto Refresh. When it is enabled, screen will be auto refresh once after detect remote terminal connection.
<b>FailSafebaudRate</b>	Enables/disables Fail-safe Baud rate function. It will detect the remote terminal baud rate and connect C.R serial device with detected baud rate.
<b>ACPI SPCR Table</b>	Enables/disables ACPI SPCR Table. Serial Port redirection Table: When enabled, the SPCR table will be add-into ACPI Tables.
<b>COMA/B</b>	
<b>PortEnable</b>	Enables/disables COM A/B Console Serial Redirection
<b>UseGlobalSetting</b>	Enables/disables Global Setting
<b>Terminal Type</b>	Set the Terminal Type of COM A/B
<b>Baud Rate</b>	Set the Baud Rate of COM A/B
<b>Data Bits</b>	Set the Data Bits of COM A/B
<b>Parity</b>	Set the Parity of COM A/B
<b>Stop Bits</b>	Set the Stop Bits of COM A/B
<b>Flow Control</b>	Set the Flow Control of COM A/B

**5.2.6. SIO FINTEK71869E**

<b>Setting</b>	<b>Description</b>
<b>Serial Port A</b>	<ul style="list-style-type: none"><li>▶ Serial Port A Enables/disables the Serial port.</li><li>▶ RS-232/RS-422 Setting Set the mode of Serial port. Options are RS232 (default), RS-422</li><li>▶ Base I/O Address Setup the Base I/O Address of the Serial Port.</li><li>▶ Interrupt Setup the Interrupt of the Serial Port</li></ul>
<b>Serial Port B</b>	<ul style="list-style-type: none"><li>▶ Serial Port B Enables/disables the Serial port.</li><li>▶ RS-422/RS-485 Setting Set the mode of Serial port. Options are RS422 (default), RS-485</li><li>▶ Base I/O Address Setup the Base I/O Address of the Serial Port.</li><li>▶ Interrupt Setup the Interrupt of the Serial Port</li></ul>

# BIOS

## 5.3. Security

The **Security** menu sets up the TPM (Trusted Platform Module) device and password for the system's administrator account. Once the administrator password is set up, this BIOS Setup utility is limited to access and will ask for the password each time any access is attempted.

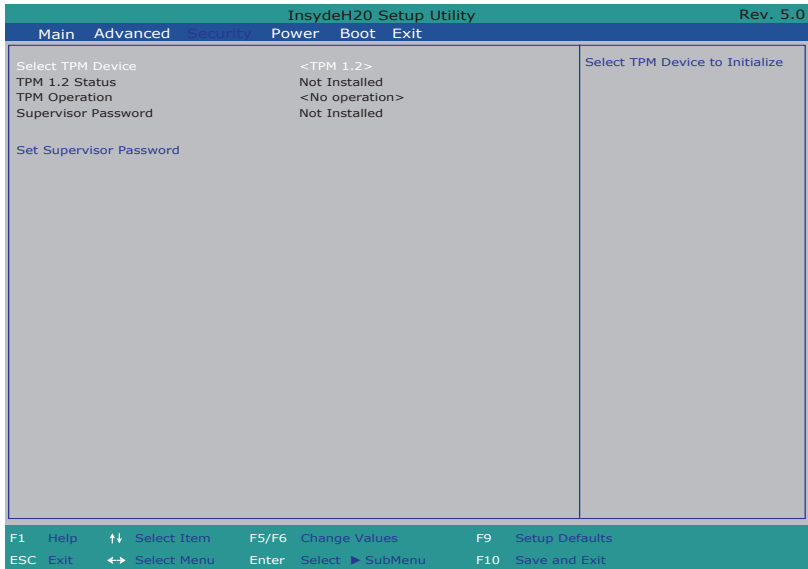

The featured setting is:

Setting	Description
<b>Set Supervisor Password</b>	To set up an administrator password: <ol style="list-style-type: none"><li>1. Select <b>Supervisor Password</b>. An <b>Set Supervisor Password</b> dialog then pops up onscreen.</li><li>2. Enter your desired password that is no less than 3 characters and no more than 20 characters.</li><li>3. Hit [Enter] key to submit.</li></ol>

## 5.4. Power

The **Security** menu sets up the password for the system's administrator account. Once the administrator password is set up, this BIOS Setup utility is limited to access and will ask for the password each time any access is attempted.

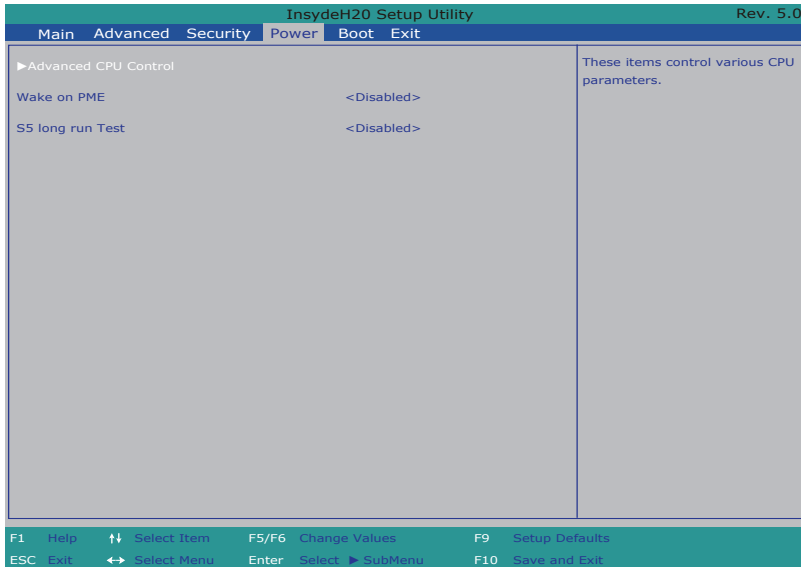

The featured setting is:

Setting	Description
<b>Wake on PME</b>	Enables or disables Wake on PME. Determines the action taken when the system power is off and a PCI Power Management Enable wake up event occurs.
<b>State After G3</b>	Set the state of System when power is re-applied after a Power failure (G3 state) Options are S0 State(default)/S5 State

## 5.5. Boot

The **Boot** menu configures how to boot up the system such as the configuration of boot device priority.

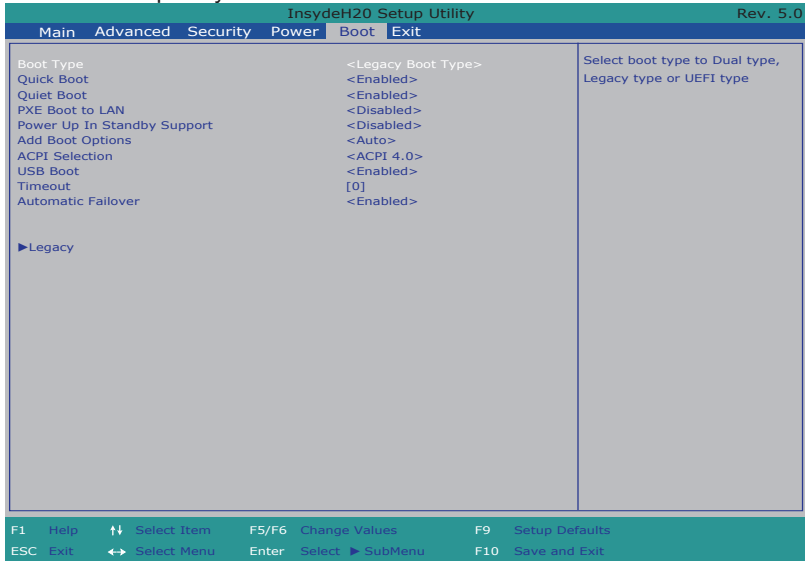

The featured settings are:

Setting	Description
<b>Quiet Boot</b>	Disables or enables booting in text mode.
<b>PXE boot to LAN</b>	Disables or enables PXE boot to LAN.
<b>APCI Selection</b>	Select boot to Acpi 3.0/Acpi 1.0B Options are Acpi 1.0B/Acpi 3.0/Acpi 4.0/Acpi 5.0
<b>Timeout</b>	Set the waiting seconds before booting the default boot selection



<b>Legacy</b>	<b>Boot Device Priority</b> <b>Normal Boot Menu</b> Select Normal boot option priority or Advance boot option Priority. <b>Boot type order</b> Change boot type order <b>Hard Disk Drive</b> Change CD/DVD-ROM Drive Boot order
---------------	---

# BIOS

## 5.6. Exit

The **Save & Exit** menu features a handful of commands to launch actions from the BIOS Setup utility regarding saving changes, quitting the utility and recovering defaults.

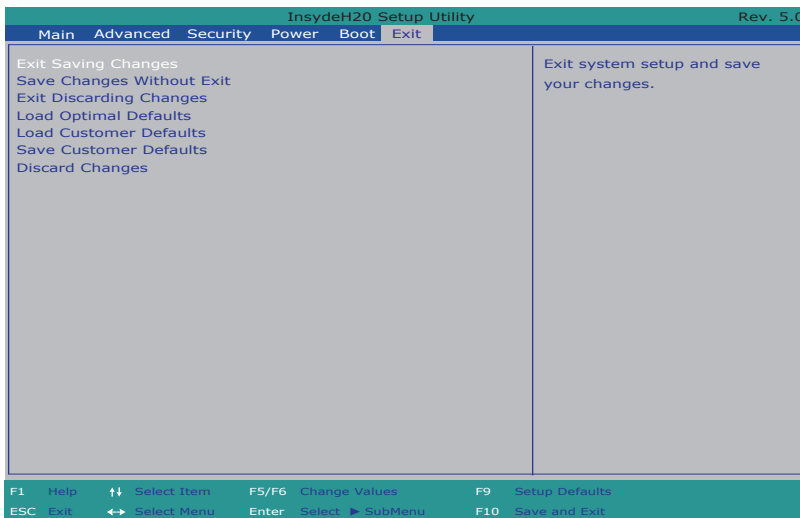

The features settings are:

Setting	Description
<b>Exit Saving Changes</b>	Saves the changes and quits the BIOS Setup utility.
<b>Save Changes Without Exit</b>	Save Changes but does not quit the BIOS.
<b>Exit Discard Changes</b>	Quits the BIOS Setup utility without saving the change(s).
<b>Load Optimal Defaults</b>	Restores all settings to defaults. ▶ This is a command to launch an action from the BIOS Setup utility rather than a setting.



# Appendices

## Appendix A: Install mSATA Storage

To install an mSATA storage module to the computer:

1. Remove the top cover from the computer as described in [4.1.1. Open the Computer](#) on page [40](#).

The inside of the computer comes to view.

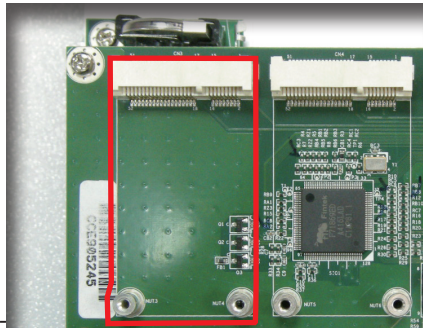

2. Find the socket for mSATA module as the picture above shows.
3. Confront the mSATA module's edge connector with the socket's connector. Align the module's key notch the connector's break.

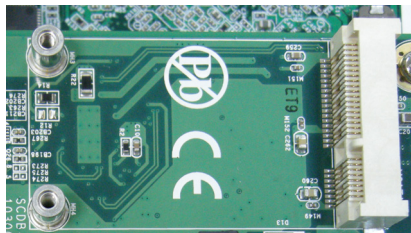

The module's key notch should meet the connector's break.

4. Fully plug the module until it cannot be plugged any more.



Fully plug the module.

5. Press the module down and fix the module in place using two screws.



6. Restore the upper cover to the computer.

## Appendix B: Wi-Fi Module WIFI-AT2300 Hardware Installation

To use Wi-Fi, hardware-wise the computer needs a Wi-Fi module installed, and software-wise the computer needs the device driver and an application program. This appendix will guide you to install the Wi-Fi module **WIFI-AT2300** and the device driver. (To have a copy of the device driver, please contact ARBOR customer service by the contact info described in [Technical Support](#) on page [viii](#).)

### B.1. Install WIFI-AT2300

1. Remove the computer's upper cover as described in [4.1.1. Open the Computer](#) on page [40](#).
2. Locate the PCI Express Mini-card socket on the daughter board.

The **PCI Express Mini-card** socket for wireless modules comes to view.

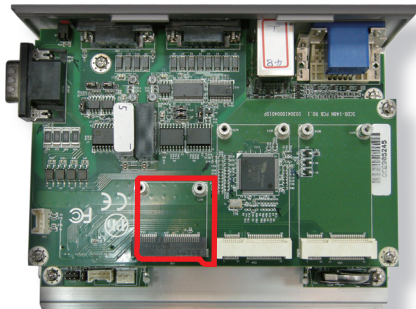

Note the socket has a break among the connector .

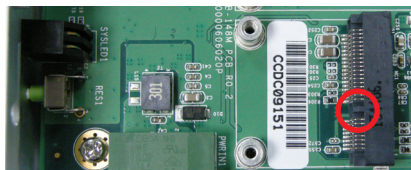

The module's key notch should meet the connector's break.

3. Prepare the **WIFI-AT2300** Wi-Fi module kit. The module is a half-size module of **PCI Express Mini-card** form factor, with two U.FL connectors, one is "1", and the other is "0".

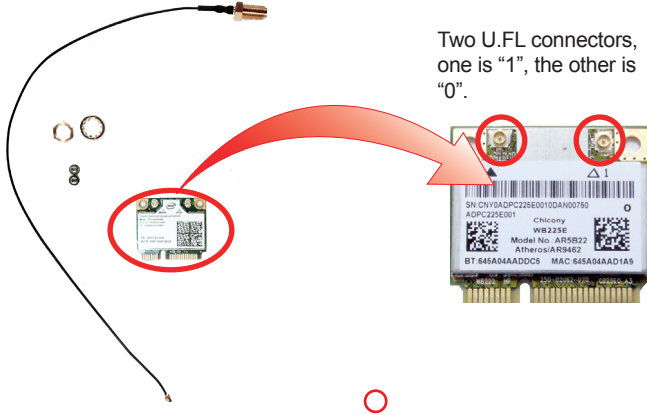

4. Plug the Wi-Fi module to the socket's connector by a slanted angle. Fully plug the module, and note the notch on the wireless module should meet the break of the connector.



Fully plug the module.

## Appendices

---

5. Press the module down and fix the module in place using two screws.



6. Remove a plastic plug from the computer's side panel to make an antenna hole. Keep the plastic plug for any possible restoration in the future.

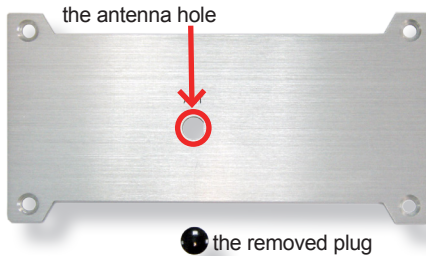

7. Have the RF antenna. The antenna has an SMA connector on one end and an MHF connector on the other.

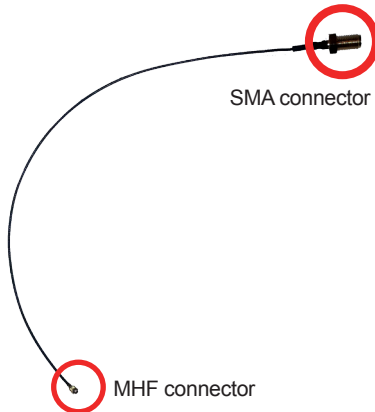



8. Connect the RF antenna's MHF connector to the Wi-Fi module's "1" connector.

Connect the RF antenna's MHF connector to the Wi-Fi module's "MAIN" connector



9. From the other end of the RF antenna, which is an SMA connector, remove the washer and the nut. Save the washer and nut for later use. Note the SMA connector has the form of a threaded bolt, with one flat side.

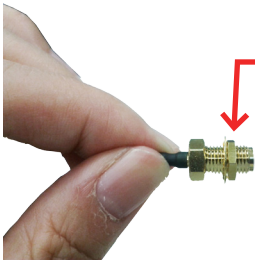

Remove the nut and washer.

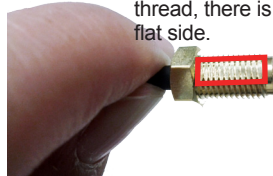

Among the screw thread, there is a flat side.

10. Pull the SMA connector through the above mentioned antenna hole. Note to meet the aforesaid flattened side with the antenna hole's flat side.

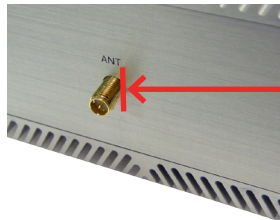
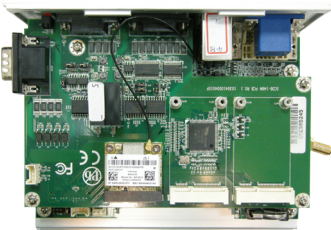

Arrange the flat side of the SMA connector to meet the flat side of the antenna hole.

## Appendices

---

11. Mount the washer first and then the nut to the SMA connector. Make sure the nut is tightened.

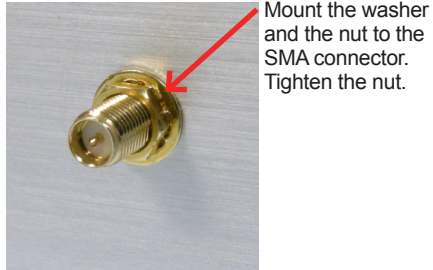

12. Restore the computer's side covers and top cover.

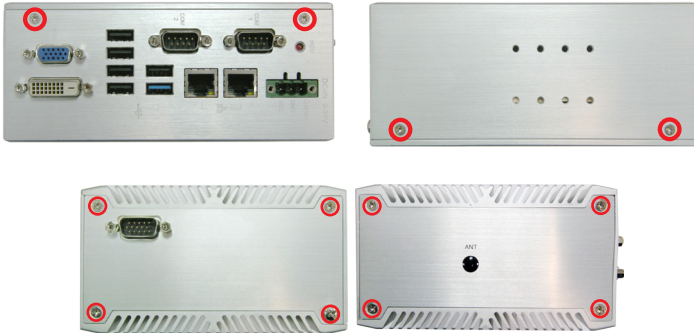

13. Have an external antenna. Screw and tightly fasten the antenna to the SMA connector.

