

PPC2-C17-EHL

IEI Heavy Industrial Panel PC

Powered by Intel® Elkhart Lake Platform



www.ieiworld.com



PPC2-C17-EHL

Panel PC equips Intel® Celeron® J6412 processor, on-board 8GB memory, HDMI display output, dual 2.5G Ethernet port, one M.2 M key & one M.2 B key expansion slots, 12~24V DC input, anti-glare and anti-UV 10-point touchscreen

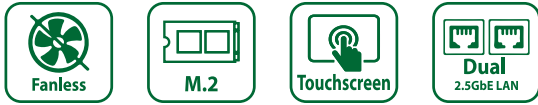

IP2EHL_XC Expansion Interface

The IP2EHL_XC connector allows users to flexibly expand functionality such as network, serial ports and CAN to meet various application requirements. (IEI-designed pin definition, supported functions are customized, for models of 10-inch or above)

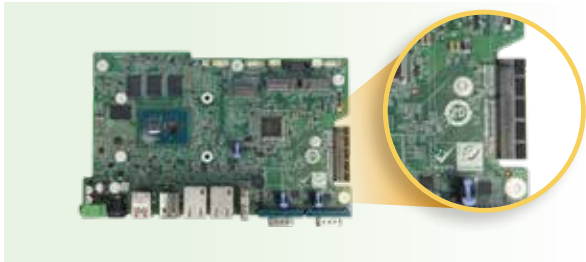

M.2 B Key & M.2 M Key

Dual M.2 ultra-high-speed expansion supporting SSD & AI accelerator to enhance efficiency

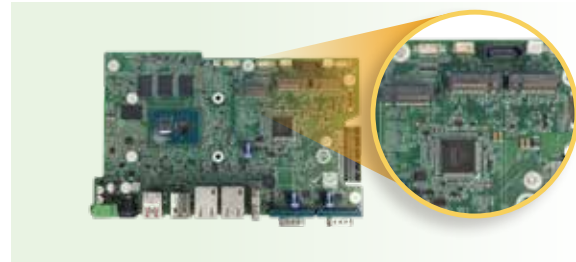

Anti-glare and Anti-UV PCAP

With anti-glare and anti-UV coating, the 10-point touchscreen can display clearly without reflection for a long time use in outdoors and bright light environment.



Support Gloved and Wet Hand Operation

The whole new PCAP screen allows you to accurately manage every step of your operations even with gloves or in wet conditions.



Newly Designed Panel Mount Kit

The new refined and convenient panel mount kit can be easily fastened by hand, no screwdriver required.



New Graphical BIOS Interface

Upgraded with new BIOS interface, which can be navigated with fingers, no keyboard and mouse are required to operate.

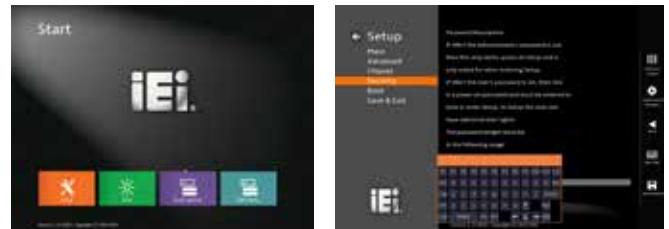

Fully Integrated I/O

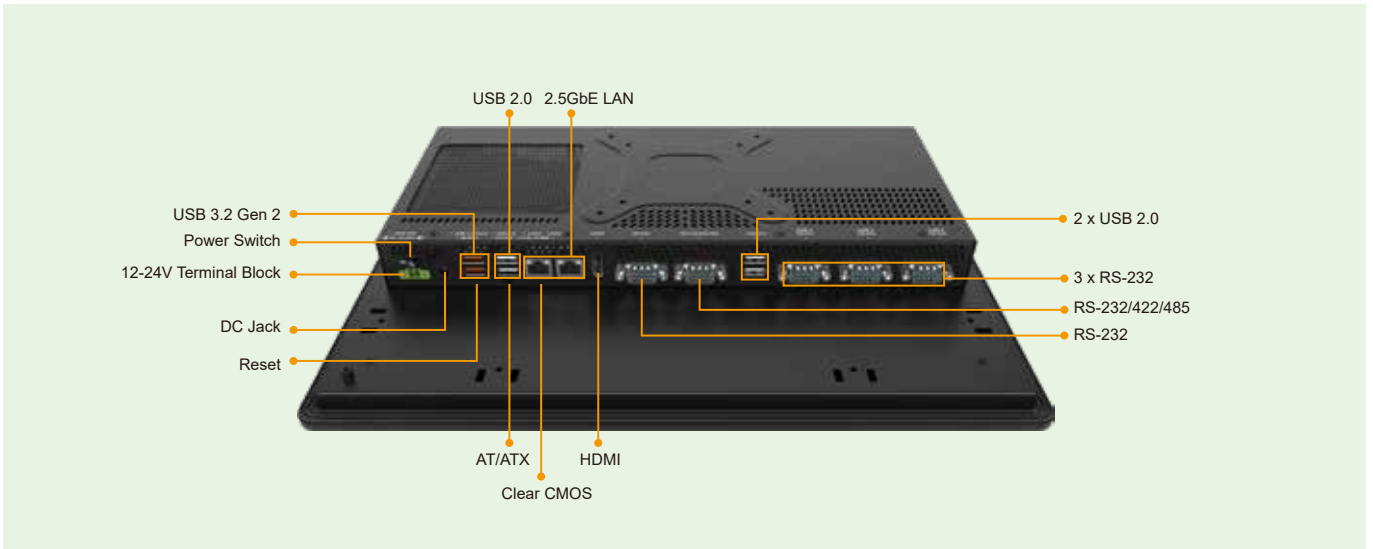

Block Diagram

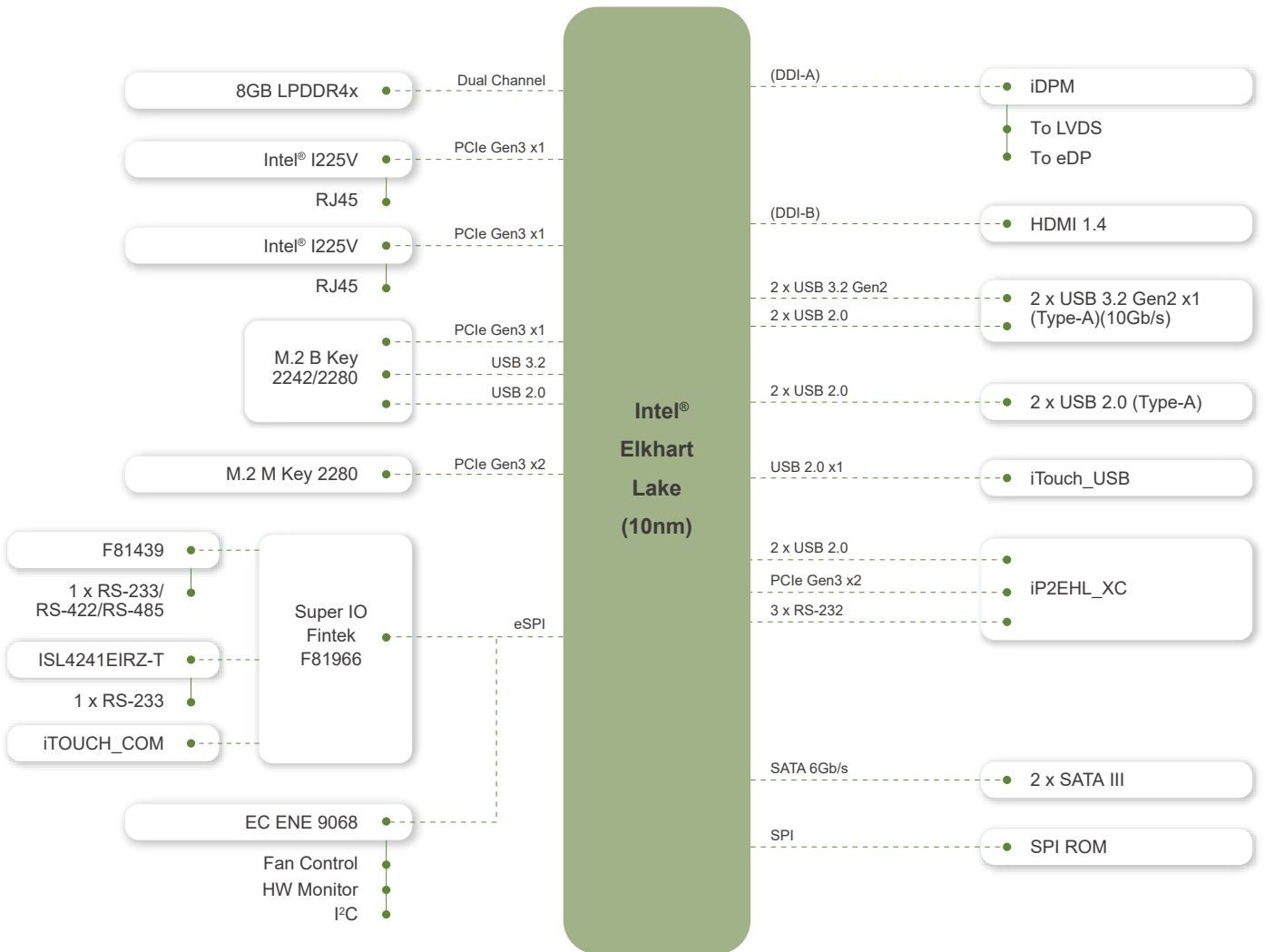

Dimensions (Unit: mm)

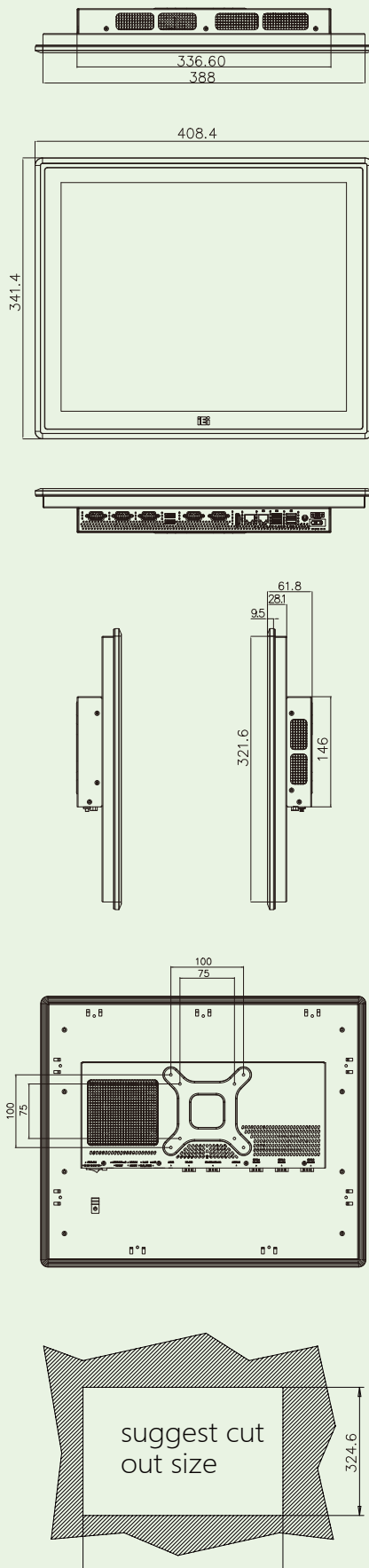

Specifications

	PPC2-C17-EHL																		
LCD Display	17" (5:4)																		
Resolution	1280 (W) x 1024 (H)																		
Brightness	350 cd/cm ²																		
Contrast Ratio	800:1																		
LCD Color	16.7M																		
Pixel Pitch (mm)	0.26 x 0.26																		
Viewing Angle (H-V)	170°/160°																		
Backlight MTBF	50,000 hours																		
SBC Model	PPC2MB2-EHL-RC-R10+PPC2-XIO-02-R10																		
CPU (SoC)	Intel® Celeron® Processor J6412 1.5M Cache, up to 2.60 GHz / TDP 10W																		
Memory	Dual-channel 8GB LPDDR4x on-board																		
Touchscreen	Multi-point projected capacitive type (anti-UV / anti-glare coating, support gloves) Surface hardness: ≥7H																		
Touch Controller	Projected capacitive type: EETI 80																		
Storage	1 x 2.5" HDD/SSD drive bay																		
Ethernet	2 x 2.5GbE LAN via Intel I225-V																		
Expansion	1 x M.2 2242/2280 B key (PCIe Gen3 x1 + USB 3.0) 1 x M.2 2280 M key (PCIe Gen3 x2)																		
Mounting	VESA 75/100 mm Panel, Wall, Rack, Stand and Arm																		
Construction Material	Aluminum front cover and sheet metal rear cover																		
Enclosure Color	Black																		
I/O Ports, Switches and Buttons	<table border="0"> <tr> <td>1 x HDMI output</td> <td>1 x Power button</td> </tr> <tr> <td>2 x RJ-45 2.5GbE</td> <td>1 x Reset button</td> </tr> <tr> <td>2 x USB 3.2 Gen 2x1 (10Gb/s)</td> <td>1 x Clear CMOS button</td> </tr> <tr> <td>2 x USB 2.0</td> <td>PPC2-XIO-02-R10:</td> </tr> <tr> <td>1 x RS-232/422/485</td> <td>2 x USB 2.0</td> </tr> <tr> <td>1 x RS-232</td> <td>3 x RS-232 DB9</td> </tr> <tr> <td>1 x 12V-24V power jack</td> <td>1 x M.2 B key 2242/2280</td> </tr> <tr> <td>1 x Power terminal block (2-pin)</td> <td>(PCIe Gen3 x 2 + USB 2.0)</td> </tr> <tr> <td>1 x AT/ATX switch</td> <td></td> </tr> </table>	1 x HDMI output	1 x Power button	2 x RJ-45 2.5GbE	1 x Reset button	2 x USB 3.2 Gen 2x1 (10Gb/s)	1 x Clear CMOS button	2 x USB 2.0	PPC2-XIO-02-R10:	1 x RS-232/422/485	2 x USB 2.0	1 x RS-232	3 x RS-232 DB9	1 x 12V-24V power jack	1 x M.2 B key 2242/2280	1 x Power terminal block (2-pin)	(PCIe Gen3 x 2 + USB 2.0)	1 x AT/ATX switch	
1 x HDMI output	1 x Power button																		
2 x RJ-45 2.5GbE	1 x Reset button																		
2 x USB 3.2 Gen 2x1 (10Gb/s)	1 x Clear CMOS button																		
2 x USB 2.0	PPC2-XIO-02-R10:																		
1 x RS-232/422/485	2 x USB 2.0																		
1 x RS-232	3 x RS-232 DB9																		
1 x 12V-24V power jack	1 x M.2 B key 2242/2280																		
1 x Power terminal block (2-pin)	(PCIe Gen3 x 2 + USB 2.0)																		
1 x AT/ATX switch																			
Power Input	12 V ~ 24 V DC																		
Power Adapter	60W power adapter																		
Thermal Solution	Fanless																		
TPM	Intel® Platform Trust Technology																		
Watchdog Timer	Software Programmable support 1~255 sec. system reset																		
Operating Temperature (with air flow)	-10°C ~ 60°C																		
Storage Temperature	-20°C ~ 60°C																		
Humidity	10% ~ 95%, non-condensing																		
IP Level	IP 65 compliant front panel																		
Safety and EMC	CE, FCC Class A, UKCA																		
ErP	ErP 2009/125/EC																		
Dimensions (H x W x D) (mm)	408.40 x 341.40 x 61.80																		
Net Weight	4.830kg																		

Packing List

1 x Power Cord	1 x Power Adapter	1 x QIG
1 x Panel Mount Kit	1 x Screw Pack	

Ordering Information

PPC2-C17-EHL-J1/8G-R10	17" 350 cd/cm ² 1280x1024 Panel PC with Intel® Celeron® Processor J6412, 8GB LPDDR4x on-board, HDMI output, black, 12-24V DC input, projected capacitive touchscreen with AG, R10
------------------------	--

Options

Item	Part No	Description
Arm	ARM-11-RS/ARM-31-RS	VESA 75/100 Desk ARM
Stand	STAND-C12-R10	VESA 75/100 Easy Stand
Wall Mount Kit	AFLWK-12/AFLWK-19B	Monitor Wall mounting kit
OS	PPC2-EHL-W10IoT21-E-R10	Win10 IoT Ent LTSC 2019 MultiLang OEI Entry