

IP66 Remote Temperature and Humidity Data Logger with LCD Display

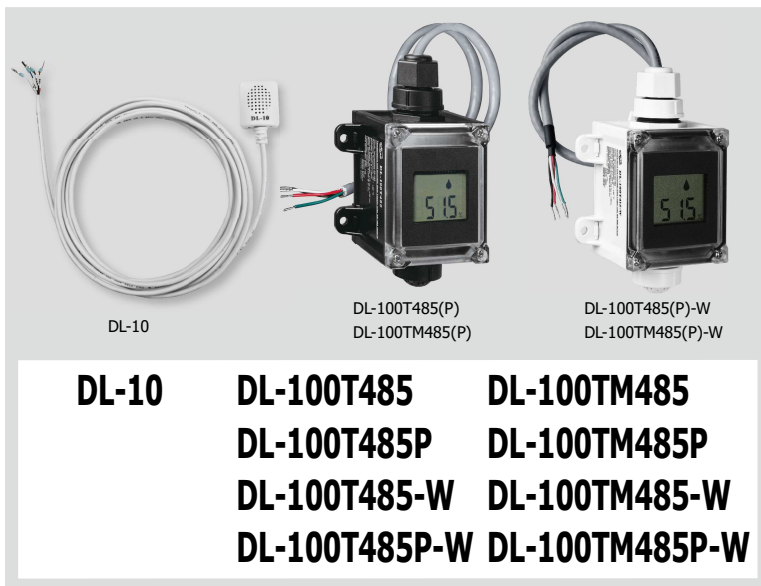

Features

- Measurement Ranges: -20 ~ +60°C and 0 ~ 100% RH
- Accuracy:
 - +/-0.4°C; +/-3.0% RH for non-P version
 - +/-0.3°C; +/-1.8% RH for P version
- LCD Display Shows Temperature, Humidity and Module ID
- 10 ~ 30 VDC Power Input
- IP66 Waterproof
- Data Logger Can Store Up to 4088 Temperature and Humidity Records
- RS-485 Communication interface
- DCON or Modbus RTU Protocol
- Windows Software Included



Introduction

The DL-100T485/DL-100T485P/DL-100T485-W/DL-100T485P-W/DL-100TM485/DL-100TM485P/DL-100TM485-W/DL-100TM485P-W is a temperature and humidity data logger module. It contains an RS-485 communication interface and an LCD display to show a variety of temperature, humidity and module ID data. The data storage memory can store up to 4088 temperature and humidity records.

The Data Logger Utility is included to allow installation, configuration, retrieval and display of data in a powerful chart format that can be exported to Excel.

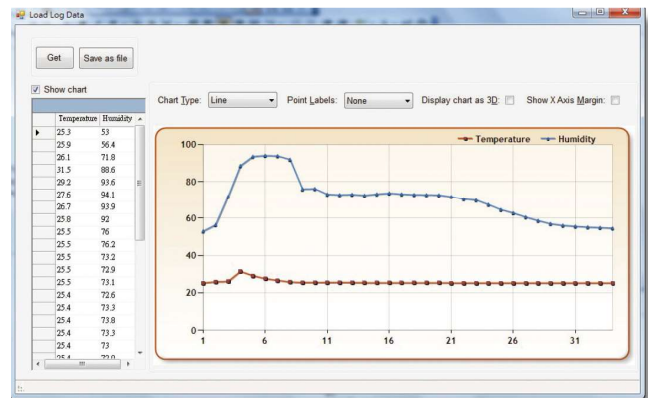

Applications

- Transportation of food or pharmaceuticals
- Food and beverage industry (HACCP)
- Blood stations, pharmacies
- Building and energy management
- Warehouses
- Museums, archives, galleries



Greenhouse Automation



Specifications

Models	DL-10	DL-100T485 DL-100T485-W	DL-100TM485 DL-100TM485-W	DL-100T485P DL-100T485P-W	DL-100TM485P DL-100TM485P-W
Temperature Sensor					
Measuring Range	-20 ~ +60°C (-31 ~ +176°F)				
Resolution	0.1°C				
Accuracy	Typical: ±0.4°C; refer to figure 2			Typical: ±0.3°C; refer to figure 2	
Precision	+/- 0.1°C				
Humidity Sensor					
Measuring Range	10 ~ 95% RH	0 ~ 100% RH			
Resolution	0.1% RH				
Accuracy	Typical: ±3% RH @ 20 ~ 80% RH; refer to figure 1			Typical: ±1.8% RH @ 10 ~ 90% RH; refer to figure 1	
Precision	+/- 0.1% RH				
LCD Display					
Displayed Information	-	Temperature (°C and °F), Humidity (RH), Module ID			
Data Logger					
Time Interval	-	10 seconds to 1 day			
Max. Records	-	4088 temperature and humidity records			
Mode	-	Overwrite or stop logging when storage space is full			
Overwrite Limitation	-	1,000,000 cycles			
Communication					
Interface	RS-485; non-isolated				
Baudrate	1200 ~ 115200 bps				
Data format	N,8,1				
Protocol	Modbus RTU	DCON	Modbus RTU	DCON	Modbus RTU
Max. Modules on same bus	32				
Power					
Input Range	+10 ~ 30 Vdc				
Power Consumption	0.05 W	0.15 W			
Mechanical					
Dimensions (W x L x H)	25 mm X 20.2 mm X 30 mm	82 mm x 126 mm x 55 mm			
Waterproof Level	-	IP66			
Installation	Magnetic mount; Wall mount	DIN-Rail; Wall mount			
Environment					
Operating Temperature	-20 ~ +60°C				
Storage Temperature	-30 ~ +80°C				
Ambient Relative Humidity	5 ~ 95% RH, Non-condensing				

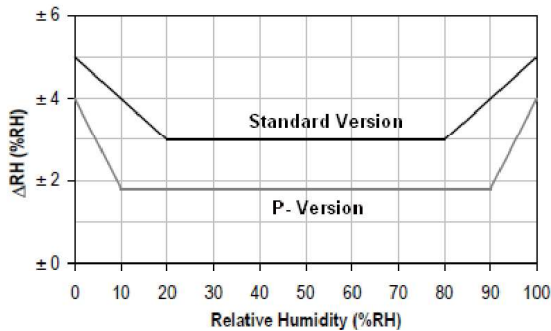

Figure 1: Maximum RH-tolerance at 25°C per sensor.

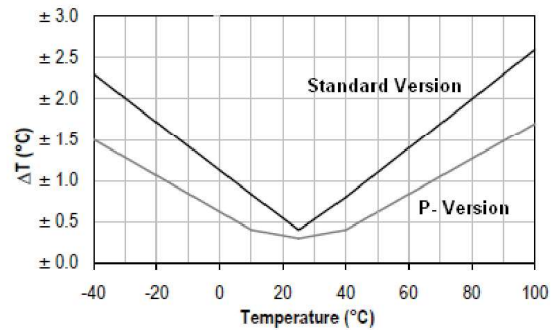
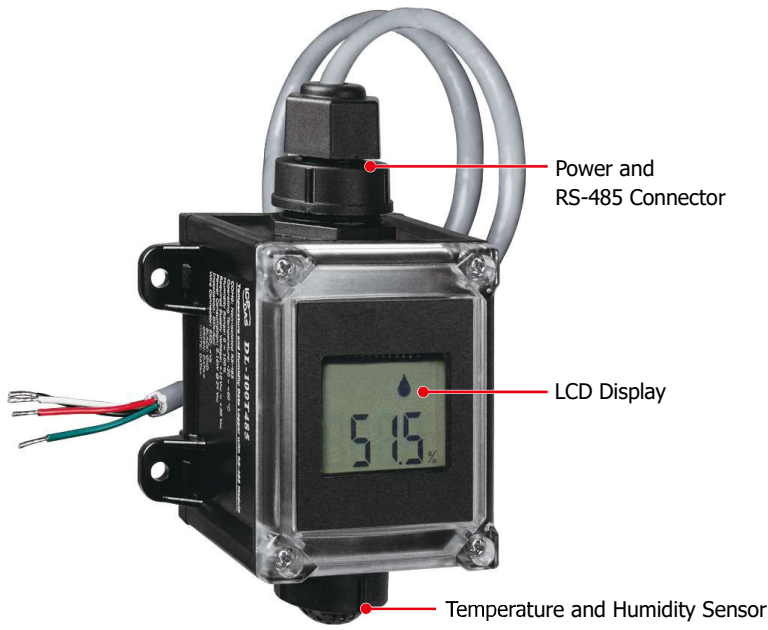

Figure 2: Maximum T-tolerance per sensor.

Installation



■ Appearance



Humidity (RH)



Module ID



Temperature (°F)



Temperature (°C)

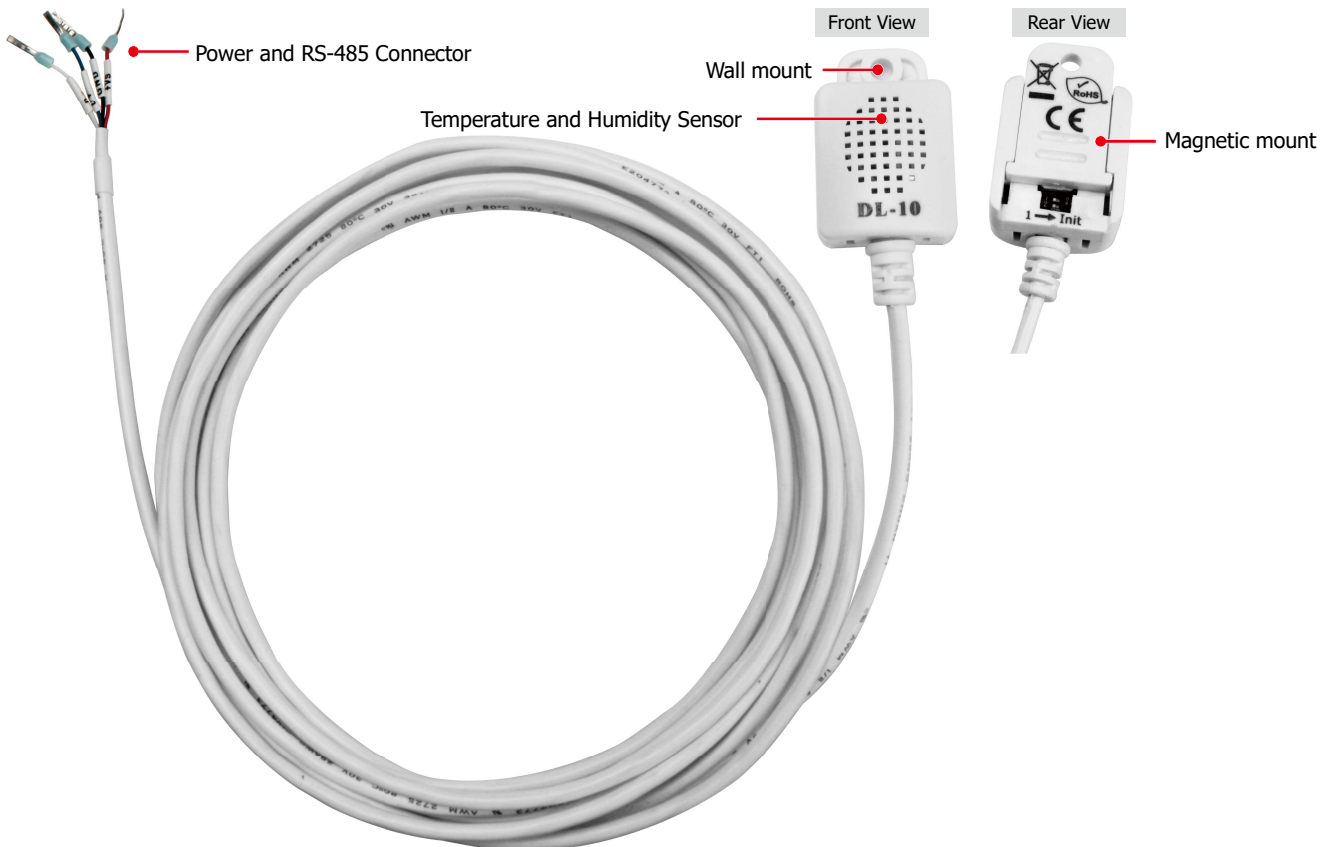

■ Dimensions (Units: mm)

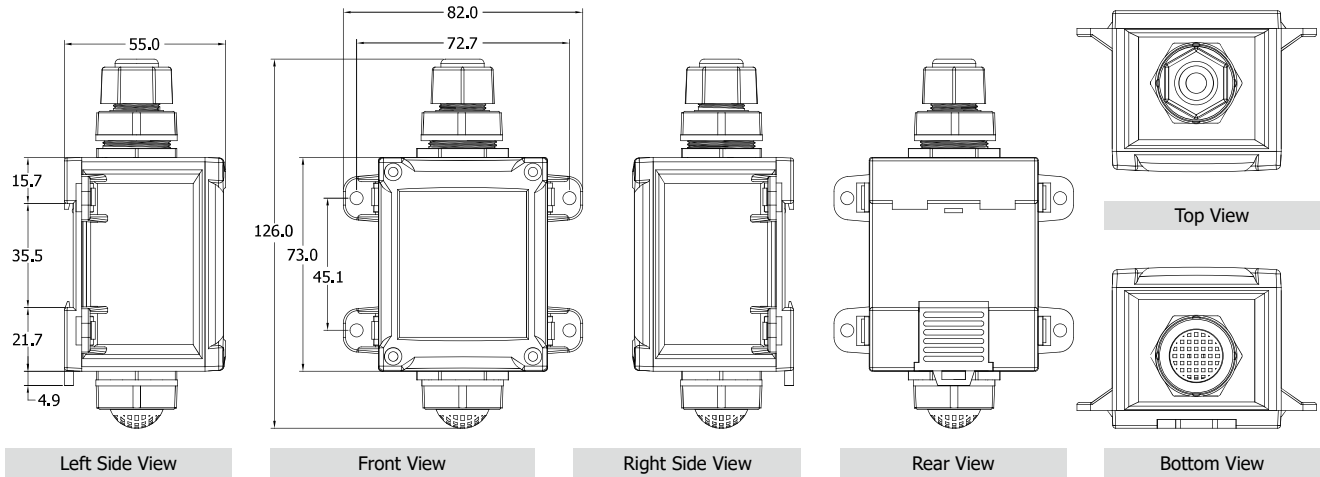

■ Ordering Information

DL-10 CR	RS-485 Remote Temperature and Humidity (RoHS)
DL-100T485 CR	DCON Protocol Based IP66 RS-485 Remote Temperature and Humidity Data Logger with LCD Display (Black Cover) (RoHS)
DL-100TM485 CR	Modbus RTU Protocol Based IP66 RS-485 Remote Temperature and Humidity Data Logger with LCD Display (Black Cover) (RoHS)
DL-100T485-W CR	DL-100T485 (White Cover) (RoHS)
DL-100TM485-W CR	DL-100TM485 (White Cover) (RoHS)
DL-100T485P CR	DL-100T485 (High Accuracy) (Black Cover) (RoHS)
DL-100TM485P CR	DL-100TM485 (High Accuracy) (Black Cover) (RoHS)
DL-100T485P-W CR	DL-100T485 (High Accuracy) (White Cover) (RoHS)
DL-100TM485P-W CR	DL-100TM485 (High Accuracy) (White Cover) (RoHS)

■ Optional Accessories

tM-7561 CR	Isolated USB to RS-485 Converter (RoHS)
tM-7520U CR	Isolated RS-232 to RS-485 Converter (RoHS)
MDR-20-24 CR	24V/1A, 24 W Power Supply with DIN-Rail Mounting (RoHS)