

## QBIP-1235A (MADU5AS)

3.5" SubCompact Board with 12th Generation Intel® Core™ i5-1235U Processor, Dual Channel DDR4 memory, 4 x COM, 1 x SATA 6Gb/s, 4 x USB 3.2 Gen 2x1, 4 x USB 2.0

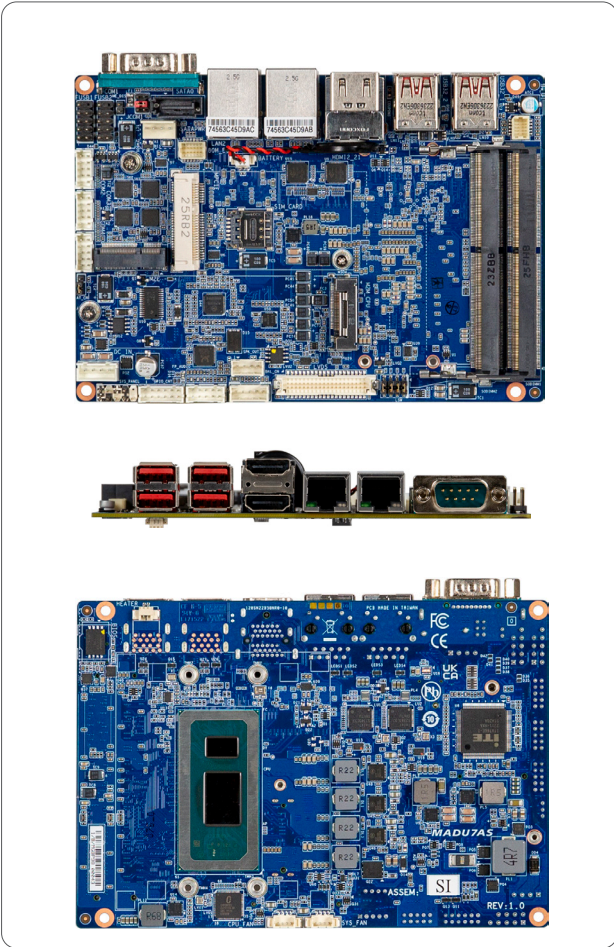

### Features

- 3.5" SBC
- Intel® Core™ i5-1235U Processor
- Dual Channel DDR4, 2 x SO-DIMMs
- 2 x 2.5GbE LAN Ports
- 1 x SATA 6Gb/s Port
- Ultra-Fast M.2 with PCIe Gen 4x4 interface
- 2 x HDMI, LVDS ports for multiple display
- 1 x COM Port (RS-232/422/485 & RI/5V/12V)
- 3 x COM Ports (RS-232/422/485)
- 4 x USB 3.2 Gen 2x1

### Specifications

Form Factor	3.5" SBC 146W x 101.7Dmm
CPU	Intel® Core™ i5-1235U Processor 10nm Enhanced Superfin (Intel 7), 10 cores, 12 threads, up to 4.4 GHz TDP 15W
Socket	1 x FCBGA1744
Memory	2 x DDR4 SO-DIMM sockets, Max. Capacity 64 GB Support Dual Channel DDR4 3200MHz memory modules
Ethernet	2 x 2.5GbE LAN Ports (Intel® I226V)
Video	Integrated Graphics Processor - Intel® Iris® Xe Graphics: 2 x HDMI 2.0 ports, supporting a maximum resolution of 4096x2160 @60Hz 1 x LVDS port, supporting a maximum resolution of 1920x1200 @60Hz  (3 independent display outputs)
Audio	Realtek® Audio Codec
Storage	1 x SATA 6Gb/s Port
Raid	Intel® SATA RAID 0/1

Expansion Slots	1 x 2280 M.2 M-Key (PCIe Gen 4x4, SATA 6Gb/s) 1 x 2230 M.2 E-Key 1 x Full-size Mini PCIe with SIM slot
Internal I/O	1 x 4-pin box power connector (DC in +9V~36VDC) 1 x SATA Power header 1 x CPU fan header 1 x System fan header 1 x Front panel header 1 x Front panel audio header 1 x 2W Speaker out header 4 x USB 2.0 headers 3 x COM headers (RS-232/422/485) 1 x Backlight Control header 1 x AT/ATX mode select jumper 1 x GPIO (8 bits) & SMBus header
Rear I/O	1 x COM Port (RS-232/422/485 & RI/5V/12V) 2 x HDMI 2 x RJ45 LAN Ports 4 x USB 3.2 Gen 2x1
TPM	1 x TPM header (SPI)
OS Compatibility	Windows 10/11 (x64)
Operating Properties	Operating temperature: 0°C to 60°C Operating humidity: 0-90% (non-condensing) Non-operating temperature: -40°C to 85°C Non-operating humidity: 0%-95% (non-condensing)
Packing Content	Carton size: 465 x 351 x 217 (mm) Packing Capacity: 10pcs  Single Box size: 221 x 178 x 65 (mm)  Including: SATA power cable x 1 (P/N: 25CRI-200B02-K1R)
Order Information	9MADU5ASMR-SI (Box Packing)

GIGAIPC reserves the right to modify or change technical data without prior notice.

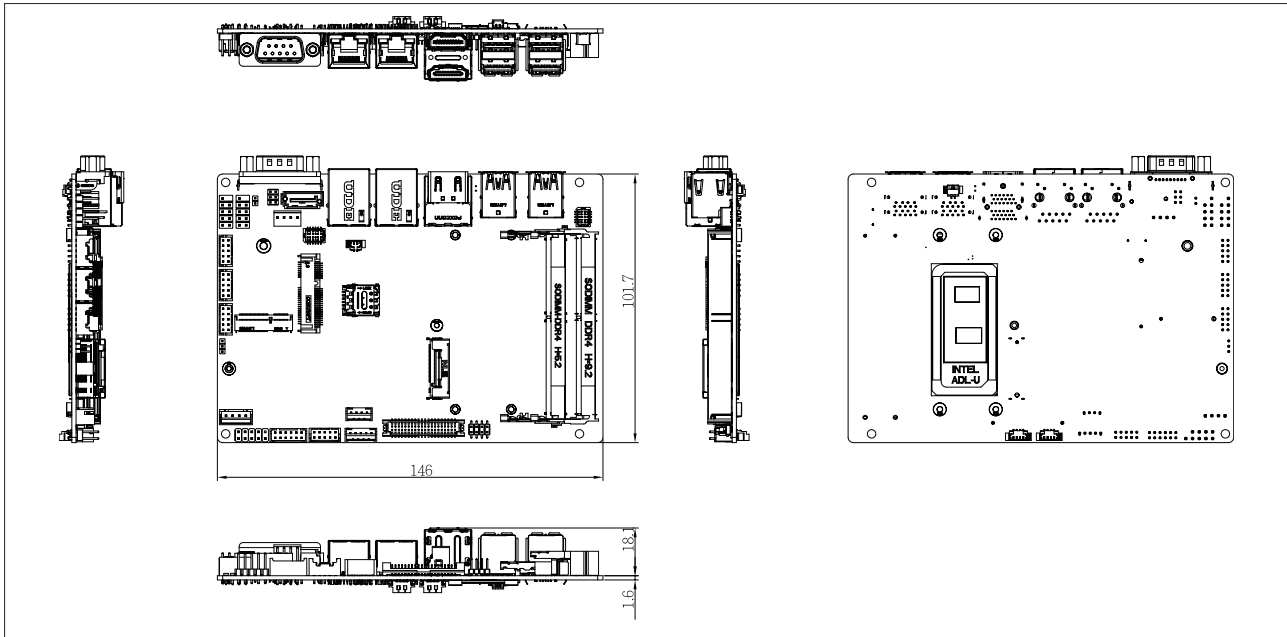

## Block Diagram

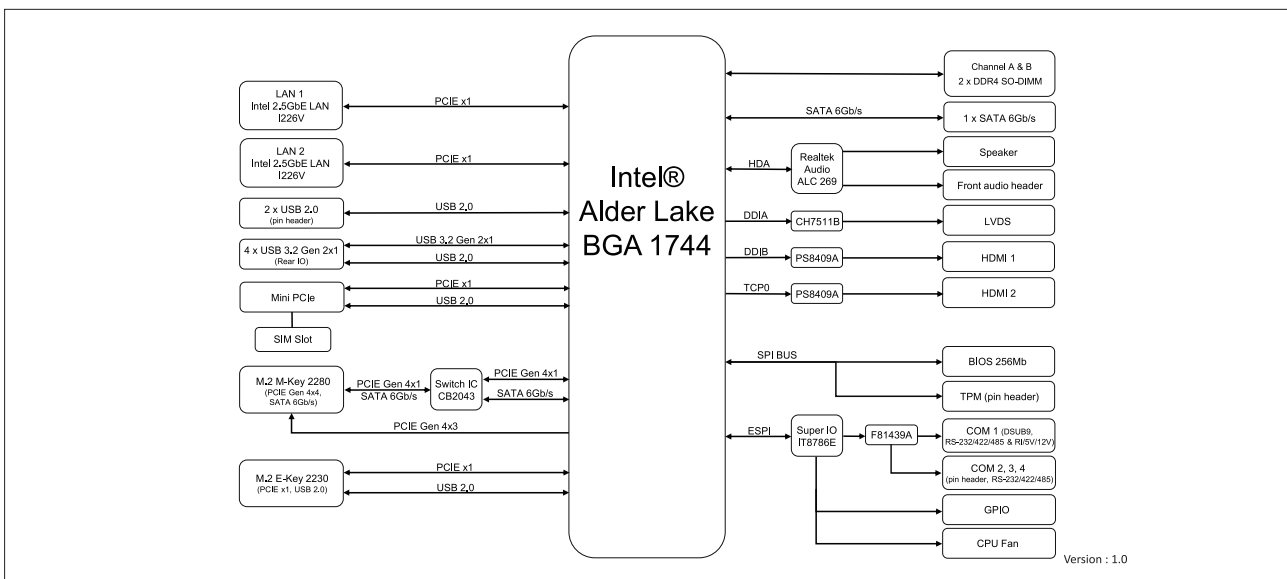

## Optional Kit

Part No.	Description	Quantity
25ST4-113104-A7R	Fansink	1
25ST1-113110-A7R	Fanless sink	1
25ST5-MADU00-Y0R	Heat spreader	1
9CTM010NR-00	TPM 2.0 module	1
25CRZ-100600-S9R	TPM cable	1

GIGAIPC reserves the right to modify or change technical data without prior notice.