

8-Port 10/100/1000/2500T 802.3at PoE+ + 1-Port 10G SFP+ Multigigabit Ethernet Switch (120 Watts)

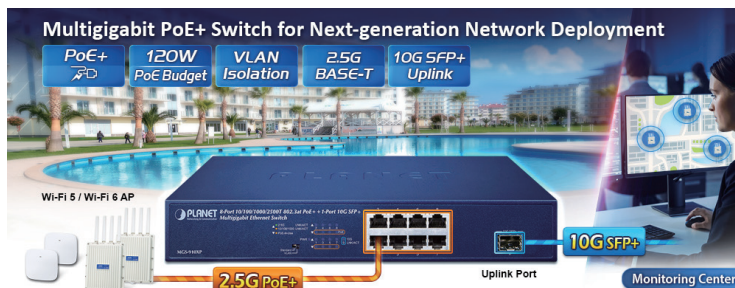

Value-added 2.5Gbps PoE+ Switch for a Quick Solution

PLANET MGS-910XP ideal value-added multigigabit switch providing data rates of **2.5Gbps** and PoE over UTP cables is designed for the demand of high-bandwidth required network equipment, such as 802.11ax and 802.11ac Wave 2 wireless AP. Offering a perfect hardware configuration with 8 **10/100/1000/2500BASE-T** ports featuring **32-watt** 802.3at PoE+, and 1 extra **10GBASE-X SFP+** fiber port, the MGS-910XP breaks the bandwidth limitation of connecting the wireless network with the wired network.



By offering reliable switching technology and advanced networking features, the MGS-910XP optimizes the installation and power management of network devices such as wireless access points, VoIP phones, and security cameras. It also eliminates time and cost of deployment by integrating power and data switching into one unit and freeing network devices from restrictions of power outlet locations and the additional AC wiring. Therefore, the MGS-910XP can handle extremely large amounts of data transmission in a secure topology linking to a backbone or high-power servers.

Unleash the 2.5Gbps bandwidth and the highest performance of the device

With the terminal access rates of 802.11ax Wi-Fi 6 and 802.11ac wireless APs reaching as high as 1.2Gbps to 2.6Gbps, Gigabit ports have been unable to satisfy the demand. Supporting 10/100/1G/2.5Gbps capability, the MGS-910XP can deliver not only data to 802.11ac wireless APs, but also takes both cost and performance into consideration, users can use the CAT 5e cable in the original environment to

Physical Port

- Eight 10/100/1000/2500BASE-T RJ45 copper ports with 802.3at PoE+ injector function
- One 10GBASE-X SFP+ port

Layer 2 Features

- Complies with IEEE 802.3 10BASE-T, IEEE 802.3u 100BASE-TX, IEEE 802.3ab 1000BASE-T and IEEE 802.3bz 2500BASE-T Ethernet standards
- Features Store-and-Forward mode with wire-speed filtering and forwarding rates
- Integrated address look-up engine, supporting **4K** absolute MAC addresses
- **12K** jumbo packet support
- Hardware-based **DIP switch** for **Standard** or **VLAN** mode selection;
 - **VLAN** mode: Ports 1~8 cannot communicate with each other, but can communicate with the uplink port 9
- Power saving ability for Green networking
- IEEE 802.1Q VLAN packet transparency support
- IEEE 802.3x flow control for full duplex operation and back pressure for half duplex operation
- Automatic address learning and address aging

Power over Ethernet

- Complies with IEEE 802.3at Power over Ethernet Plus end-span PSE
- Up to 8 ports of IEEE 802.3af / 802.3at devices powered (ports 1~8)
- Supports PoE power up to **32 watts** for each PoE port, with a total PoE budget of **120W**.
- Each port supports 54V DC power to PoE powered device.
- Auto detects powered device (PD)
- Circuit protection prevents power interference between ports.

increase the network speed to 2.5Gbps with an economical budget. Therefore, all devices in the network environment can give full play to their respective advantages.

New Generation of Multigigabit Switch

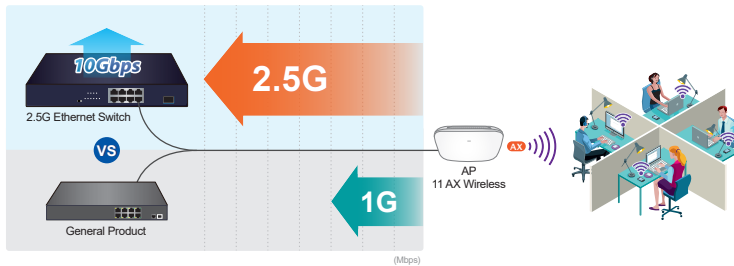

Hardware Features

- 0 to 50 degrees C operating temperature
- 100~240V AC, 3A, 50~60Hz universal power input
- 12-inch desktop size, 19-inch rack mountable for user-friendly installation
- LED indicators for system power, per port PoE ready and PoE activity, speed, Link/Act
- 1 fan to provide stable and efficient power performance
- Supports contact discharge of ±6KV DC and air distance discharge of ±8KV DC for Ethernet ESD protection
- Supports ±6KV surge immunity

Flexible and Extendable 10Gb Ethernet Solution

With its 10GBASE-X fiber-optic link capability, the administrator now can flexibly choose the suitable SFP+ transceiver according to the transmission distance or the transmission speed required to extend the network efficiently and provides broad bandwidth, distance range and powerful processing capacity

Perfect Integrated Solution for PoE IP Surveillance

The MGS-910XP brings you an ideally secure surveillance system at a lower total cost. The MGS-910XP provides 8 10/100/1000/2500Mbps 802.3at PoE+ ports able to provide sufficient PoE power to 8 IEEE 802.3af/IEEE 802.3at PoE+ IP cameras at the same time. It is also able to connect with one 8-channel NVR, uplinked 10GBASE-X SFP+ port to backbone switch and the monitoring center. With such a high-performance switch architecture, the recorded video files from the PoE IP cameras can be saved to the NVR system where the administrator can control and monitor the surveillance images in both the local LAN and remote sites.

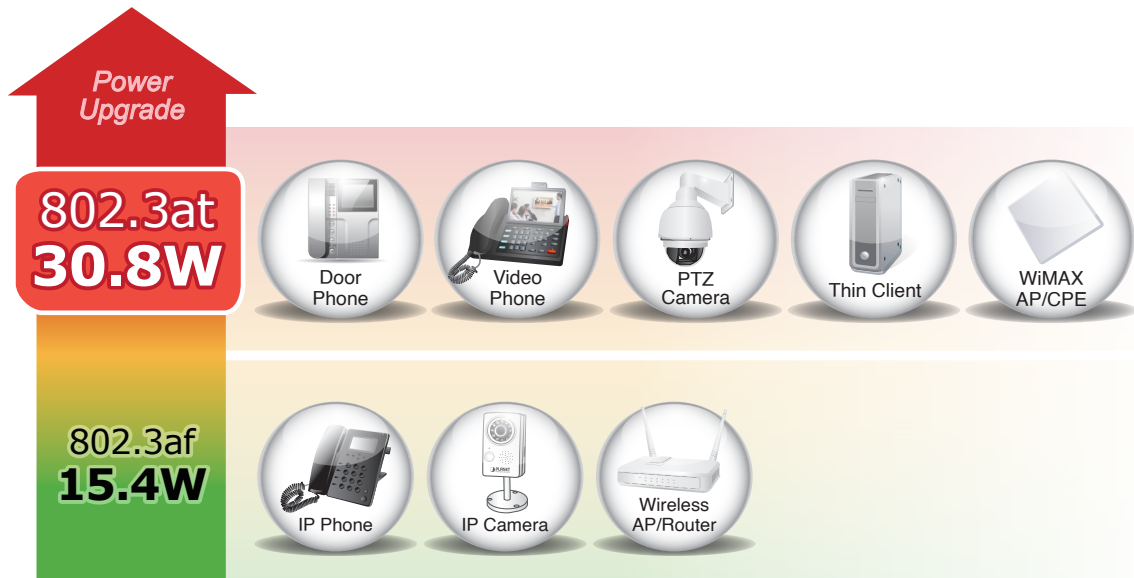

Ethernet Data Transmission Distance Extension

The DIP switch provides “Standard” and “VLAN” operation modes.

- The MGS-910XP operates as a normal switch in the “Standard” operation mode.
- The “VLAN” operation mode features port-based VLAN function that helps to prevent the IP camera’s multicast or broadcast storm from influencing each other.

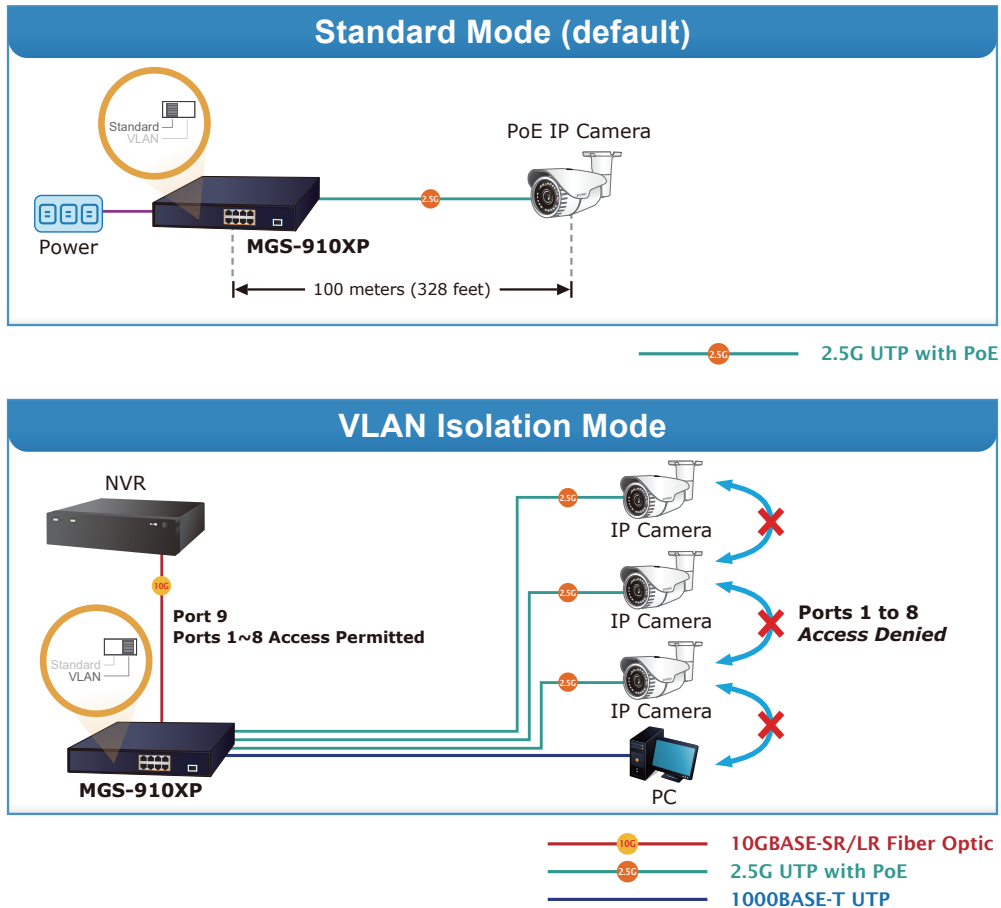

Plug & Play

All RJ45 copper interfaces of the MGS-910XP support 10/100/1000/2500Mbps auto-negotiation for optimal speed detection through RJ45 Category 5, 5e or 6 cables. They support standard auto-MDI/MDI-X feature which can detect the type of connection to any Ethernet device without requiring special straight-through or crossover cables.

Applications

Perfectly Integrated Solution for IP PoE Camera and NVR System

With its 60Gbps high-performance switch architecture and 120-watt PoE power budget, the MGS-910XP easily provides high bandwidth for both today's and future requirements. The recorded video files from the 8 PoE IP cameras and wireless access points powered by the MGS-910XP can be saved in the multi-channel NVR systems or surveillance software at the monitoring center.

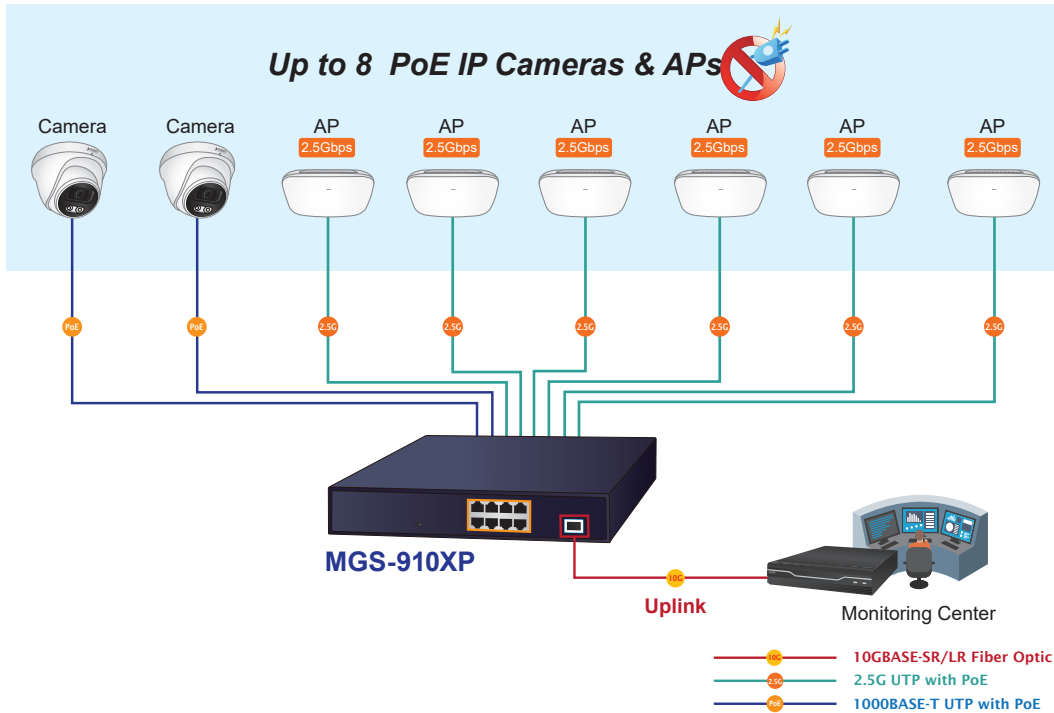

Department / Workgroup PoE Network

Providing 8 PoE in-line power interfaces, the MGS-910XP can easily build a power that can centrally control IP phone system, IP camera system and wireless AP group for the enterprise. Wireless APs and cameras can be installed around the corner in the company or campus for wireless network deployment and surveillance demands. Without the power-socket limitation, the MGS-910XP makes the installation of devices easier and more efficient.

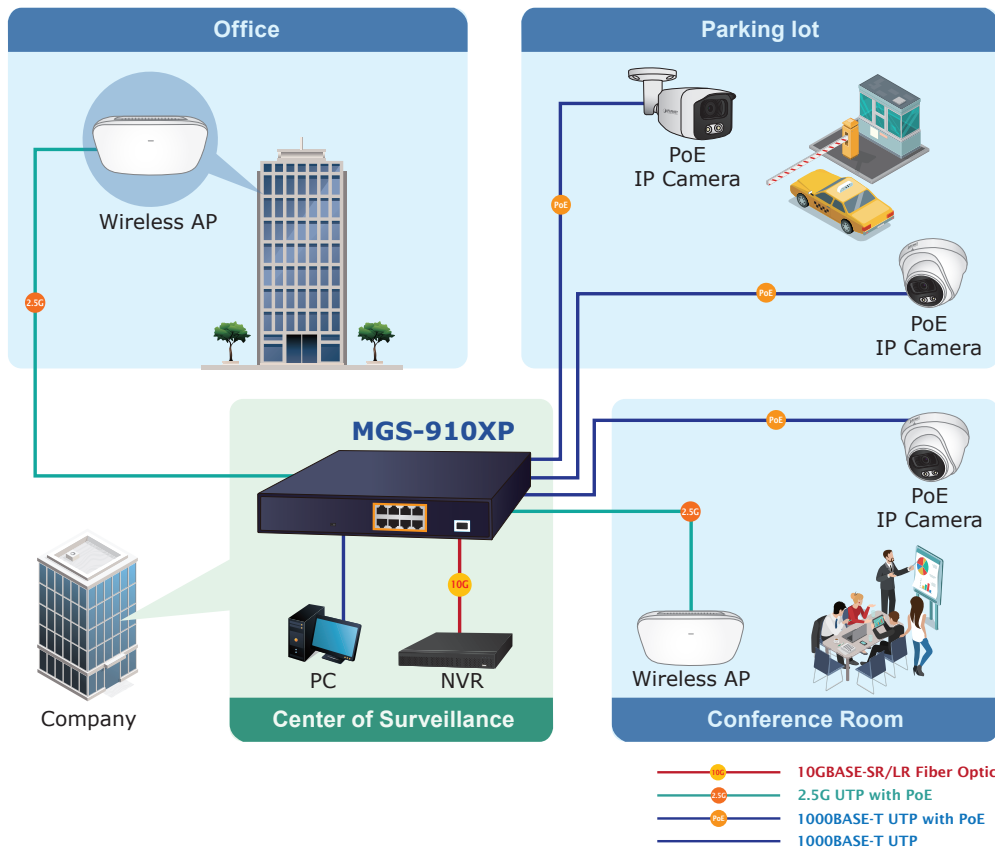

Specifications

| | |
|--|--|
| Product | MGS-910XP |
| Hardware Specifications | |
| 10/100/1000/2500BASE-T Copper Interfaces | 8 |
| 10GBASE-X SFP+ interface | 1 |
| DIP Switch | Selectable operation mode <ul style="list-style-type: none"> ■ Standard ■ VLAN |
| LED | System <ul style="list-style-type: none"> ■ Power (Green) 10/100/1000/2500T RJ45 Interfaces <ul style="list-style-type: none"> ■ 10/100/1000 LNK / ACT(Amber) ■ 2500 LNK / ACT (Green) ■ PoE-in-Use(Amber) 10G SFP+ Interface <ul style="list-style-type: none"> ■ LNK / ACT (Green) |
| Weight | 1739g |
| Power Requirements | 100~240V AC, 3A, 50-60Hz |
| Power Consumption/Dissipation | 140 watts/447.6BTU |
| Thermal Fan | 1 |
| Dimensions (W x D x H) | 280 x 180 x 44mm |
| ESD Protection | Contact discharge of ±6KV DC, Air discharge of ±8KV DC |
| Surge Protection | ±6KV |
| Switching | |
| Switch Architecture | Store-and-Forward |
| Switch Fabric | 60Gbps |
| Switch Throughput@64bytes | 44.64Mpps |
| MAC Address Table | 4K entries |
| Jumbo Frame | 12K |
| Flow Control | IEEE 802.3x pause frame for full duplex; back pressure for half duplex |
| Power over Ethernet | |
| PoE Standard | IEEE 802.3at Power over Ethernet Plus/PSE |
| PoE Injector Ports | 8 |
| PoE Power Supply Type | End-span: 1/2 (+), 3/6 (-) |
| PoE Power Output | Per port 54 DC, 300mA. max. 15.4 watts (IEEE 802.3af) Per port 54V DC, 600mA. max. 32 watts (IEEE 802.3at) |
| PoE Power Budget | 120 watts |
| Number of PDs, 7 watts | 8 |
| Number of PDs, 15.4 watts | 7 |
| Number of PDs, 30 watts | 4 |
| Standards Conformance | |
| Regulatory Compliance | FCC Part 15 Class A, CE |
| Standards Compliance | IEEE 802.3 (Ethernet) IEEE 802.3u (Fast Ethernet) IEEE 802.3ab (Gigabit Ethernet) IEEE 802.3bz (2.5Gigabit Ethernet) IEEE 802.3ae 10Gbps Ethernet IEEE 802.3x (Full-Duplex Flow Control) IEEE 802.3af Power over Ethernet IEEE 802.3at Power over Ethernet Plus IEEE 802.3az Energy Efficient Ethernet (EEE) |
| Environment | |
| Temperature | Operating: 0~50 degrees C Storage: -10~70 degrees C |
| Humidity (non-condensing) | Operating: 5% to 95% Storage: 5% to 95% |

Dimensions

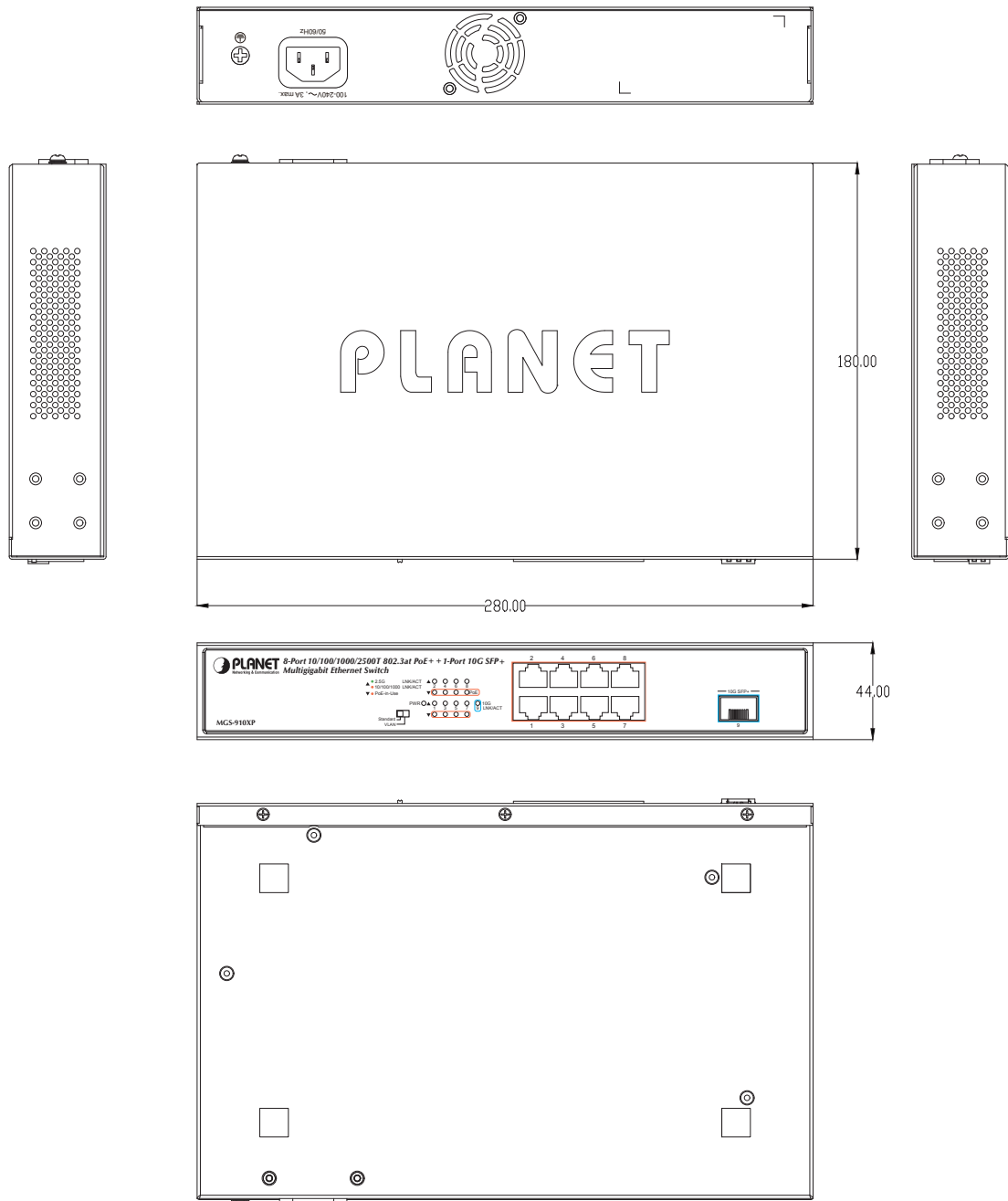

Unit: mm

Ordering Information

| | |
|-----------|--|
| MGS-910XP | 8-Port 10/100/1000/2500T 802.3at PoE+ + 1-Port 10G SFP+ Multigigabit Ethernet Switch (120 Watts) |
|-----------|--|

Related Products

| | |
|----------------|---|
| MGS-910X | 8-Port 10/100/1000/2500T + 1-Port 10G SFP+ Multigigabit Ethernet Switch |
| GSD-1222VHP | 8-Port 10/100/1000T 802.3at PoE + 2-Port 10/100/1000T + 2-Port 1000X SFP Ethernet Switch with PoE LCD Monitor |
| FGSD-1022VHP | 8-Port 10/100TX 802.3at PoE + 2-Port Gigabit TP/SFP combo Desktop Switch with LCD PoE Monitor (120W) |
| MGS-5220-8P2X | L2+ 8-Port 2.5G 802.3at PoE + 2-Port 1G/10G SFP+ Managed Multigigabit Switch |
| GS-5220-8P2T2X | L3 8-Port 10/100/1000T 802.3at PoE + 2-Port 10/100/1000T + 2-Port 10G SFP+ Managed Switch |

Available 10Gbps Modules

| | |
|---------------|--|
| CB-DASFP-0.5M | 10G SFP+ Directly-attached Copper Cable (0.5m in length) |
| CB-DASFP-2M | 10G SFP+ Directly-attached Copper Cable (2m in length) |
| MTB-SR | 10GBASE-SR mini-GBIC module - 300m |
| MTB-LR | 10GBASE-LR mini-GBIC module – 10km |
| MTB-LA20 | 10GBASE-LX (WDM,TX:1270nm) mini-GBIC module - 20km |
| MTB-LB20 | 10GBASE-LX (WDM,TX:1330nm) mini-GBIC module - 20km |
| MTB-LA40 | 10GBASE-LX (WDM,TX:1270nm) mini-GBIC module - 40km |
| MTB-LB40 | 10GBASE-LX (WDM,TX:1330nm) mini-GBIC module - 40km |
| MTB-LA60 | 10GBASE-LX (WDM,TX:1270nm) mini-GBIC module - 60km |
| MTB-LB60 | 10GBASE-LX (WDM,TX:1330nm) mini-GBIC module - 60km |