



NEXCOM International Co., Ltd.

Mobile Computing Solutions

Vehicle Telematics & Railway Computer

VTC 1020 and nROK 1020 Series

User Manual

CONTENTS

Preface

Copyright	v
Disclaimer	v
Acknowledgements	v
Regulatory Compliance Statements	v
Declaration of Conformity	v
RoHS Compliance	vi
Warranty and RMA	vii
Safety Information	ix
Installation Recommendations	ix
Safety Precautions	x
Technical Support and Assistance	xi
Conventions Used in this Manual	xi
Global Service Contact Information	xii
Package Contents	xiv
Package Contents	xv
Package Contents	xvi
Ordering Information	xvii

Chapter 1: Product Introduction

Physical Features	1
VTC 1020 Front View	1
VTC 1020 Rear View	1
Physical Features	2
VTC 1020-PA Front View	2
VTC 1020-PA Rear View	2

Physical Features	3
nROK 1020 Front View	3
nROK 1020 Rear View	3
VTC 1020 Overview	4
VTC 1020 Key Features	4
VTC 1020-PA Overview	5
VTC 1020-PA Key Features	5
nROK 1020 Overview	6
nROK 1020 Key Features	6
Hardware Specifications	7
Mechanical Dimensions	13
VTC 1020	13
VTC 1020-PA	14
nROK 1020	15
Connector Numbering	16
VTC 1020 Front View	16
VTC 1020 Rear View	16
VTC 1020-PA Front View	17
VTC 1020-PA Rear View	17
nROK 1020 Front View	18
nROK 1020 Rear View	18

Chapter 2: External Connectors Pinout Description

VGA Connector	19
Reset Switch	19
Dual USB 3.0 Ports	20

HDMI	20
LED Indicators.....	21
Power Button	21
Mini-SIM Card Slot	22
LVDS Connector (VTC 1020-PA).....	22
Front Audio-Out 2 & 3 Connectors (VTC 1020-PA).....	23
DC Power Input (nROK 1020).....	23
Audio Connector (nROK 1020)	24
M12 LAN Port (nROK 1020).....	24
DC Power Input	25
12V DC Output	25
Multi Port Connector.....	26
COM Connector.....	26
LAN Port.....	27
Rear Audio-Out 1 Connector	27
Rear Audio-In 1 Connector.....	28

Chapter 3: Jumpers and Connectors

Before You Begin	29
Precautions	29
Jumper Settings	30
Locations of the Jumpers and Connectors	31
Top View.....	31
Bottom View.....	32
Connector Pin Definitions	33
CMOS Clear Switch.....	33
GPIO Pull High Switch	33
WWAN/WLAN Module Selector.....	34
Input Voltage Control Switch	34
RTC Battery Connector.....	35
Debug 80 Port Connector	35
SATA Power Connector	36

SATA Connector.....	36
MCU Debug Port	37
MCU Download Port.....	37
GPS Connector	38
GPS DR Connector	38
Full Size Mini-PCIe Socket (PCIe 2.0, USB 2.0, mSATA)	39
Full Size Mini-PCIe Socket (USB 2.0) for LTE Module with 1 x External SIM	40

Chapter 4: System Setup

Opening the Enclosure.....	41
Installing a SO-DIMM.....	42
Installing the Wi-Fi Module	42
Installing the WWAN Module.....	43
Installing a SSD/HDD Drive	43
Inserting the SIM Card	45

Appendix A: Software Demo Utility for I/O Ports of Function Control

Menu Screen	46
Config1.....	46
Config2.....	46
1. Config1	47
2. Config2	48
3. Config3	49
4. G-Sensor.....	50
5. Tracker	51

Appendix B: GPS Feature.....54

uBlox-NEO M8N Overview	54
Technical Specifications	54

Appendix C: GPS with Dead Reckoning Feature (For VTC 1020 Series)

uBlox-NEO M8L Overview	56
Technical Specifications	57

Appendix D: Signal Connection of Programmable DI/DO

Multi Port Pinout Description	59
GPIO and CAN Terminal Setting	59
Digital Input.....	60
Digital Output.....	61

Appendix E: Vehicle Power Management Setup

Entering BIOS Menu.....	62
Startup and Shutdown Voltage Setting	62
Power-on Delay Setting.....	64
Power-off Delay Setting	66

Appendix F: Power Consumption

Appendix G: Pin Definition for the Multiport and COM Cable

Multiport Cable	69
P0 Connector Pinout.....	70
P1 to P3 Connector Pinouts	70

DR Connector (For VTC 1020 Series).....	70
RS-232 (Tx/Rx) Connector	71
CAN/GPIO Connector	71
COM Cable.....	72
P0 Connector Pinout.....	73
P1 to P6 Connector Pinouts	73
RS-232 (Tx/Rx) Connector	73
RS-232 (Tx/Rx) Connector	74
RS-232 (Tx/Rx) Connector	74
RS-232 (Tx/Rx) Connector	75
RS-485 Connector	75
RS-485 Connector	76

PREFACE

Copyright

This publication, including all photographs, illustrations and software, is protected under international copyright laws, with all rights reserved. No part of this manual may be reproduced, copied, translated or transmitted in any form or by any means without the prior written consent from NEXCOM International Co., Ltd.

Disclaimer

The information in this document is subject to change without prior notice and does not represent commitment from NEXCOM International Co., Ltd. However, users may update their knowledge of any product in use by constantly checking its manual posted on our website: <http://www.nexcom.com>. NEXCOM shall not be liable for direct, indirect, special, incidental, or consequential damages arising out of the use of any product, nor for any infringements upon the rights of third parties, which may result from such use. Any implied warranties of merchantability or fitness for any particular purpose is also disclaimed.

Acknowledgements

VTC 1020 and nROK 1020 series are trademarks of NEXCOM International Co., Ltd. All other product names mentioned herein are registered trademarks of their respective owners.

Regulatory Compliance Statements

This section provides the FCC compliance statement for Class A devices and describes how to keep the system CE compliant.

Declaration of Conformity

FCC

This equipment has been tested and verified to comply with the limits for a Class A digital device, pursuant to Part 15 of FCC Rules. These limits are designed to provide reasonable protection against harmful interference when the equipment is operated in a commercial environment. This equipment generates, uses, and can radiate radio frequency energy and, if not installed and used in accordance with the instructions, may cause harmful interference to radio communications. Operation of this equipment in a residential area (domestic environment) is likely to cause harmful interference, in which case the user will be required to correct the interference (take adequate measures) at their own expense.

CE

The product(s) described in this manual complies with all applicable European Union (CE) directives if it has a CE marking. For computer systems to remain CE compliant, only CE-compliant parts may be used. Maintaining CE compliance also requires proper cable and cabling techniques.

RoHS Compliance



NEXCOM RoHS Environmental Policy and Status Update

NEXCOM is a global citizen for building the digital infrastructure. We are committed to providing green products and services, which are compliant with European Union RoHS (Restriction on Use of Hazardous Substance in Electronic Equipment) directive 2011/65/EU, to be your trusted green partner and to protect our environment.

RoHS restricts the use of Lead (Pb) < 0.1% or 1,000ppm, Mercury (Hg) < 0.1% or 1,000ppm, Cadmium (Cd) < 0.01% or 100ppm, Hexavalent Chromium (Cr6+) < 0.1% or 1,000ppm, Polybrominated biphenyls (PBB) < 0.1% or 1,000ppm, and Polybrominated diphenyl Ethers (PBDE) < 0.1% or 1,000ppm.

In order to meet the RoHS compliant directives, NEXCOM has established an engineering and manufacturing task force to implement the introduction of green products. The task force will ensure that we follow the standard NEXCOM development procedure and that all the new RoHS components and new manufacturing processes maintain the highest industry quality levels for which NEXCOM are renowned.

The model selection criteria will be based on market demand. Vendors and suppliers will ensure that all designed components will be RoHS compliant.

How to recognize NEXCOM RoHS Products?

For existing products where there are non-RoHS and RoHS versions, the suffix "(LF)" will be added to the compliant product name.

All new product models launched after January 2013 will be RoHS compliant. They will use the usual NEXCOM naming convention.

Warranty and RMA

NEXCOM Warranty Period

NEXCOM manufactures products that are new or equivalent to new in accordance with industry standard. NEXCOM warrants that products will be free from defect in material and workmanship for 2 years, beginning on the date of invoice by NEXCOM.

NEXCOM Return Merchandise Authorization (RMA)

- Customers shall enclose the “NEXCOM RMA Service Form” with the returned packages.
- Customers must collect all the information about the problems encountered and note anything abnormal or, print out any on-screen messages, and describe the problems on the “NEXCOM RMA Service Form” for the RMA number apply process.
- Customers can send back the faulty products with or without accessories (manuals, cable, etc.) and any components from the card, such as CPU and RAM. If the components were suspected as part of the problems, please note clearly which components are included. Otherwise, NEXCOM is not responsible for the devices/parts.
- Customers are responsible for the safe packaging of defective products, making sure it is durable enough to be resistant against further damage and deterioration during transportation. In case of damages occurred during transportation, the repair is treated as “Out of Warranty.”
- Any products returned by NEXCOM to other locations besides the customers’ site will bear an extra charge and will be billed to the customer.

Repair Service Charges for Out-of-Warranty Products

NEXCOM will charge for out-of-warranty products in two categories, one is basic diagnostic fee and another is component (product) fee.

System Level

- Component fee: NEXCOM will only charge for main components such as SMD chip, BGA chip, etc. Passive components will be repaired for free, ex: resistor, capacitor.
- Items will be replaced with NEXCOM products if the original one cannot be repaired. Ex: motherboard, power supply, etc.
- Replace with 3rd party products if needed.
- If RMA goods can not be repaired, NEXCOM will return it to the customer without any charge.

Board Level

- Component fee: NEXCOM will only charge for main components, such as SMD chip, BGA chip, etc. Passive components will be repaired for free, ex: resistors, capacitors.
- If RMA goods can not be repaired, NEXCOM will return it to the customer without any charge.

Warnings

Read and adhere to all warnings, cautions, and notices in this guide and the documentation supplied with the chassis, power supply, and accessory modules. If the instructions for the chassis and power supply are inconsistent with these instructions or the instructions for accessory modules, contact the supplier to find out how you can ensure that your computer meets safety and regulatory requirements.

Cautions

Electrostatic discharge (ESD) can damage system components. Do the described procedures only at an ESD workstation. If no such station is available, you can provide some ESD protection by wearing an antistatic wrist strap and attaching it to a metal part of the computer chassis.

Safety Information

Before installing and using the device, note the following precautions:

- Read all instructions carefully.
- Do not place the unit on an unstable surface, cart, or stand.
- Follow all warnings and cautions in this manual.
- When replacing parts, ensure that your service technician uses parts specified by the manufacturer.
- Avoid using the system near water, in direct sunlight, or near a heating device.
- The load of the system unit does not solely rely for support from the rackmounts located on the sides. Firm support from the bottom is highly necessary in order to provide balance stability.
- The computer is provided with a battery-powered real-time clock circuit. There is a danger of explosion if battery is incorrectly replaced. Replace only with the same or equivalent type recommended by the manufacturer. Discard used batteries according to the manufacturer's instructions.

Installation Recommendations

Ensure you have a stable, clean working environment. Dust and dirt can get into components and cause a malfunction. Use containers to keep small components separated.

Adequate lighting and proper tools can prevent you from accidentally damaging the internal components. Most of the procedures that follow require only a few simple tools, including the following:

- A Philips screwdriver
- A flat-tipped screwdriver
- A grounding strap
- An anti-static pad

Using your fingers can disconnect most of the connections. It is recommended that you do not use needle-nose pliers to disconnect connections as these can damage the soft metal or plastic parts of the connectors.

Safety Precautions

1. Read these safety instructions carefully.
2. Keep this User Manual for later reference.
3. Disconnect this equipment from any AC outlet before cleaning. Use a damp cloth. Do not use liquid or spray detergents for cleaning.
4. For plug-in equipment, the power outlet socket must be located near the equipment and must be easily accessible.
5. Keep this equipment away from humidity.
6. Put this equipment on a stable surface during installation. Dropping it or letting it fall may cause damage.
7. The openings on the enclosure are for air convection to protect the equipment from overheating. **DO NOT COVER THE OPENINGS.**
8. Make sure the voltage of the power source is correct before connecting the equipment to the power outlet.
9. Place the power cord in a way so that people will not step on it. Do not place anything on top of the power cord. Use a power cord that has been approved for use with the product and that it matches the voltage and current marked on the product's electrical range label. The voltage and current rating of the cord must be greater than the voltage and current rating marked on the product.
10. All cautions and warnings on the equipment should be noted.
11. If the equipment is not used for a long time, disconnect it from the power source to avoid damage by transient overvoltage.
12. Never pour any liquid into an opening. This may cause fire or electrical shock.
13. Never open the equipment. For safety reasons, the equipment should be opened only by qualified service personnel.
14. If one of the following situations arises, get the equipment checked by service personnel:
 - a. The power cord or plug is damaged.
 - b. Liquid has penetrated into the equipment.
 - c. The equipment has been exposed to moisture.
 - d. The equipment does not work well, or you cannot get it to work according to the user's manual.
 - e. The equipment has been dropped and damaged.
 - f. The equipment has obvious signs of breakage.
15. Do not place heavy objects on the equipment.
16. The unit uses a three-wire ground cable which is equipped with a third pin to ground the unit and prevent electric shock. Do not defeat the purpose of this pin. If your outlet does not support this kind of plug, contact your electrician to replace your obsolete outlet.
17. **CAUTION: DANGER OF EXPLOSION IF BATTERY IS INCORRECTLY REPLACED. REPLACE ONLY WITH THE SAME OR EQUIVALENT TYPE RECOMMENDED BY THE MANUFACTURER. DISCARD USED BATTERIES ACCORDING TO THE MANUFACTURER'S INSTRUCTIONS.**

Technical Support and Assistance

1. For the most updated information of NEXCOM products, visit NEXCOM's website at www.nexcom.com.
2. For technical issues that require contacting our technical support team or sales representative, please have the following information ready before calling:
 - Product name and serial number
 - Detailed information of the peripheral devices
 - Detailed information of the installed software (operating system, version, application software, etc.)
 - A complete description of the problem
 - The exact wordings of the error messages

Warning!

1. Handling the unit: carry the unit with both hands and handle it with care.
2. Maintenance: to keep the unit clean, use only approved cleaning products or clean with a dry cloth.
3. CFast: Turn off the unit's power before inserting or removing a CFast storage card.

Conventions Used in this Manual



Warning:

Information about certain situations, which if not observed, can cause personal injury. This will prevent injury to yourself when performing a task.



Caution:

Information to avoid damaging components or losing data.



Note:

Provides additional information to complete a task easily.

Global Service Contact Information

Headquarters

NEXCOM International Co., Ltd.

9F, No. 920, Zhongzheng Rd.,
Zhonghe District, New Taipei City, 23586,
Taiwan, R.O.C.
Tel: +886-2-8226-7786
Fax: +886-2-8226-7782
www.nexcom.com

Asia

Taiwan

NexAIoT Headquarters

Industry 4.0 and Cloud Services

13F, No.922, Zhongzheng Rd.,
Zhonghe District, New Taipei City,
23586, Taiwan, R.O.C.
Tel: +886-2-8226-7796
Fax: +886-2-8226-7926
Email: jacobhuang@nexaiot.com
www.nexaiot.com

NexAIoT Co., Ltd.

Taichung Office

16F, No.250, Sec.2, Chongde Rd.,
Beitun District,
Taichung City, 406, Taiwan, R.O.C.
Tel: +886-4-2249-1179
Fax: +886-4-2249-1172
Email: jacobhuang@nexaiot.com
www.nexaiot.com

NexCOBOT Taiwan Co., Ltd.

13F, No.916, Zhongzheng Rd.,
Zhonghe District,
New Taipei City, 23586, Taiwan, R.O.C.
Tel: +886-2-8226-7786
Fax: +886-2-8226-7926
Email: jennyshern@nexcobot.com
www.nexcobot.com

GreenBase Technology Corp.

13F, No.922, Zhongzheng Rd.,
Zhonghe District,
New Taipei City, 23586, Taiwan, R.O.C.
Tel: +886-2-8226-7786
Fax: +886-2-8226-7900
Email: vivianlin@nexcom.com.tw
www.nexcom.com.tw

DivioTec Inc.

19F-1A, No.97, Sec.4, ChongXin Rd.,
Sanhong District,
New Taipei City, 24161, Taiwan, R.O.C.
Tel: +886-2-8976-3077
Email: sales@diviotec.com
www.diviotec.com

AIoT Cloud Corp.

13F, No.922, Zhongzheng Rd.,
Zhonghe District,
New Taipei City, 23586, Taiwan, R.O.C.
Tel: +886-2-8226-7786
Fax: +886-2-8226-7782
Email: alantsai@aiotcloud.net
www.aiotcloud.dev

EMBUX TECHNOLOGY CO., LTD.

13F, No.916, Zhongzheng Rd.,
Zhonghe District,
New Taipei City, 23586, Taiwan, R.O.C.
Tel: +886-2-8226-7786
Fax: +886-2-8226-7782
Email: info@embux.com
www.embux.com

TMR TECHNOLOGIES CO., LTD.

13F, No.916, Zhongzheng Rd.,
Zhonghe District,
New Taipei City, 23586, Taiwan, R.O.C.
Tel: +886-2-8226-7786
Fax: +886-2-8226-7782
Email: services@tmrtek.com
www.tmrtek.com

China NEXSEC Incorporated

201, Floor 2, Unit 2, Building 15, Yard 3,
Gaolizhang Road, Haidian District,
Beijing, 100094, China
Tel: +86-10-5704-2680
Fax: +86-10-5704-2681
Email: marketing@nexsec.cn
www.nexsec.cn

NEXCOM Shanghai

Room 406-407, Building C, No 154, Lane 953,
Jianchuan Road, Minhang District,
Shanghai, 201108, China
Tel: +86-21-5278-5868
Fax: +86-21-3251-6358
Email: sales@nexcom.cn
www.nexcom.cn

NEXCOM Surveillance Technology Corp.

Floor 8, Building B3, Xiufeng Industrial Zone,
GanKeng Community, Buji Street,
LongGang District,
ShenZhen, 518112, China
Tel: +86-755-8364-7768
Fax: +86-755-8364-7738
Email: steveyang@nexcom.com.tw
www.nexcom.cn

NEXGOL Chongqing

1st Building No.999,
Star Boulevard, Yongchuan Dist,
Chongqing City, 402160, China
Tel: +86-23-4960-9080
Fax: +86-23-4966-5855
Email: sales@nexgol.com.cn
www.nexcobot.cn

Beijing NexGemo Technology Co.,Ltd.

Room 205, No.1, Fazhan Road.,
Beijing International Information Industry Base,
Changping District,
Beijing, 102206, China
Tel: +86-10-8072-2025
Fax: +86-10-8072-2022
Email: sales@nexgemo.cn
www.nexgemo.com

Japan

NEXCOM Japan

9F, Tamachi Hara Bldg.,
4-11-5, Shiba Minato-ku,
Tokyo, 108-0014, Japan
Tel: +81-3-5419-7830
Fax: +81-3-5419-7832
Email: sales@nexcom-jp.com
www.nexcom-jp.com

America

USA NEXCOM USA

46665 Fremont Blvd.,
Fremont CA 94538, USA
Tel: +1-510-656-2248
Fax: +1-510-656-2158
Email: sales@nexcom.com
www.nexcomusa.com

Europe

United Kingdom NEXCOM EUROPE

10 Vincent Avenue,
Crownhill Business Centre,
Milton Keynes, Buckinghamshire
MK8 0AB, United Kingdom
Tel: +44-1908-267121
Fax: +44-1908-262042
Email: sales.uk@nexcom.eu
www.nexcom.com

Package Contents

Before continuing, verify that the VTC1020/VTC1020-PA/nROK1020 package that you received is complete. Your package should have all the items listed in the following table.

VTC1020

Item	Part Number	Name	Description	Qty
1	6012200052X00	PE Zipper Bag #8	PE Zipper Bag #8 170x240mm,W/China RoHS Symbol	1
2	6012200053X00	PE Zipper Bag #3	PE Zipper Bag #3 100x70mm,W/China RoHS Symbol	1
3	4NCPM00302X00	(T)Terminal Blocks 3P Phoenix Contact:1777992	(T)Terminal Blocks 3P Phoenix Contact:1777992 5.08mm Male DIP Green	1
4	50333P0027X00	Washer For SMA CONN KANGYANG:TW-181	Washer For SMA CONN KANGYANG:TW-181 13x1.8mm Nylon 66 Natural	2
5	50333P0028X00	Washer For SMA CONN KANGYANG:WS6-0.8(B)	Washer For SMA CONN KANGYANG:WS6-0.8(B) 12.8x6.4x0.8mm PC Black	2
6	602DCD1427X00	VTC1020 Series DVD Driver Ver:1.0	VTC1020 SERIES DVD Driver VER:1.0 JCL	1
7	602DCD1512X00	VTC1020/nROK1020 Series DVD Driver Ver:1.1	VTC1020/nROK1020 Series DVD Driver VER:1.1 JCL	1
8	603POW0234X00	Power Cable 8Pin To 6Pin 12V DC OUT SUNJET:SLNEX822910	Power Cable 8Pin To 6Pin 12V DC OUT SUNJET:SLNEX822910 ATX 2x4 PIT:3.0mm TO ATX 2x3 PIT:4.2mm UL1007 22AWG L=200mm	1
9	50311F0100X00	(H)Round Head Screw W/Spring+Flat Washer Long Fei:P3x6L	(H)Round Head Screw W/Spring+Flat Washer Long Fei:P3x6L P3x6 iso/SW6x0.5 NI	4
10	603ANT0115X00	GPS/GLONASS Antenna Unictron:SM-76G	GPS/GLONASS Antenna Unictron:SM-76G SMA Male L=5000mm	1
11	6030000225X00	Composite Cable For VTC1020 ST:MD-5105158	Composite Cable FOR VTC1020 ST:MD-5105158 DB15 TO DB9x3 L:300mm	1
12	6030000226X00	Multi Cable FOR VTC1020 ST:MD-5105157	Multi Cable For VTC1020 ST:MD-5105157 DB15 TO DB9x6 L:300mm	1

Package Contents

VTC1020-PA

Item	Part Number	Name	Description	Qty
1	6012200052X00	PE Zipper Bag #8	PE Zipper Bag #8 170x240mm,W/China RoHS Symbol	1
2	6012200053X00	PE Zipper Bag #3	PE Zipper Bag #3 100x70mm,W/China RoHS Symbol	1
3	4NCPM00302X00	(T)Terminal Blocks 3P Phoenix Contact:1777992	(T)Terminal Blocks 3P Phoenix Contact:1777992 5.08mm Male DIP Green	1
4	50333P0027X00	Washer For SMA CONN KANGYANG:TW-181	Washer For SMA CONN KANGYANG:TW-181 13x1.8mm Nylon 66 Natural	2
5	50333P0028X00	Washer For SMA CONN KANGYANG:WS6-0.8(B)	Washer For SMA CONN KANGYANG:WS6-0.8(B) 12.8x6.4x0.8mm PC Black	2
6	602DCD1427X00	VTC 1020 Series DVD Driver Ver:1.0	VTC1020 SERIES DVD Driver VER:1.0 JCL	1
7	602DCD1512X00	VTC 1020/nROK1020 Series DVD Driver Ver:1.1	VTC1020/nROK1020 Series DVD Driver VER:1.1 JCL	1
8	603POW0234X00	Power Cable 8Pin To 6Pin 12V DC OUT SUNJET:SLNEX822910	Power Cable 8Pin To 6Pin 12V DC OUT SUNJET:SLNEX822910 ATX 2x4 PIT:3.0mm TO ATX 2x3 PIT:4.2mm UL1007 22AWG L=200mm	1
9	50311F0100X00	(H)Round Head Screw W/Spring+Flat Washer Long Fei:P3x6L	(H)Round Head Screw W/Spring+Flat Washer Long Fei:P3x6L P3x6 iso/SW6x0.5 NI	4
10	603ANT0115X00	GPS/GLONASS Antenna Unictron:SM-76G	GPS/GLONASS Antenna Unictron:SM-76G SMA Male L=5000mm	1
11	6030000225X00	Composite Cable For VTC 1020 ST:MD-5105158	Composite Cable FOR VTC 1020 ST:MD-5105158 DB15 TO DB9x3 L:300mm	1
12	6030000226X00	Multi Cable FOR VTC 1020 ST:MD-5105157	Multi Cable For VTC 1020 ST:MD-5105157 DB15 TO DB9x6 L:300mm	1

Package Contents

nROK1020

Item	Part Number	Name	Description	Qty
1	6012200052X00	PE Zipper Bag #8	PE Zipper Bag #8 170x240mm,W/China RoHS Symbol	1
2	6012200053X00	PE Zipper Bag #3	PE Zipper Bag #3 100x70mm,W/China RoHS Symbol	1
3	50333P0027X00	Washer For SMA CONN KANGYANG:TW-181	Washer For SMA CONN KANGYANG:TW-181 13x1.8mm Nylon 66 Natural	2
4	50333P0028X00	Washer For SMA CONN KANGYANG:WS6- 0.8(B)	Washer For SMA CONN KANGYANG:WS6-0.8(B) 12.8x6.4x0.8mm PC Black	2
5	602DCD1427X00	VTC 1020 Series DVD Driver Ver:1.0	VTC 1020 Series DVD Driver Ver:1.0 JCL	1
6	603POW0234X00	Power Cable 8Pin To 6Pin 12V DC OUT SUNJET:SLNEX822910	Power Cable 8Pin To 6Pin 12V DC OUT SUNJET:SLNEX822910 ATX 2x4 PIT:3.0mm TO ATX 2x3 PIT:4.2mm UL1007 22AWG L=200mm	1
7	50311F0100X00	(H)Round Head Screw W/Spring+Flat Washer Long Fei:P3x6L	VTC 1020/nROK1020 Series DVD Driver Ver:1.1 JCL	4
8	603ANT0115X00	GPS/GLONASS Antenna Unictron:SM-76G	GPS/GLONASS Antenna Unictron:SM-76G SMA Male L=5000mm	1
9	92V00102001X0	Power Cable To Coil ABS Molding For nROK1020 ST:ST-1904006	Power Cable To Coil ABS Molding For nROK1020 ST:ST-1904006 Waterproof 4P To Wire L=300mm With VIOB-PWRAD-01	1

Ordering Information

The following information below provides ordering information for the VTC 1020 and nROK 1020 series.

VTC 1020 (P/N: 10V00102001X0)

Intel® Atom™ x5-E3930 processor 1.8GHz with 4GB DDR3L, U-blox GPS module, GPS antenna and CAN 2.0B

VTC 1020-PA (P/N: 10V00102000X0)

Intel® Atom™ x5-E3930 processor 1.8GHz with 4GB DDR3L, U-blox GPS module, GPS antenna and CAN 2.0B, LVDS and 1 x Audio-in + 3 x Audio-out

nROK 1020-A (P/N: 10V00102002X0)

Intel® Atom™ x5-E3930 processor 1.8GHz with 4GB DDR3L, U-blox GPS module, GPS antenna, EN50155 Class OT4 (24VDC w/o isolation)

CHAPTER 1: PRODUCT INTRODUCTION

Physical Features

VTC 1020 Front View

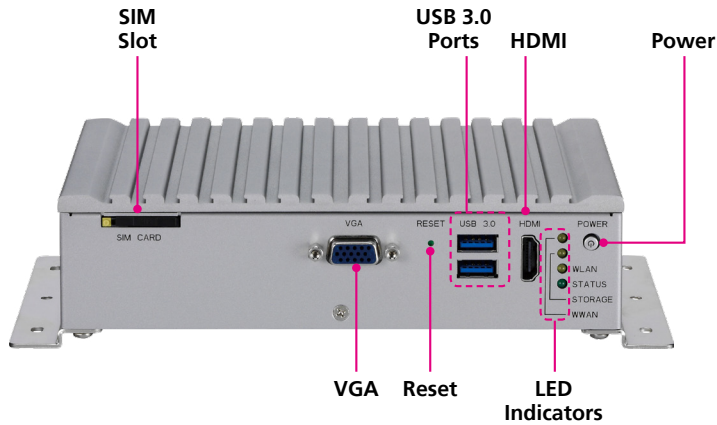

VTC 1020 Rear View

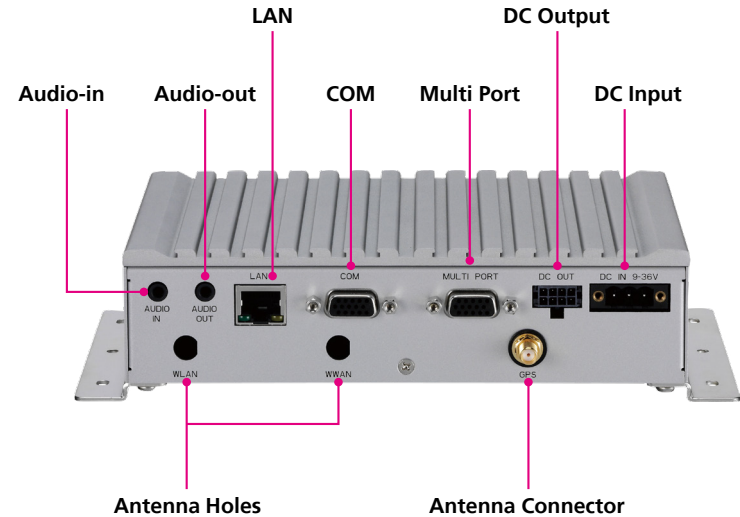

Physical Features

VTC 1020-PA Front View

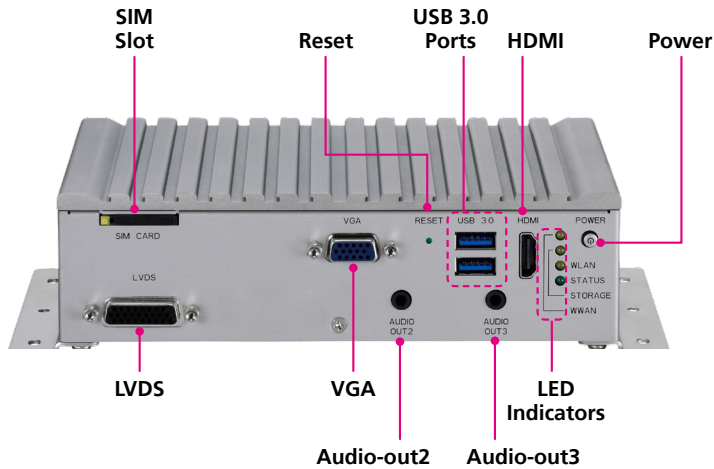

VTC 1020-PA Rear View

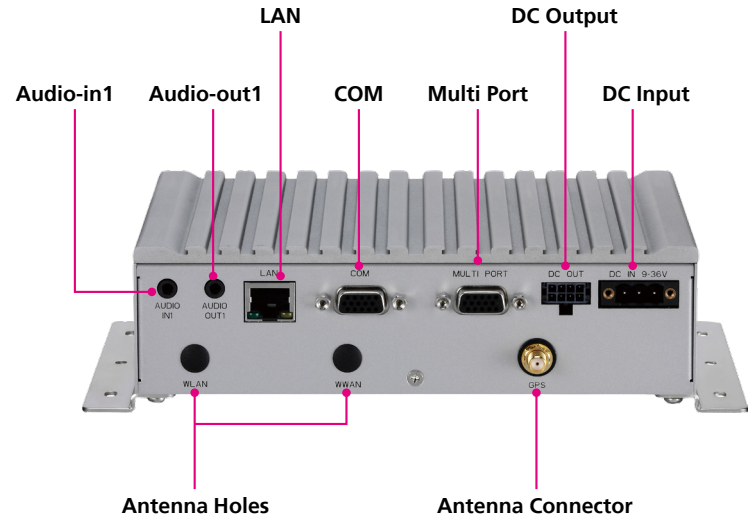

Physical Features

nROK 1020 Front View

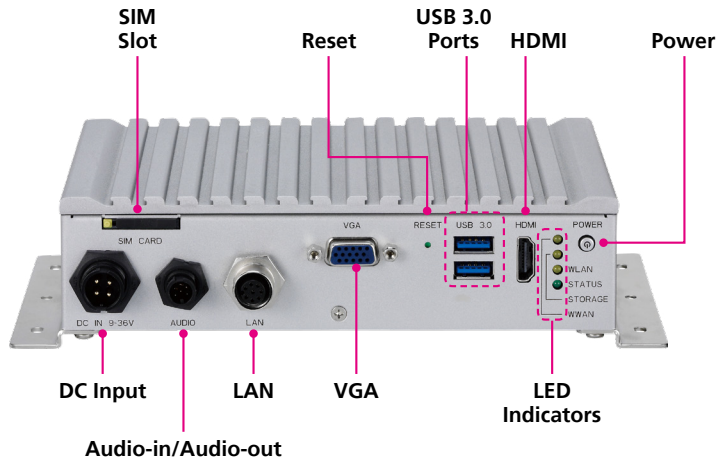

nROK 1020 Rear View

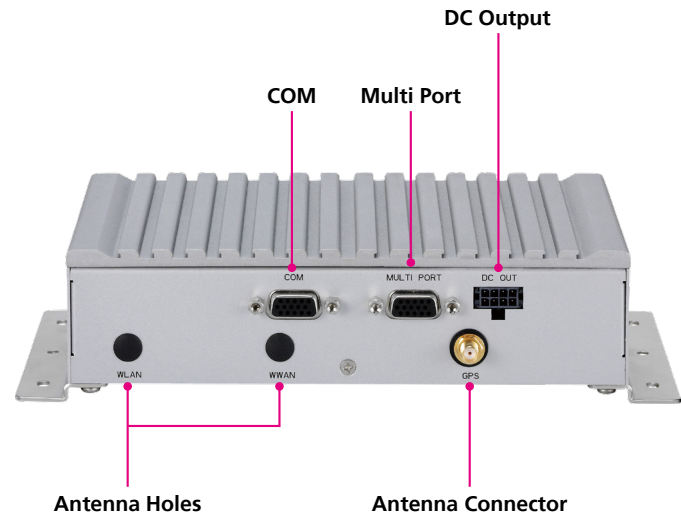

VTC 1020 Overview

VTC 1020, a compact, rugged and entry-level vehicle computer with Intel® Atom™ x5-E3930 processor dual core 1.8GHz, is designed for the harsh in-vehicle environment. Because of the compact design, it is especially for the vehicles with limited space to locate the computer system, but without compromising with its space to sacrifice its features.

VTC 1020 has onboard CAN 2.0B and optional OBD interface (SAE J1939) for vehicle diagnostics and driver behavior management. An advanced GPS receiver supports GPS/Gloness/QZSS/Galileo/Beidou and optional dead reckoning module is also available. VTC 1020 features WLAN and WWAN wireless data and voice connectivity. With external SIM socket, it allows user to access SIM card conveniently. 12VDC output can be provided for external display with easy power wire arrangement. VTC 1020 keeps the flexibility to meet different demands for telematics applications, such as infotainment, fleet management and patching system.

VTC 1020 Key Features

- Compact and fanless design
- Built-in GPS receiver with optional dead reckoning function
- Variety of wireless communication options
- Built-in CAN bus 2.0B. Optional CAN/SAE J1939/J1708 function
- Wide range DC input from 9~36V
- Smart power management with Ignition on/off delay via software control and low voltage protection
- Certified by CE/FCC/E13 mark
- 5 x RS232 and 2 x RS485

VTC 1020-PA Overview

VTC 1020-PA, a compact, rugged and entry-level vehicle computer with Intel® Atom™ x5-E3930 processor dual core 1.8GHz, is dedicated for public transportation application in harsh in-vehicle environment. Because of the compact design, it is especially for the vehicles with limited space to locate the computer system, but without compromising with its space to sacrifice its features.

VTC 1020-PA has 1 Audio-in and 3 Audio-out switchable that can be used as public announcement function, such as for driver, internal passengers and external passengers. Since it has 3 independent video output, it is flexible to provide different video content in PIS application. VTC 1020-PA has on board CAN 2.0B and optional CAN/SAE J1939/J1708 for vehicle diagnostics and driver behavior management. An advanced GPS receiver supports GPS/Glonass/QZSS/Galileo/Beidou and optional dead reckoning module is also available. VTC 1020-PA features WLAN and WWAN wireless data and voice connectivity. With external SIM socket, it allows user to access SIM card conveniently. 12VDC output can be provided for external display with easy power wire arrangement. VTC 1020-PA is very suitable for public transportation application, such as local bus, shuttle bus, tour bus and highway bus.

VTC 1020-PA Key Features

- Compact and fanless design
- Built-in GPS receiver with optional dead reckoning function
- Variety of wireless communication options
- Built-in CAN bus 2.0B. Optional CAN/SAE J1939/J1708 function
- Smart power management with Ignition on/off delay via software control and low voltage protection
- Wide range DC input from 9~36V
- Certified by CE/FCC/E13 mark
- 5 x RS232 and 2 x RS485
- 1 x Audio-in and 3 x Audio-out switchable
- 3 x Independent video output (VGA + HDMI + LVDS) simultaneously

nROK 1020 Overview

nROK 1020, a compact, rugged and entry-level railway computer with Intel® Atom™ x5-E3930 processor dual core 1.8GHz, is designed for the harsh railway related applications. Because of the compact design, it is easy to be located without compromising its features.

Adopting lock concept, LAN, Power-in and Audio, are all designed against vibration and shock impact. An advanced GPS receiver supports GPS/Gloness/QZSS/Galileo/Beidou. Thanks to 2 mini-PCIe socket, nROK 1020 is perfectly suited for wireless applications, such as WLAN and WWAN data and voice transmission. With external SIM socket, it allows users to access SIM card conveniently. 12VDC output can be provided for external display with easy power wire arrangement. nROK 1020 is very suitable for Passenger Information System, Automatic Fare Collections and digital radio data/voice transmission applications.

nROK 1020 Key Features

- Compact and fanless design
- Built-in GPS receiver
- Variety of wireless communication options
- Smart power management with Ignition on/off delay via software control and low voltage protection
- 24VDC EN50155 Class OT4 conformity
- 5 x RS232 and 2 x RS485

Hardware Specifications

VTC 1020

CPU

- Intel® Atom™ x5-E3930 processor dual core 1.8GHz

Memory

- 1x 204-pin DDR3L SO-DIMM socket support 1867MHz up to 8GB.
Default 4GB

Expansion

- 1x mini-PCIe socket (USB)
- 1x mini-PCIe socket (PCIe + USB + mSATA)

Function

- 1x u-blox NEO-M8N module (support GPS/Gloness/QZSS/Galileo/Beidou) or optional module with Dead Reckoning
- Built-in G-sensor
- Built-in TPM

I/O Interface-Front

- 1x power button
- 4x LED indicators for Status, Storage, WLAN and WWAN
- 1x system reset button
- 2x type A USB 3.0 compliant host, supporting system boot up
- 1x DB-15 VGA
- 1x HDMI
- 1x external SIM card socket

I/O Interface-Rear

- 1x 9~36VDC input with Ignition and 20W typical power consumption

- 1x 12V/2A DC output, SMBus, power button
- 1x RJ45 with LEDs for 10/100/1000Mbps Ethernet
- 1x Audio-in, 1x Audio-out
- 1x DB9 COM port for 4x RS232 Tx/Rx and 2x RS485
- 1x DB15 for multi port
 - 1x CAN2.0 (BOM optional SAE J1939)
 - 1x RS232 Tx/Rx
 - 1x odometer and direction for optional DR
 - 5x programmable DIO
 - Input voltage (sink type): 5VDC TTL (default)
 - Input voltage (source type): 3~24VDC
 - Digital output (sink type): 5VDC TTL (default), max current: 20mA
 - Digital output (source type): 3~24VDC
- 3x Antenna holes for SMA-type antenna (WWAN/WLAN/GPS)

Expandable Storage

- 1x 2.5" SSD SATA 3.0
- 1x mSATA

Operating System

- Windows 10
- Linux YOCTO (by request)

Power Management

- Selectable boot-up & shut-down voltage for low power protection
- HW design ready for 8-level delay time on/off at user's self configuration
- Power on/off ignition, software detectable
- Support S3, S4 suspend mode

Dimensions & Weight

- 185mm (W) x 120mm (D) x 45mm (H) (7.3" x 4.7" x 1.8")
- 1kg (2.20lbs)

Construction

- Aluminum top case with sheet metal

Environment

- -40°C to 70°C (w/ industrial SSD) with air flow
- Storage temperatures: -40°C to 85°C
- Relative humidity: 10% to 90% (non-condensing)
- Vibration (SSD):
 - Vibration (random): 2g @5~500 Hz
 - Operating: MIL-STD-810F, Method 514.5, Category 20, Ground Vehicle – Highway Truck
 - Storage: MIL-STD-810F, Method 514.5, Category 24, Integrity Test
- Shock (SSD):
 - Operating: MIL-STD-810F, Method 516.5, Procedure I, Trucks and semi-trailers=20g
 - Crash hazard: MIL-STD-810F, Method 516.5, Procedure V, Ground equipment=75g

Standards/Certifications

- CE approval
- FCC Class A
- E13 mark

VTC 1020-PA

CPU

- Intel® Atom™ x5-E3930 processor dual core 1.8GHz

Memory

- 1x 204-pin DDR3L SO-DIMM socket support 1867MHz up to 8GB. Default 4GB

Expansion

- 1x mini-PCIe socket (USB)
- 1x mini-PCIe socket (PCIe + USB + mSATA)

Function

- 1x u-blox NEO-M8N module (support GPS/Gloness/QZSS/Galileo/Beidou) or optional module with Dead Reckoning
- Built-in G-sensor
- Built-in TPM

I/O Interface-Front

- 1x power button
- 4x LED indicators for Status, Storage, WLAN and WWAN
- 1x system reset button
- 2x type A USB 3.0 compliant host, supporting system boot up
- 1x DB-15 VGA
- 1x HDMI
- 1x external SIM card socket
- 1x DB26 LVDS interface with 12VDC, USB 2.0 and power button
- 2x Audio-out

I/O Interface-Rear

- 1x 9~36VDC input with Ignition and 20W typical power consumption

- 1x 12V/2A DC output, SMBus, power button
- 1x RJ45 with LEDs for 10/100/1000Mbps Ethernet
- 1x Audio-in, 1x Audio-out
- 1x DB15 COM port for 4x RS232 Tx/Rx and 2x RS485
- 1x DB15 for multi port
 - 1x CAN2.0 (BOM optional SAE J1939)
 - 1x RS232 Tx/Rx
 - 1x odometer and direction for optional GPS DR
 - 5x programmable DIO
 - Input voltage (sink type): 5VDC TTL (default)
 - Input voltage (source type): 3~24VDC
 - Digital output (sink type): 5VDC TTL (default), max current: 20mA
 - Digital output (source type): 3~24VDC
- 3x Antenna holes for SMA-type antenna (WWAN/WLAN/GPS)

Expandable Storage

- 1x 2.5" SSD SATA 3.0
- 1x mSATA

Operating System

- Windows 10
- Linux YOCTO (by request)

Power Management

- Selectable boot-up & shut-down voltage for low power protection
- HW design ready for 8-level delay time on/off at user's self configuration
- Power on/off ignition, software detectable
- Support S3, S4 suspend mode

Dimensions & Weight

- 185mm (W) x 120mm (D) x 50mm (H) (7.3" x 4.7" x 1.96")
- 1.1kg (2.42lbs)

Construction

- Aluminum top case with sheet metal

Environment

- -40°C to 70°C (w/ industrial SSD) with air flow
- Storage temperatures: -40°C to 85°C
- Relative humidity: 10% to 90% (non-condensing)
- Vibration (SSD):
 - Vibration (random): 2g @5~500 Hz
 - Operating: MIL-STD-810F, Method 514.5, Category 20, Ground Vehicle – Highway Truck
 - Storage: MIL-STD-810F, Method 514.5, Category 24, Integrity Test
- Shock (SSD):
 - Operating: MIL-STD-810F, Method 516.5, Procedure I, Trucks and semi-trailers=20g
 - Crash hazard: MIL-STD-810F, Method 516.5, Procedure V, Ground equipment=75g

Standards/Certifications

- CE approval
- FCC Class A
- E13 mark

nROK 1020

CPU

- Intel® Atom™ x5-E3930 processor dual core 1.8GHz

Memory

- 1x 204-pin DDR3L SO-DIMM socket support 1867MHz up to 8GB. Default 4GB

Expansion

- 1x Full size mini-PCIe socket (USB 2.0) for LTE module with 1 x external SIM
- 1x Full size mini-PCIe socket (PCIe 2.0, USB 2.0, mSATA)

Function

- 1x u-blox NEO-M8N module (support GPS/Gloness/QZSS/Galileo/Beidou)
- Built-in G-sensor
- Built-in TPM

I/O Interface-Front

- 1x power button
- 4x LED indicators for Status, Storage, WLAN and WWAN
- 1x system reset button
- 2x type A USB 3.0 compliant host, supporting system boot up
- 1x DB-15 VGA
- 1x HDMI
- 1x external SIM card socket
- 1x circular connector for 9~36VDC input with ignition and 20W typical power consumption
- 1x circular connector for Audio-In and Audio-Out
- 1x M12 connector for 10/100/1000Mbps Ethernet

I/O Interface-Rear

- 1x 12V/2A DC output, SMBus, power button
- 1x DB15 COM port for 4x RS232 Tx/Rx and 2x RS485
- 1x DB15 for multi port
 - 1x CAN2.0
 - 1x RS232 Tx/Rx
 - 1x odometer and direction
 - 5x programmable DIOInput voltage (sink type): 5VDC TTL (default)
Input voltage (source type): 3~24VDC
Digital output (sink type): 5VDC TTL (default), max current: 20mA
Digital output (source type): 3~24VDC
- 3x Antenna holes for SMA-type antenna (WWAN/WLAN/GPS)

Expandable Storage

- 1x 2.5" SSD SATA 3.0
- 1x mSATA

Operating System

- Windows 10
- Linux YOCTO (by request)

Power Management

- Selectable boot-up & shut-down voltage for low power protection
- HW design ready for 8-level delay time on/off at user's self configuration
- Power on/off ignition, software detectable
- Support S3, S4 suspend mode

Dimensions & Weight

- 185mm (W) x 120mm (D) x 45mm (H) (7.3" x 4.7" x 1.8")
- 1kg (2.20lbs)

Construction

- Aluminum top case with sheet metal

Environment

- Operating temperatures: EN 50155, class OT4 -40 ~ 70°C, 85°C for 10
- Storage temperatures: -40°C to 85°C
- Relative humidity: 10% to 90% (non-condensing)
- Vibration:
 - Vibration (random): 2g @5~500 Hz
 - Operating: MIL-STD-810F, Method 514.5, Category 20, Ground Vehicle – Highway Truck
 - Storage: MIL-STD-810F, Method 514.5, Category 24, Integrity Test
- Shock:
 - Operating: MIL-STD-810F, Method 516.5, Procedure I, Trucks and semi-trailers=20g
 - Crash hazard: MIL-STD-810F, Method 516.5, Procedure V, Ground equipment=75g

Standards/Certifications

- CE
- FCC Class A
- EN 50155: 2017
 - Ambient temperature EN 50155, Class OT4 (-40~70°C), 85°C for 10 minutes
 - Interruptions of voltage supply class S1
 - Supply change over class C1, C2
 - EMC EN 50121-3-2: 2016
 - Environment EN 60068-2-1, EN 60068-2-2
 - Shock and vibration IEC 61373 Class B
 - Protective coating class PC1 (PC2, by request)
- EN 45545-2:2020 (PCB)

Mechanical Dimensions

VTC 1020

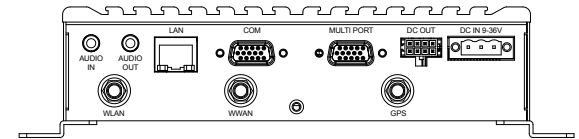
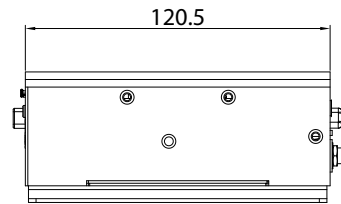
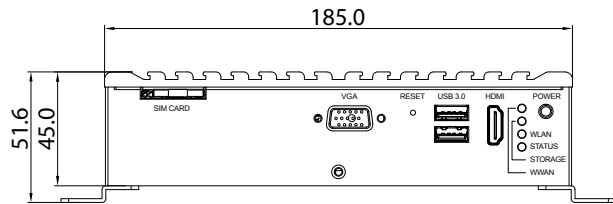
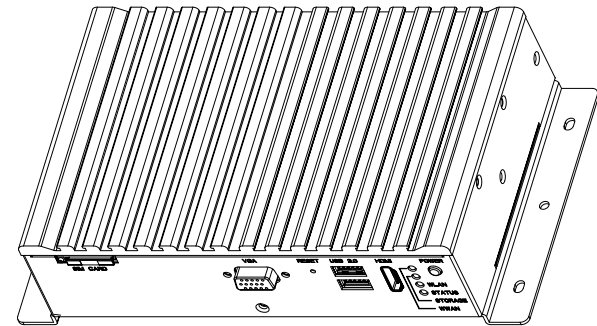
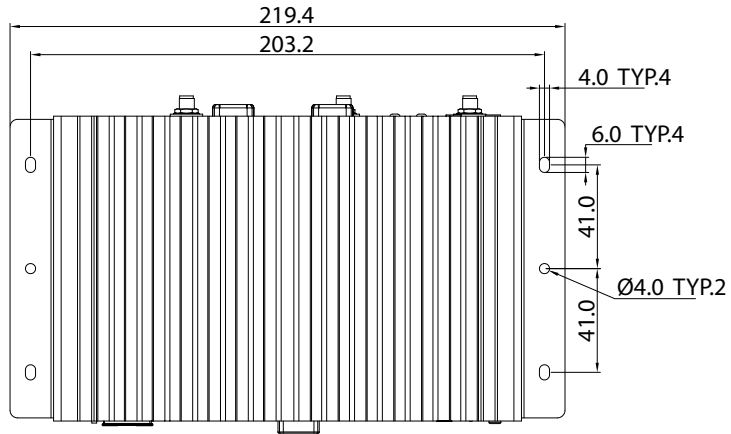

VTC 1020-PA

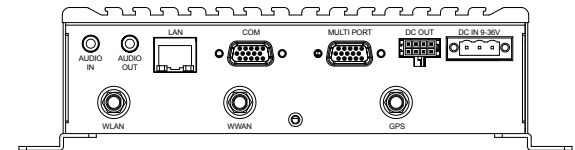
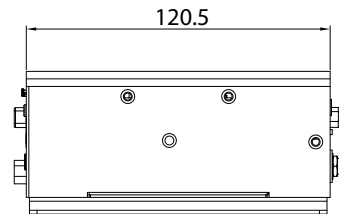
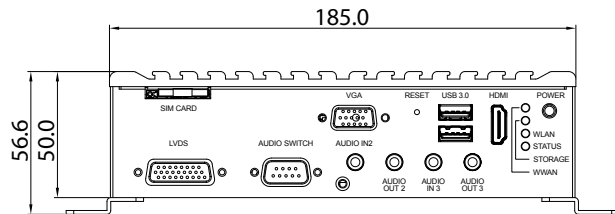
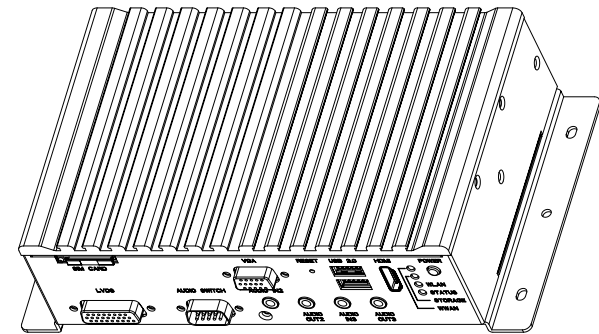
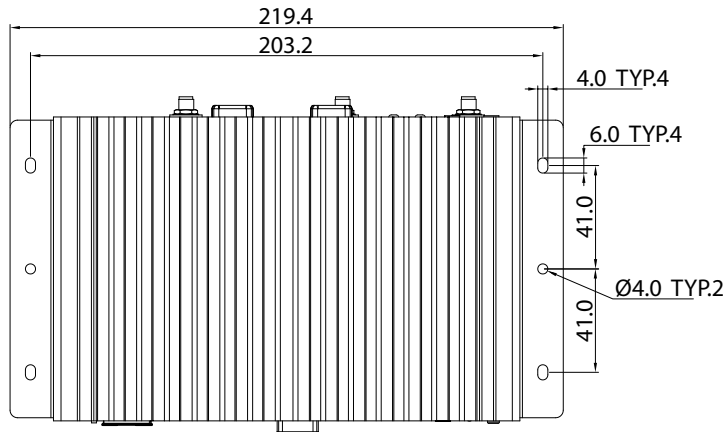

nROK 1020

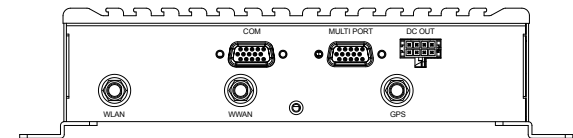
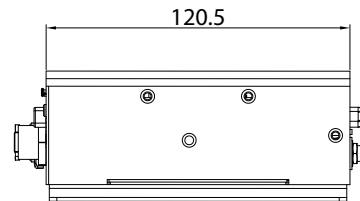
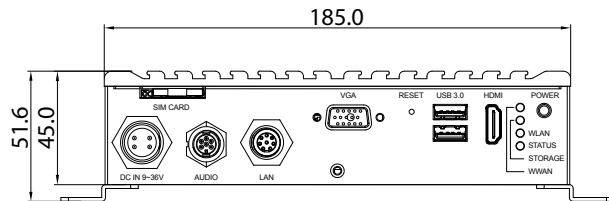
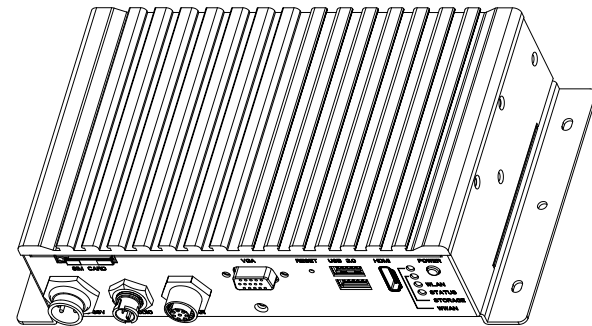
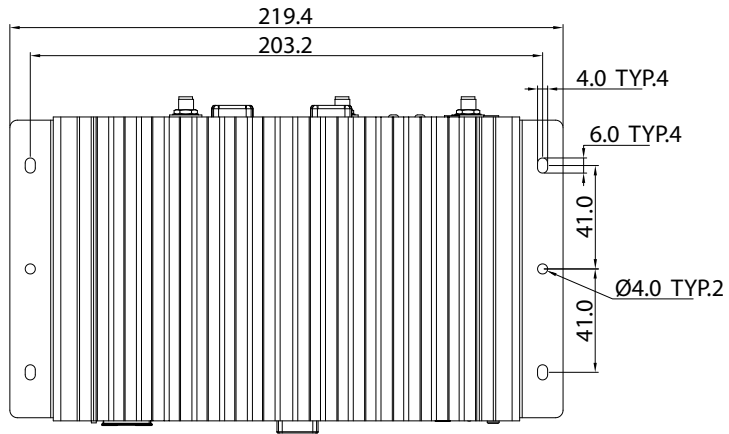

Connector Numbering

The following diagrams indicate the numbers of the connectors. Use these numbers to locate the connectors' respective pinout assignments on chapter 2 of the manual.

VTC 1020 Front View

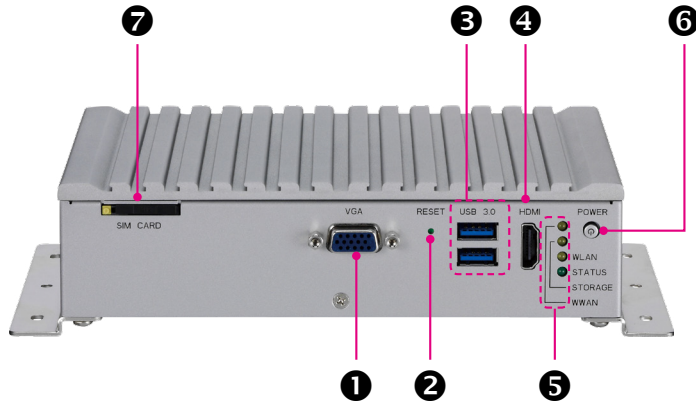

VTC 1020 Rear View

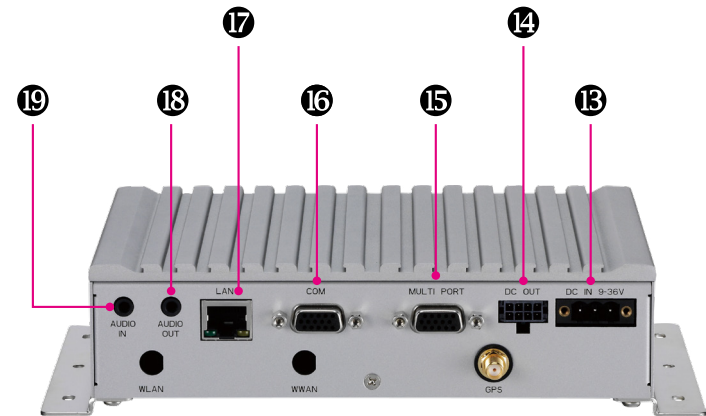

VTC 1020-PA Front View

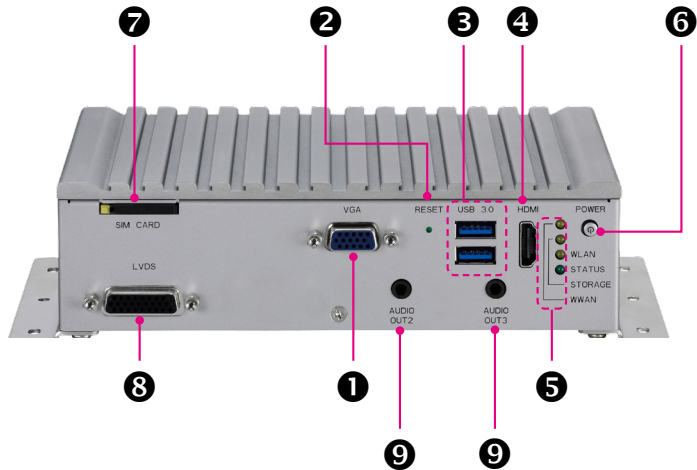

VTC 1020-PA Rear View

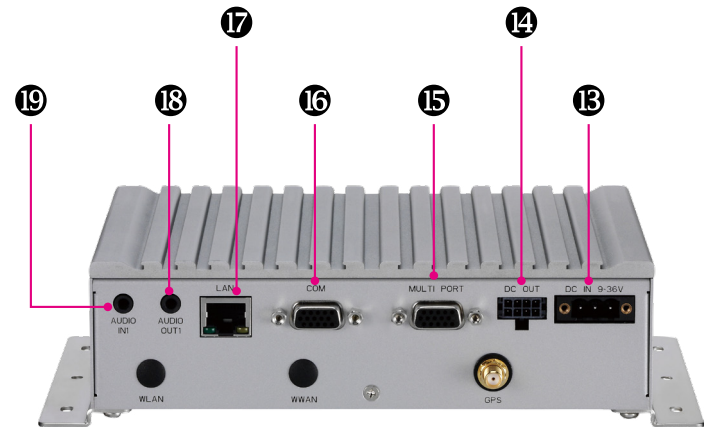

nROK 1020 Front View

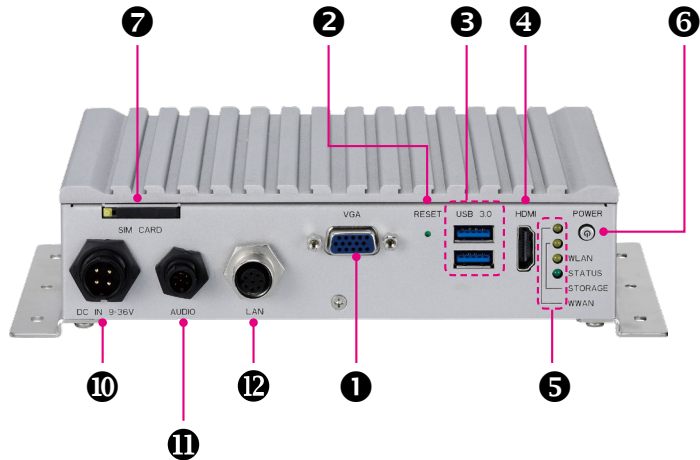

nROK 1020 Rear View

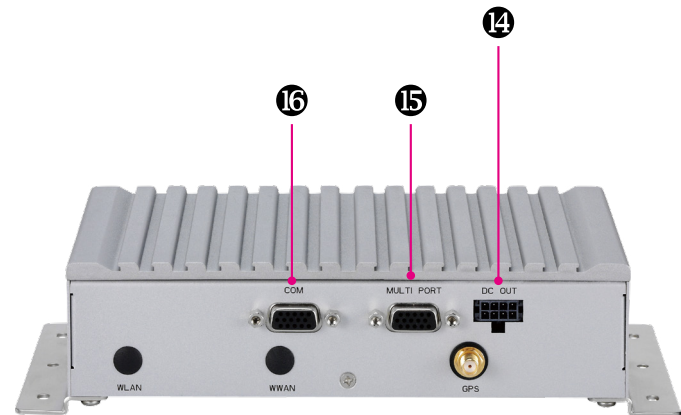

CHAPTER 2: EXTERNAL CONNECTORS PINOUT DESCRIPTION

VGA Connector

Connector number: 1

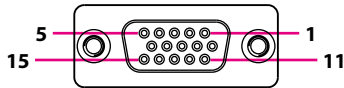

Pin	Definition	Pin	Definition
1	VGA_RED	2	VGA_GREEN
3	VGA_BLUE	4	CH7517_SPC_R
5	GND	6	GND
7	GND	8	GND
9	VGA_+5V	10	GND
11	CH7517_SPD_R	12	VGA_DATA
13	VGA_HS	14	VGA_VS
15	VGA_CLK		

Reset Switch

Connector Number: 2

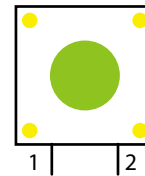

Press this button to restart the system.

Dual USB 3.0 Ports

Connector number: 3

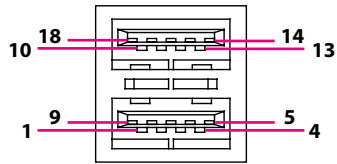

Pin	Definition	Pin	Definition
1	5V	2	USB_ON
3	USB_OP	4	GND
5	USB3_TX0_N	6	USB3_TX0_P
7	GND	8	USB3_RX0_N
9	USB3_RX0_P	10	5V
11	USB_1N	12	USB_1P
13	GND	14	USB3_TX1_N
15	USB3_TX1_P	16	GND
17	USB3_RX1_N	18	USB3_RX1_P

HDMI

Connector number: 4

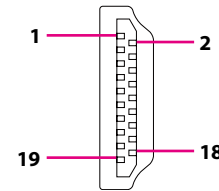

Pin	Definition	Pin	Definition
1	HDMI_TX2P_L	2	GND
3	HDMI_TX2N_L	4	HDMI_TX1P_L
5	GND	6	HDMI_TX1N_L
7	HDMI_TX0P_L	8	GND
9	HDMI_TX0N_L	10	HDMI_CLK_P_L
11	GND	12	HDMI_CLK_N_L
13	NC	14	NC
15	HDMI_SCL	16	HDMI_SDA
17	GND	18	HDMI_P5V
19	HDMI_HPD		

LED Indicators

Connector number: 5

 **WWAN**

 **Storage**

 **WLAN**

 **Status**

LED	Description
WWAN	Blinking: Active
Storage	Light On: HDD/SSD Active
WLAN	Blinking: Active
Status	Power On: Green

Power Button

Connector number: 6



1 x R/B Bi-color LED	
LED Status	Description
Off	Power off
Blue	Power good
Red	Power fail

When the ignition is from “low” to “high”, the system will turn on automatically. When the ignition is “high”, press the power button to turn on/off the system.

When the ignition is from “high” to “low”, the system will turn off automatically. When the ignition is “low”, pressing the power button will not turn on the system.

Mini-SIM Card Slot

Connector number: 7

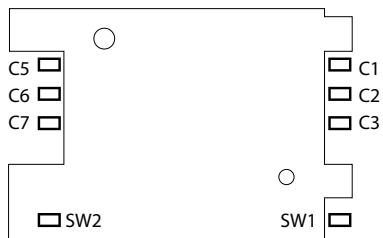

Pin	Definition	Pin	Definition
C1	UIM_PWR	C2	UIM_RST
C3	UIM_CLK	C5	GND
C6	NC	C7	UIM_DATA
SW1	SIM2_DET#	SW2	GND

LVDS Connector (VTC 1020-PA)

Connector number: 8

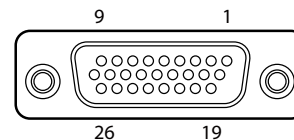

Pin	Definition	Pin	Definition
1	Panel_EN	2	Panel_control
3	VDD	4	VDD
5	LCDD09(OUT3)	6	LCDD01(OUT0)
7	LCDD08(OUT3#)	8	LCDD00(OUT0#)
9	LCDD_GND	10	LCDD_GND
11	LCDD07(CLK)	12	LCDD03(OUT1)
13	LCDD06(CLK#)	14	LCDD02(OUT1#)
15	LVDS_GND	16	LCDD_GND
17	LCDD05(OUT2)	18	Power on push button
19	LCDD04(OUT2#)	20	Panel_backlight
21	LCDD_GND	22	Panel-Gnd
23	USB_0#	24	Contact_DET#
25	USB_0	26	USB_VCC

Front Audio-Out 2 & 3 Connectors (VTC 1020-PA)

Connector number: 9



Pin	Definition	Pin	Definition
1	Right channel	2	Jack detect
3	NC	4	Left channel
5	GND	6	GND

DC Power Input (nROK 1020)

Connector number: 10

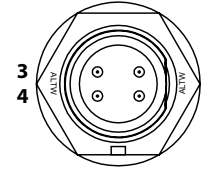

Pin	Definition	Pin	Definition
1	POWER (+)	2	GND (-)
3	IGNITION (I)	4	NC

Audio Connector (nROK 1020)

Connector number: 11

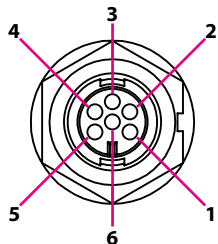

Pin	Definition	Pin	Definition
1	SURR_OUT_L_CA	2	SURR_JD
3	SURR_OUT_R_CA	4	MIC-IN
5	MIC_JD	6	C_GND

M12 LAN Port (nROK 1020)

Connector number: 12

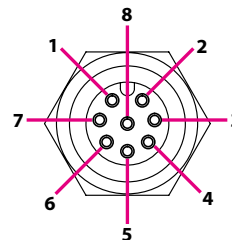

Pin	Definition	Pin	Definition
1	LAN_MDI_0P_R	2	LAN_MDI_0N_R
3	LAN_MDI_1P_R	4	LAN_MDI_1N_R
5	LAN_MDI_2P_R	6	LAN_MDI_2N_R
7	LAN_MDI_3P_R	8	LAN_MDI_3N_R

DC Power Input

Connector number: 13

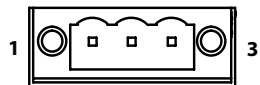

Pin	Definition
1	GND_IN
2	V_IN
3	IGNITION

12V DC Output

Connector number: 14

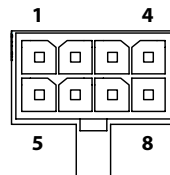

Pin	Definition	Pin	Definition
1	NC	2	NC
3	GND	4	GND
5	BAT_DAT	6	BAT_CLK
7	Push button input	8	+V12S

Multi Port Connector

Connector number: 15

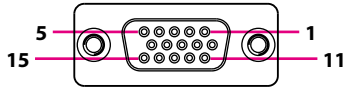

Pin	Definition	Pin	Definition
1	DIRECTION	2	RXD3_R
3	GPIO1	4	GPIO4
5	GND	6	1PPS
7	TXD3_R	8	CAN1_L
9	GPIO3	10	GND
11	ODOMETER	12	CAN1_H
13	GPIO2	14	GPIO5
15	GND		

COM Connector

Connector number: 16

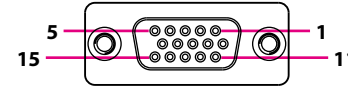

Pin	Definition	Pin	Definition
1	RXD_R_D	2	TXD2_R
3	RXD1_R	4	RS485B_-
5	GND	6	TXD_R_D
7	TXD_R_B	8	TXD1_R
9	RS485A_+	10	GND
11	RXD_R_D	12	RXD2_R
13	RS485A_-	14	RS485B_+
15	GND		

LAN Port

Connector number: 17

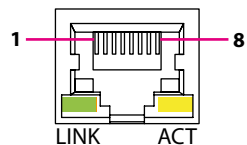

Pin	Definition	Pin	Definition
1	MDI0P	2	MDI0N
3	MDI1P	4	MDI2P
5	MDI2N	6	MDI1N
7	MDI3P	8	MDI3N
9	LED2-	10	LED2+
11	LED1-	12	LED1+

Rear Audio-Out 1 Connector

Connector number: 18



Pin	Definition	Pin	Definition
1	Right channel	2	Jack detect
3	NC	4	Left channel
5	GND	6	GND

Rear Audio-In 1 Connector

Connector number: 19



Pin	Definition	Pin	Definition
1	Right channel	2	Jack detect
3	NC	4	NC
5	GND	6	GND



Note: Stereo microphone supported only

CHAPTER 3: JUMPERS AND CONNECTORS

This chapter describes how to set the jumpers and connectors on the VTC 1020 and nROK 1020 series motherboard.

Before You Begin

- Ensure you have a stable, clean working environment. Dust and dirt can get into components and cause a malfunction. Use containers to keep small components separated.
- Adequate lighting and proper tools can prevent you from accidentally damaging the internal components. Most of the procedures that follow require only a few simple tools, including the following:
 - A Philips screwdriver
 - A flat-tipped screwdriver
 - A set of jewelers screwdrivers
 - A grounding strap
 - An anti-static pad
- Using your fingers can disconnect most of the connections. It is recommended that you do not use needle-nosed pliers to disconnect connections as these can damage the soft metal or plastic parts of the connectors.
- Before working on internal components, make sure that the power is off. Ground yourself before touching any internal components, by touching a metal object. Static electricity can damage many of the electronic components. Humid environments tend to have less static electricity than

dry environments. A grounding strap is warranted whenever danger of static electricity exists.

Precautions

Computer components and electronic circuit boards can be damaged by discharges of static electricity. Working on computers that are still connected to a power supply can be extremely dangerous.

Follow the guidelines below to avoid damage to your computer or yourself:

- Always disconnect the unit from the power outlet whenever you are working inside the case.
- If possible, wear a grounded wrist strap when you are working inside the computer case. Alternatively, discharge any static electricity by touching the bare metal chassis of the unit case, or the bare metal body of any other grounded appliance.
- Hold electronic circuit boards by the edges only. Do not touch the components on the board unless it is necessary to do so. Don't flex or stress the circuit board.
- Leave all components inside the static-proof packaging that they shipped with until they are ready for installation.
- Use correct screws and do not over tighten screws.

Jumper Settings

A jumper is the simplest kind of electric switch. It consists of two metal pins and a cap. When setting the jumpers, ensure that the jumper caps are placed on the correct pins. When the jumper cap is placed on both pins, the jumper is short. If you remove the jumper cap, or place the jumper cap on just one pin, the jumper is open.

Refer to the illustrations below for examples of what the 2-pin and 3-pin jumpers look like when they are short (on) and open (off).

Two-Pin Jumpers: Open (Left) and Short (Right)

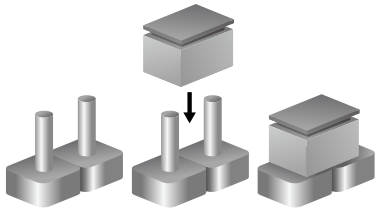

Three-Pin Jumpers: Pins 1 and 2 are Short

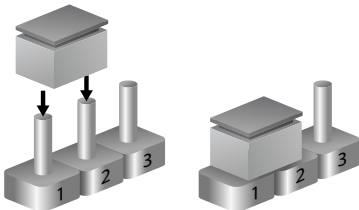

Locations of the Jumpers and Connectors

This chapter lists the location and pinout assignment of the jumpers and connectors on the VTC 1020 and nROK 1020 series motherboard.

Top View

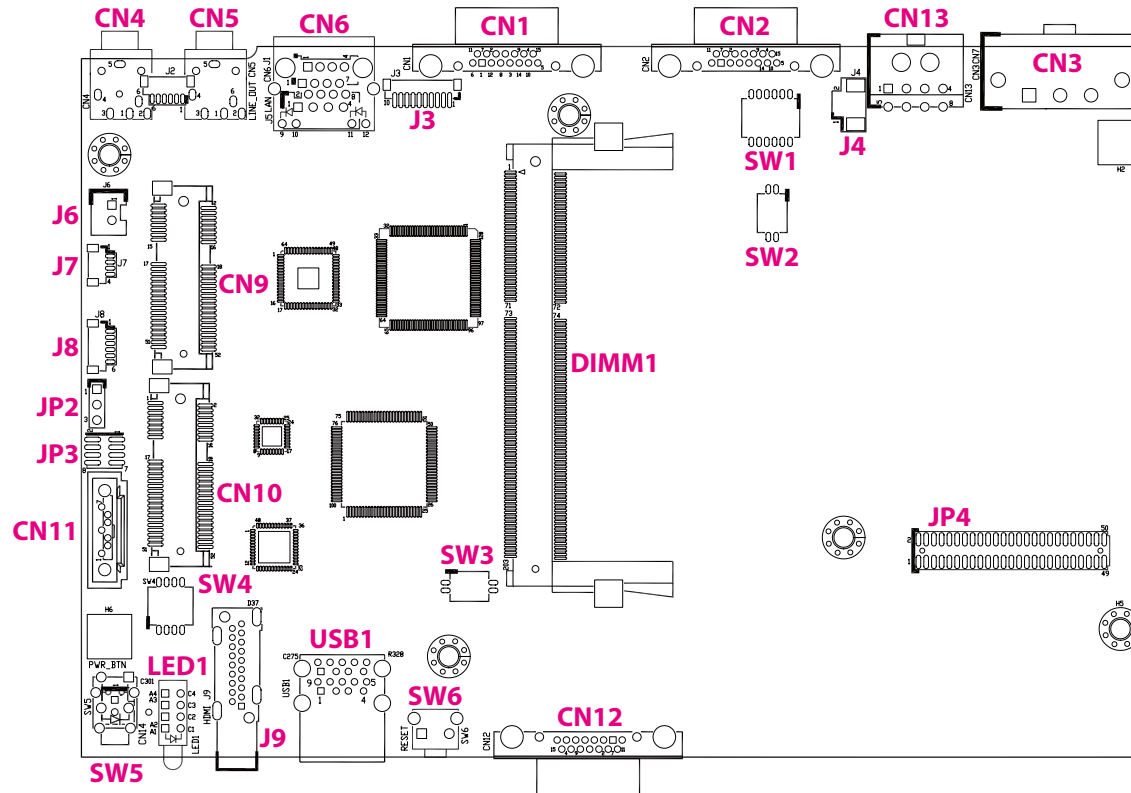

Bottom View

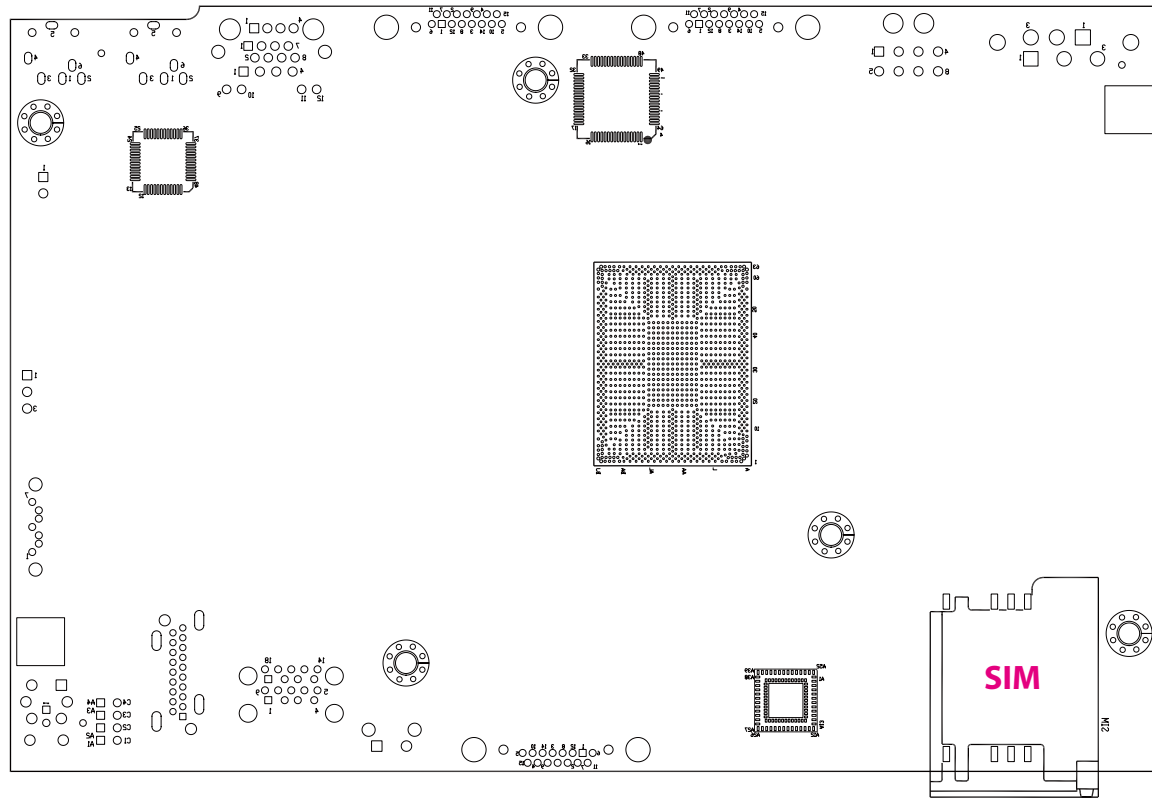

Connector Pin Definitions

CMOS Clear Switch

Connector type: DIP switch

Connector location: SW2

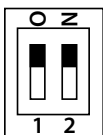

Function	Definition
Clear CMOS/ME	1-2 ON
Normal	*1-2 OFF

(*) Default

GPIO Pull High Switch

Connector type: DIP switch

Connector location: SW1

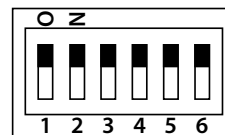

SW	On (Default)	Off
SW1.1	Pull up VCC5	Don't care
SW1.2	Pull up VCC5	Don't care
SW1.3	Pull up VCC5	Don't care
SW1.4	Pull up VCC5	Don't care
SW1.5	Pull up VCC5	Don't care
SW1.6	Enable terminal resistor	Disable terminal resistor

WWAN/WLAN Module Selector

Connector location: SW4

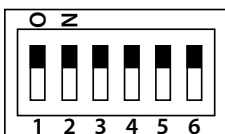

For WWAN Wake-Up & Voice Functions on Mini-PCle CN10			
	WWAN HE910/LE910 Wake-Up & Voice*	WWAN SIM5360E Wake-Up & Voice	WWAN MC7304/MC7354 Wake-Up & Voice
SW4.1	On	Off	Off
SW4.2	Off	On	On
SW4.3	Off	On	On
SW4.4	On	Off	Off
Digital Voice**	HE910 (I2S)	PCM	MC73xx(PCM)

*Default Settings

**Digital voice is selectable in BIOS.

For WLAN LED on Mini-PCle CN9		
	WLAN (LED Low Active) CE902A, DPE909- AA*	WLAN (LED High Active) ZQ802XRACB, Q802XRN6F
SW4.5	On	Off
SW4.6	Off	On

*Default Settings

Input Voltage Control Switch

Connector type: DIP switch

Connector location: SW3

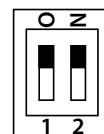

Function	Definition
12V	1 Off, 2 Off
24V	1 Off, 2 On
9~36V (Default)	*1 On, 2 On

*Default Settings

RTC Battery Connector

Connector type: 1x2 2-pin header, 1.25mm pitch

Connector location: J4

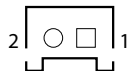

Pin	Definition
1	GND
2	VBAT1

Debug 80 Port Connector

Connector type: 1x10 10-pin header, 1.0mm pitch

Connector location: J3

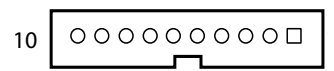

Pin	Definition	Pin	Definition
1	GND	2	PCIRST#
3	33M_CLK	4	LPC_FRAME#
5	LPC_AD3	6	LPC_AD2
7	LPC_AD1	8	LPC_AD0
9	VCC3	10	VCC3

SATA Power Connector

Connector type: 1x2 2-pin header, 2.5mm pitch

Connector location: J6

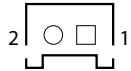

Pin	Definition
1	VCC5
2	GND

SATA Connector

Connector type: Standard Serial ATA 7P (1.27mm, SATA-M-180)

Connector location: CN11

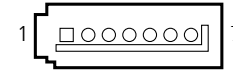

Pin	Definition	Pin	Definition
1	GND	2	SATA_TXP0
3	SATA_TXN0	4	GND
5	SATA_RXN0	6	SATA_RXP0
7	GND		

MCU Debug Port

Connector type: 1x3 3-pin header, 2.54mm pitch

Connector location: JP2

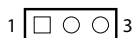

Pin	Definition
1	DEBUG_TX
2	DEBUG_RX
3	GND

MCU Download Port

Connector type: 2x4 8-pin header, 1.27mm pitch

Connector location: JP3

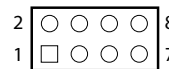

Pin	Definition	Pin	Definition
1	V3.3ALW	2	MCU_RST
3	MCU_TRST	4	MCU_TDI
5	MCU_TCK	6	MCU_TMS
7	MCU_TDO	8	GND

GPS Connector

Connector type: 1x6 6-pin header, 1.0mm pitch

Connector location: J8



Pin	Definition	Pin	Definition
1	GPS_BAT	2	GPS_LED
3	CTX	4	CRX
5	GND	6	VCC3_GPS

GPS DR Connector

Connector type: 1x4 4-pin header, 1.0mm pitch

Connector location: J7



Pin	Definition	Pin	Definition
1	GND	2	1PPS
3	ODOMETER	4	DIRECTION

Full Size Mini-PCIe Socket (PCIe 2.0, USB 2.0, mSATA)

Connector location: CN9

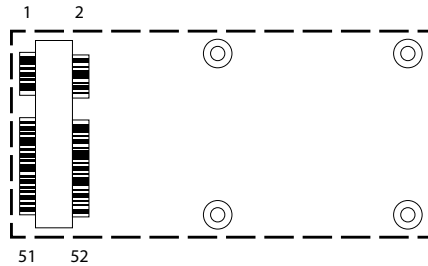

Pin	Definition	Pin	Definition
1	WAKE#	2	+V3.3_MINI_3
3	NC	4	GND
5	NC	6	+V1.5S_MINI_3
7	CLKREQ	8	NC
9	GND	10	NC
11	REFCLK-	12	NC
13	REFCLK+	14	NC
15	GND	16	NC
17	NC	18	GND
19	NC	20	MINICARD3_DIS#
21	GND	22	WLAN_RESET#
23	SATA_RXPO_C	24	+V3.3_MINI_3
25	SATA_RXNO_C	26	GND

Pin	Definition	Pin	Definition
27	GND	28	+V1.5S_MINI_3
29	GND	30	SMBCLK
31	SATA_TXNO_C	32	SMBDAT
33	SATA_TXPO_C	34	GND
35	GND	36	USB_D-
37	GND	38	USB_D+
39	+V3.3_MINI_3	40	GND
41	+V3.3_MINI_3	42	WWAN_LED#
43	GND	44	NC
45	NC	46	NC
47	NC	48	+V1.5S_MINI_3
49	NC	50	GND
51	CTRL0	52	+V3.3_MINI_3

Full Size Mini-PCIe Socket (USB 2.0) for LTE Module with 1 x External SIM

Connector location: CN10

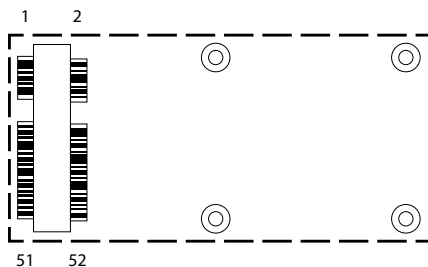

Pin	Definition	Pin	Definition
1	MINI_MIC_P	2	+V3.3A_MINI_4
3	MINI_MIC_N	4	GND
5	MINI_SPK_PRR	6	NC
7	U_GND	8	UIM_PWR2
9	GND	10	UIM_DAT2
11	VCC_MSM26_DIG	12	UIM_CLK2
13	NC	14	UIM_RST2
15	GND	16	NC
17	NC	18	GND
19	NC	20	3.5G_DIS#
21	GND	22	3.5G_RST#
23	NC	24	+V3.3A_MINI_4
25	NC	26	GND

Pin	Definition	Pin	Definition
27	GND	28	NC
29	GND	30	NC
31	NC	32	SMS_RI_3.5G_R
33	UMTS_RESET#_R	34	GND
35	GND	36	USB-
37	GND	38	USB+
39	+V3.3A_MINI_4	40	GND
41	+V3.3A_MINI_4	42	3.5G_LED#_R
43	GND	44	NC
45	PCM_CLK	46	NC
47	PCM_RX	48	NC
49	PCM_TX	50	GND
51	PCM_SYNC	52	+V3.3A_MINI_4

CHAPTER 4: SYSTEM SETUP

Opening the Enclosure



Prior to removing the chassis cover, make sure the unit's power is off and disconnected from the power sources to prevent electric shock or system damage.

1. Remove the screws on the bottom of the enclosure.

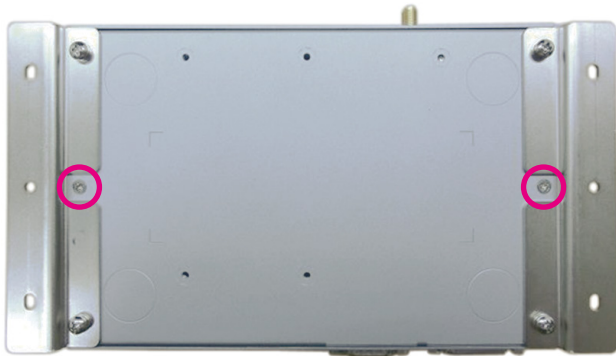

2. Remove the screw on the front panel.



3. Remove the screw on the rear panel.

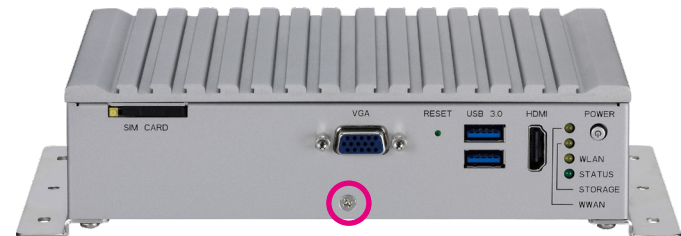

Installing a SO-DIMM

1. Push the ejector tabs which are at the ends of the socket outward. Then insert the module into the socket at an approximately 30 degrees angle. Apply firm even pressure to each end of the module until it slips down into the socket. The contact fingers on the edge of the module will almost completely disappear inside the socket.

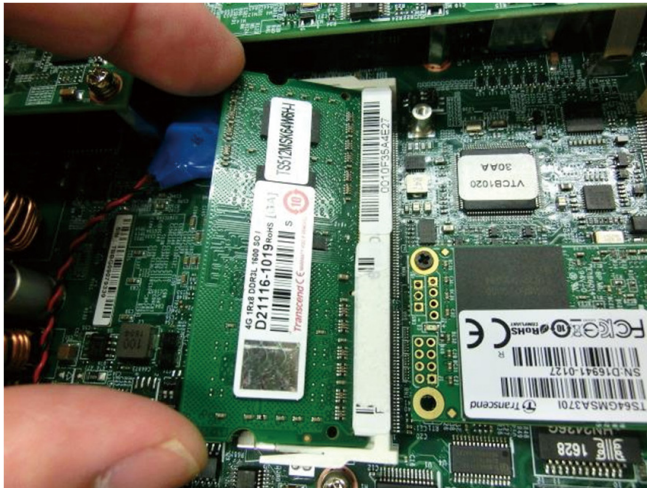

Installing the Wi-Fi Module

1. Locate the Mini PCI Express slot (CN9). Insert the Wi-Fi module into the Mini PCI Express slot at a 45 degrees angle until the gold-plated connector on the edge of the module completely disappears inside the slot. Then fasten screws into the mounting holes to secure the module.

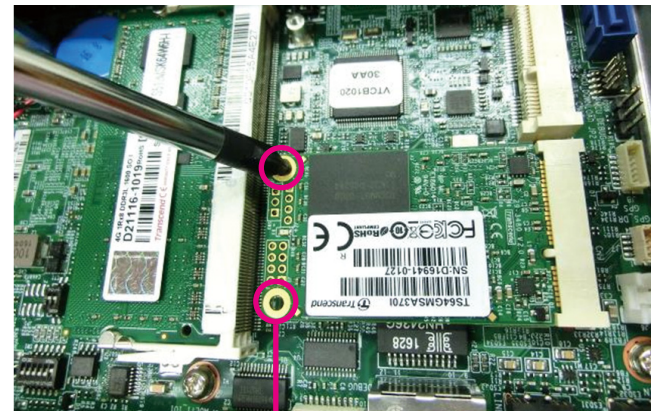

Mounting screws

Installing the WWAN Module

1. Locate the WWAN Mini PCI Express slot (CN10). Insert the module into the Mini PCI Express slot at a 45 degrees angle until the gold-plated connector on the edge of the module completely disappears inside the slot. Then fasten screws into the mounting holes to secure the module.



**Mounting
screws**

Installing a SSD/HDD Drive

1. Loosen the mounting screws on the hard drive bracket and remove it from the bottom cover.

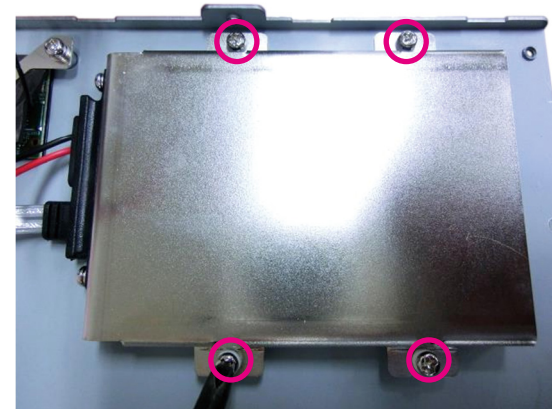

2. Insert the hard drive into the hard drive bracket. Align the hard drive's mounting holes with the mounting holes on the hard drive bracket, and use the provided screws to secure the hard drive in place.



Inserting the SIM Card

1. Press the yellow button on the SIM slot and take out the SIM tray on the front panel. Put the SIM card into the tray then insert it back to its original position.

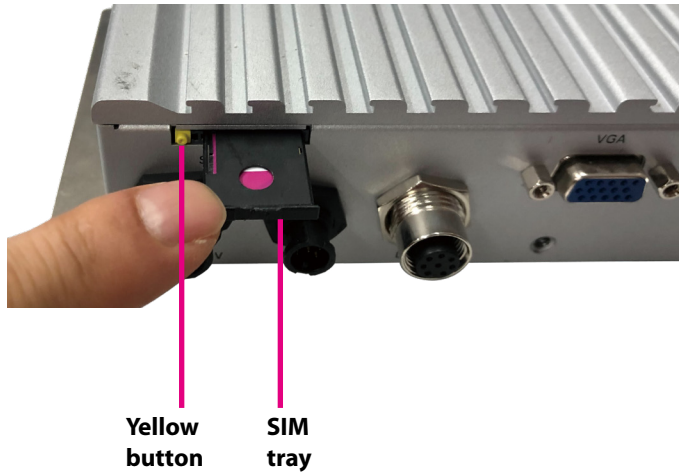

APPENDIX A: SOFTWARE DEMO UTILITY FOR I/O PORTS OF FUNCTION CONTROL

NEXCOM's software demo utility enables users to test and control different I/O port functions on the VTC 1020 and nROK 1020 series. This document shows how to use the utility.

There are also source code files of the utility in the CD. Users can refer to the source codes to develop their applications.

Menu Screen

Config1

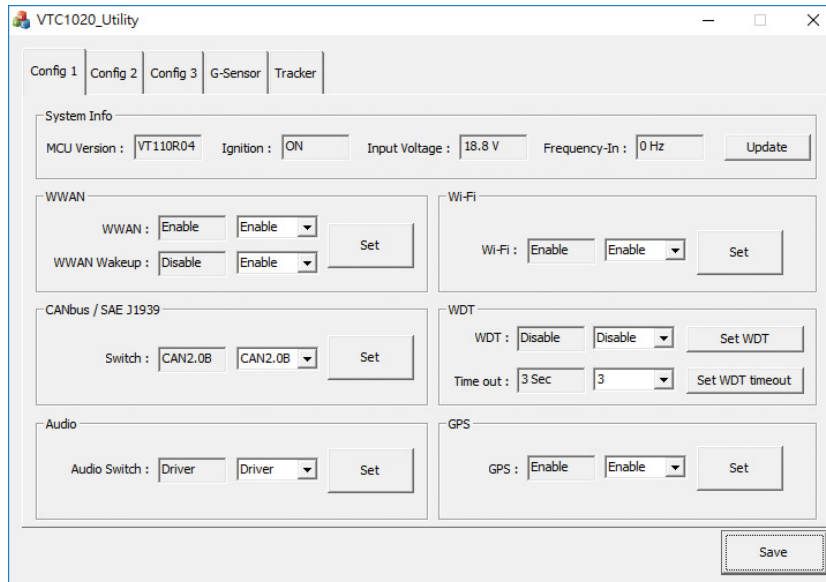

Config2

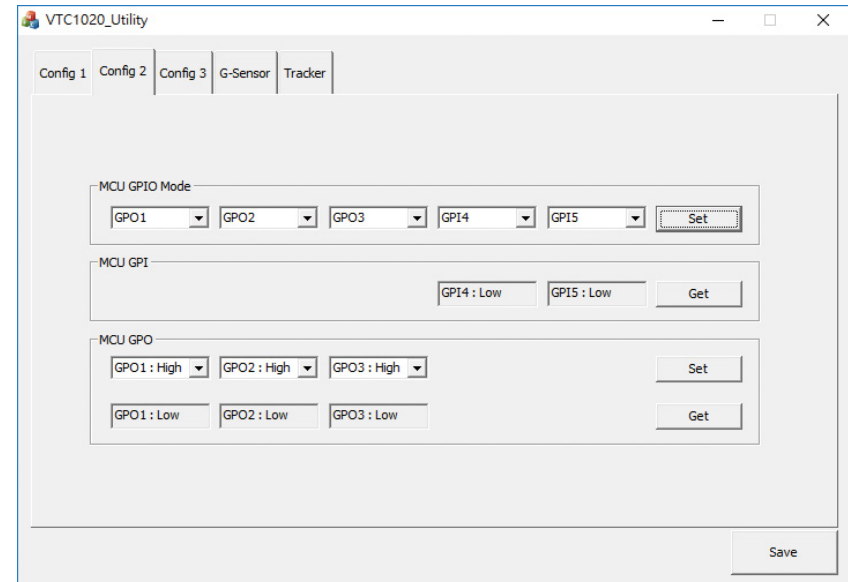

1. Config1

1.1 System Info

MCU Version: Shows the MCU Version.

Ignition: Shows the signal of ignition.

ON: Signal of ignition is high.

OFF: Signal of ignition is low.

Input Voltage: Shows the voltage level of power-in.

Frequency-In: Shows the frequency of speed pulse signal.

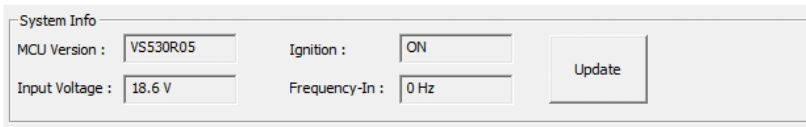

System Info

MCU Version :	VS530R05	Ignition :	ON	Update
Input Voltage :	18.6 V	Frequency-In :	0 Hz	

1.2 WWAN

Enables or disables the WWAN function on CN10 Mini-PCIe socket.

Enables or disables the WWAN wakeup function on CN10 Mini-PCIe socket.

The setting can also be cleared by the Set button.

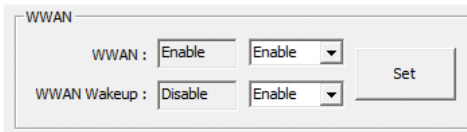

WWAN

WWAN : Enable Enable ▾ Set

WWAN Wakeup : Disable Enable ▾ Set

1.3 Wi-Fi

Enables or disables the Wi-Fi module function on CN9 Mini-PCIe socket.

The setting can also be cleared by the Set button.

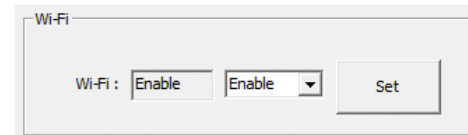

Wi-Fi

Wi-Fi : Enable Enable ▾ Set

1.4 CANbus/SAE J1939

Selects CAN Bus or SAE J1939 function. CAN Bus is default setting. If SAE J1939 is supported (BOM option), SAE J1939 has to be selected.

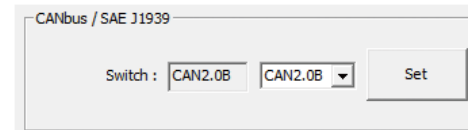

CANbus / SAE J1939

Switch : CAN2.0B CAN2.0B ▾ Set

1.5 WDT

Enables or disables the WDT function. There are several selections of time.

The timer of WDT can also be cleared by the Set WDT Timeout button.



WDT

WDT : Disable Disable ▾ Set WDT

Time out : 3 Sec 3 ▾ Set WDT timeout

1.6 Audio

This function is for VTC 1020-PA only.

The Audio-In signal can be connected with following Audio-Out: Audio-Out, Audio-Out2, Audio-Out3.

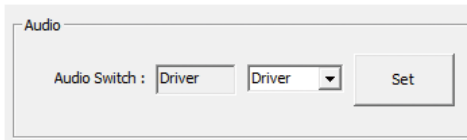

Audio

Audio Switch :

1.7 GPS

Enables or disables the GPS function.

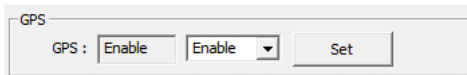

GPS

GPS :

2. Config2

2.1 MCU GPIO Mode

Defines GPIO port as GPO or GPI.

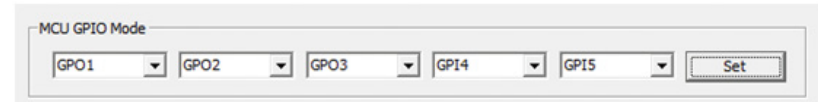

MCU GPIO Mode

2.2 MCU GPI

Reads the status of GPI.

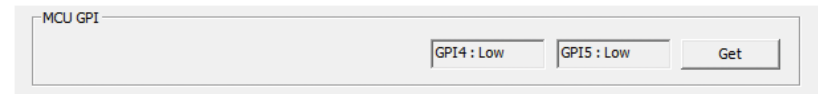

MCU GPI

2.3 MCU GPO

Selects the GPO ports and makes the output low or high.

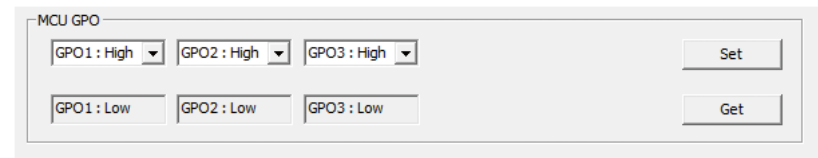

MCU GPO

3. Config3

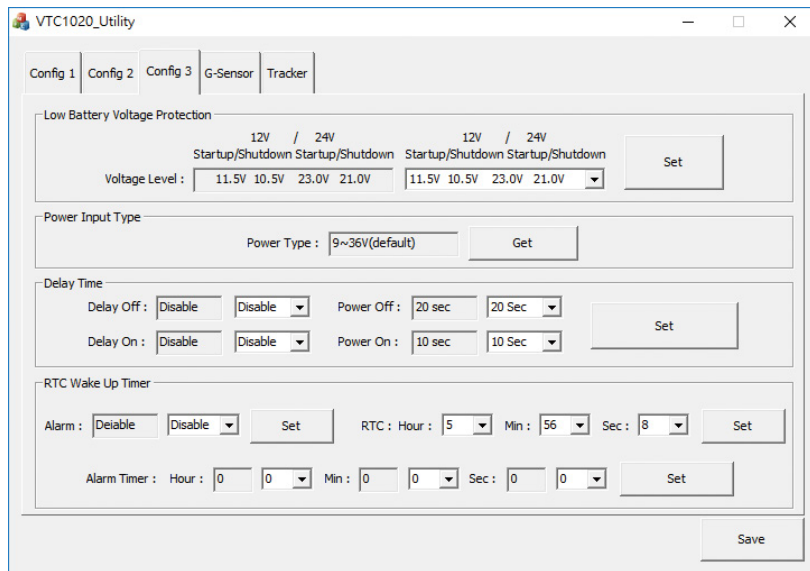

3.1 Low Battery Voltage Protection

Sets the Low Battery Voltage Protection Startup/Shutdown voltage level during 12V/24V.

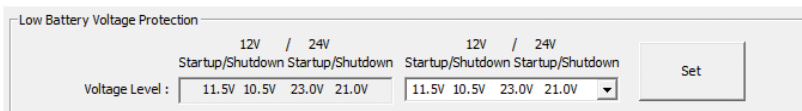

3.2 Power Input Type

Shows the setting of input voltage in SW1 DIP switch.

If the setting is 12V: 12V is shown.

If the setting is 24V: 24V is shown.

If the setting is 9V~36V: 9V~36V is shown.

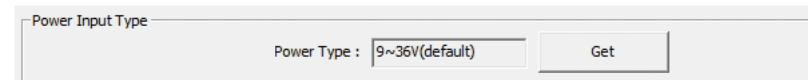

3.3 Delay Time

Enables or disables the delay time function. There are several selections of delay time.

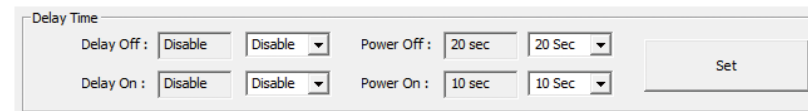

3.4 RTC Wake Up Timer

Enables or disables the RTC wake up function. The timer setting of RTC and Alarm Timer can be configured.

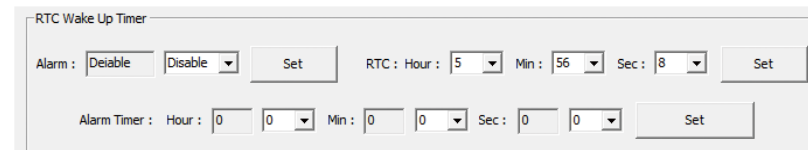

4. G-Sensor

The screenshot shows the VTC1020_Utility application window. It has tabs for Config 1, Config 2, Config 3, G-Sensor, and Tracker. The G-Sensor tab is active. At the top, there are buttons for 'Read G-Sensor Data' and 'Write G-Sensor Data', both with '0A' values. Below this, a dropdown menu shows 'G-Sensor Reg Index : 45 : POWER_CTL'. A table lists various registers with columns for Num, Name, Type, Value, and Description. A 'Refresh' button is on the right, and a 'Save' button is at the bottom right.

Num	Name	Type	Value	Description
0	DEVID	R	E5	Device ID
1~28	Reserved			Reserved; do not access
29	THRESH_TAP	R/W	00	Tap threshold
30	OFSX	R/W	00	X-axis offset
31	OFSY	R/W	00	Y-axis offset
32	OFSZ	R/W	00	Z-axis offset
33	DUR	R/W	00	Tap duration
34	Latent	R/W	00	Tap latency
35	Window	R/W	00	Tap window
36	THRESH_ACT	R/W	00	Activity threshold
37	THRESH_INACT	R/W	00	Inactivity threshold
38	TIME_INACT	R/W	00	Inactivity time
39	ACT_INACT_CTL	R/W	00	Axis enable control for activity and inactivity detection
40	THRESH_FF	R/W	00	Free-fall threshold
41	TIME_FF	R/W	00	Free-fall time
42	TAP_AXES	R/W	00	Axis control for single tap/double tap
43	ACT_TAP_STATUS	R	00	Source of single tap/double tap
44	BW_RATE	R/W	0A	Data rate and power mode control
45	POWER_CTL	R/W	0A	Power-saving features control
46	INT_ENABLE	R/W	00	Interrupt enable control
47	INT_MAP	R/W	00	Interrupt mapping control

4.1 G-Sensor Registers

Selects the registers inside G-Sensor to read or write the data.

This close-up shows the 'G-Sensor Reg Index' dropdown menu set to '45 : POWER_CTL'. To its right are two buttons: 'Read G-Sensor Data' and 'Write G-Sensor Data', both with '0A' values.

4.2 Register Table

Shows the value of all registers in G-Sensor, once the Refresh Button is pressed.

This screenshot shows the Register Table after a refresh. The table lists all registers with their current values. A 'Refresh' button is visible on the right side of the table.

Num	Name	Type	Value	Description
0	DEVID	R	E5	Device ID
1~28	Reserved			Reserved; do not access
29	THRESH_TAP	R/W	00	Tap threshold
30	OFSX	R/W	00	X-axis offset
31	OFSY	R/W	00	Y-axis offset
32	OFSZ	R/W	00	Z-axis offset
33	DUR	R/W	00	Tap duration
34	Latent	R/W	00	Tap latency
35	Window	R/W	00	Tap window
36	THRESH_ACT	R/W	00	Activity threshold
37	THRESH_INACT	R/W	00	Inactivity threshold
38	TIME_INACT	R/W	00	Inactivity time
39	ACT_INACT_CTL	R/W	00	Axis enable control for activity and inactivity detection
40	THRESH_FF	R/W	00	Free-fall threshold
41	TIME_FF	R/W	00	Free-fall time
42	TAP_AXES	R/W	00	Axis control for single tap/double tap
43	ACT_TAP_STATUS	R	00	Source of single tap/double tap
44	BW_RATE	R/W	0A	Data rate and power mode control
45	POWER_CTL	R/W	0A	Power-saving features control
46	INT_ENABLE	R/W	00	Interrupt enable control
47	INT_MAP	R/W	00	Interrupt mapping control

5. Tracker

The screenshot shows the VTC1020_Utility application window with the Tracker tab selected. The configuration fields are as follows:

- WWAN APN: internet
- WWAN DNS1: 8.8.8.8
- WWAN DNS2: 8.8.4.4
- Server IP: 59.120.0.36
- Server Port: 1200
- Machine Name: VTC1020
- Phone Number: 01
- SMS: Disable
- SMS Coding Type: ASCII Code
- SMS Content: Help
- Tracker: Disable
- Tracker Mode: Event
- Activation Time: 10 Second
- Send Period: 1 min
- Acceleration Force: 8 g
- Tilt Angle: 30°
- IMEI: (empty)

5.1 Network Settings

Configures the network settings for the server.

The screenshot shows the Network Settings configuration form with the following values:

- WWAN APN: internet
- WWAN DNS1: 8.8.8.8
- WWAN DNS2: 8.8.4.4
- Server IP: 59.120.0.36
- Server Port: 1200

APN: internet (default). It can be adjusted based on users' situation.

DNS1: 8.8.8.8 (default). It can be adjusted based on users' situation.

DNS2: 8.8.4.4 (default)

Server IP: 59.120.0.36 (default). It can be adjusted based on users' situation.

Server Port: 1200 (default). It can be adjusted based on users' situation.

5.2 SMS and Phone Number

Configures the SMS content and phone numbers for delivering SMS message.

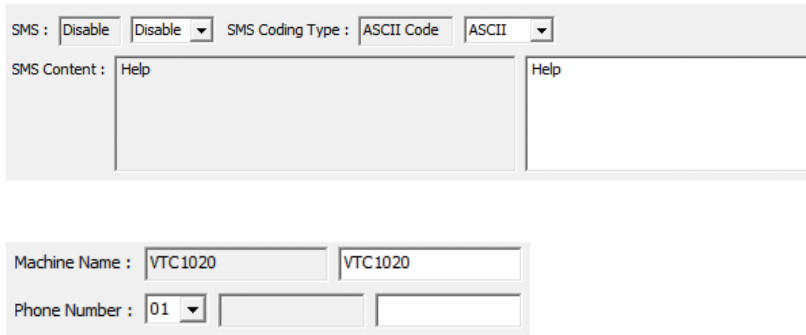

SMS : Disable Disable SMS Coding Type : ASCII Code ASCII

SMS Content :

Machine Name :

Phone Number :

If SMS Control is enabled, once event is triggered (defined by Acceleration Force & Tilt Angle), SMS Message will be sent to the phone numbers that are registered automatically. There are up to 10 phone numbers that can be registered. SMS Content can be defined inside the text field.

5.3 Tracker Settings

Configures settings for the tracker.

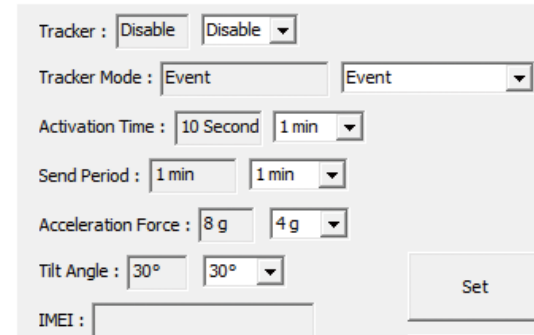

Tracker : Disable Disable

Tracker Mode :

Activation Time :

Send Period :

Acceleration Force :

Tilt Angle :

IMEI :

If Tracker function is “Enable” and Tracker Mode is “Event”, once event is triggered (defined by Acceleration Force & Tilt Angle), following information will be sent to server.

If Tracker function is “Enable” and Tracker Mode is “Continue”, following information will be sent to server, based on the interval time defined in Send Period.

(Information)

Date: YYMMDD

Time: HHMMSS

GPS Status: 0: Searching 1: Fixed

GPS Latitude

GPS Longitude

G Sensor X value: 0 ~ 65535

G Sensor Y value: 0 ~ 65535

G Sensor Z value: 0 ~ 65535

Activation Time: Define when tracker function starts after ignition signal becomes low.

Send Period: Define the interval time to send the information to server, when Tracker Mode is "Continue".

Acceleration Force: Define the value of G-sensor that triggers the event.

Tilt Angle: Define the value of tilt angle that triggers the event.

IMEI: IMEI of WWAN module will be shown.



Note:

It is required to press the Save Button for saving the settings made in the Utility.

APPENDIX B: GPS FEATURE

uBlox-NEO M8N Overview

The NEO-M8 series of standalone concurrent GNSS modules is built on the exceptional performance of the u-blox M8 GNSS (GPS, GLONASS, Galileo, BeiDou, QZSS and SBAS) engine in the industry proven NEO form factor.

The NEO-M8 series provides high sensitivity and minimal acquisition times while maintaining low system power. The NEO form factor allows easy migration from previous NEO generations. Sophisticated RF-architecture and interference suppression ensure maximum performance even in GNSS-hostile environments.

The NEO-M8 combines a high level of robustness and integration capability with flexible connectivity options. The future-proof NEO-M8N includes an internal Flash that allows simple firmware upgrades for supporting additional GNSS systems. This makes NEO-M8 perfectly suited to industrial and automotive applications.

The DDC (I2C compliant) interface provides connectivity and enables synergies with most u-blox cellular modules. For RF optimization the NEO-M8N features an additional front-end LNA for easier antenna integration and a front-end SAW filter for increased jamming immunity.

u-blox M8 modules use GNSS chips qualified according to AEC-Q100, are manufactured in ISO/TS 16949 certified sites, and fully tested on a system level. Qualification tests are performed as stipulated in the ISO16750 standard: "Road vehicles – Environmental conditions and testing for electrical and electronic equipment".

Technical Specifications

COM Port for GPS: COM 4

Baud Rate: 9600

Features

Receiver type	72-channel u-blox M8 engine GPS/QZSS L1 C/A, GLONASS L10F, BeiDou B1 SBAS L1 C/A: WAAS, EGNOS, MSAS Galileo-ready E1B/C (NEO-M8N)		
Nav. update rate¹	Single GNSS: up to 18 Hz Concurrent GNSS: up to 10 Hz		
Position accuracy	2.0 m CEP		
		NEO-M8N/Q	NEO-M8M
Acquisition	Cold starts:	26 s	27 s
	Aided starts:	2 s	4 s
	Reacquisition:	1 s	1 s
Sensitivity	Tracking & Nav:	-167 dBm	-164 dBm
	Cold starts:	-148 dBm	-147 dBm
	Hot starts:	-156 dBm	-156 dBm
Assistance	AssistNow GNSS Online AssistNow GNSS Offline (up to 35 days) AssistNow Autonomous (up to 6 days) OMA SUPL & 3GPP compliant		
Oscillator	TCXO (NEO-M8N)		
RTC crystal	Built-in		
Noise figure	Extra LNA for lowest noise figure (NEO-M8N)		

Features cont.

Anti jamming	Active CW detection and removal. Extra onboard SAW band pass filter (NEO-M8N)
Memory	Flash (NEO-M8N)
Supported antennas	Active and passive
Odometer	Travelled distance
Data-logger	For position, velocity, and time (NEO-M8N)

¹ For NEO-M8M/Q

Electrical data

Supply voltage	2.7 V to 3.6 V (NEO-M8N)
Power consumption²	23 mA @ 3.0 V (continuous) 5 mA @ 3.0 V Power Save Mode (1 Hz, GPS only)
Backup Supply	1.4 to 3.6 V

² NEO-M8M

Interfaces

Serial interfaces	1 UART 1 USBV2.0 full speed 12 Mbit/s 1 SPI (optional) 1 DDC (I ² C compliant)
Digital I/O	Configurable timepulse 1 EXTINT input for Wakeup
Timepulse	Configurable 0.25 Hz to 10 MHz
Protocols	NMEA, UBX binary, RTCM

VIOB-GPS-02 Module Connector Pin Definitions



J2 (GPS Side)



J8 (PC Side)

J2 Pin Definition

Pin	Definition	Pin	Definition
1	GPS_3V3	2	GND
3	GPS_TXD_M	4	GPS_RXD_M
5	NC	6	+V3.3ALW

J8 Pin Definition

Pin	Definition	Pin	Definition
1	GPS_BAT	2	GPS_LED
3	CTX	4	CRX
5	GND	6	VCC3_GPS

APPENDIX C: GPS WITH DEAD RECKONING FEATURE (FOR VTC 1020 SERIES)

uBlox-NEO M8L Overview

The NEO-M8L standalone concurrent GNSS module with 3D dead-reckoning (DR) is built on the exceptional performance of the u-blox M8 concurrent GNSS (GPS, GLONASS, Galileo-ready¹, BeiDou, QZSS and SBAS) engine in the compact and industry proven NEO form factor.

The NEO-M8L delivers a complete, self-contained solution for road-vehicle Automotive Dead Reckoning (ADR) applications in an exceptionally compact 16 x 12 mm form-factor. The module combines information from GNSS, on-board 3-Dimensional inertial sensors, and speed data from the vehicle to deliver continuous navigation in road-vehicle applications. Its size and features make it suitable for aftermarket and first-fit navigation and Telematics applications. Position measurement rates of up to 2 Hz are available with optional extrapolation (based on vehicle dynamics) extending reporting rates to 20 Hz. Inertial sensor measurements are available to external applications at rates up to 10 Hz.

For ease of application, both hardware and message interfaces are supported for vehicle speed. u-blox' ADR and GNSS technologies deliver continuous and accurate positioning throughout the journey. u-blox' tightly-coupled navigation solution delivers significant improvements in navigation accuracy, especially in difficult urban environments. Dead reckoning sensors in conjunction with speed information from the vehicle also provide navigation before GNSS signals are acquired and during periods of complete signal loss. The introduction of three dimensional sensing and signal processing (for both acceleration and direction) extend accurate navigation to urban multi-level highways and car-parks as well as extending dead-reckoned range in tunnels and urban canyons. 3D sensing also enables flexibility in orientation of the receiver with respect to the vehicle frame.

The NEO form factor allows easy migration from previous NEO generations. Sophisticated RF architecture and interference suppression ensure maximum performance even in GNSS-hostile environments. The NEO-M8L module includes an internal Flash that allows simple firmware upgrades. These features make the NEO-M8L perfectly suited to industrial and automotive applications. UART, SPI and DDC (I²C compatible) interfaces provide connectivity and enable synergies with most u-blox cellular modules.

u-blox M8 modules use GNSS chips qualified according to AEC-Q100, and are manufactured in ISO/TS 16949 certified sites. Qualification tests are performed as stipulated in the ISO16750 standard: "Road vehicles - Environmental conditions and testing for electrical and electronic equipment".

u-blox' AssistNow Assistance services supply aiding information, such as ephemeris, almanac and time, reducing the time to first fix significantly and improving acquisition sensitivity. The u-blox M8 generation extends validities of AssistNow Offline data (up to 35 days) and AssistNow Autonomous data (up to 6 days), providing the benefits of faster acquisition for longer durations since last use.

¹ With future flash firmware update.

Technical Specifications

COM Port for GPS: COM 4

Baud Rate: 9600

Parameter	Specification			
Receiver type	72-channel u-blox M8 engine GPS L1C/A, SBAS L1C/A, QZSS L1C/A GLONASS L1OF, BeiDou B1, Galileo E1B/C ²			
GNSS	GPS & GLONASS	GPS & BeiDou	GPS	
Time-To-First-Fix³	Cold start	27 s	28 s	30 s
	Hot start	1.5 s	1.5 s	1.5 s
	Aided starts ⁴	4 s	6 s ⁵	3 s
Sensitivity⁶	Tracking & Navigation ⁷	-160 dBm	-160 dBm	-160 dBm
	Reacquisition	-159 dBm	-159 dBm	-159 dBm
	Cold start	-147 dBm	-147 dBm	-147 dBm
	Hot start	-156 dBm	-156 dBm	-156 dBm
Navigation	GPS & GLONASS	GPS & BeiDou	GPS	
Horizontal Position accuracy⁸	Autonomous	2.5 m	2.5 m	2.5 m
	SBAS	2.0 m	2.0 m	2.0 m
Velocity accuracy⁹		0.05 m/s	0.05 m/s	0.05 m/s
Heading accuracy⁹		0.3 degree	0.3 degree	0.3 degree
ADR position error¹⁰	Gyro + speed pulse + accelerometer		typ. 3 % of distance travelled without GNSS	
Frequency of time pulse signal			0.25 Hz ... 10 MHz	
Maximum navigation rate (High Rate output)¹¹			20 Hz	

Navigation	GPS & GLONASS	GPS & BeiDou	GPS	
Maximum navigation rate (Measurement rate)		2 Hz		
Navigation latency¹²		300 ms nominal		
Maximum sensor measurement message output rate		10 Hz		
Sensor measurement message output bandwidth¹³		nominal 50% of output rate		
Accuracy of time pulse signal	RMS 99%	30 ns	30 ns	30 ns
		60 ns	60 ns	60 ns
Operational limits	Dynamics		≤ 4G	
	Altitude		50,000m	
	Velocity		500 m/s	

² Ready to support Galileo E1B/C when available with a flash firmware update³ All signals at -130 dBm⁴ Dependent on aiding data connection speed and latency⁵ BeiDou assisted acquisition is not available⁶ Demonstrated with a good external LNA⁷ Optimized for best navigation performance with dead-reckoning⁸ GNSS fix available, CEP, 50%, 24 hours static, -130dBm, > 6 SVs⁹ GNSS fix available, 50% @ 30 m/s¹⁰ Typical road and vehicle conditions¹¹ For update rates > 2 Hz, extrapolation techniques are applied.¹² Dependent on signal conditions but measurements are delivered with time-stamp corresponding to measurement time¹³ Higher bandwidths are used for navigation¹⁴ Assuming Airborne < 4 g platform

Module Connector Pin Definitions

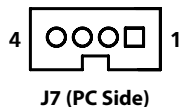
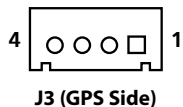

J3 Pin Definition

Pin	Definition	Pin	Definition
1	DR_DIRECTIO_M_R	2	DR_ODOMETER_M_R
3	1PPS_R	4	GND

J7 Pin Definition

Pin	Definition	Pin	Definition
1	GND	2	1PPS
3	DR_ODOMETER_M	4	DR_DIRECTIO_M

VIOB-GPS-02 Module Connector Pin Definitions

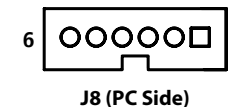
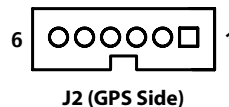

J2 Pin Definition

Pin	Definition	Pin	Definition
1	GPS_3V3	2	GND
3	GPS_TXD_M	4	GPS_RXD_M
5	NC	6	+V3.3ALW

J8 Pin Definition

Pin	Definition	Pin	Definition
1	GPS_BAT	2	GPS_LED
3	CTX	4	CRX
5	GND	6	VCC3_GPS

APPENDIX D: SIGNAL CONNECTION OF PROGRAMMABLE DI/DO

Multi Port Pinout Description

Connector location: CN2

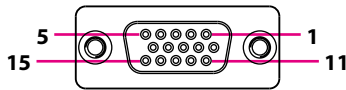

Pin	Definition	Pin	Definition
1	DIRECTION	2	RXD3_R
3	GPIO1	4	GPIO4
5	GND	6	1PPS
7	TXD3_R	8	CAN1_L
9	GPIO3	10	GND
11	ODOMETER	12	CAN1_H
13	GPIO2	14	GPIO5
15	GND		

GPIO and CAN Terminal Setting

Connector location: SW1

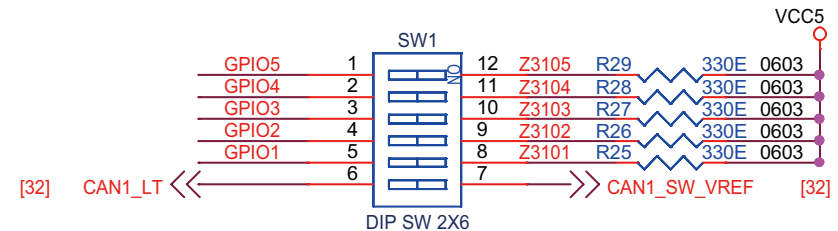

SW	On (Default)	Off
SW1.1	Pull up VCC5	Don't care
SW1.2	Pull up VCC5	Don't care
SW1.3	Pull up VCC5	Don't care
SW1.4	Pull up VCC5	Don't care
SW1.5	Pull up VCC5	Don't care
SW1.6	Enable terminal resistor	Disable terminal resistor

Digital Input

Wet Contact (default)

The GPI signals have a pull up resistor to 5V internally.

The figure below shows how to connect an external output source to one of the input channel.

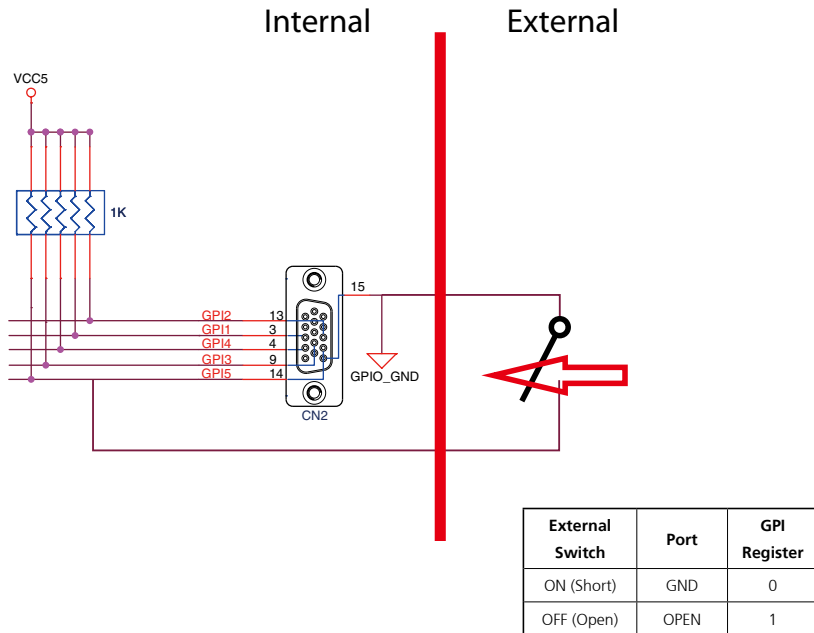

Dry Contact:

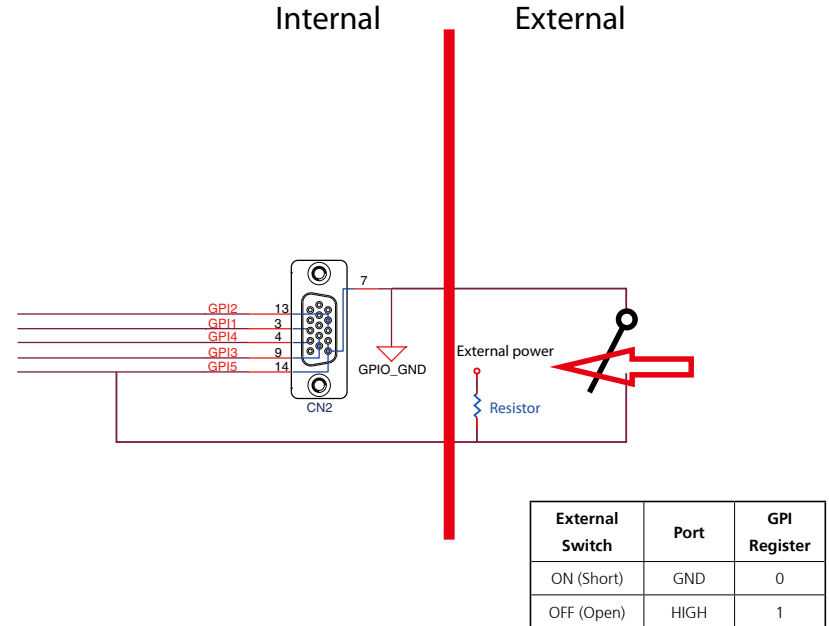

Digital Output

CN2 connector for GPO signal (digital signal output)

The CN2 connector has 4 digital output channels by default. The signal connection of CN2 support two connected methods for output signal type.

The output signal has two states, one is low level (driven to 0V from GPO signal) other is open (high voltage is provided from external device).

Wet Contact (default)

The SW1 needs to switch to "ON" state. The GPO signal will have a pull up resistor to 5V internally when you switch "SW1" to "ON" state. The output signal has two states, one is low level (driven to 0V from GPO signal) other is high level (driven to 5V from GPO signal).

The figure below shows how to connect an external input source to one of the output channel.

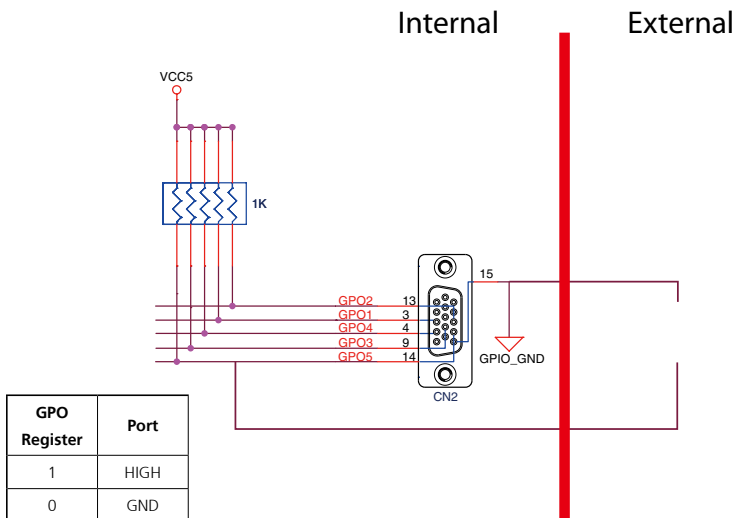

Dry Contact

Each channel can accept 3~18Vdc voltage. And it is able to drive 150mA current for low level.

The SW1 needs to switch to "OFF" state. The GPO signal will no have a pull up resistor internally when you switch "SW1" to "OFF" state.

The figure below shows how to connect an external input source to one of the output channel.

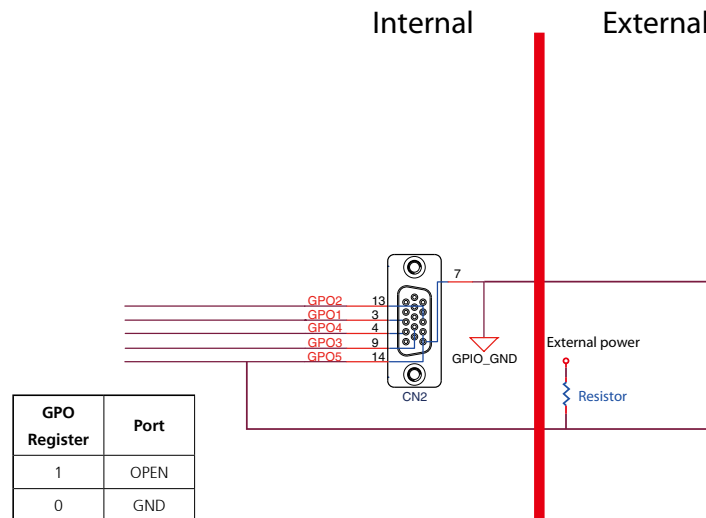

APPENDIX E: VEHICLE POWER MANAGEMENT SETUP

Entering BIOS Menu

In the BIOS menu, go to **Advanced**→**Power Management Configuration**.



Startup and Shutdown Voltage Setting

Set the startup voltage to 11.5V or 23V and the shutdown voltage to 10.5V or 21V. If the input voltage is 12V: the startup voltage to 11.5V and the shutdown voltage to 10.5V.

If the input voltage is 24V: the startup voltage to 23V and the shutdown voltage to 21V.

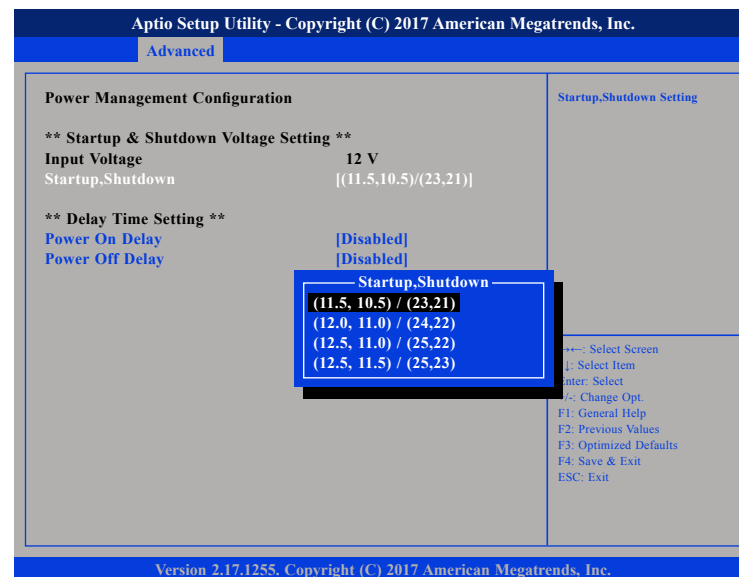

Set the startup voltage to 12.0V or 24V and the shutdown voltage to 11.0V or 22V

If the input voltage is 12V: the startup voltage to 12V and the shutdown voltage to 11V.

If the input voltage is 24V: the startup voltage to 24V and the shutdown voltage to 22V.

Set the startup voltage to 12.5V or 25V and the shutdown voltage to 11.0V or 22V

If the input voltage is 12V: the startup voltage to 12.5V and the shutdown voltage to 11V.

If the input voltage is 24V: the startup voltage to 25V and the shutdown voltage to 22V.

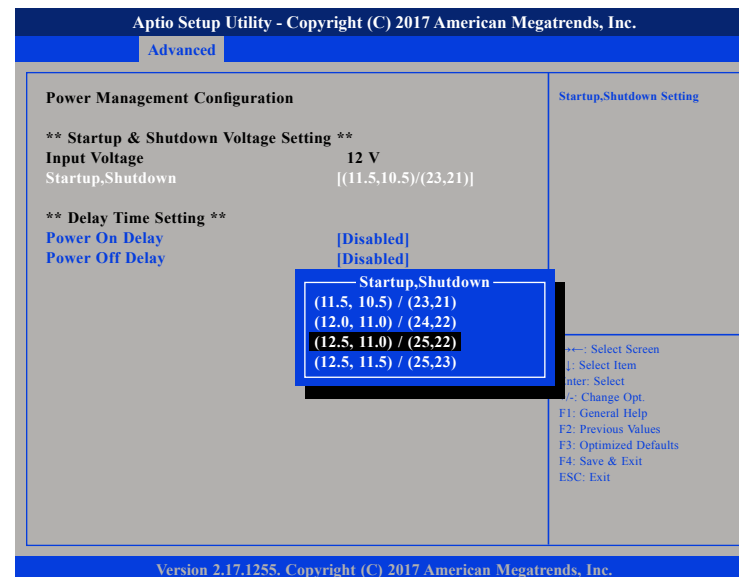
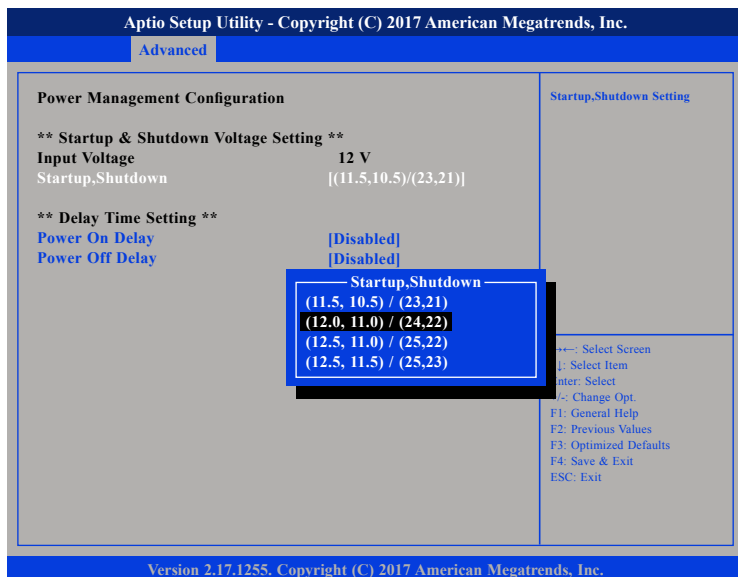

Set the startup voltage to 12.5V or 25V and the shutdown voltage to 11.0V or 22V

If the input voltage is 12V: the startup voltage to 12.5V and the shutdown voltage to 11.5V.

If the input voltage is 24V: the startup voltage to 25V and the shutdown voltage to 23V.

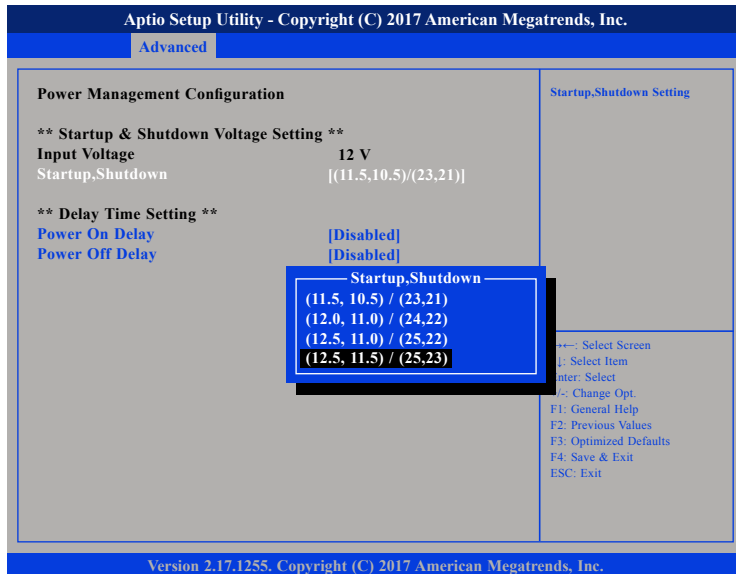

Power-on Delay Setting

Disable Power-on Delay

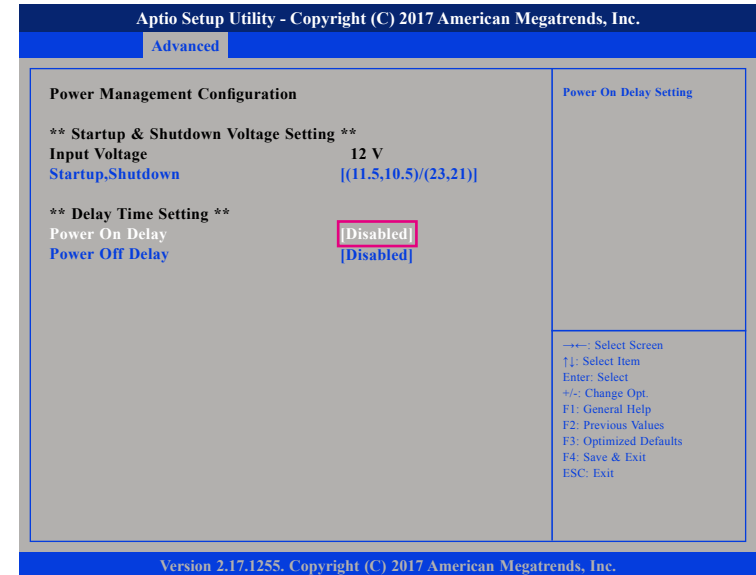

Enable Power-on Delay

Delay time can be set at 10sec/30sec/1min./5min./10min./15min./30min./1hour.

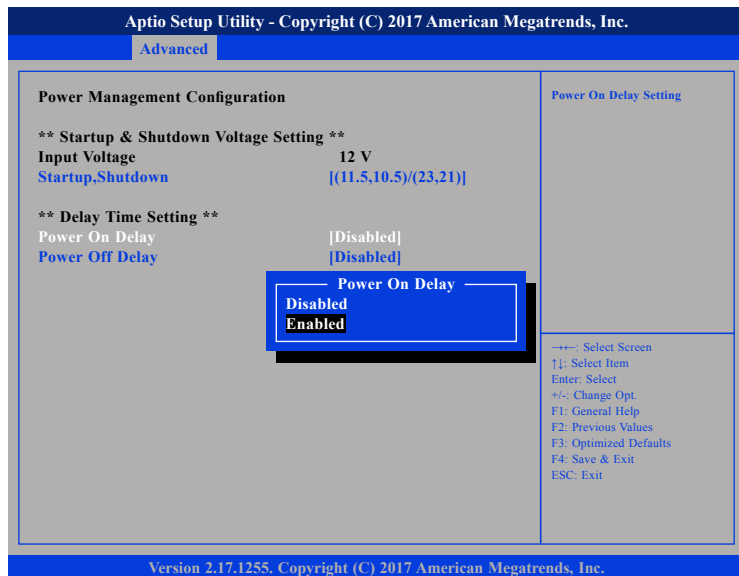

Power-off Delay Setting

Disable Power-off Delay



Enable Power-off Delay

Delay time can be set at 20sec/1min./5min./10min./30min./1hour/6hour/18hour.



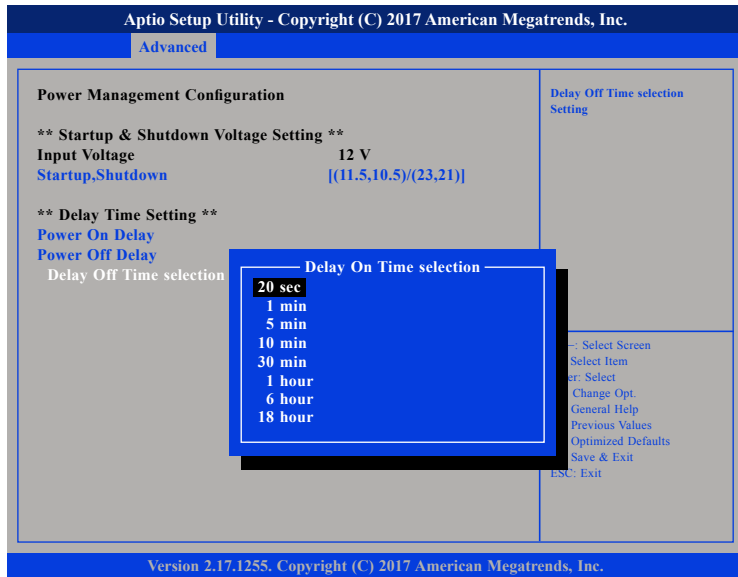

APPENDIX F: POWER CONSUMPTION

VTC 1020/VTC 1020-PA/nROK 1020

Idle: Into OS + VGA/HDMI/LVDS display + Keyboard & Mouse + Speaker + mSATA

Full State: Run BURN-IN + VGA/HDMI/LVDS display + Keyboard & Mouse + Speaker (Sound volume max) +3D LINK (player Video) + mSATA + COM loopback + GPIO LED x5

Full State + Loading: Run BURN-IN + VGA/HDMI /LVDS display + Keyboard & Mouse + Speaker (Sound volume max) +3D LINK (player Video) + mSATA + COM loopback + GPIO LED x5 + load (12V/2A, 5V/0.5A, 5V/1A x2)

Device	Test Case		Result	
			Current(A)	Watt(W)
S0 State	Idle State	12V	1.323	15.876
		24V	0.689	16.536
		36V	0.516	18.576
	Full State	12V	1.733	20.796
		24V	0.906	21.744
		36V	0.701	25.236
	Full State + Loading	12V	5.107	61.284
		24V	2.483	59.592
		36V	1.688	60.768

APPENDIX G: PIN DEFINITION FOR THE MULTIPORT AND COM CABLE

The multiport consists of a 15-pin connector and multiple output connectors. The following tables list the pin signals of the P0 connector and its corresponding pin signals to the output connectors.

Multiport Cable

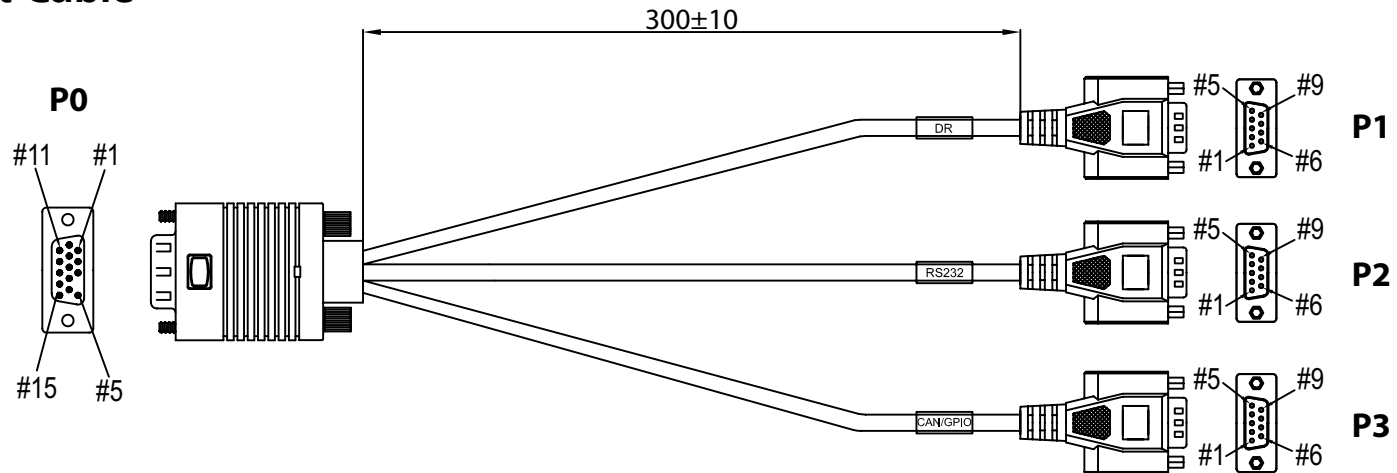

P0 Connector Pinout

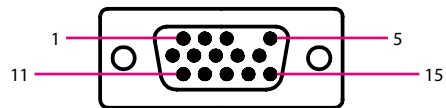

Pin	Definition	Pin	Definition
1	DIRECTION	2	RXD3_R
3	GPIO1	4	GPIO4
5	GND	6	1PPS
7	TXD3_R	8	CAN1_L
9	GPIO3	10	GND
11	ODOMETER	12	CAN1_H
13	GPIO2	14	GPIO5
15	GND		

P1 to P3 Connector Pinouts DR Connector (For VTC 1020 Series)

Connector location: P1

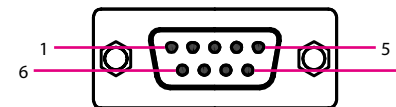

P0 Pin	P1 Pin	Definition
1	1	DIRECTION
5	6	GND
6	5	1PPS
11	3	ODOMETER

RS-232 (Tx/Rx) Connector

Connector location: P2

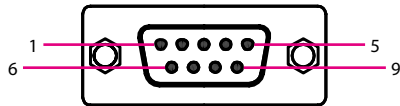

P0 Pin	P2 Pin	Definition
2	2	RXD3_R
7	3	TXD3_R
10	5	GND

CAN/GPIO Connector

Connector location: P3

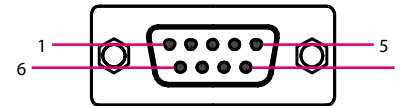

P0 Pin	P3 Pin	Definition
3	1	GPIO1
4	4	GPIO4
8	8	CAN1_L
9	3	GPIO3
12	7	CAN1_H
13	2	GPIO2
14	5	GPIO5
15	6	GND

COM Cable

The COM cable consists of a 15-pin connector and multiple output connectors. The following tables list the pin signals of the P0 connector and its corresponding pin signals to the output connectors.

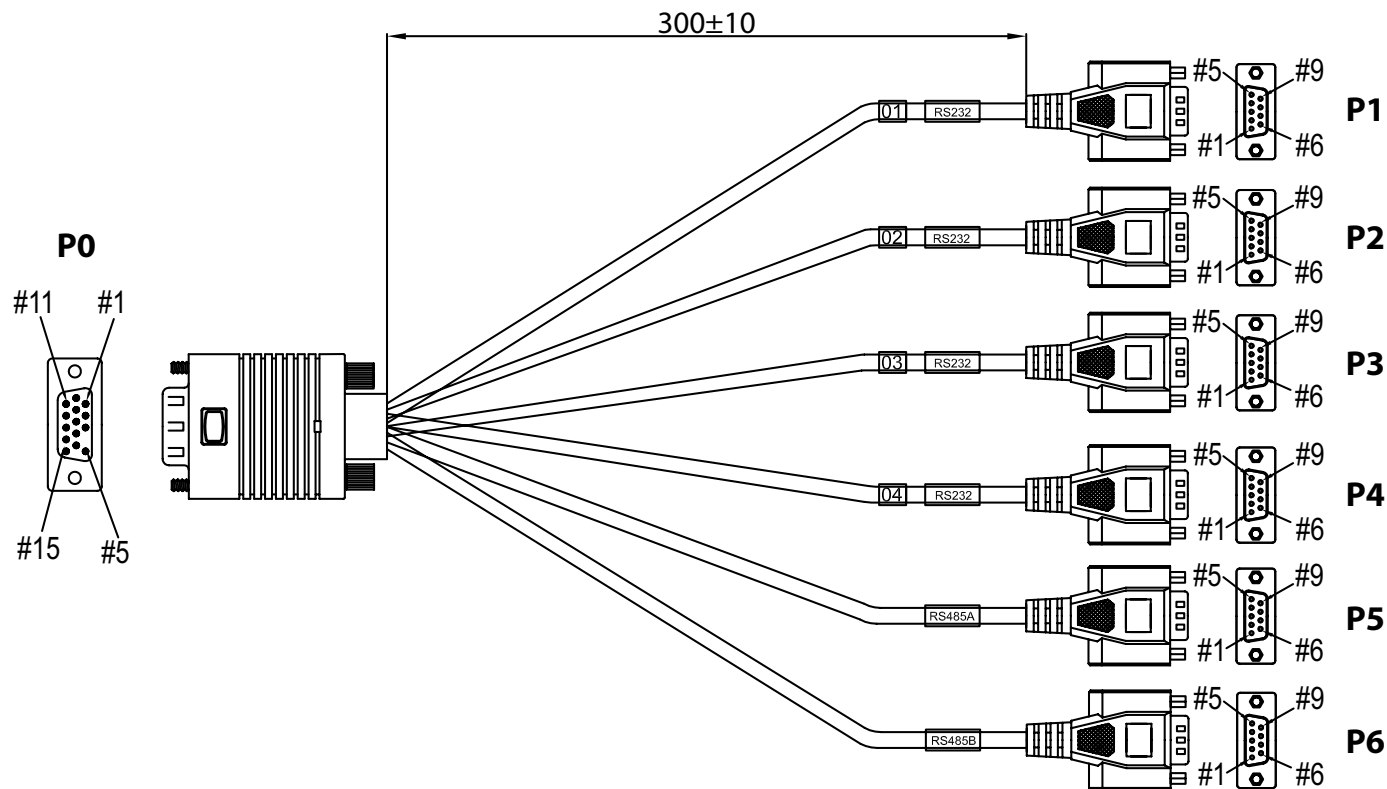

P0 Connector Pinout

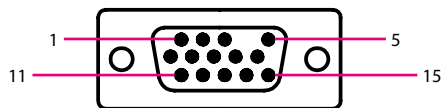

Pin	Definition	Pin	Definition
1	RXD_R_D	2	TXD2_R
3	RXD1_R	4	RS485B_-
5	GND	6	TXD_R_D
7	TXD_R_B	8	TXD1_R
9	RS485A_+	10	GND
11	RXD_R_D	12	RXD2_R
13	RS485A_-	14	RS485B_+
15	GND		

P1 to P6 Connector Pinouts RS-232 (Tx/Rx) Connector

Connector location: P1

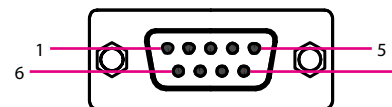

P0 Pin	P1 Pin	Definition
1	2	RXD_R_D
5	5	GND
6	3	TXD_R_D

RS-232 (Tx/Rx) Connector

Connector location: P2

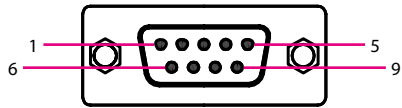

P0 Pin	P2 Pin	Definition
5	5	GND
7	3	TXD_R_B
11	2	RXD_R_D

RS-232 (Tx/Rx) Connector

Connector location: P3

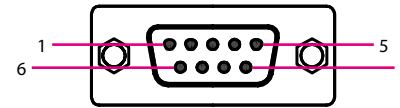

P0 Pin	P3 Pin	Definition
2	3	TXD2_R
10	5	GND
12	2	RXD2_R

RS-232 (Tx/Rx) Connector

Connector location: P4

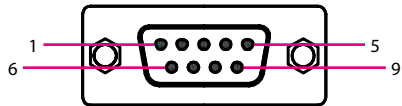

P0 Pin	P4 Pin	Definition
3	2	RXD1_R
8	3	TXD1_R
10	5	GND

RS-485 Connector

Connector location: P5

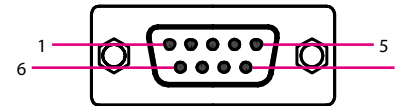

P0 Pin	P5 Pin	Definition
9	3	RS485A_+
13	2	RS485A_-
15	5	GND

RS-485 Connector

Connector location: P6

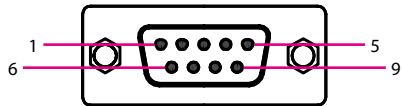

P0 Pin	P6 Pin	Definition
4	2	RS485B_-
14	3	RS485B_+
15	5	GND