Getting Started : The XP-8xx7-CE6 PAC

The XP-8xx7-CE6 is the abbreviation of the XP-8047-CE6/8347-CE6/8747-CE6.
The XP-8xx6-CE6 is the abbreviation of the XP-8046-CE6/8346-CE6/8746-CE6.

Important Notice

1. **XP-8xx7-CE6/8xx6-CE6 supports only the High profile I-8K and I-87K I/O cards in its slot 1 to 7.** Please refer to XP-8xx7-CE6 CD: [\napdos\isagraf\xp-8xx7-ce6\english-manu\](#) for Data sheet.
2. Please always set a fixed IP address to the XP-8xx7-CE6. (No DHCP)
3. Please always set XPAC's LAN2 as disabled if not using it (refer to appendix D).
4. Recommend to use the NS-205 or NS-208 Industrial Ethernet Switch for the XPAC.

Legal Liability

ICP DAS CO., LTD. assumes no liability for any and all damages that may be incurred by the user as a consequence of this product. **ICP DAS CO., LTD. reserves the right to change this manual at any time without notice.**

ICP DAS CO., LTD. constantly strives to provide our customers with the most reliable and accurate information possible regarding our products. However, ICP DAS CO., LTD. assumes no responsibility for its use, or for any infringements of patents or other rights of third parties resulting from its use.

Trademark & Copyright Notice

The names of products and name of company are used for identification purposes only, and are the registered trademarks of their respective owners or companies.

Development Software

Two options:

- ISaGRAF: Ver. 3.4x or Ver. 3.5x, IEC 61131-3 standard. LD, ST, FBD, SFC, IL & FC or
- Non-ISaGRAF: Microsoft EVC++4.0 or VS.NET 2008/2005/2003 (VB.net, C#.net)

Reference Guide

- ISaGRAF English User's Manual:

XP-8xx7-CE6 CD: [\napdos\isagraf\xp-8xx7-ce6\english-manu\](#) "user_manual_i_8xx7.pdf" & "user_manual_i_8xx7_appendix.pdf"

- ISaGRAF 中文進階使用手冊:

XP-8xx7-CE6 CD: [\napdos\isagraf\xp-8xx7-ce6\chinese-manu\](#) "chinese_user_manual_i_8xx7.pdf" & "chinese_user_manual_i_8xx7_appendix.pdf"

- More from the Internet:

<http://www.icpdas.com/products/PAC/i-8000/isagraf.htm>

Technical Service:

Please contact local agent or email problem-report to service@icpdas.com .

FAQ : <http://www.icpdas.com/faq/isagraf.htm>

*Written by Chun Tsai; Edited by Eva Li.
Copyright Jan. 2010, by ICP DAS CO., LTD. All Rights Reserved.*

Table of Contents

GETTING STARTED : THE XP-8XX7-CE6 PAC.....	1
Important Notice.....	1
Legal Liability	1
Trademark & Copyright Notice	1
Development Software	1
Reference Guide	1
Technical Service:.....	1
TABLE OF CONTENTS	2
REFERENCE GUIDE	6
I/O MODULES SELECTION GUIDE FOR XP-8XX7-CE6 SERIES.....	7
PERFORMANCE COMPARISON TABLE OF ISAGRAF PACS	12
SPECIFICATIONS: XP-8047-CE6/ 8347-CE6/ 8747-CE6.....	13
CHAPTER 1 TYPICAL APPLICATION.....	2-1
1.1 Motion Control : Using I-8094F/8092F/8094	2-1
1.2 Soft-GRAF HMI : Create A Colorful HMI	2-2
1.3 eLogger HMI Application	2-2
1.4 Connect the Smart Power Meter PM-2133/2134	2-3
1.5 Redundant Communication System.....	2-4
1.6 Redundant System - Ethernet I/O	2-4
1.7 Redundant System – Hot-Swap RS-485 I/O	2-5
1.8 Redundant System – with iDCS-8000	2-5
1.9 Modbus Master: TCP/IP	2-6
1.10 Modbus Master: RTU, ASCII, RS-232/485/422	2-6
1.11 Modbus Slave: RTU/TCP	2-7
1.12 Communicate With Other TCP/IP Server or UDP Client/Server Devices	2-7
1.13 Multiple Web HMI – Monitor & Control Everywhere!.....	2-8
1.14 Send Email With or Without One Attached File.....	2-8
1.15 Data-Recorder & Data-Logger	2-9
1.16 Remote I/O Application.....	2-9
1.17 SMS: Short Message Service	2-10
1.18 Auto-report Acquisition & Control Data	2-10
1.19 Stress Monitoring Application of Constructions	2-11
1.20 Fast FRnet Remote I/O	2-12
1.21 Integrate with CAN/CANopen Devices & Sensors.....	2-12
1.22 ZigBee Wireless Solution	2-13
1.23 GPS Application: with I-87211W & GPS-721	2-14
CHAPTER 2 SOFTWARE INSTALLATION AND WORKING SOFT-GRAF HMI WITH ISAGRAF.....	2-1
2.1 Step 1 - Installing The ISaGRAF Software	2-1
2.1.1 The hardware protection device (dongle & USB Key-Pro)	2-3
2.1.2 Important Notice For Window NT Users	2-4
2.1.3 Important Notice For Windows 2000 users.....	2-4

2.2	Step 2 - Installing The ICP DAS Utilities For ISaGRAF	2-6
2.3	Step 3 - Installing The Web Page Editor	2-7
2.4	Working eLogger HMI with ISaGRAF SoftLogic	2-8
2.5	Working Soft-GRAF HMI with ISaGRAF SoftLogic.....	2-9
CHAPTER 3	SETTING UP A WEB HMI DEMO	3-1
3.1	Web Demo List	3-1
3.2	Steps To Set Up A Web HMI Demo	3-2
3.2.1	Step 1 - Setup The Hardware	3-2
3.2.2	Step 2 - Setting The Web Options	3-2
3.2.3	Step 3 - Download ISaGRAF Project	3-3
3.2.4	Step 4 - Download Web Pages To The XPAC.....	3-6
3.2.5	Step 5 - Show Time.....	3-6
CHAPTER 4	PROGRAMMING A WEB HMI EXAMPLE	4-1
4.1	Writing A Simple ISaGRAF Program	4-1
4.1.1	Open ISaGRAF-Project Management.....	4-2
4.1.2	Creating An ISaGRAF User's Group	4-3
4.1.3	Creating A New ISaGRAF Project	4-3
4.1.4	Declaring The ISaGRAF Project Variables.....	4-4
4.1.5	Assign Modbus Network Address No to Variables	4-8
4.1.6	Create The LD - "LD1" Program.....	4-9
4.1.7	Edit The "LD1" Program	4-10
4.1.8	Connecting The I/O	4-14
4.2	Compiling & Simulating The Example Project	4-17
4.3	Download & Debug The Example Project	4-21
4.4	Design The Web Page	4-26
4.4.1	Step 1 – Copy The Sample Web HMI pages	4-26
4.4.2	Step 2 – Building The Main.htm.....	4-27
4.4.3	Step 3 – Adding Control Code To The Main.htm	4-32
4.4.4	Step 4 – Download Web HMI Pages To The Controller	4-39
CHAPTER 5	WEB HMI BASICS	5-1
5.1	Basic Files For The Web HMI	5-1
5.2	Login.htm.....	5-2
5.3	Menu.htm.....	5-4
5.4	Main.htm	5-6
5.4.1	A Simple Main.htm Example	5-6
5.4.2	More About The refresh_data() Function And Dynamic Data.....	5-8
5.4.3	Post Data To The Controller	5-13
5.5	Multi-Pages.....	5-19
5.5.1	Level 2 And Level 3 Page	5-19
5.5.2	Switch One Page To One Another Page	5-20
5.6	Web Security	5-21
CHAPTER 6	VB.NET 2008 PROGRAM RUNNING IN XP-8XX7-CE6 ACCESS TO ISAGRAF VARIABLES 6-1	
6.1	Create a New Project.....	6-1
6.2	Add Project Reference for an Application	6-2
6.3	Compiling an Application Program.....	6-5
6.4	QuickerNET.DLL	6-6
6.4.1	Digital R/W Functions	6-6
6.4.2	Analog R/W Functions.....	6-7

CHAPTER 8	INDUSOFT PROJECT RUNNING IN XPAC ACCESS TO ISAGRAF VARIABLES.....	8-1
CHAPTER 9	EXAMPLE PROGRAM & FAQ.....	9-1
9.1	Get On-Line Help	9-1
9.2	Installing The ISaGRAF Programming Examples.....	9-4
9.3	Frequently Asked Questions.....	9-12
CHAPTER 10	C# .NET 2008 PROGRAM RUNNING IN THE XP-8XX7-CE6 ACCESS TO ISAGRAF VARIABLES.....	10-1
10.1	Create a New Project.....	10-1
10.2	Add Project Reference for an Application.....	10-2
10.3	Compiling an Application Program.....	10-5
10.4	QuickerNET.DLL	10-6
10.4.1	Digital R/W Functions	10-6
10.4.2	Analog R/W Functions.....	10-7
CHAPTER 11	MOTION CONTROL - USING I-8094F/8092F/8094.....	11-1
11.1	Hardware / Software Requirement.....	11-1
	Hardware Requirement for the demo examples :	11-1
	Hardware Wiring :.....	11-2
	ISaGRAF IO Library :	11-2
	ISaGRAF Demo Programs :	11-2
11.2	Introduction and installation for I-8094F/8092F/8094	11-4
11.2.1	Introduction	11-4
11.2.2	Hardware Specification	11-4
11.2.3	Hardware Connection	11-4
11.2.4	Installation for the Motion Module	11-5
11.2.5	Install the C function "Z_8094" into the ISaGRAF.....	11-7
11.2.6	Install the I/O connection: i_8094f & i_8092f into the ISaGRAF	11-8
11.3	A simple Motion Example - Using I-8094F Module	11-10
11.3.1	Create an ISaGRAF Motion Project	11-10
11.3.2	Set up I/O connection :	11-21
11.3.3	Compile, Download and execute the project :	11-22
11.4	Descriptions for the Setting of I/O Connection	11-24
11.5	The Motion Control Programming Steps for ISaGRAF	11-29
11.5.1	The Motion Control Steps :	11-29
11.5.2	The I-8092F Example: m92_01 program LD1.....	11-31
11.6	ISaGRAF Function Descriptions	11-37
11.6.1	Notice in using motion functions :	11-37
11.6.2	I-8094F / I-8092F / I-8094 Functions:.....	11-38
	Z_S_RANG : <input checked="" type="checkbox"/> I-8094F <input checked="" type="checkbox"/> I-8092F <input checked="" type="checkbox"/> I-8094	11-38
	Z_S_HOME : <input checked="" type="checkbox"/> I-8094F <input checked="" type="checkbox"/> I-8092F <input checked="" type="checkbox"/> I-8094	11-40
	Z_SRV_ON : <input checked="" type="checkbox"/> I-8094F <input checked="" type="checkbox"/> I-8092F <input checked="" type="checkbox"/> I-8094	11-40
	Z_HOME : <input checked="" type="checkbox"/> I-8094F <input type="checkbox"/> I-8092F <input checked="" type="checkbox"/> I-8094	11-41
	Z_DONE : <input checked="" type="checkbox"/> I-8094F <input checked="" type="checkbox"/> I-8092F <input checked="" type="checkbox"/> I-8094	11-41
	Z_NHO_SH : <input type="checkbox"/> I-8094F <input checked="" type="checkbox"/> I-8092F <input type="checkbox"/> I-8094	11-42
	Z_HOM_SH : <input type="checkbox"/> I-8094F <input checked="" type="checkbox"/> I-8092F <input type="checkbox"/> I-8094	11-42
	Z_PHA_SH : <input type="checkbox"/> I-8094F <input checked="" type="checkbox"/> I-8092F <input type="checkbox"/> I-8094	11-43
	Z_S_ENCO : <input checked="" type="checkbox"/> I-8094F <input checked="" type="checkbox"/> I-8092F <input checked="" type="checkbox"/> I-8094	11-43
	Z_PT : <input checked="" type="checkbox"/> I-8094F <input checked="" type="checkbox"/> I-8092F <input checked="" type="checkbox"/> I-8094	11-44

Z_PT2 :	■ I-8094F ■ I-8092F ■ I-8094	11-45
Z_PT3 :	■ I-8094F □ I-8092F ■ I-8094	11-46
Z_ARC2 :	■ I-8094F ■ I-8092F ■ I-8094	11-47
Z_CON_MV :	■ I-8094F ■ I-8092F ■ I-8094	11-48
Z_VEL_MV :	■ I-8094F ■ I-8092F ■ I-8094	11-48
Z_DRV :	■ I-8094F ■ I-8092F ■ I-8094	11-49
Z_STOP :	■ I-8094F ■ I-8092F ■ I-8094	11-49
Z_MPG :	■ I-8094F ■ I-8092F ■ I-8094	11-50
Z_GET_SP :	■ I-8094F ■ I-8092F ■ I-8094	11-50
Z_GET_AC :	■ I-8094F ■ I-8092F ■ I-8094	11-51
ZC_BEGIN :	■ I-8094F ■ I-8092F ■ I-8094	11-51
ZC_READY :	■ I-8094F ■ I-8092F ■ I-8094	11-52
ZC_END :	■ I-8094F ■ I-8092F ■ I-8094	11-52
ZC_PT2 :	■ I-8094F ■ I-8092F ■ I-8094	11-53
ZC_PT3 :	■ I-8094F □ I-8092F ■ I-8094	11-54
ZC_ARC2 :	■ I-8094F ■ I-8092F ■ I-8094	11-55
11.7	Motion Demo Programs	11-56
11.7.1	The List of ISaGRAF Motion Demos with Soft-GRAF HMI	11-56
11.8	How to Copy One Single Motion Function	11-59
11.9	Error Code List for the Function Return	11-60
APPENDIX A	HARDWARE SYSTEM & SETTING	AP.1
A.1	Applying Correct Power Supply	Ap.1
A.2	Modify The NET-ID & Modbus RTU Port Setting	Ap.2
A.3	Setting The IP Address For The XP-8xx7-CE6	Ap.3
A.4	Connecting PC To The XP-8xx7-CE6 Ethernet Port	Ap.4
A.5	Pin Assignment of COM1~COM5 and Multi-Clients Connection	Ap.5
A.6	Connecting PC To The XP-8xx7-CE6 COM Ports	Ap.6
A.7	Deleting the ISaGRAF Project From XP-8xx7-CE6	Ap.7
A.8	Linking I-7000 and I-87K Modules For Remote I/O	Ap.8
A.9	Linking To An HMI Interface Device	Ap.9
A.10	Linking To Other Modbus Devices	Ap.10
APPENDIX B	UPGRADE XPAC'S ISAGRAF DRIVER TO NEWER VERSION	AP.11
APPENDIX C	DIMENSION	AP.14
APPENDIX D	HOW TO ENABLE/DISABLE XP-8XX7-CE6'S LAN2	AP.17
APPENDIX E	USING EXPANSION RS-232 / 485 / 422	AP.18
APPENDIX F	SLOW DOWN ISAGRAF DRIVER'S SPEED	AP.23
APPENDIX G	SETUP MORE MODBUS RTU SALVE PORTS	AP.24
APPENDIX H	COMPILING ERROR RESULT IN DIFFERENT ISAGRAF VERSION	AP.26
APPENDIX I	USING RS-232 SERIAL/USB TOUCH MONITOR	AP.27
APPENDIX J	WHY MY PC RUNNING ISAGRAF CANNOT CONNECT THE ISAGRAF PAC CORRECTLY ?	28
APPENDIX K	ENABLE THE SCREEN SAVER OF XPAC	AP.29

Reference Guide

ISaGRAF User's Manual (English Manual):

XP-8xx7-CE6 CD: \napdos\isagraf\xp-8xx7-ce6\english-manu\
"user_manual_i_8xx7.pdf" & "user_manual_i_8xx7_Appendix.pdf"
http://www.icpdas.com/products/PAC/i-8000/getting_started_manual.htm

ISaGRAF 進階使用手冊 (Chinese Manual):

XP-8xx7-CE6 CD: \napdos\isagraf\xp-8xx7-ce6\chinese-manu\
"chinese_user_manual_i_8xx7.pdf" & "chinese_user_manual_i_8xx7_Appendix.pdf"
http://www.icpdas.com/products/PAC/i-8000/getting_started_manual.htm

Industrial Ethernet Switch : NS-205/NS-208

http://www.icpdas.com/products/Switch/switch_list.htm



Model: NS-205



Model: NS-208

Power Supply :

http://www.icpdas.com/products/Accessories/power_supply/power_list.htm

DP-660 : 24 V / 2.5 A , 5 V / 0.5 A power supply (DIN-Rail mounting)
DP-665 : 24 V / 2.5 A , 5 V / 0.5 A power supply
DP-1200 : 24 V / 5 A power supply



Model: DP-660



Model: DP-1200



Model: DP-665

FAQ:

www.icpdas.com > FAQ > Software > ISaGRAF for Frequently Asked Questions.
<http://www.icpdas.com/faq/isagraf.htm>

I/O Modules Selection Guide for XP-8xx7-CE6 Series

XP-8xx7-CE6 supports the **I-8K/I-87K High Profile I/O** modules and RS-485 / FRnet remote I/O modules listed in the [ISaGRAF Data Sheet](#) . Please refer to the list in the next page or follow the below steps to get the newest list.

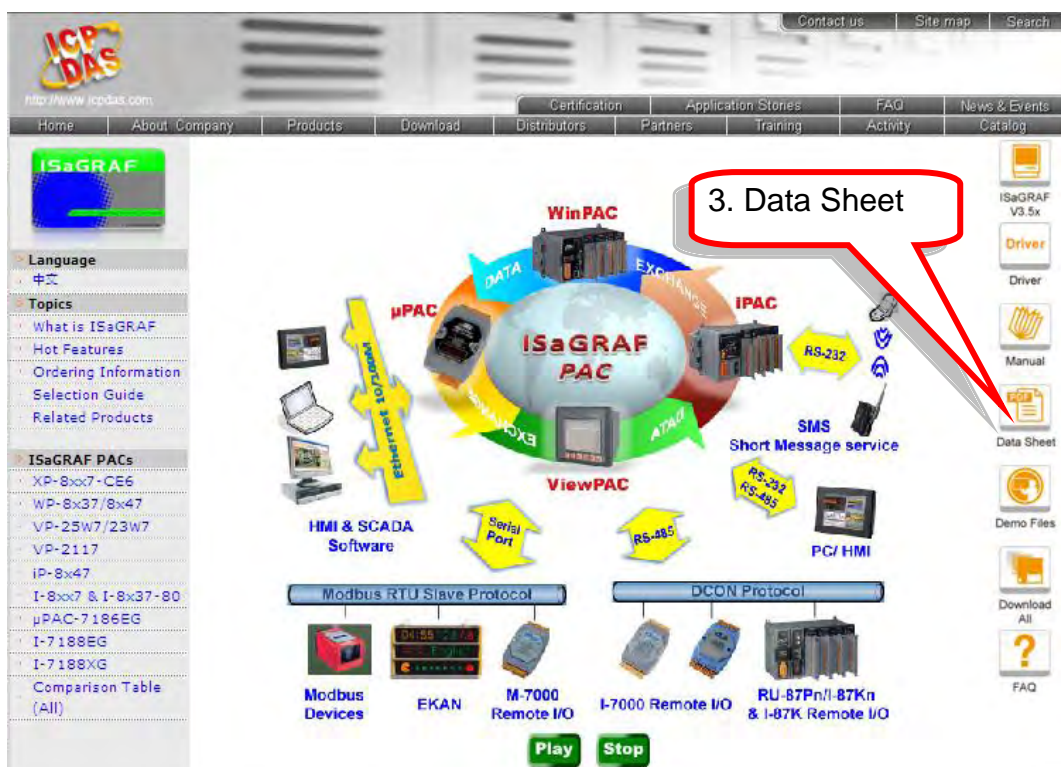

High Speed Local I/O Modules: Parallel Bus

I-8K High Profile Modules: More at www.icpdas.com > Products > PAC - 8K & 87K I/O Modules

I-8K Analog I/O Modules	
I-8014W	16-bit 250K sampling rate 8/16-ch. analog input module (The scan rate cannot reach 250K when using in the ISaGRAF PAC)
I-8017HW	8-ch. Diff. or 16-ch. Single-ended, 14-bit, High Speed Analog Input Module (current input require external 125 Ω resistor) (The scan rate cannot reach 100K when using in the ISaGRAF PAC).
I-8024W	4-ch. Isolated Analog Output Module (+/-10 V, 0 ~ +20 mA)
I-8K Digital I/O Modules	
I-8037W	16-ch. Isolated Open Collector Output Module
I-8040W	32-ch. Isolated Digital Input Module
I-8040PW	32-ch. Isolated Digital Input with Low Pass Filter Module
I-8041W	32-ch. Isolated Open Collector Digital Output Module (Sink)
I-8041AW	32-ch. Isolated Open Collector Digital Output Module (Source)
I-8042W	16-ch. Isolated Digital Input & 16-ch. Isolated Open Collector Digital Output Module
I-8046W	16-ch. Isolated Digital Input Module
I-8050W	16-ch. Universal Digital I/O Module
I-8051W	16-ch. Non-isolated Digital Input Module
I-8052W	8-ch. Differential Isolated Digital Input Module
I-8053W	16-ch. Isolated Digital Input Module
I-8053PW	16-ch. Isolated Digital Input with Low Pass Filter Module
I-8054W	8-ch. Isolated Digital Input Module & 8-ch. Isolated Open Collector Digital Output Module
I-8055W	Non-isolated 8-ch. Digital Logic Input Module & 8-ch. Open Collector Digital Output Module
I-8056W	16-ch. Non-isolated Open Collector Output Module
I-8057W	16-ch. Isolated Open Collector Output Module
I-8058W	8-ch. Differential Isolated Digital Input Module, Max. AC/DC Input : 250V
I-8060W	6-ch. Relay Output Module, AC: 0.6 A @ 125 V , 0.3 A @ 250 V; DC: 2 A @ 30 V
I-8063W	4-ch. Diff. Isolated digital input & 4-ch. Relay output module, AC : 0.6 A @ 125 V ; 0.3 A @ 250 V
I-8064W	8-ch. Power Relay Output Module, AC: 5 A @ 250 V, DC: 5 A @ 30 V
I-8068W	4-ch. Form-A, 5 A @ 250 V _{AC} /28 V _{DC} & 4-ch. Form-C, 5 A (NO) /3 A (NC) @ 277 V _{AC} /30 V _{DC} Relay Output Module
I-8069W	8-ch. PhotoMOS Relay Output Module, Max. AC/DC: 1 A @ 60 V
I-8K Counter/ Frequency Modules	
I-8084W	4/8-ch. Counter/Frequency Module, Isolated or TTL level. (Can measure 4-ch Encoder without Z-index)
I-8088W	8-ch. PWM Output and 8-ch. isolated DI Module, software support 1 Hz ~ 100 kHz (non-continuous)

I-8K Motion Modules	
I-8093W	3-axis Encoder Module, max. 1M Hz for quadrant input mode, max. 4M Hz for pulse/direction and cw/ccw input model
I-8090W	3-axis Encoder Module
I-8091W	2-axis Stepping/Servo Motor Control Card without encoder input
I-8092F	High Speed 4-axis Motion Control Module with FRnet master
I-8094F	High Speed 4-axis Motion Control Module with FRnet master
I-8094	High Speed 4-axis Motion Control Module
I-8K Communication Modules	
I-8112iW	2-ch. isolated RS-232 expansion module
I-8114W	4-ch. non-isolated RS-232 expansion module
I-8114iW	4-ch. isolated RS-232 expansion module
I-8142iW	2-ch. isolated RS-422/485 expansion module
I-8144iW	4-ch. isolated RS-422/485 expansion module
I-8172W	2-port FRnet module

RS-485 Remote I/O Modules: Serial Interface; HOT-SWAP

I-87K High Profile Modules: More at www.icpdas.com > Products > PAC - 8K & 87K I/O Modules

I-87K Analog I/O Modules	
I-87005W	8-ch. Thermistor input and 8-ch. digital output module
I-87013W	4-ch. , 16-bit, 10 Hz (Total), 2/3/4 Wire RTD Input Module with Open Wire Detection
I-87015W	7-ch. , 16-bit, 12 Hz (Total), RTD Input Module with Open Wire Detection (for short sensor distance)
I-87015PW	7-ch. RTD Input Module with 3-wire RTD lead resistance elimination and with Open Wire Detection (for long sensor distance)
I-87017RW	8-ch. Differential , 16/12-bit, 10/60 Hz (Total) Analog Input Module with 240 V _{rms} Over Voltage Protection, Range of -20 ~ +20 mA Requires Optional External 125 Ω Resistor
I-87017RCW	8-ch. Differential , 16/12-bit, 10/60 Hz(Total) Current Input Module
I-87017W	8-ch. Analog Input Module
I-87017W-A5	8-ch. High Voltage Input Module
I-87018RW	8-ch. Thermocouple Input Module. Recommend to use the better I-87018ZW.
I-87018W	8-ch. Thermocouple Input Module. Recommend to use the better I-87018ZW.
I-87018ZW	10-ch. Differential , 16-bit, 10 Hz (Total), Thermocouple Input Module with 240 V _{rms} Over Voltage Protection, Open Wire Detection, Range of +/-20 mA, 0~20 mA, 4~20 mA requires Optional External 125 Ω Resistor
I-87019RW	8-ch. Diff. , 16-bit, 8 Hz (Total), Universal Analog Input Module with 240 V _{rms} Over Voltage Protection, Open Wire Detection (V, mA, Thermocouple; Range of -20 ~ +20 mA need to set Jumper on board)
I-87024CW	4-ch. 12-bit channel to channel isolated current output module with open-wire detection

I-87024W	4-ch. 14-bit analog output module (0 ~ +5 V, +/-5 V, 0 ~ +10 V, +/-10 V, 0 ~ +20 mA, +4 ~ +20 mA)
I-87028CW	8-ch. 12-bit current output module
I-87K Digital I/O Modules	
I-87040W	32-ch. Isolated Digital Input Module
I-87041W	32-ch. Sink Type Open Collector Isolated Digital Output Module
I-87046W	16-ch. Non-Isolated Digital Input Module for Long Distance Measurement
I-87051W	16-ch. Non-Isolated Digital Input Module
I-87052W	8-ch. Differential , Isolated Digital Input Module
I-87053PW	16-ch. Isolated Digital Input Module with 16-bit Counters
I-87053W	16-ch. Isolated Digital Input Module
I-87053W-A5	16-ch. 68 ~ 150 V _{DC} Isolated Digital Input Module
I-87054W	Isolated 8-ch. DI and 8-ch. Open Collector DO Module
I-87055W	Non-Isolated 8-ch. DI and 8-ch. Open Collector DO Module
I-87057W	16-ch. Open Collector Isolated Digital Output Module
I-87058W	8-ch. 80~250 V _{AC} Isolated Digital Input Module
I-87059W	8-ch. Differential 10-80 V _{AC} Isolated Digital Input Module
I-87061W	16-ch. Relay Output Module (RoHS)
I-87063W	4-ch. Differential Isolated Digital Input and 4-ch. Relay Output Module. 5 A (NO) / 3 A(NC) @ 5 ~ 24 V _{DC} ; 5 A(NO) / 3 A(NC) @ 0 ~ 250 V _{AC}
I-87064W	8-ch. Relay Output Module, 5 A (47~63 Hz) @ 0~ 250 V _{AC} ; 5 A @ 0~ 30 V _{DC}
I-87065W	8-ch. AC SSR Output Module, AC: 1.0 A _{rms} @ 24 ~ 265 V _{rms}
I-87066W	8-ch. DC SSR Output Module , DC: 1.0 A _{rms} @ 3 ~ 30 V _{DC}
I-87068W	4-ch. Form-A Relay Output and 4-ch. Form-C Relay Output Module. Form-A: 8 A @ 250 V _{AC} ; 8 A @ 28 V _{DC} . Form-C: 5 A (NO) / 3 A (NC) @ 277 V _{AC} ; 5 A(NO) / 3 A(NC) @ 30 V _{AC}
I-87069W	8-ch. PhotoMOS Relay Output Module, Max. AC/DC: 0.13 A @ 350 V
I-87K Counter/Frequency Modules	
I-87082W	2-ch. Counter/Frequency Module, Isolated or Non-isolated Inputs
I-87084W	4-ch. Counter/Frequency/Encoder Module, Isolated or Non-isolated Inputs
I-87K PWM Module	
I-87088W	8-ch. PWM outputs, software support 1 Hz ~ 100 KHz, (non-continuous), duty: 0.1 ~ 99.9%
I-87K GPS Module	
I-87211W	Time-Synchronization and GPS module for getting UTC/local time and local Longitude/Latitude

RS-485 Remote I/O Modules	
I-7000	 Products > Remote I/O Modules/Units > I-7000 Modules > Selection Guide">www.icpdas.com > Products > Remote I/O Modules/Units > I-7000 Modules > Selection Guide
M-7000	 Products > Remote I/O Modules/Units > M-7000 Modules > Selection Guide">www.icpdas.com > Products > Remote I/O Modules/Units > M-7000 Modules > Selection Guide

RS-485 Remote Hot-Swap Expansion Unit	
RU-87P1/2/4/8	www.icpdas.com > Products > Remote I/O Modules/Units > Remote I/O Expansion Unit > Selection Guide
RS-485 Remote Expansion Unit	
I-87K1/4/5/8/9	www.icpdas.com > Products > Remote I/O Modules/Units > Remote I/O Expansion Unit > Selection Guide

Performance Comparison Table of ISaGRAF PACs

Please click on the link [ISaGRAF Comparison Table](#) or follow the below steps:

The screenshot shows the ICP DAS website homepage. A red callout box highlights the address bar containing the URL "1. www.icpdas.com". The website features a navigation menu with options like Home, About Company, Products, Download, and more. The main content area displays the "ViewPAC Family" as "The All-in-One Control Unit" with features like Touch Screen, Programmable Keypads, and Optional Operation System. A sidebar on the right lists various products such as Industrial Fiber Switch, VXC Card, and PDS. A second red callout box points to a link in the bottom left corner labeled "2. Click here to go to the ISaGRAF page".

The screenshot shows the ISaGRAF product page. The main content area features a central diagram of the "ISaGRAF PAC" system, showing connections to WinPAC, IPAC, ViewPAC, and various protocols like Modbus RTU Slave Protocol and DCON Protocol. The diagram also includes icons for HMI & SCADA Software, Serial Port, RS-485, and PC/HMI. A sidebar on the left lists "ISaGRAF PACs" with models like XP-8xx7-CE6, WP-8x37/8x47, and others. A "Comparison Table" link is highlighted with a red callout box labeled "3. Comparison Table". The right sidebar contains links for ISaGRAF V3.5x, Driver, Manual, Data Sheet, Demo Files, Download All, and FAQ.

Specifications: XP-8047-CE6/ 8347-CE6/ 8747-CE6

Models	XP-8047-CE6	XP-8347-CE6	XP-8747-CE6
■ System Software			
OS	Microsoft Windows Embedded CE 6.0		
.Net Compact Framework	3.5		
Embedded Service	FTP server, Web server		
■ Development Software			
ISaGRAF Software	ISaGRAF Version 3 : IEC 61131-3 standard. Languages: LD, ST, FBD, SFC, IL & FC Support Soft-GRAF HMI: XP-8xx7-CE6, WP-8xx7 & VP-2xW7 PAC		
Max. Code Size	Accept max. 2 MB ISaGRAF code size (Appli.x8m must < 2 MB)		
Non-ISaGRAF	Options: Microsoft EVC++ 4.0 or VS.NET 2003/2005/2008 (VB.NET2003/2005/2008, C#.NET 2003/2005/2008) with .Net Compact Framework 3.5		
■ Web Service			
Web HMI	Support Web HMI function, PC running Internet Explorer can access to the XP-8xx7-CE6 via local Ethernet, Internet or dial Modem to monitor and control.		
Security	Web HMI supports three levels username and password protection. (high/middle/low)		
■ Power Supply			
Input Range	+10 ~ +30 V _{DC} (unregulated),		
Isolation	1 kV		
Redundant Power Inputs	Yes, with one power relay (1 A @ 24 V _{DC}) for alarm		
Capacity	1.8 A, 5 V supply to CPU and backplane; total 15 W	1.8 A, 5 V supply to CPU and backplane; 5.2 A, 5 V supply to I/O expansion slots, total 35 W	2.0 A, 5 V supply to CPU and backplane; 5.0 A, 5 V supply to I/O expansion slots, total 35 W
Consumption	14.4 W (0.6 A @ 24 V _{DC})	14.4 W (0.6 A @ 24 V _{DC})	16.8 W (0.7 A @ 24 V _{DC})
■ General Environment			
Temperature	Operating Temperature: -25 ~ +75 °C; Storage Temperature: -30 ~ +85 °C		
Humidity	5 ~ 90% RH, non-condensing		
■ System			
CPU	AMD LX 800 processor (32-bit & 500 MHz) or compatible		
System Memory	512 MB DDR SDRAM		
Dual Battery Backup SRAM	512 KB (for 5 years data retain while power off)		
FLASH	4 GB as IDE Master		
EEPROM	16 KB; Data retention: 40 years. 1,000,000 erase/write cycles		
CF Card	1 GB (support up to 32 GB, CE6.0)		

Models	XP-8047-CE6	XP-8347-CE6	XP-8747-CE6
Hardware Serial Number	Yes, 64-bit hardware unique serial number		
RTC (Real Time Clock)	Provide second, minute, hour, date, day of week, month, year		
Dual WDT	Yes, Dual Watchdog Timers		
Rotary Switch	Yes (0~9)		
DIP Switch	No	Yes, 8 bits DIP Switch	
NET ID	1~255, user-assigned by software		
■ VGA & Communication Ports			
VGA	Yes (resolution: 1600 x 1200, 1024 x 768, 800 x 600, 640 x480)		
Ethernet	RJ-45 x 2, 10/100 Base-TX (Auto-negotiating, Auto MDI/MDI-X, LED indicators) Please use NS-205/NS-208 Industrial Ethernet Switch.		
USB 2.0	2		
COM1	RS-232 (RxD, TxD and GND); non-isolated	Internal communication with I-87K modules in slots	
COM2	RS-232 (RxD, TxD and GND); non-isolated		
COM3	RS-485 (D2+, D2-); self-tuner ASIC inside; Isolation: 3000 V_{DC} ;		
COM4	RS-232/RS-485 (RxD, TxD, CTS, RTS and GND for RS-232, Data+ and Data- for RS-485); non-isolated		
COM5	RS-232 (RxD, TxD, CTS, RTS, DSR, DTR, CD, RI and GND); non-isolated		
■ I/O Expansion Slots			
Slot Number	0 slot	3 slots (slot1 ~ 3)	7 slots (slot1 ~ 7)
Hot Swap	-	For high profile I-87K modules only	
■ Mechanical			
Dimensions (W x L x H)	137 mm x 132 mm x 125 mm	231 mm x 132 mm x 125 mm	355 mm x 132 mm x 125 mm
Installation	DIN-Rail or Wall Mounting		
■ Motion			
Motion Control	No	Integrate with one or serval I-8092F (2-axis) or I-8094F/I-8094 (4-axis)	
■ PWM Output			
High Speed PWM Module	I-7088, I-8088W, I-87088W: 8-ch. PWM outputs, software support 1Hz~100KHz (non-continuous), duty: 0.1 ~ 99.9%		
DO Module as PWM	8-ch max. 250 Hz max. For Off=2 & On=2 ms. Output square wave: Off: 2~32766 ms, On: 2 ~ 32766 ms. Optional DO Boards: I-8037W, 8041W, 8041AW, 8042W, 8050W, 8054W, 8055W, 8056W, 8057W, 8060W, 8063W, 8064W, 8068W, 8069W (Relay Output boards can not generate fast square wave.)		
■ Counter, Encoder, Frequency			
Parallel DI Counter	8 ch. max. for 1 controller. Counter val: 32 bit. 250 Hz max. Min. ON & OFF width must > 2 ms.		

Models	XP-8047-CE6	XP-8347-CE6	XP-8747-CE6
	Optional DI Boards: I-8040W, 8040PW, 8042W, 8048W, 8050W, 8051W, 8052W, 8053W, 8053PW, 8054W, 8055W, 8058W, 8063W.		
Serial DI Counter	Counter input: 100 Hz max. Counter value: 0 ~ 65535 (16 bit) Optional Serial I-87K DI Boards: I-87040W, 87046W, 87051W, 87052W, 87053W, 87053W-A5, 87054W, 87055W, 87058W, 87059W, 87063W.		
Remote DI Counter	All remote I-7000 & I-87K DI modules support counters. 100 Hz max. value: 0 ~ 65535		
High Speed Counter	I-87082W: 100 kHz max. 32 bit; I-8084W: 250 kHz max. 32 bit		
Encoder	I-8093W : 3-axis Encoder Module, max. 1M Hz for quadrant input mode, max. 4 MHz for pulse/direction and cw/ccw input mode. (FAQ-112) I-8084W: 250 kHz max. , 4-ch encoder, can be pulse/direction, or up/down or A/B phase (Quad. mode), No support Encoder Z-index. (FAQ-100)		
Frequency	I-87082W: 2-ch, 1 Hz ~ 100 kHz; I-8084W: 8-ch, 1 Hz ~ 250 kHz;		
■ Protocols			
Modbus TCP Master	Link to max. 100 devices that support Standard Modbus TCP/IP Slave protocol (FAQ-113)		
Modbus RTU/ ASCII Master (Multi-Port)	Max. 33 COM Ports (COM1 ~ 5 and <u>COM6 ~ 33 if multi-serial port boards are plugged in slot1~7</u>) can support multi-ports of Modbus RTU/ASCII Master protocol to connect to other Modbus Slave devices. (XP-8347-CE6/8747-CE6's COM1 is for internal communication with I-87K modules in slots only.)		
Modbus RTU Slave	Max. 9 COM Ports (COM1 ~ 33) can support Modbus RTU Slave protocol for connecting ISaGRAF, PC/HMI/OPC Server & HMI panels. (XP-8347-CE6/8747-CE6's COM1 is for internal communication with I-87K modules in slots only.)		
Modbus TCP/IP Slave	2 Ethernet Ports all support Modbus TCP/IP Slave protocol for connecting ISaGRAF & PC/HMI. 2 Ports support up to 64 connections. (If PAC uses 1 connection to connect each PC/HMI, it can connect up to 64 PC/HMI; If PAC uses 2 connections to connect each PC/HMI, it can connect up to 32 PC/HMI; ...) When one Ethernet port is broken, the other one can still connect to PC/HMI.		
Web HMI	Ethernet Ports for connecting PC running Internet Explorer		
I-7000 & I-87K RS-485 Remote I/O	One of COM3~4 supports <u>I-7000 I/O modules, I-87K base + I-87K Serial I/O boards or RU-87Pn + I-87K High Profile I/O boards</u> as remote I/O. Max. 255 modules of I-7000/87K Remote I/O for one PAC.		
M-7000 Series Modbus I/O	Max. 33 RS-485 ports (COM1 ~ 5 & <u>COM6 ~33 if multi-serial port boards are plugged in</u>) can support M-7000 series Modbus I/O. Each port can connect up to 32 M-7000 Modules. (XP-8347-CE6 / 8747-CE6's COM1 is for internal communication with I-87K modules in slots only)		
Modbus TCP/IP I/O	LAN2 supports ICP DAS Ethernet I/O : I-8KE4-MTCP and I-8KE8-MTCP (listed at FAQ-042) If LAN2 is broken, it will switch to LAN1 automatically to continuously work. (This need LAN1 & LAN2's IP are set in the same IP domain)		
FRnet I/O	Support max 7 pcs. I-8172W boards in slot 1 ~ 7 to connect to FRnet I/O modules, like FR-2053, FR-2057 FR-32R, FR-32P. (FAQ-048)		

Models	XP-8047-CE6	XP-8347-CE6	XP-8747-CE6
	Each I-8172W board can link max. 256 DI plus 256 DO ch.		
Send E-mail	Supports mail_snd and mail_set functions to send email with one attached file via Ethernet port.		
Ebus	To exchange data between ICP DAS's ISaGRAF Ethernet PACs via Ethernet port. (LAN2 Port only)		
SMS: Short Message Service	COM4 or COM5 can link to a GSM Modem to support SMS. User can request data/control the controller by cellular phone. The controller can also send data & alarms to user's cellular phone. Optional GSM Modems: GTM-201-RS232 (External Modem: 850/900/1800/1900 GSM/GPRS)		
User-Defined Protocol	User can write his own protocol applied at <u>COM1~COM5 & COM6~COM33</u> (if multi-serial port boards are plugged in) by Serial communication function blocks. (XP-8347-CE6 / 8747-CE6's COM1 is for internal communication with I-87K modules in slots only)		
MMICON/LCD	<u>COM4</u> or <u>COM5</u> supports ICP DAS's MMICON. The MMICON is featured with a 240 x 64 dot LCD & a 4 x 4 Keyboard to display picture, string, integer, float, & input a char, string, integer & float.		
UDP Server & UDP Client : Exchange Message & Auto-Report	LAN1 or LAN2 support UDP Server and UDP Client protocol to send/receive message to / from PC/HMI or other devices. For example, to automatically report data to InduSoft's RXTX driver.		
TCP Client : Exchange Message & Auto-Report	LAN1 or LAN2 support TCP Client protocol to send / receive message to / from PC/HMI or other devices which support TCP server protocol. For example, to automatically report data to InduSoft's RXTX driver, or to connect a local camera.		
New Hot-Swap and Redundant System	This redundant system has setup two "Active IP" address point to the active LAN1 and LAN2 ports always. One or more PC/HMI/SCADA can communicate with this redundant system via one of the two given active IP. So the PC/HMI/SCADA can access to the system easily without any notice about which PAC is currently active. Moreover, the new redundant system can integrate with the RU-87P4/87P8 Expansion Unit plus the I-87K high-profile I/O cards to support the hot-swap application. If the I/O card is damaged, the maintenance person just takes one good-card with same model number to hot-swap the damaged one without stopping this redundant system. (FAQ-093)		
CAN/ CANopen	<u>COM1, 2, 4, 5 or COM6~COM33</u> resides at the <u>I-8112iW/ 8114W/ 8114iW RS-232 expansion board</u> to connect one I-7530 (converter: RS-232 to CAN) to support CAN/CANopen devices and sensors. One PAC supports max. 32 RS-232 ports to connect max. 32 I-7530. (FAQ-086) (XP-8347-CE6 / 8747-CE6's COM1 is for internal communication with I-87K modules in slots only)		

Chapter 1 Typical Application

The website for the applications supporting list of all ISaGRAF PACs :
http://www.icpdas.com/products/PAC/common_file/application-notes.htm

1.1 Motion Control : Using I-8094F/8092F/8094

- XP-8xx7-CE6 plus I-8094F/8092F/8094 motion modules with daughter boards
- ISaGRAF + Soft-GRAF: User can achieve motion control, HMI design and I/O control within the ISaGRAF software.
- I-8094 is a 4-axis high speed motion control module.
- I-8094F (4-axis) and I-8092F (2-axis) are high speed motion control modules with FRnet master.
- More at www.icpdas.com > FAQ > Software > ISaGRAF Ver.3 (English) – FAQ-132.



1.2 Soft-GRAF HMI : Create A Colorful HMI

- All-in-one: Design the control logic and HMI by single ISaGRAF software.
- Support various and colorful HMI objects:
 - Page (Max. 200, support password security)
 - Numeric (Input, input security, display)
 - Text (Dynamic/static text display)
 - Picture (Animated/static picture display)
 - Moving Trace (1-axis or 2-axis)
 - Built-in various objects
- Multi-language: English, Traditional Chinese, Simplify Chinese, etc.
- HMI behave smoothly

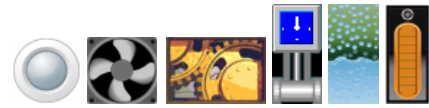

More at:
Chapter 2.5 & FAQ
www.icpdas.com > FAQ
> Software > ISaGRAF
Ver.3 – FAQ-131

1.3 eLogger HMI Application

- ICP DAS eLogger is an easy and useful HMI development tool which helps user to create user-friendly pictures and control items.
- More at: www.icpdas.com > FAQ > Software > ISaGRAF > FAQ-115.

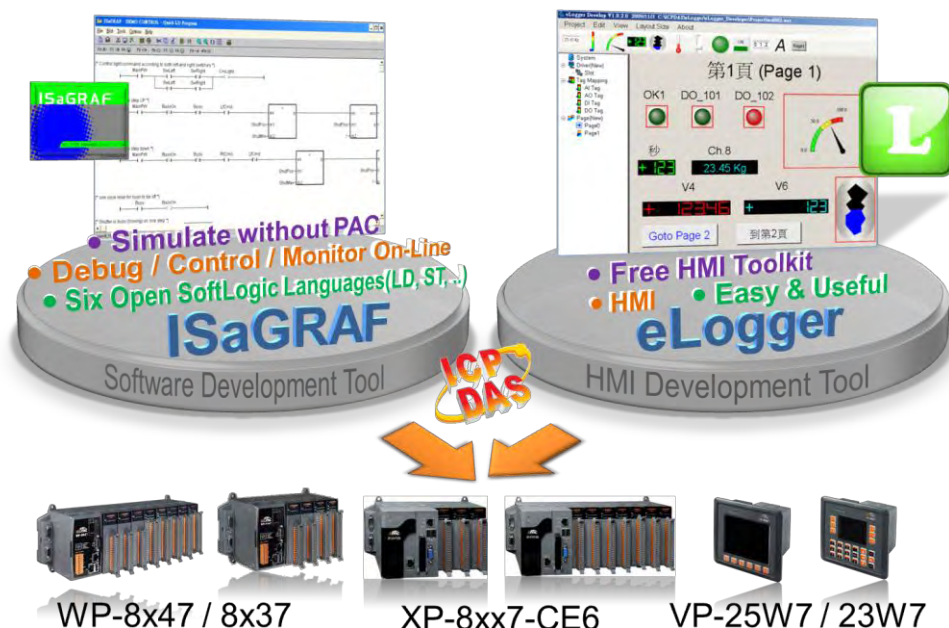

1.4 Connect the Smart Power Meter PM-2133/2134

- ISaGRAF PAC support standard Modbus protocol, support multiple RS-485 ports to connect to multiple PM-213x Smart meters.
- For the power measurement control systems in small/medium sized stores, buildings and factories with electric equipments.
- PM-213x smart meter with "Wh" pulse output is useful in the systems needing to connect the meter tester.
- PM-213x smart meter with wired clip-on CT is easily wiring for on-line installation, suitable for the uninterruptible power systems.
- PM-213x is a series of 3 Phase/4 Loops 1 Phase Compact Smart Meter with true RMS energy and power parameters measurement in compact size. The ISaGRAF PACs combining with PM-213x can apply to various control/monitor systems about intelligent electric power measurement.
- More at www.icpdas.com > FAQ > Software > ISaGRAF Ver.3 (English) - 129.



1.5 Redundant Communication System

- Please refer to www.icpdas.com > FAQ > Software > ISaGRAF > FAQ-119 for more information about RS-485 and Ethernet redundant communication mechanism and applications.

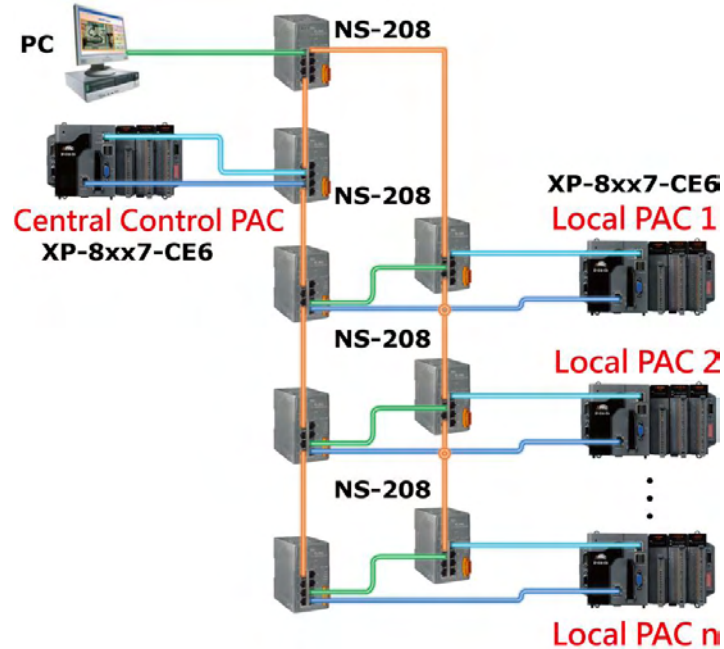

1.6 Redundant System - Ethernet I/O

- If one Ethernet cable is broken or damaged, the other one will still handle the Ethernet I/O and exchange data with the other redundant controller.
- The scan of Ethernet I/O is much faster than that of RS-485 I-7000/I-87K I/O.
- More at www.icpdas.com > FAQ > Software > ISaGRAF Ver.3 (English) - 125

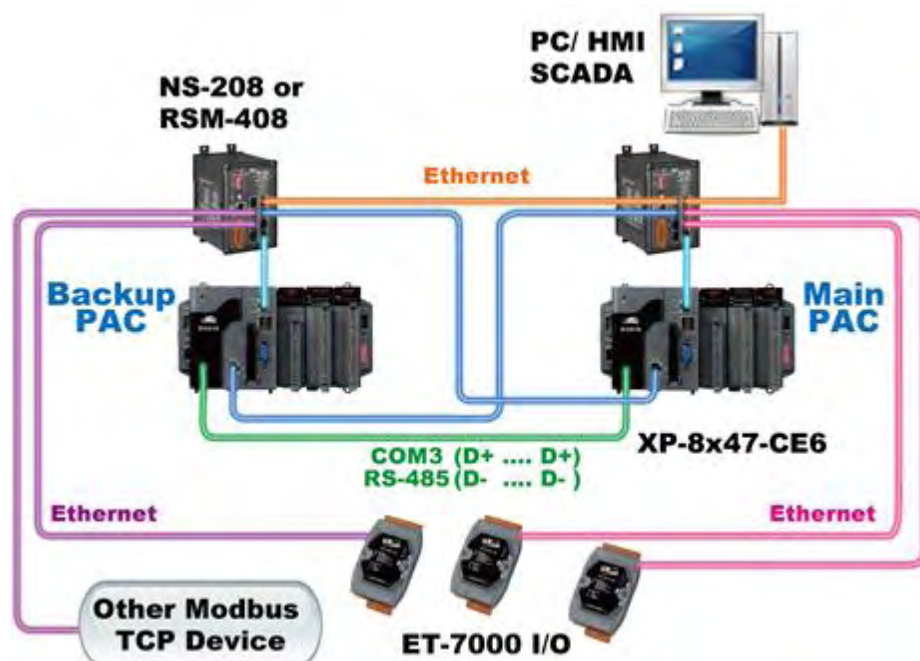

1.7 Redundant System – Hot-Swap RS-485 I/O

- If one Ethernet cable of PAC is broken or damaged, the other one will still work. If one controller is dead, the other one will take over the control of the RS-485 I/O.
- PC/HMI can connect to this redundant system by one or two active IP.
- More at www.icpdas.com > FAQ > Software > ISaGRAF Ver.3 - 093

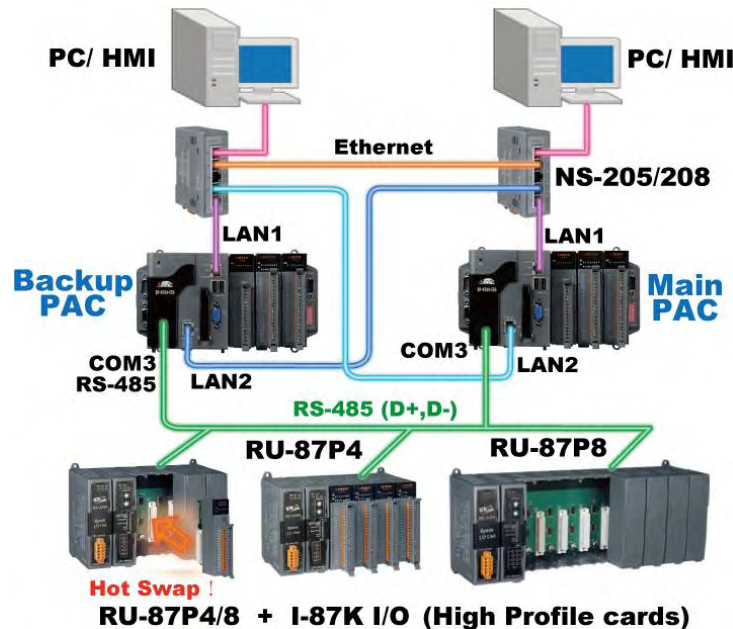

1.8 Redundant System – with iDCS-8000

- Dual PACs, dual Ethernet ports redundant system
- PC/HMI can just connect one IP address to link to the redundant system. If the active PAC is damaged, it will take about 0.5 seconds to switch to the other PAC.
- More at www.icpdas.com > FAQ > Software > ISaGRAF Ver.3 – 125

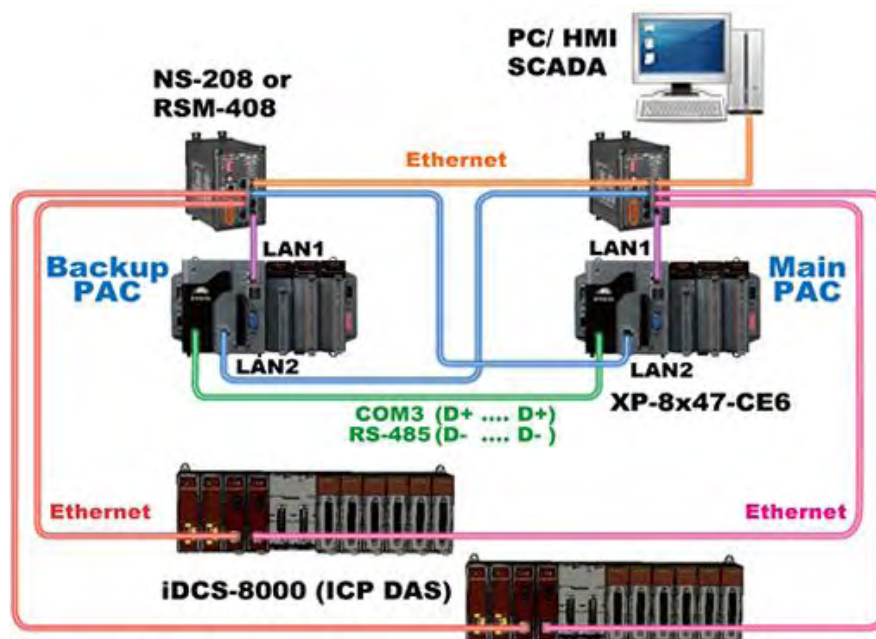

1.9 Modbus Master: TCP/IP

- Each XP-8xx7-CE6, WP-8xx7 or VP-25W7/23W7 supports to link to max. 100 Modbus TCP/IP slave devices.
- Support various Standard Modbus TCP/IP Slave devices.
- More at: www.icpdas.com > FAQ > Software > ISaGRAF Ver.3 (English) > 113

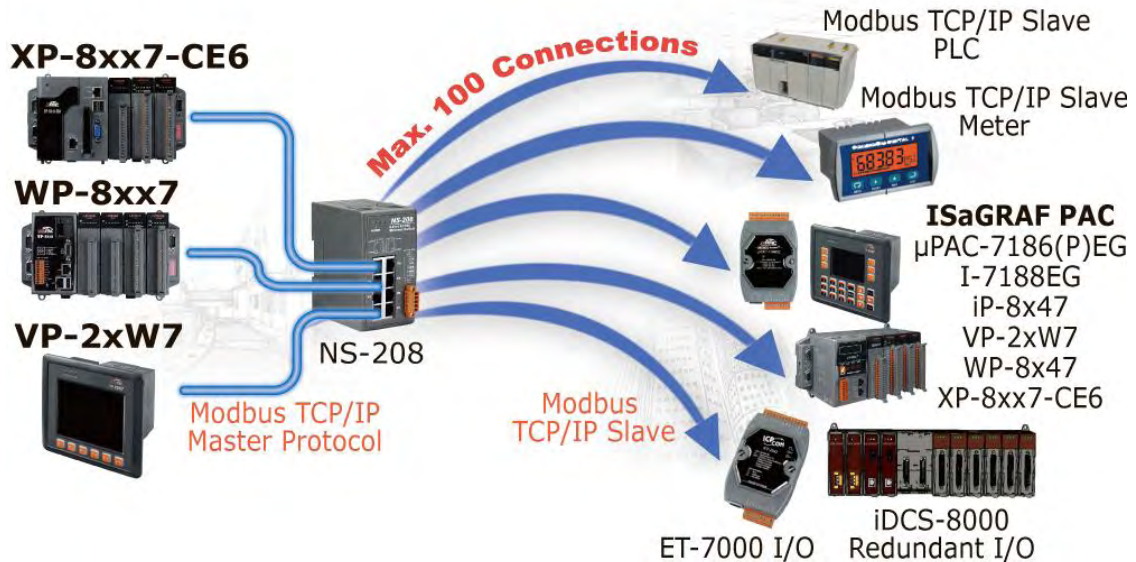

1.10 Modbus Master: RTU, ASCII, RS-232/485/422

- Support up to 33 ports:
COM1~COM5 (only XP-8047-CE6 can use COM1 as Modbus Master)
COM6~COM33 (if I-8112iW/ 14W/ 14iW/ 42iW/ 44iW in Slot1~7)
- Note: XP-8347-CE6 / 8747-CE6's COM1 is for internal communication with I-87K modules in slots only.
- Can link to Modbus PLC or M-7000 I/O or Modbus devices (Power meter, temperature controller, inverter etc.)

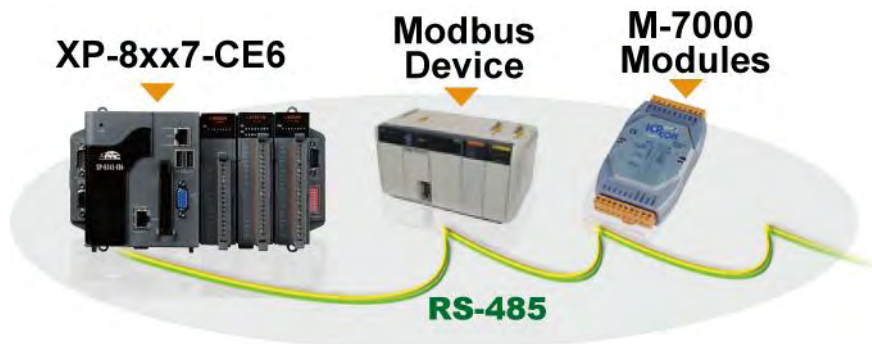

1.11 Modbus Slave: RTU/TCP

- Modbus RTU Slave (RS-232/485/422): max. 9 ports
- Modbus TCP/IP Slave : max. 64 connections



1.12 Communicate With Other TCP/IP Server or UDP Client/Server Devices

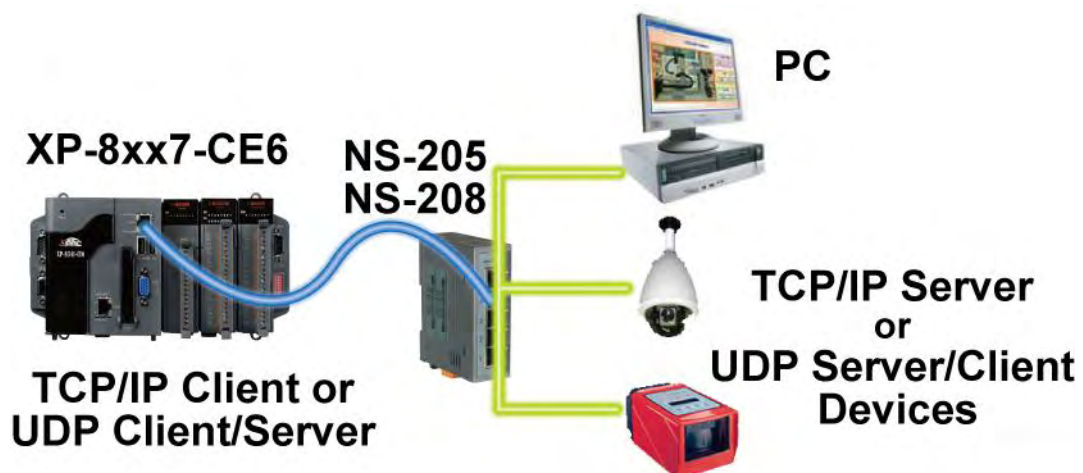

1.13 Multiple Web HMI – Monitor & Control Everywhere!

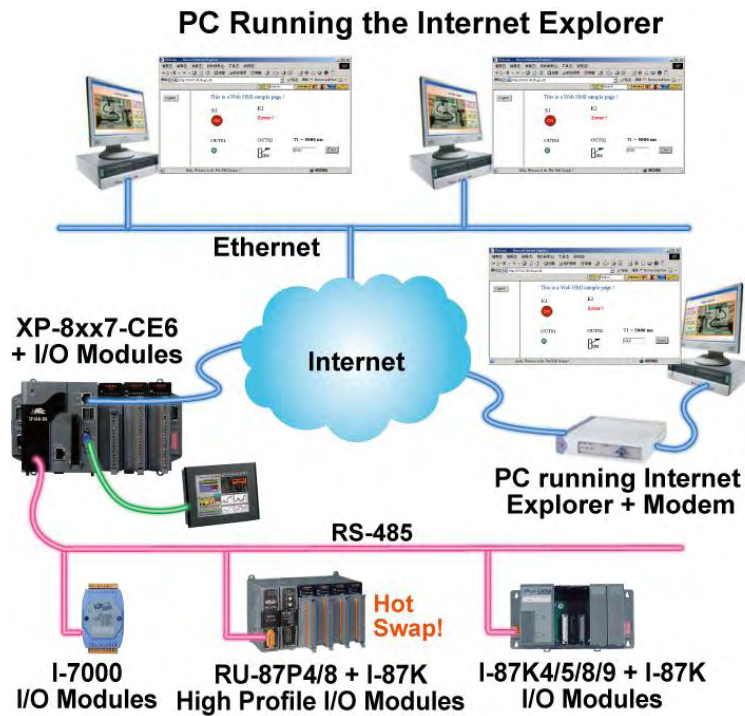

1.14 Send Email With or Without One Attached File

- More at www.icpdas.com > FAQ > Software > ISaGRAF Ver.3 (English) - 067



1.15 Data-Recorder & Data-Logger

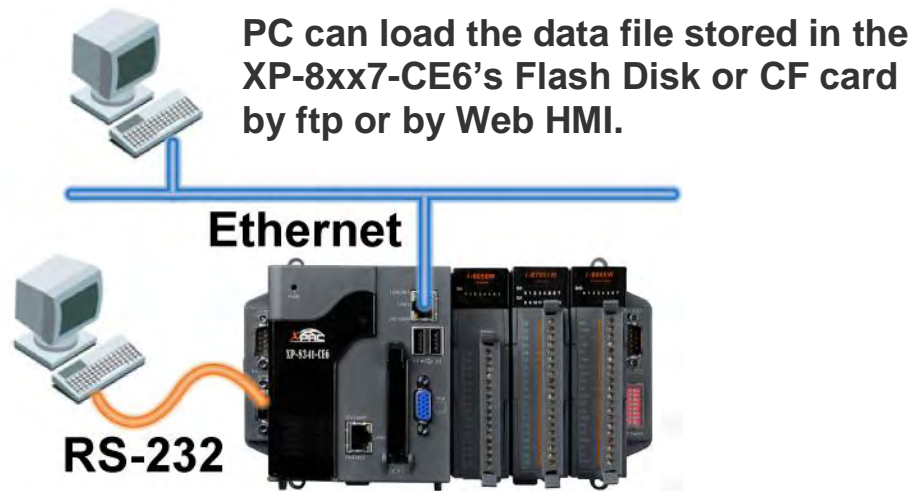

1.16 Remote I/O Application

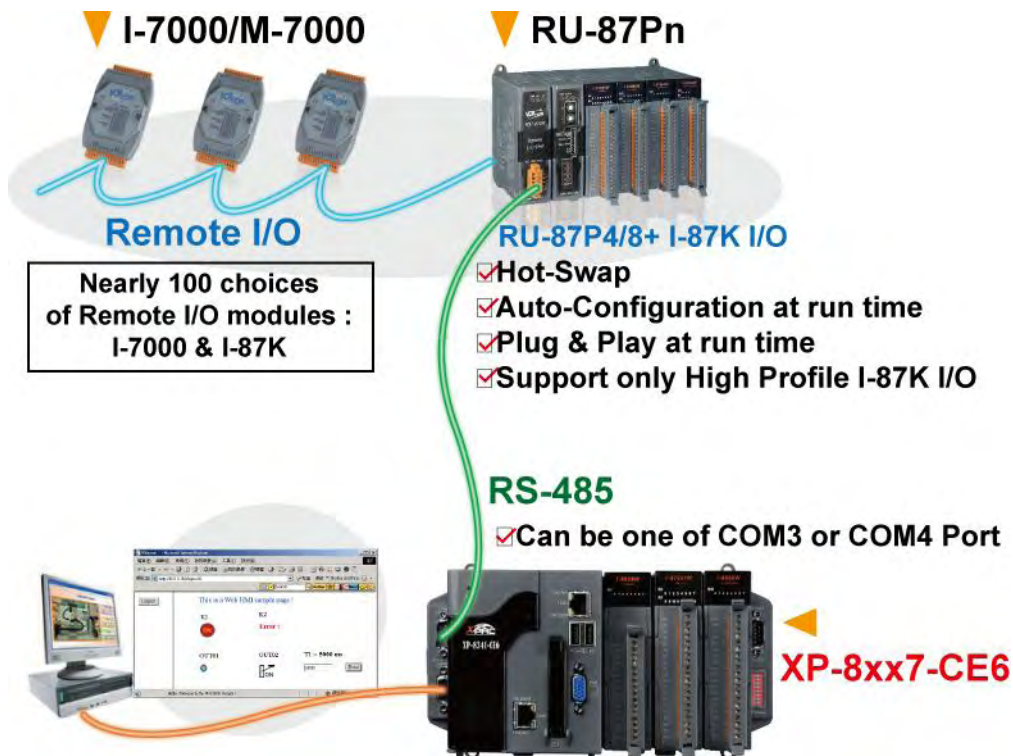

1.17 SMS: Short Message Service

- Short message can be sent in multiple language format (like Chinese, English... others)
- More at www.icpdas.com > FAQ > Software > ISaGRAF Ver.3 (English) - 111

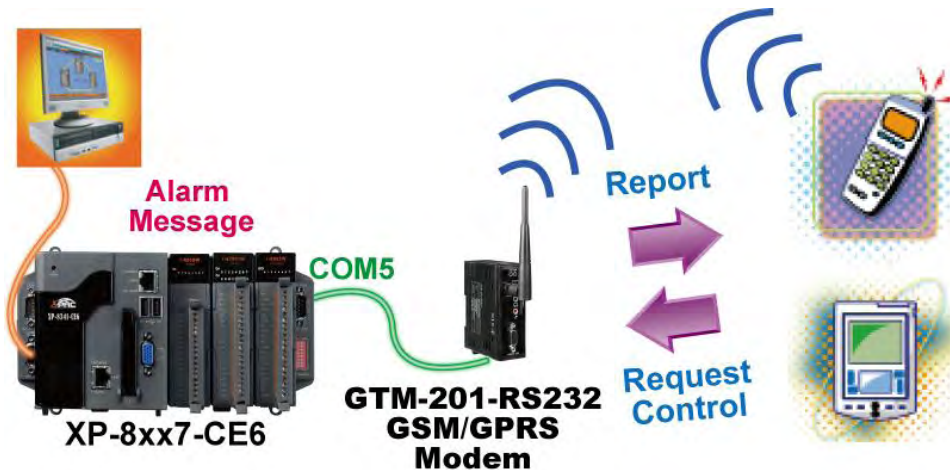

1.18 Auto-report Acquisition & Control Data

- XP-8xx7-CE6 can use UDP IP Client to auto-report acquisition data & control data to local or remote internet PC/Server.
- Advantage: Every PAC in the different location doesn't need a fixed Internet IP
- More at www.icpdas.com > FAQ > Software > ISaGRAF Ver.3 (English) - 065

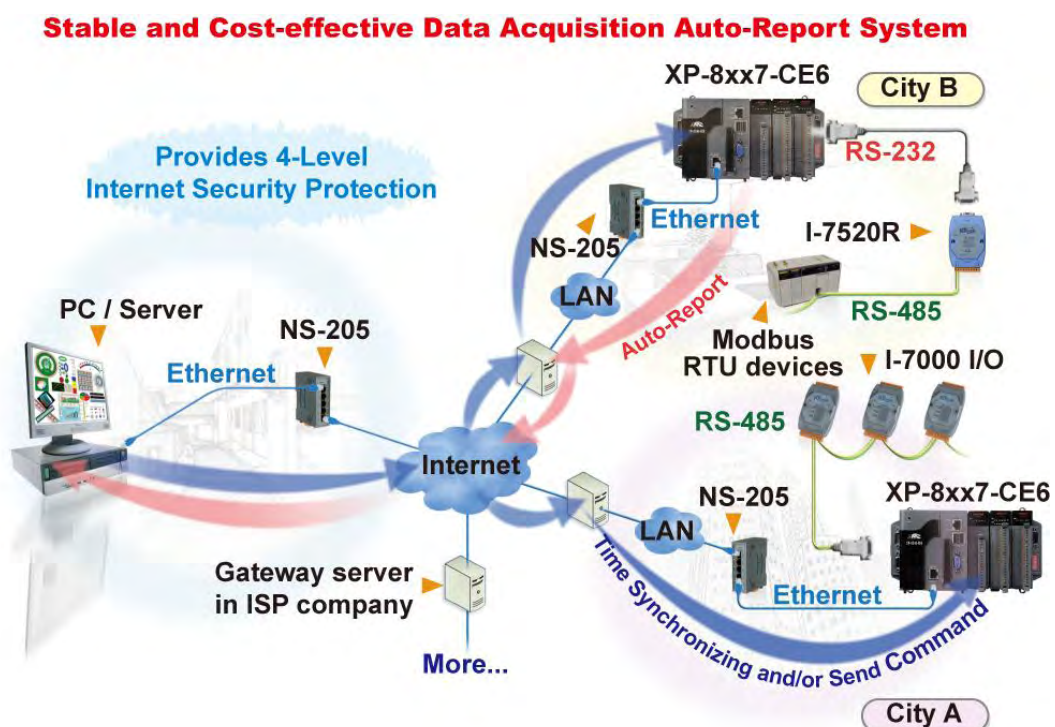

1.19 Stress Monitoring Application of Constructions

- ICP DAS releases effective "VW Sensor" (Vibration Wire solution) and "Carlson Strain Gauge Inputs" solution . It's useful for measuring the stress of constructions like building, bridge, dam, etc.
- Each ISaGRAF PAC (as FAQ-091) supports the I-87089 (the VW master card) plus the DN-1618UB (daughter board) to achieve the "VW Sensor" application.
- Each XP-8xx7-CE6, WP-8xx7 or VP-25W7/23W7 supports the I-87113DW module (the master card of Carlson Strain Gauge Inputs) plus the DN-1619 (DN-1618U-Test1) (daughter board) to achieve the "Carlson Strain Gauge Inputs" application.
- Please click www.icpdas.com > FAQ > Software > ISaGRAF Ver.3 (English) - 091, 128 for more information.

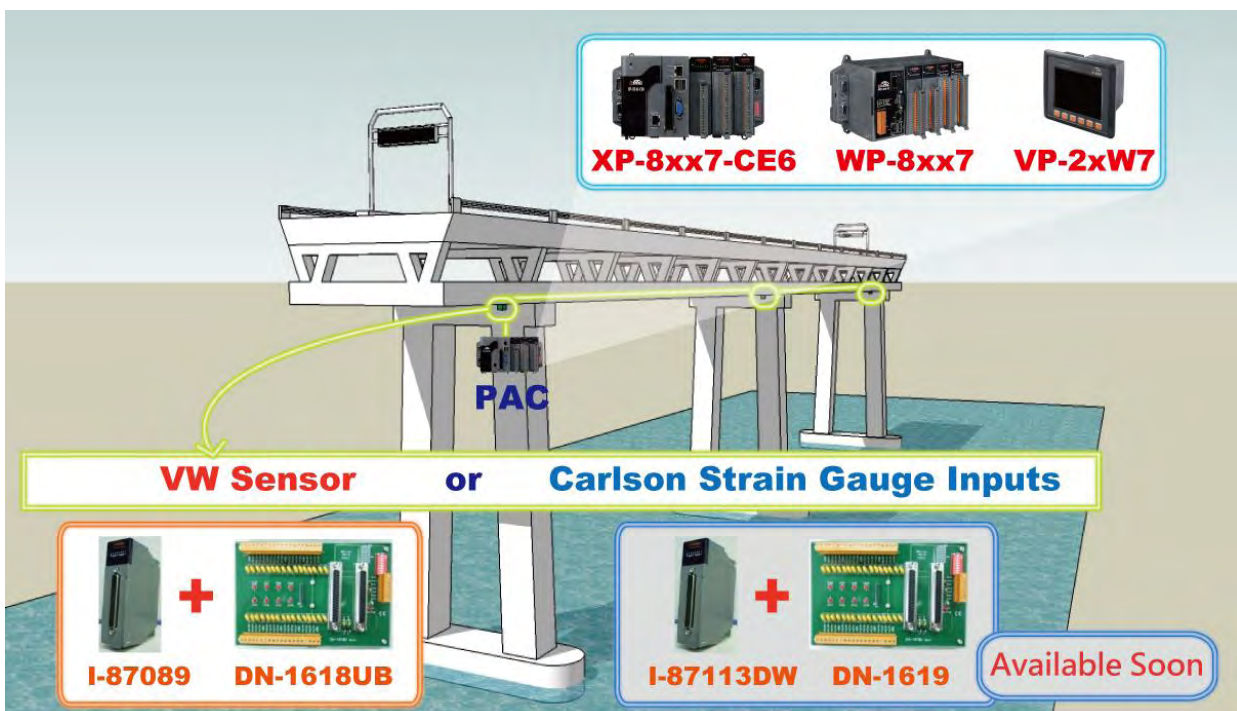

1.20 Fast FRnet Remote I/O

- **Advantage of FRnet I/O:** Fast I/O scan: About 3 ms/scan. (It depends on your program's PLC scan time. Ex: If the ISaGRAF program's PLC scan time is about 9 ms, then the scan time for all will be 9 ms, not 3 ms)
- Note: Doesn't support FRnet AI/AO I/O modules yet.
- www.icpdas.com > FAQ > Software > ISaGRAF Ver.3 (English) - 082

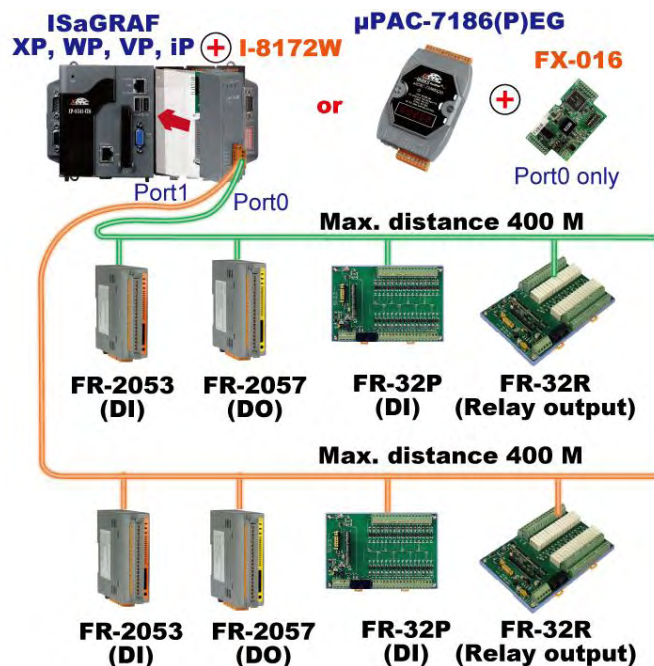

1.21 Integrate with CAN/CANopen Devices & Sensors

- XP-8xx7-CE6 supports max. 32 I-7530 (RS-232 to CAN Converter)
- www.icpdas.com > FAQ > Software > ISaGRAF Ver.3 (English) > 086

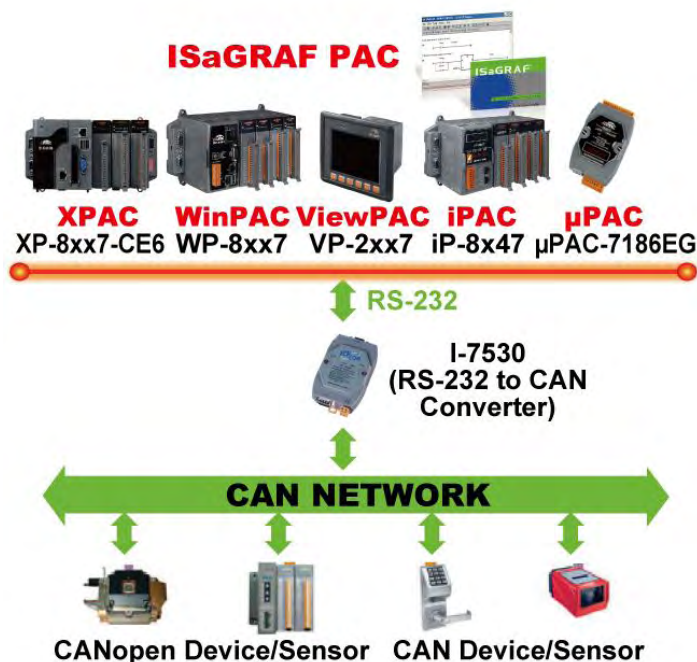

1.22 ZigBee Wireless Solution

The XP-8xx7-CE6 plus ZB-2550P and ZB-2551P RS-232/RS-485 Converters can apply wireless communication, reduce the wiring cost, and achieve the mission of remote I/O control and data acquisition.

Please refer to www.icpdas.com > FAQ > Software > ISaGRAF Ver.3 (English) > 110

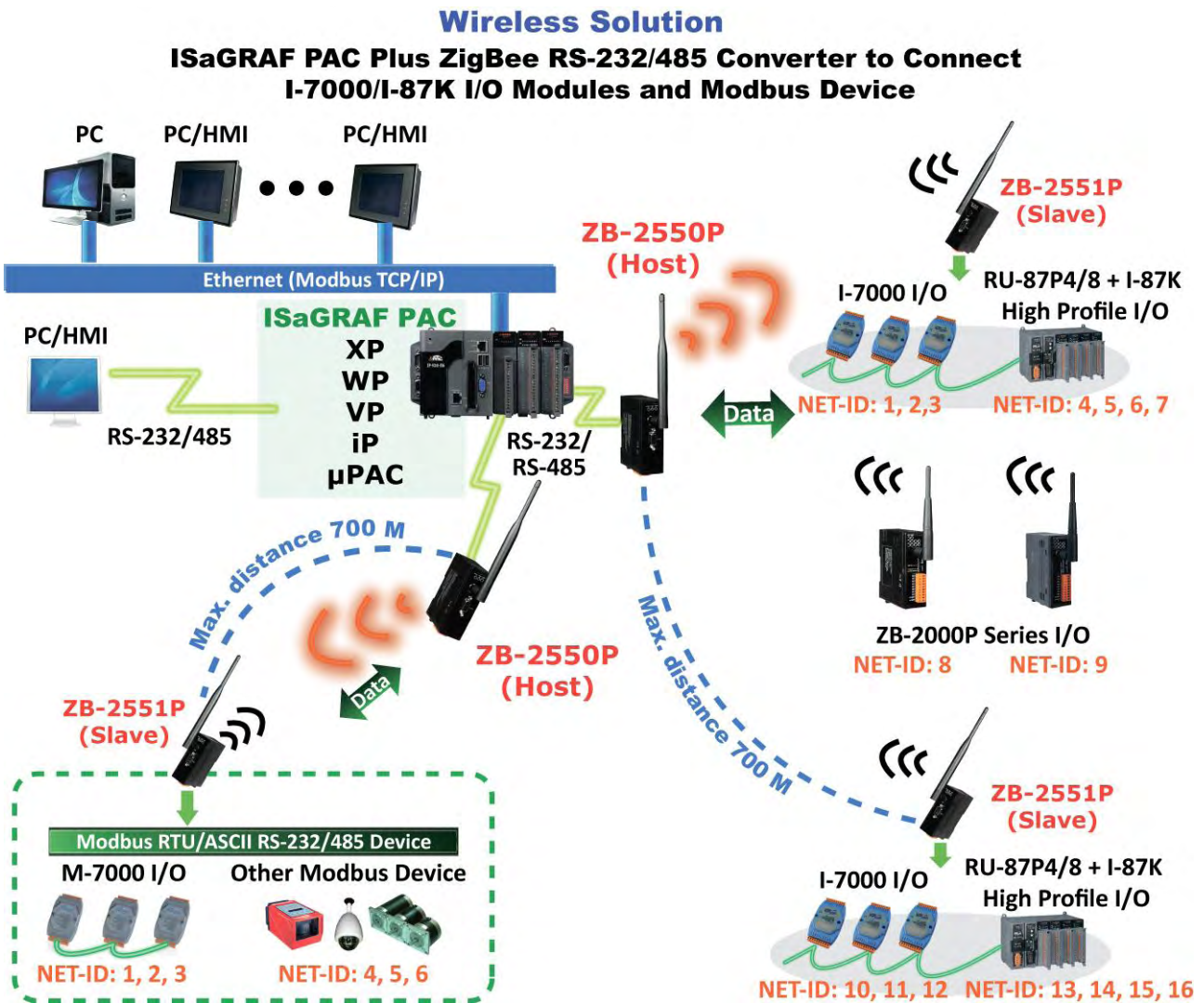

1.23 GPS Application: with I-87211W & GPS-721

- XP-8xx7-CE6, WP-8xx7, VP-2xW7, iP-8xx7, μ PAC-7186(P)EG can support one I-87211W (slot 1~7) or one I-87211W/GPS-721 as RS-485 remote GPS I/O.
- For doing auto-time-synchronization and getting local Longitude and Latitude
- Please refer to www.icpdas.com > FAQ > Software > ISaGRAF Ver.3 (English) > 107
- More GPS receivers at www.icpdas.com > Products > Wireless..... > GPS receiver

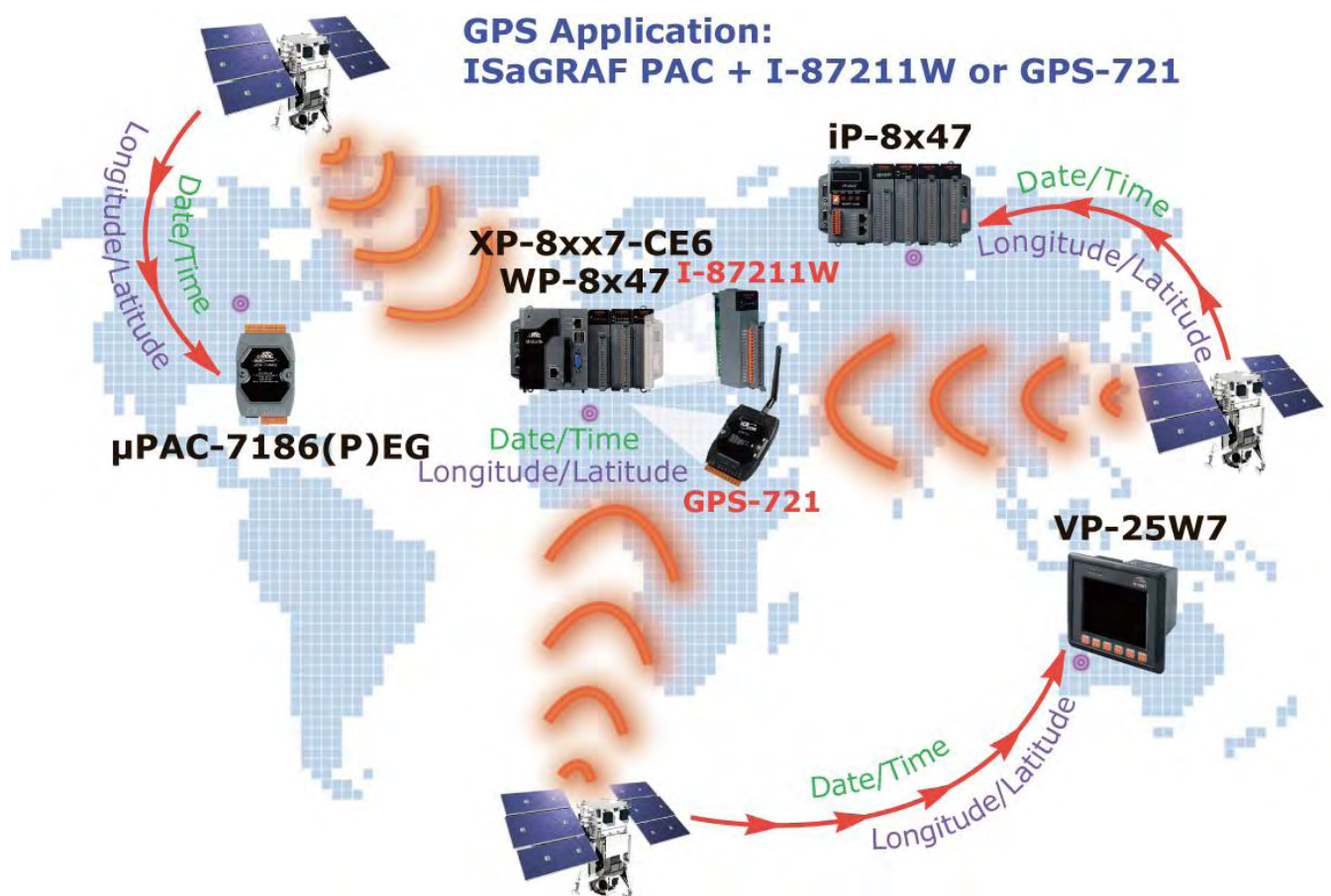

Chapter 2 Software Installation And Working Soft-GRAF HMI with ISaGRAF

Please refer to [Section 2.5](#) for programming the Soft-GRAF HMI applications with ISaGRAF. And refer to [Section 2.4](#) for programming the eLogger HMI application with ISaGRAF.

The XP-8xx7-CE6 is the abbreviation of the XP-8047-CE6/8347-CE6/8747-CE6. The XP-8xx6-CE6 is the abbreviation of the XP-8046-CE6/8346-CE6/8746-CE6.

Important Notice:

1. **XP-8xx7-CE6/8xx6-CE6 supports only the High profile I-8K and I-87K I/O cards in its slot 1 to 7.** Please refer to XP-8xx7-CE6 CD: [\napdos\isagraf\xp-8xx7-ce6\english-manu\](#) for Data sheet.
2. Please always set a **fixed IP** address to the XP-8xx7-CE6. (No DHCP)
Please refer to below location for detailed ISaGRAF English User's Manual.
XP-8xx7-CE6 CD: [\napdos\isagraf\xp-8xx7-ce6\english-manu\](#)
"user_manual_i_8xx7.pdf" & "user_manual_i_8xx7_appendix.pdf"

NOTE:

The XP-8xx7-CE6/8xx6-CE6 supports ISaGRAF programming method & provides Web HMI solution by default.

If user would like to program the XP-8xx7-CE6 by using both ISaGRAF & VS.net 2008, it is also possible. Please refer to [Chapter 6](#) or [Chapter 10](#)

2.1 Step 1 - Installing The ISaGRAF Software

The user has to install two softwares before he can program the XP-8xx7-CE6 controller system. They are

- A. **ISaGRAF Workbench &**
- B. **ICP DAS Utilities For ISaGRAF**

User has to purchase at least one pcs. of ISaGRAF (Ver. 3.4x or Ver. 3.5x ISaGRAF-256-E or ISaGRAF-256-C or ISaGRAF-32-E or ISaGRAF-32-C) to install on his PC to edit, download, monitor & debug the controller system. Item (B) is free and it is burned inside the CD-ROM which is delivered with the XP-8xx7-CE6.

Operating system Requirements:

One of the following computer operating systems must be installed on the target computer system before you can install the ISaGRAF Workbench software program.

- Windows 98, Windows 2000 or Windows XP

- Windows NT Version 3.51 or Windows NT Version 4.0
- Windows Vista (32-bit) or Windows 7 (refer to [FAQ-117](#))

Steps To Installing The ISaGRAF Workbench:

1. Insert the ISaGRAF Workbench CD into your CD-ROM drive.
If your computer does not auto-start the installation, use the Windows Explorer and go to the CD-ROM drive where the Workbench CD is installed.
2. Double-click on the "install.bat" file listed on the ISaGRAF CD.
If the "install.bat" file is not found on your ISaGRAF CD, then double-click on the "ISaGRAF.exe" file to start the installation process.

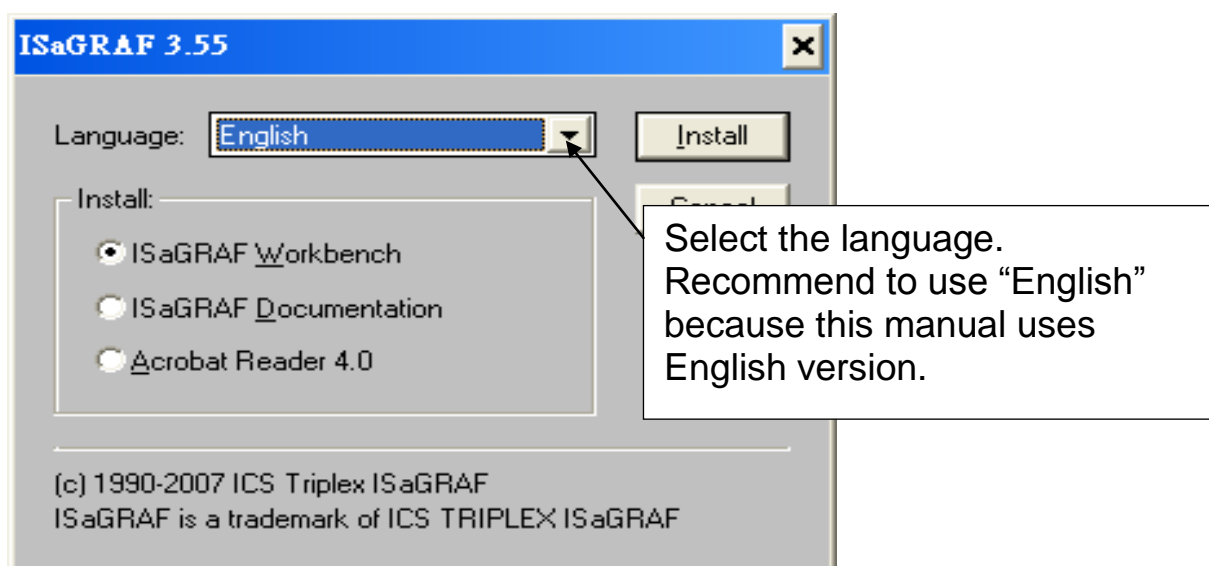

3. To begin the ISaGRAF 3.x software program, click the Windows [Start] button, then click [Programs], and you should see the ISaGRAF program group as illustrated below. Click "Projects" can start ISaGRAF software.

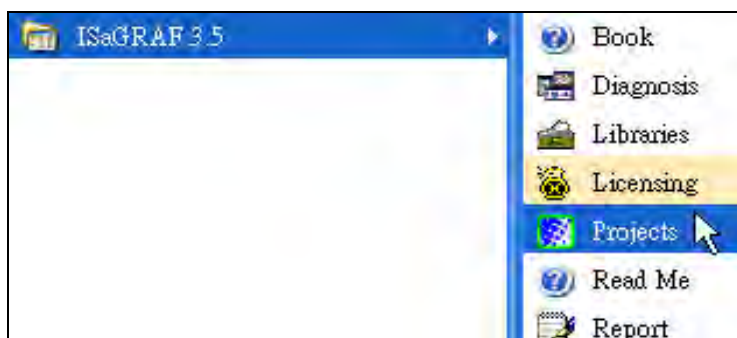

2.1.1 The hardware protection device (dongle & USB Key-Pro)

You must install the hardware protection device (dongle) provided with the ISaGRAF software on your computers parallel port to for the ISaGRAF program to achieve fully authorized functionality. (ISaGRAF-32-E & ISaGRAF-32-C DO NOT need dongle or USB Key-Pro.)

While using ISaGRAF and the dongle is plugged well, if the [Help] > [About] says “Maximum number of IO variables: 32”, it means ISaGRAF workbench cannot find the dongle well. Please reset your PC and then check the [Help] > [About] again.

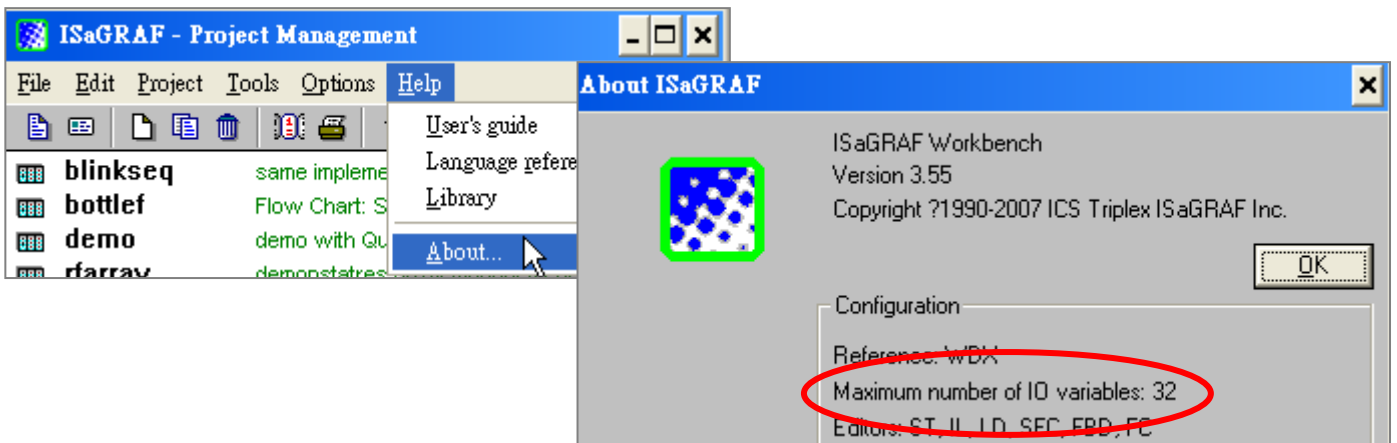

If it still displays “Maximum number of IO variables: 32”, the driver may not be installed well. Please do the following steps.

Dongle Protection:

Please execute the following file (in the ISaGRAF CD_ROM) and then reset the PC again.

- ISaGRAF-80 version : \Sentinel5382\setup.exe
- Other ISaGRAF version : \Sentinel\setup.exe

USB Key-Pro Protection:

1. To make your PC recognize the ISaGRAF USB protection-key, please **un-plug** the USB protection-key from your USB port first, then run “\Sentinel\SSD5411-32bit.exe” in the ISaGRAF 3.51~3.55 CD-ROM (or later version) after you have installed the ISaGRAF. Then reset your PC.
2. To run ISaGRAF Ver. 3.5x, please always plug the USB protection-key in the PC’s USB port.

2.1.2 Important Notice For Window NT Users

If your computer is using the Windows NT operating system, you will need to add one line to the "isa.ini" file in the ISaGRAF Workbench "EXE" subdirectory. C:\isawin\exe\isa.ini

You can use any ASCII based text editor (such as Notepad or UltraEdit32) to open the "isa.ini" file. Locate the [WS001] header in the "isa.ini" initialization file (it should be at the top of the file). Anywhere within the [WS001] header portion of the "isa.ini" initialization file, add the entry shown below within the [WS001] header:

```
[WS001]
NT=1
Isa=C:\ISAWIN
IsaExe=C:\ISAWIN\EXE
Group=Samples
IsaApl=c:\isawin\smp
IsaTmp=C:\ISAWIN\TMP
```

2.1.3 Important Notice For Windows 2000 users

When closing my ISaGRAF window on windows 2000, it holds. Why ? This problem usually happens on the windows 2000. When you close some ISaGRAF windows by clicking on the "X" , it holds about 20 to 40 seconds (No response). This "hold" behavior may be caused by the "CTFMON.EXE" process of Windows 2000.

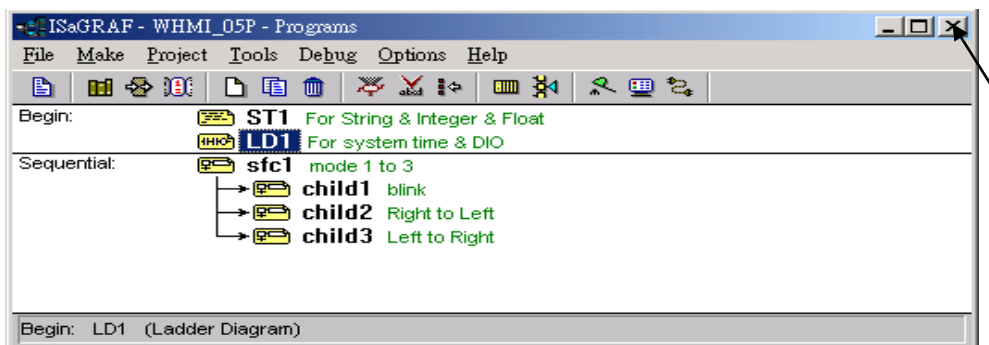

The problem shooting

You may stop this process by click on the “Ctrl” & “Alt” & “Del” at the same time to open the window Task Manager, and then stop it as next page.

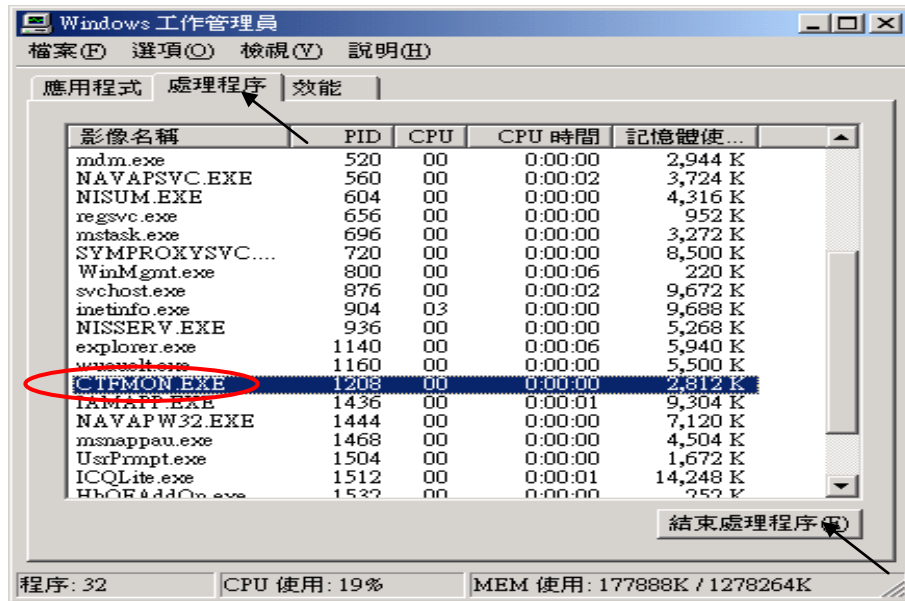

However you will find the “CTFMON.EXE” still load to run when you reboot your PC or run Microsoft Office. So you need to stop it every time when your windows 2000 is rebooted. If you want to know more about the “CTFMON.EXE”, please visit www.microsoft.com & search “CTFMON.EXE”.

One Quick way to avoid the “hold” problem on windows 2000:

You may create a short cut for the “ISaGRAF project manager. And then check on "run in separate memory space" option in the shortcut property.

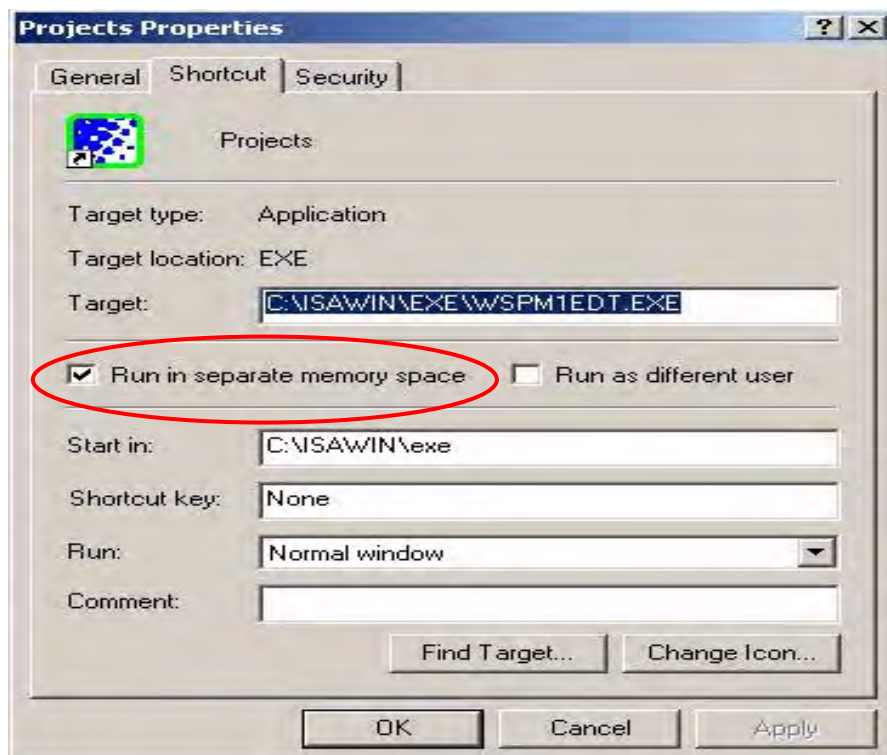

2.2 Step 2 - Installing The ICP DAS Utilities For ISaGRAF

The “ICP DAS Utilities For ISaGRAF” consists of 3 major items.

- I/O libraries (for all ICP DAS ISaGRAF controllers)
- Modem_Link utility
- Auto-scan I/O utility

Note:

The ISaGRAF Workbench software program must be installed before attempting to install the “ICP DAS Utilities for ISaGRAF”. If you have not installed the ISaGRAF Workbench program, please refer to [step 1](#) before continuing.

There is a CD-ROM supplied with each of the XP-8xx7-CE6 PAC with the “ICP DAS Utilities for ISaGRAF”. Please insert the CD-ROM into your CD-ROM drive. Then run **CD-ROM: \napdos\isagrafsetup.exe** . Follow the steps to install it.

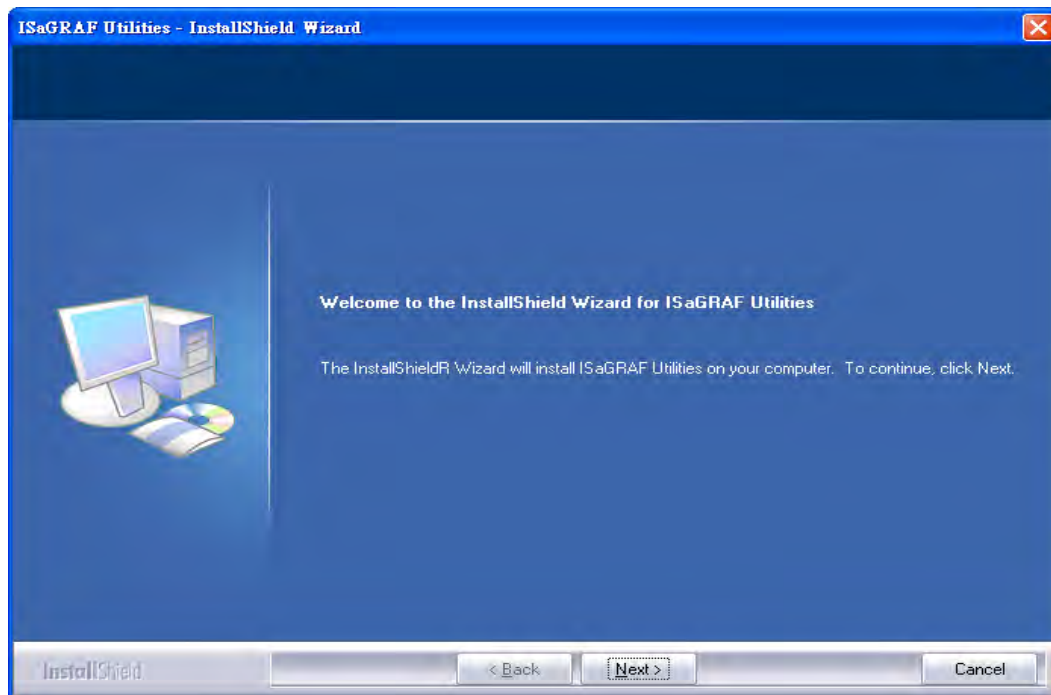

Note:

If “ICP DAS Utilities for ISaGRAF” is not in your CD-ROM, please download “**ICP DAS Utilities For ISaGRAF.zip**” from <http://www.icpdas.com/products/PAC/i-8000/isagraf.htm> > Driver.

2.3 Step 3 - Installing The Web Page Editor

This is an option. You may not need it if you are very familiar with the HTML design. It is also possible to use any text editor to build web pages, for example, "Notepad" on the windows 2000 or XP.

We will use "Microsoft Office FrontPage 2003" (or later compatible version) to build web pages in this manual.

User may choose your prefer web page editor to do the same thing.

2.4 Working eLogger HMI with ISaGRAF SoftLogic

ICP DAS eLogger is an easy and useful HMI development tool which helps user to create user-friendly pictures and control items.

eLogger HMI application can work with ISaGRAF Softlogic application in the following PACs:

- WP-8147 / 8447 / 8847
- WP-8137 / 8437 / 8837
- VP-25W7 / 23W7
- XP-8047-CE6 / 8347-CE6 / 8747-CE6

Please refer to www.icpdas.com > FAQ > Software > ISaGRAF > FAQ-115 for more information about programming an eLogger application.



2.5 Working Soft-GRAF HMI with ISaGRAF SoftLogic

Based on the popular ISaGRAF software, Soft-GRAF is an add-on HMI designer developed by ICP DAS. This evolutionary Soft-GRAF provides abundant HMI graphic objects, just a few simple parameters setting to realize the flexible and colorful HMI. Moreover, you can also add the new HMI graphic objects to any existed projects through the function menu of ISaGRAF software. Now, you just need only one ISaGRAF software to achieve both HMI and control logic design.



Feature:

- All-in-one Design:
Design the control logic and HMI by single ISaGRAF software.
- Support various and colorful HMI objects:
 - Page (Max. 200, support password security)
 - Numeric (Input, input security, display)
 - Text (Dynamic/static text display)
 - Picture (Animated/static picture display)
 - Moving Trace (1-axis or 2-axis)
 - Built-in various objects (Will be more)



- Multi-language:
English, Traditional Chinese, Simplify Chinese, etc.
- HMI behave smoothly

Information and links:

- For more information, refer to FAQ 131:
[www.icpdas.com > FAQ > Software > ISaGRAF Ver.3 \(English\) - 131](http://www.icpdas.com > FAQ > Software > ISaGRAF Ver.3 (English) - 131)
Soft-GRAF : Create A Colorful HMI in The XP-8xx7-CE6 and WP-8xx7 and VP-2xW7 PAC
- The following ISaGRAF drivers support the Soft-GRAF:
XP-8xx7-CE6 : Ver. 1.07 or later
WP-8x37/8x47 : Ver. 1.28 or later
VP-25W7/23W7 : Ver. 1.19 or later

The latest version of ISaGRAF driver:

<http://www.icpdas.com/products/PAC/i-8000/isagraf-link.htm> .

Chapter 3 Setting Up A Web HMI Demo

The XP-8xx7-CE6 is the abbreviation of the XP-8047-CE6/8347-CE6/8747-CE6.
The XP-8xx6-CE6 is the abbreviation of the XP-8046-CE6/8346-CE6/8746-CE6.

Important Notice:

1. The XP-8xx7-CE6 / XP-8xx6-CE6 supports only High profile I-8K and I-87K I/O cards in its slot 1 to 7 (The leftmost I/O slot number is 1).

Refer to the XP-8xx7-CE6 CD:

[\napdos\isagraf\xp-8xx7-ce6\english-manu\](#) for datasheet

2. Please always set a **fixed IP** address to the XP-8xx7. (No DHCP)
Recommend to use the NS-205 / NS-208 Industrial Switch for XP-8xx7-CE / XP-8xx6-CE6.

3.1 Web Demo List

The Web page location:

XP-8xx7-CE6 CD-ROM: [\napdos\isagraf\xp-8xx7-ce6\xpce6-webhmi-demo\](#)

The respective ISaGRAF project location:

XP-8xx7-CE6 CD-ROM: [\napdos\isagraf\xp-8xx7-ce6\demo\](#)

Demo list:

Name	Description	I/O board
sample	A Web HMI sample	No I/O board
example1	A simple example listed in Chapter 4	slot 1: I-87055W
xphmi_01	Display controller's date & time	No I/O board
xphmi_02	DI & DO demo	slot 1: I-87055W
xphmi_03	Read / Write Long, float & Timer value	No I/O board
xphmi_04	Read / Write controller's String	No I/O board
xphmi_05	Multi-Pages demo Page menu is on the Left	slot 1: I-87055W
xphmi_05a	Multi-Pages demo Page menu is on the Top	slot 1: I-87055W
xphmi_06	AIO demo, scaling is in ISaGRAF	slot 2: I-87024W slot 3: I-8017HW
xphmi_07	AIO demo, scaling is in PC	slot 2: I-87024W slot 3: I-8017HW
xphmi_08	download controller's file to PC	slot 1: I-87055W
xphmi_09	pop up an alarm window on PC	slot 1: I-87055W
xphmi_11	Trend curve.	slot 2: I-87024W slot 3: I-8017hW
xphmi_12	Record 1 to 8 Ch. i8017HW 's volt every 50ms and draw trend curve by M.S.Excel	slot 3: I-8017hW slot 2: I-8024W
xphmi_13	Record 1 to 4-Ch. i8017HW's voltage every 10ms and draw trend curve by M.S.Excel	slot 3: I-8017hW slot 2: I-8024W

3.2 Steps To Set Up A Web HMI Demo

3.2.1 Step 1 - Setup The Hardware

A. Please have one XP-8347-CE6 or XP-8747-CE6 and plug one I-87055W in its slot 1.

If you don't have the I-87055W (8 IN & 8 OUT board), please follow the same steps as below however your Web HMI demo may be replaced to "xphmi_01" not "xphmi_05"

B. Prepare one VGA monitor, one USB mouse and one ethernet cable and then connect them to the XP-8xx7-CE6. (Keyboard is using the software keyboard on the bottom-right of the VGA screen)

C. Power the XP-8xx7-CE6 up.

3.2.2 Step 2 - Setting The Web Options

A. Please refer to the Appendix A.3 of the XP-8xx7-CE6 getting started manual to set a **fixed IP** address to the XP-8xx7-CE6. (No DHCP)

B. Check on "Enable Web HMI" and then click on "Setting", Please check the "Enable Account Security" and then click on "Edit" to set (username , password). **Then remember to click on "OK"**

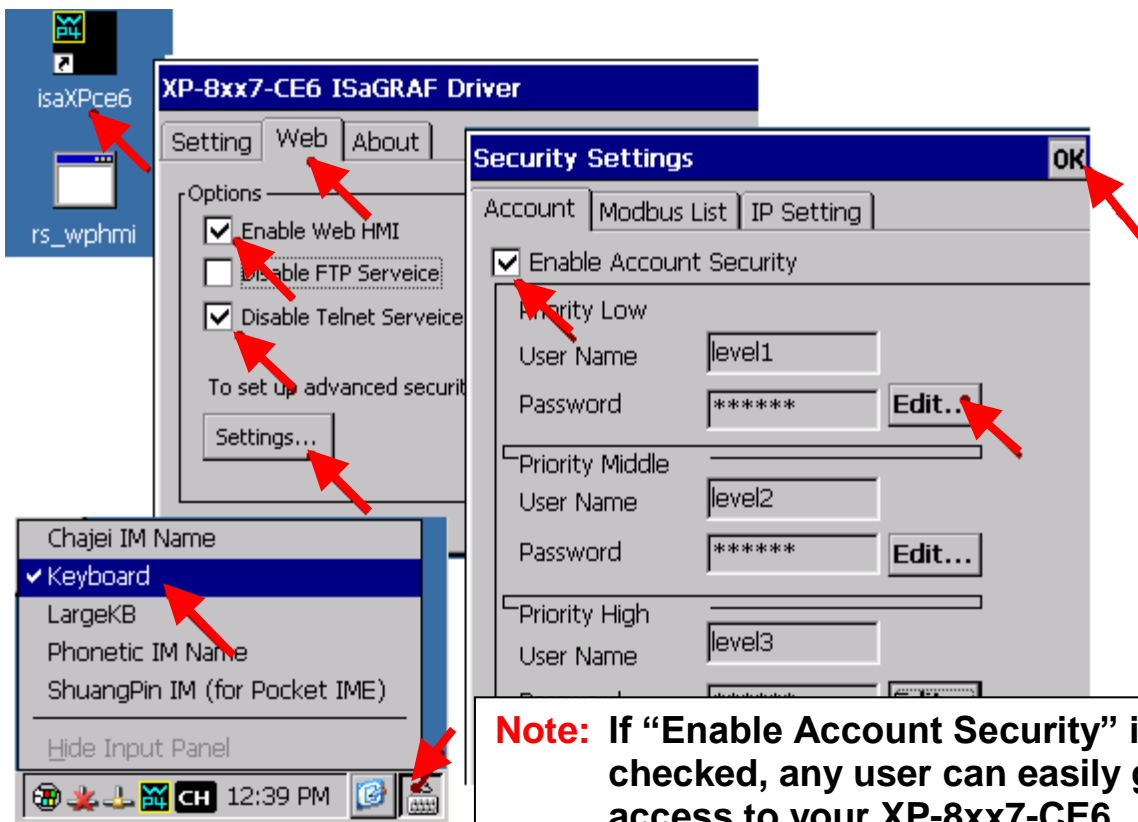

3.2.3 Step 3 - Download ISaGRAF Project

Please download ISaGRAF project “**xphmi_05**” to the XP-8XX7-CE6. It is in the XP-8xx7-CE6 CD: \napdos\isagraf\xp-8xx7-ce6\demo\ “**xphmi_05.pia**”

xphmi_05 demo need one I-87055W. If you don't the I-87055W (8-IN/8-OUT card), download “**xphmi_01**” (CD:\napdos\isagraf\xp-8xx7-ce6\demo\)

If you know how to restore “xphmi_05.pia” to your ISaGRAF Workbench and download it to the controller, please go ahead to the [section 3.2.4](#).

However if you don't know it, please refer to the below steps. Please make sure the ISaGRAF Workbench is already installed to your PC. (refer to the [section 2.1 & 2.2](#))

Steps To Backing Up & Restoring An ISaGRAF Project:

For archiving purposes you can "Back Up" and "Restore" an ISaGRAF project. For example, you may want someone to test your program or email to service@icpdas.com for ICP DAS's ISaGRAF technical service.

Backing Up the ISaGRAF Project

In the "ISaGRAF Project Management" window:

1. Click [Tools] > [Archive] > [Projects] to open the [Archive] window.
2. Click "Browse" can change the directory of file (ex: C:\Demo)
3. Select the projects want to backup from "Workbench"
4. Click "Backup" to backup to the selected folder (ex: \Demo\example1.pia)

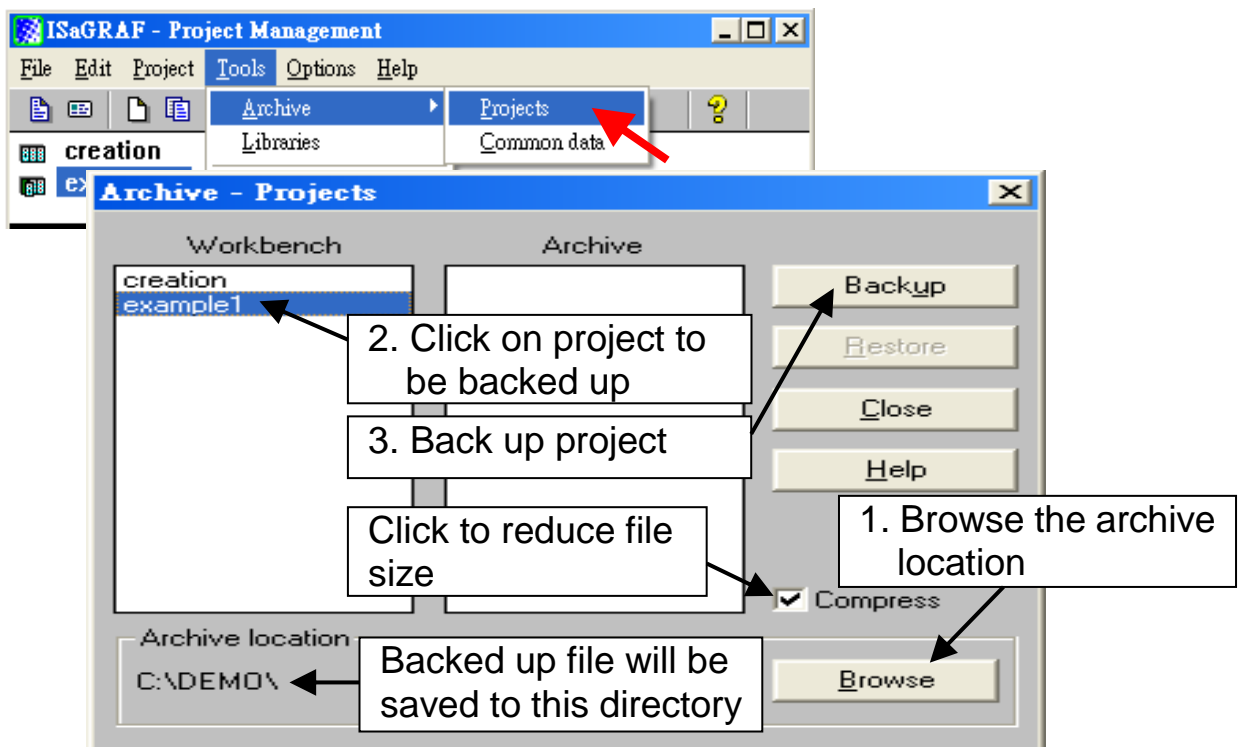

Restoring An ISaGRAF Project

To restore an ISaGRAF project from a backed up file(*.pia), use the 1 & 2 steps of above backup file steps, then:

1. Click on the file name want to restroe from the "Archive" window
2. Click on the "Restore" button to restore the ISaGRAF project.

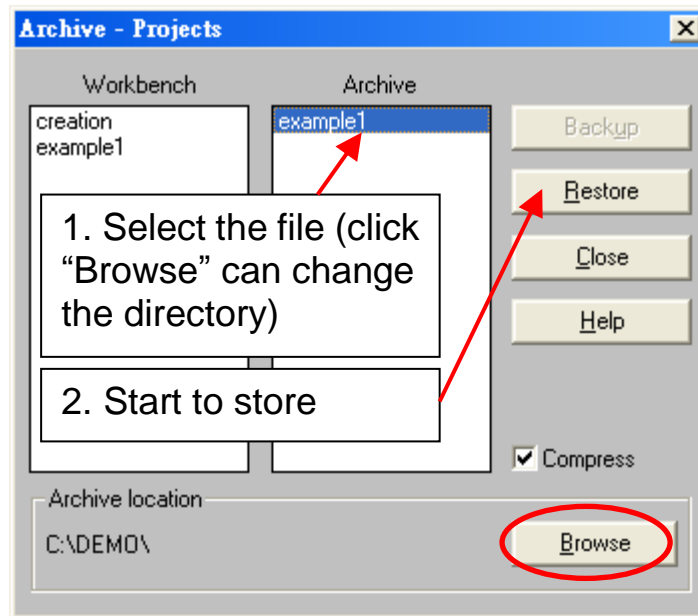

3.2.3.1 Steps To Download an ISaGRAF Project To The Controller:

Double click on the "xphmi_05" to get into the project. Then click on "Link setup".

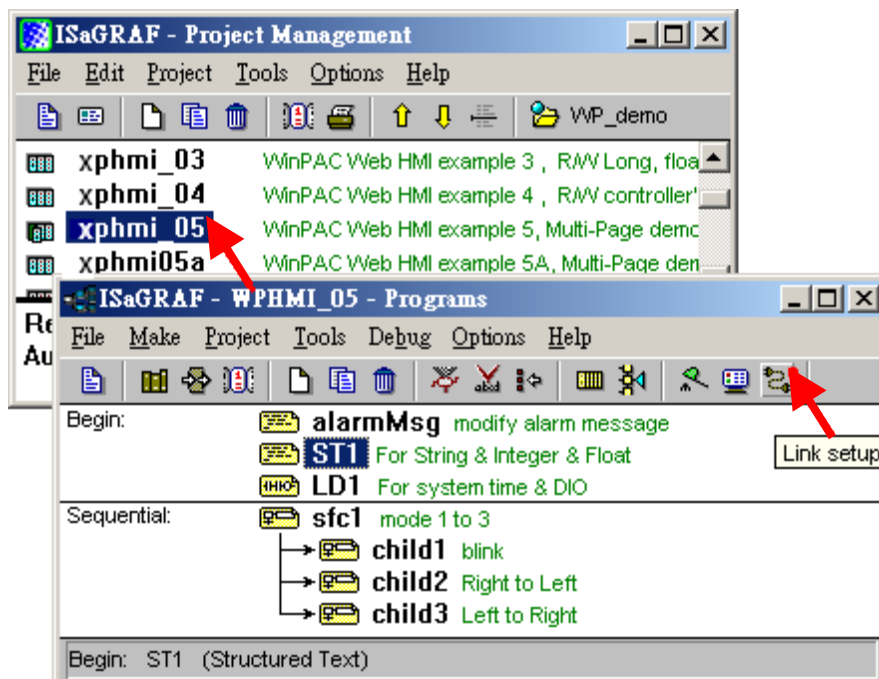

Click on “Setup” first and then entering the IP address of your controller. The port number should be 502.

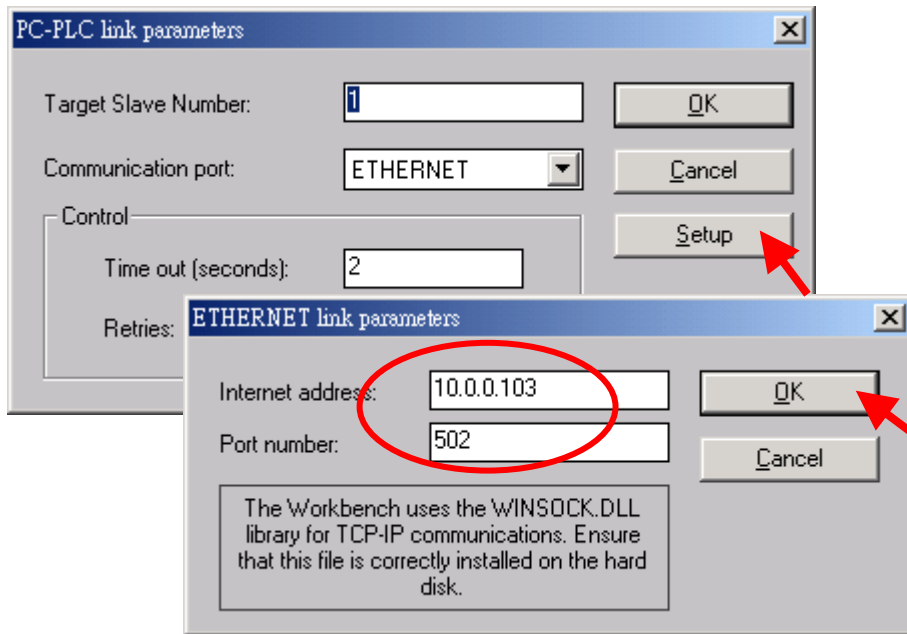

To download “xphmi_05” project to the XP-8xx7-CE6, Click on “Debug” . If communication is established, click on “stop” first to stop the old project running in the XP-8xx7-CE6.

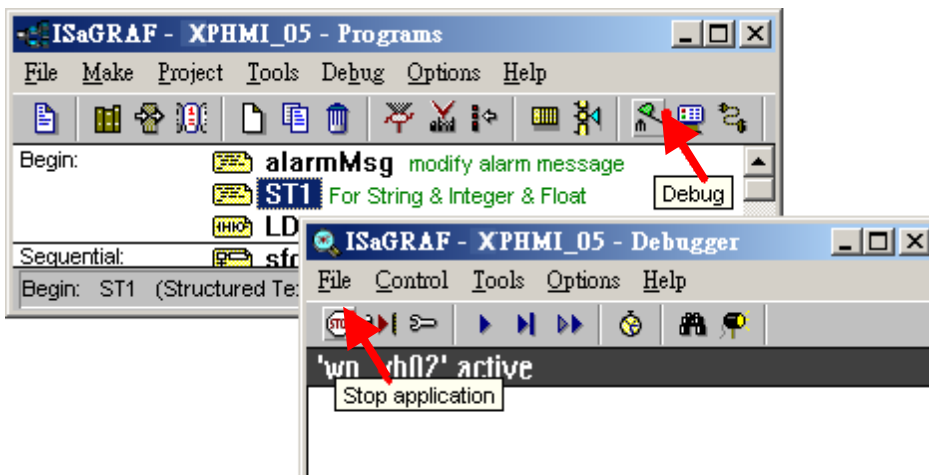

Then click on “Download” to download it to the controller.

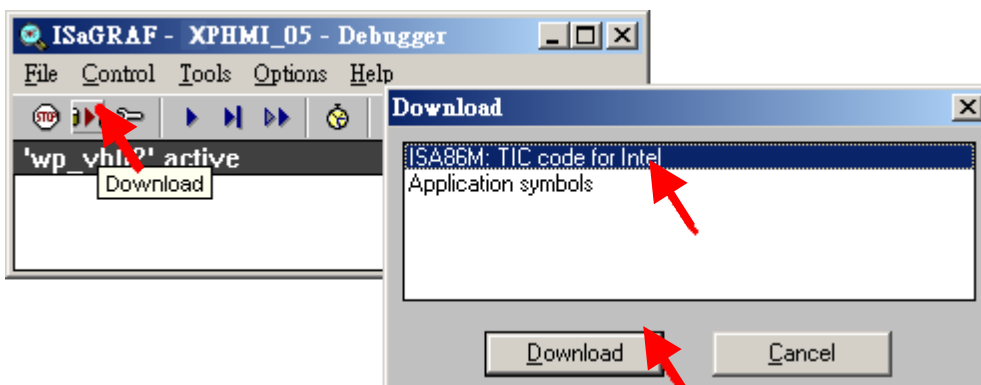

3.2.4 Step 4 - Download Web Pages To The XPAC

A. Please copy all files in the XP-8xx7-CE6 CD-ROM:

CD: \napdos\isagraf\xp-8xx7-CE6\xpce6-webhmi-demo\xphmi_05\ *.*
to the XP-8Xx7-CE6 's \System_Disk\Temp\HTTP\WebHMI\

xphmi_05 demo need one I-87055W in its slot 1. If you don't have the I-87055W (8 IN & 8 OUT board), you may download "xphmi_01"

B. Since the Web Pages are modified or new copied, please run "rs_wphmi.exe" to reset the Web server.

The "rs_wphmi.exe" must be run every time when user has modified any file in the XP-8xx7-CE6 's \System_Disk\Temp\HTTP\WebHMI



3.2.5 Step 5 - Show Time

Please run Internet Explorer (Rev. 6.0 or higher) on PC, key in the IP address of your XP-8xx7-CE6. For example: 61.218.42.10 or <http://61.218.42.10>



Chapter 4 Programming A Web HMI Example

This chapter shows you how to build a simple ISaGRAF project and Web HMI. The XP-8xx7-CE6 is the abbreviation of the XP-8047-CE6/8347-CE6/8747-CE6. The XP-8xx6-CE6 is the abbreviation of the XP-8046-CE6/8346-CE6/8746-CE6.

Important Notice:

1. **XP-8xx7-CE6/8xx6-CE6 supports only the High profile I-8K and I-87K I/O cards in its slot 1 to 7.** Please refer to XP-8xx7-CE6 CD: [\napdos\isagraf\xp-8xx7-ce6\english-manu\](#) for Data sheet.
2. Please always set a **fixed IP** address to the XP-8xx7-CE6. (No DHCP)
3. Recommend to use NS-205 or NS-208 Industrial Ethernet Switch for XPAC.

Please refer to below location for detailed ISaGRAF English User's Manual. XP-8xx7-CE6 CD: [\napdos\isagraf\xp-8xx7-ce6\english-manu\](#) "user_manual_i_8xx7.pdf" - Section 2.1 for detailed ISaGRAF programming basics.

If user would like to program XP-8xx7-CE6 by using both ISaGRAF and VS.net 2008, it is also possible. Please refer to [Chapter 6](#) or [Chapter 10](#).

4.1 Writing A Simple ISaGRAF Program

We are going to use ISaGRAF Workbench to write a simple ISaGRAF example program, then download it to the XP-8xx7-CE6 controller (with one **I-87055W** I/O board in its slot 1) to make it work. If you haven't installed "ISaGRAF" & "ICP DAS Utilities for ISaGRAF", please go back to read chapter 2.

This example contains one Ladder program. (This demo program resides at the XP-8xx7-CE6 CD-ROM: [\napdos\isagraf\xp-8xx7-ce6\demo\](#) "example1.pia")

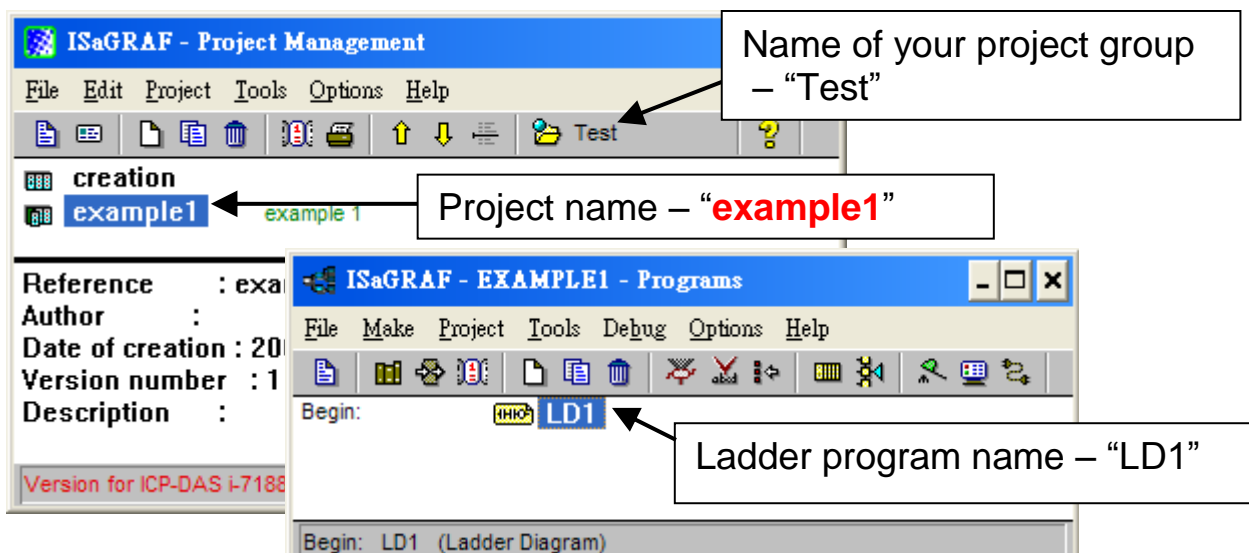

Variables declaration:

Name	Type	Attribute	Description
OUT01	Boolean	Output	Output 1 in the I-87055W, Modbus network addr = 1
OUT02	Boolean	Output	Output 2 in the I-87055W, Modbus network addr = 2
K1	Boolean	Input	Input 1 in the I-87055W, Modbus network addr = 11
K2	Boolean	Input	Input 2 in the I-87055W, Modbus network addr = 12
T1	Timer	Internal	Time Period of blinking, initial value set as T#8s Modbus network addr = 21

Ladder Logic Program Outline:

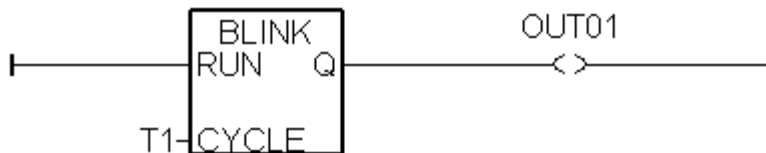

4.1.1 Open ISaGRAF-Project Management

Click on the Windows [Start] > [Programs] > [ISaGRAF 3.4] (or ISaGRAF 3.5) > [Projects] to run the ISaGRAF Workbench.

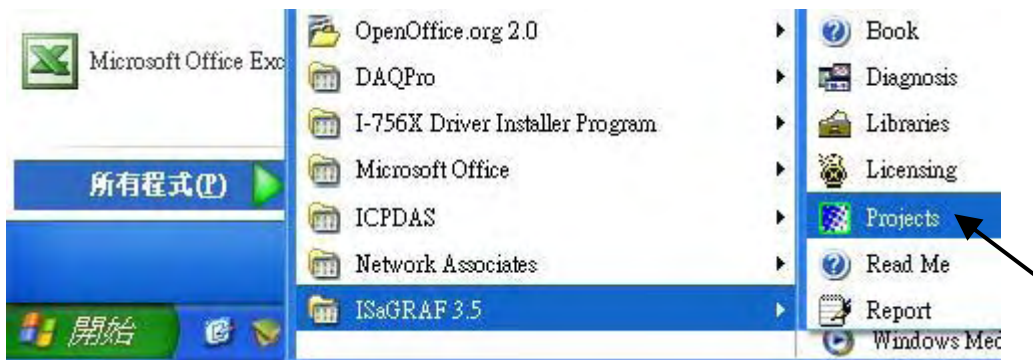

4.1.2 Creating An ISaGRAF User's Group

Click on the "Select Project Group", and then click on "New Group", then type in the name for the new user's group you wish to create, and last click on "OK".

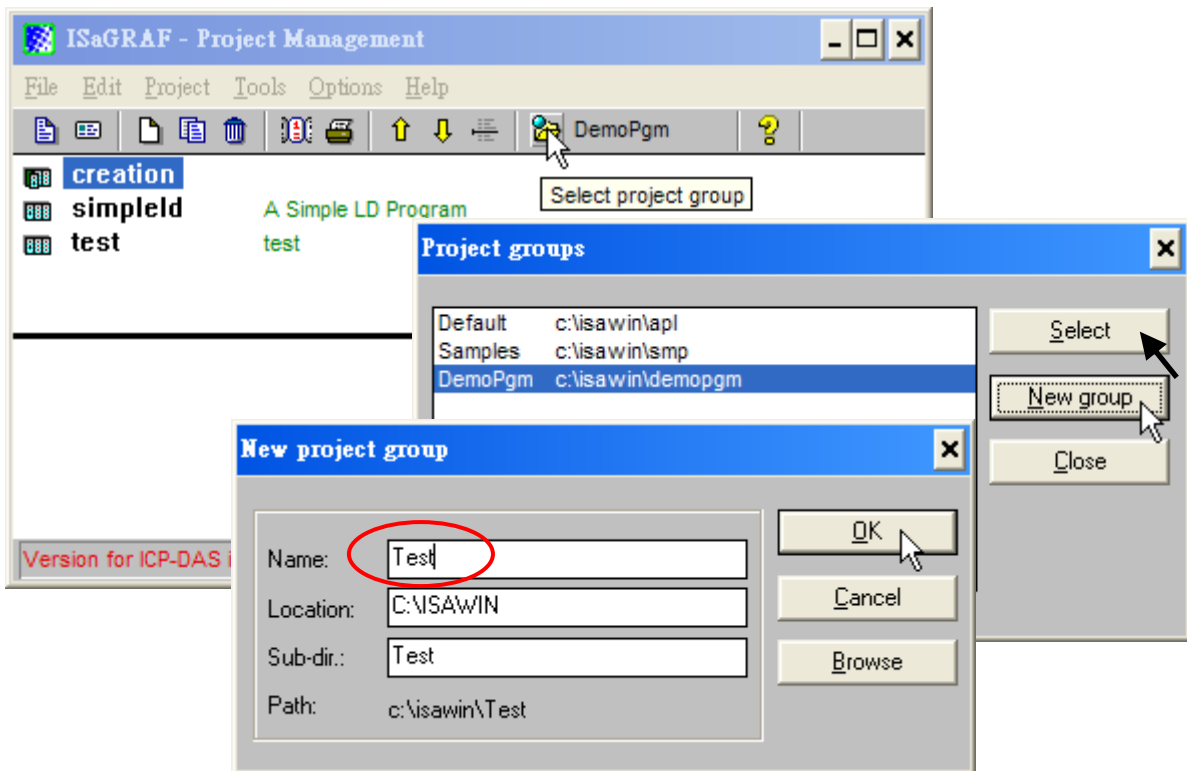

4.1.3 Creating A New ISaGRAF Project

To start a new ISaGRAF project, click on the "Create New Project" icon and enter in the name for the new project.

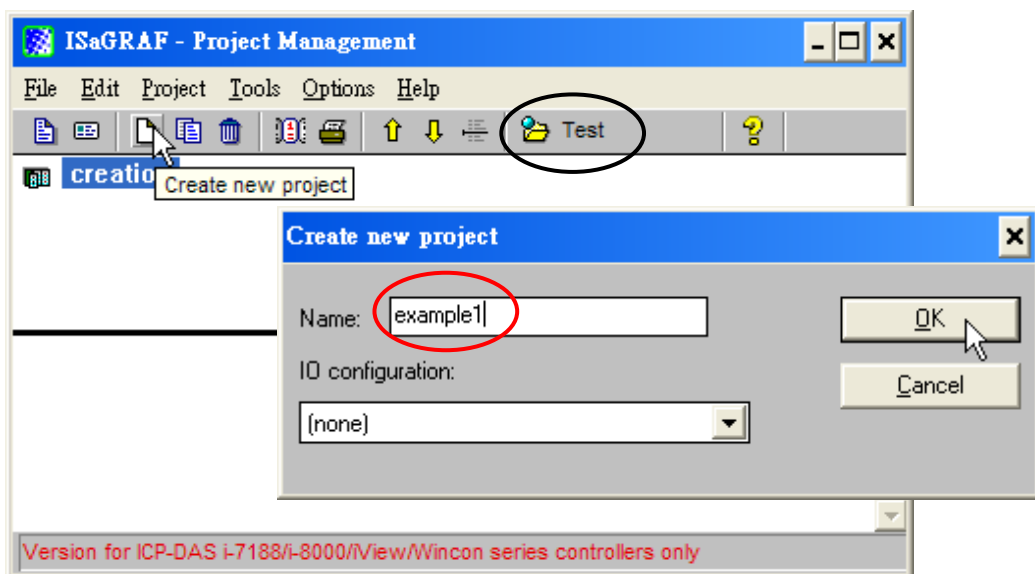

You can then enter additional information for your project by clicking on the "Edit" and then "Set Comment Text" menu as illustrated below.

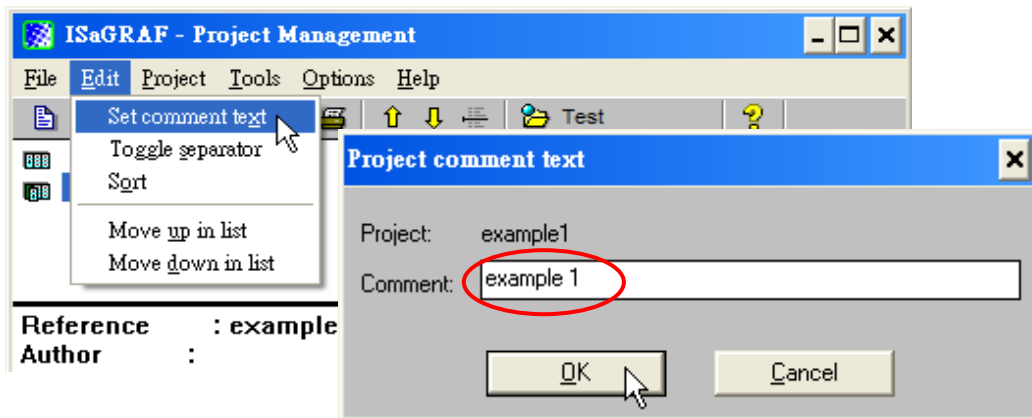

You will now see the name of the new project in the "Project Management" window. Double click on the name of the new project to open the new project.

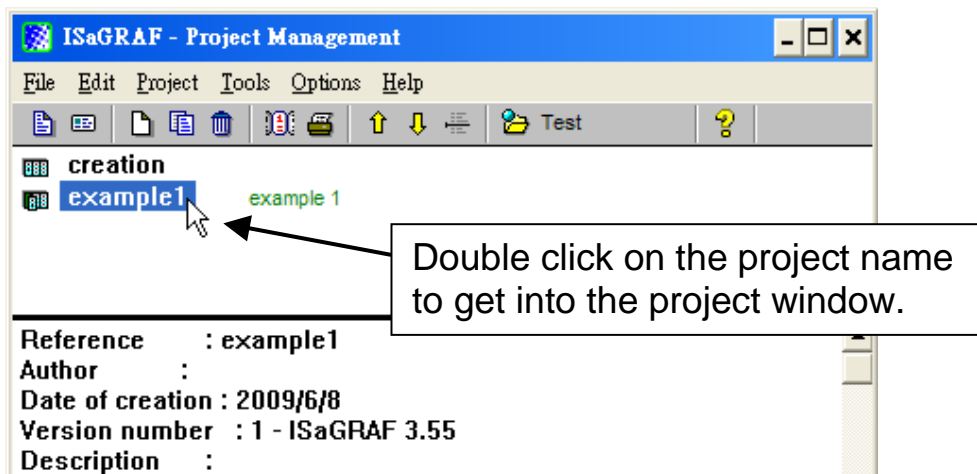

4.1.4 Declaring The ISaGRAF Project Variables

Before you can start creating an ISaGRAF program, you must first declare the variables that will be used in the ISaGRAF program.

Declare the Boolean Variables

1. Click on the "Dictionary" icon

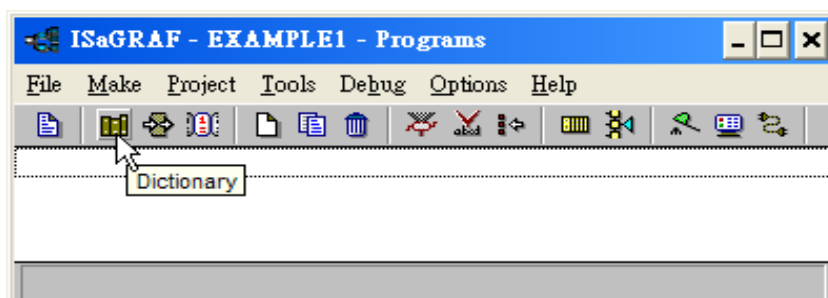

2. Click on the "Boolean" tab to declare the **Boolean variables** that will be used in our example program.

- Double click on the colored area below the "Boolean" tab, and a "Boolean Variable" window will open.

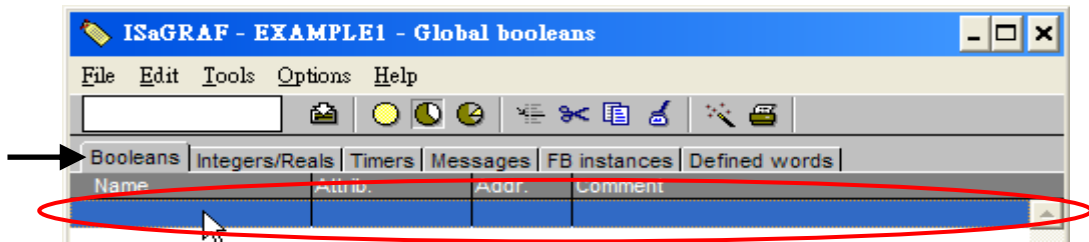

- Enter in the name of the variable to be used in the project. For the purpose of this example program the variable "Boolean Variable Name" is "K1".
- Add "Input 1 in the I-87055W board" to the "Comment Section".
- Then declare the type of "Attribute". In this example program, K1's attribute will be an "Input".
- Then press the "Store" button to save it.

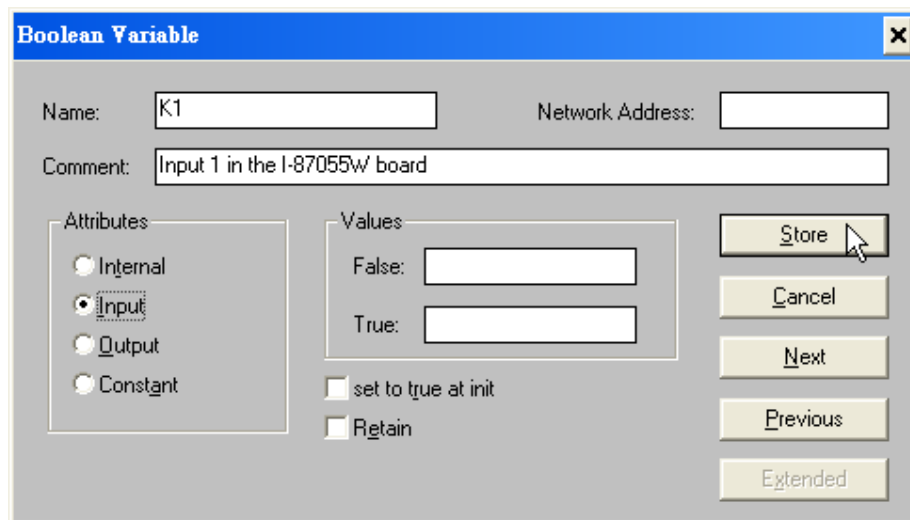

NOTE:

You **MUST** make sure that the variable you have declared has the desired **Attribute** assigned. If you decide that you want to change a project variable's attribute, just double click on the variable name and you can reassign the attribute for the variable.

Please follow the above same step to declare one another Boolean variable – "K2". Then you will have as below.

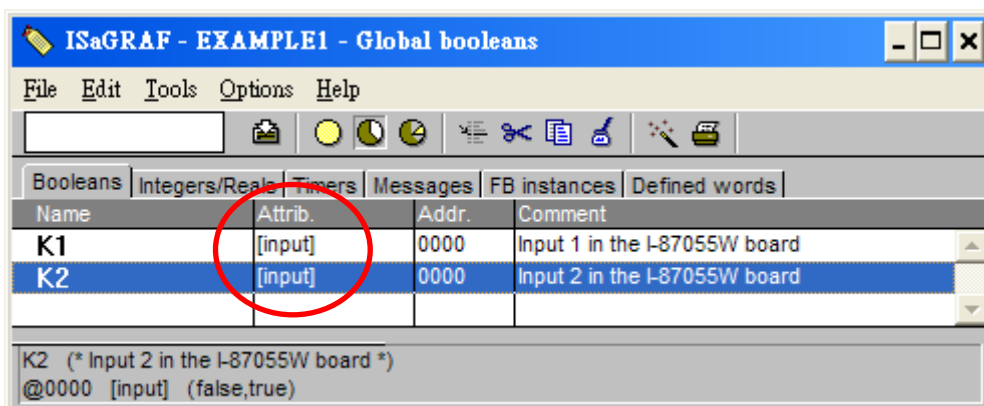

Quick way to declare

There are two outputs used in this example program named "OUT01 and OUT02". ISaGRAF provides a **quick and easy way to declare** like variables that are sequentially ordered.

1. Click on the "Quick Declaration" icon.
2. Enter the output number that you will start with the "Numbering" in "from" and "To" fields (this example uses from 1 to 2).
3. Enter the "Symbol" name for the output variables being declared.
4. Set the attribute to "Output". Click on the "OK" button.
5. When you click on the "OK" button, all two outputs will be immediately added to the "Global Boolean" window. Click on "Save" to store them.

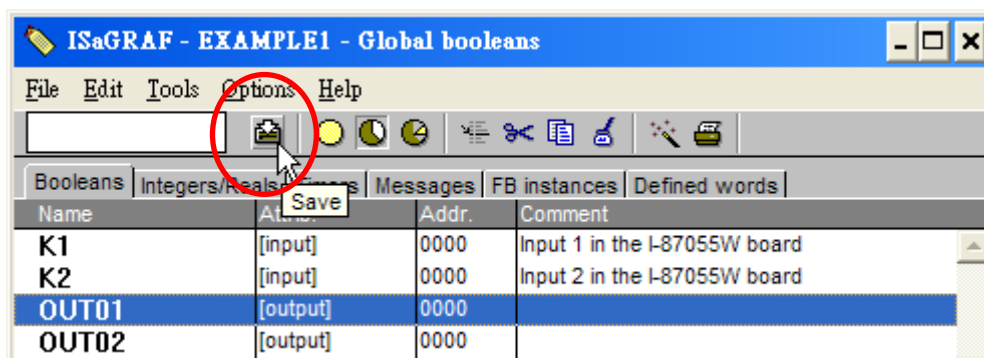
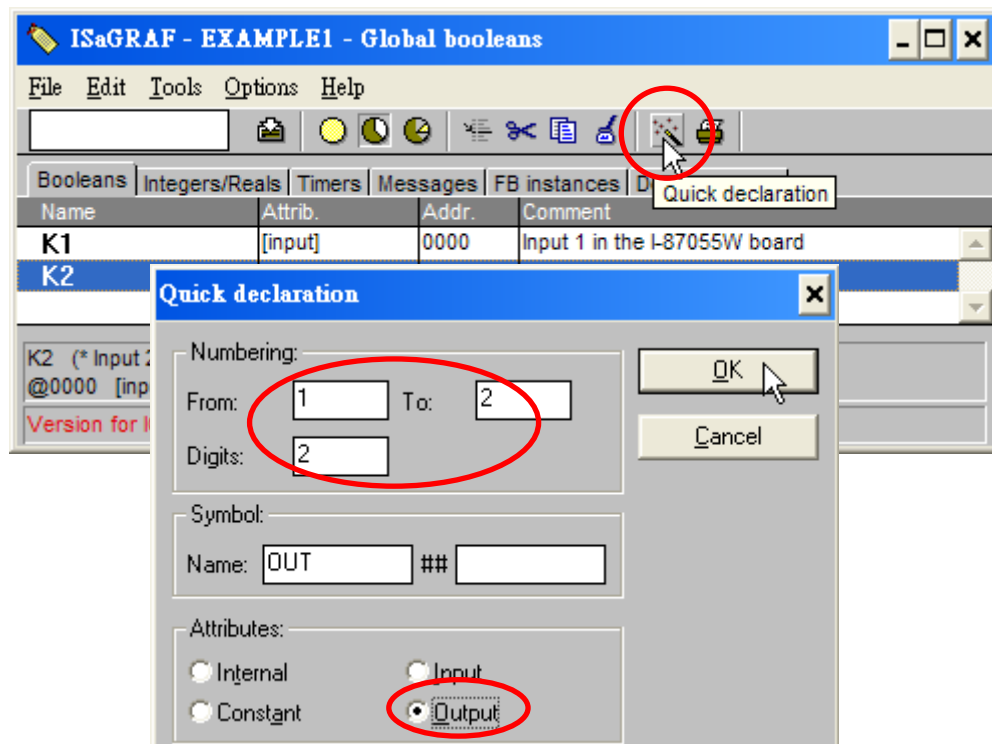

Declare the Timer Variables

To declare the timer (T1) variable used in this example program, click on the "Timers" tab in the setup screen.

1. Double click on the colored area and enter the Name as "T1".
2. Set the "Attributes" to "Internal".
3. Set the "Initial Value" to "T#8s".
4. Click on the "Store" button.
5. Click on "X" to close the "dictionary" window.

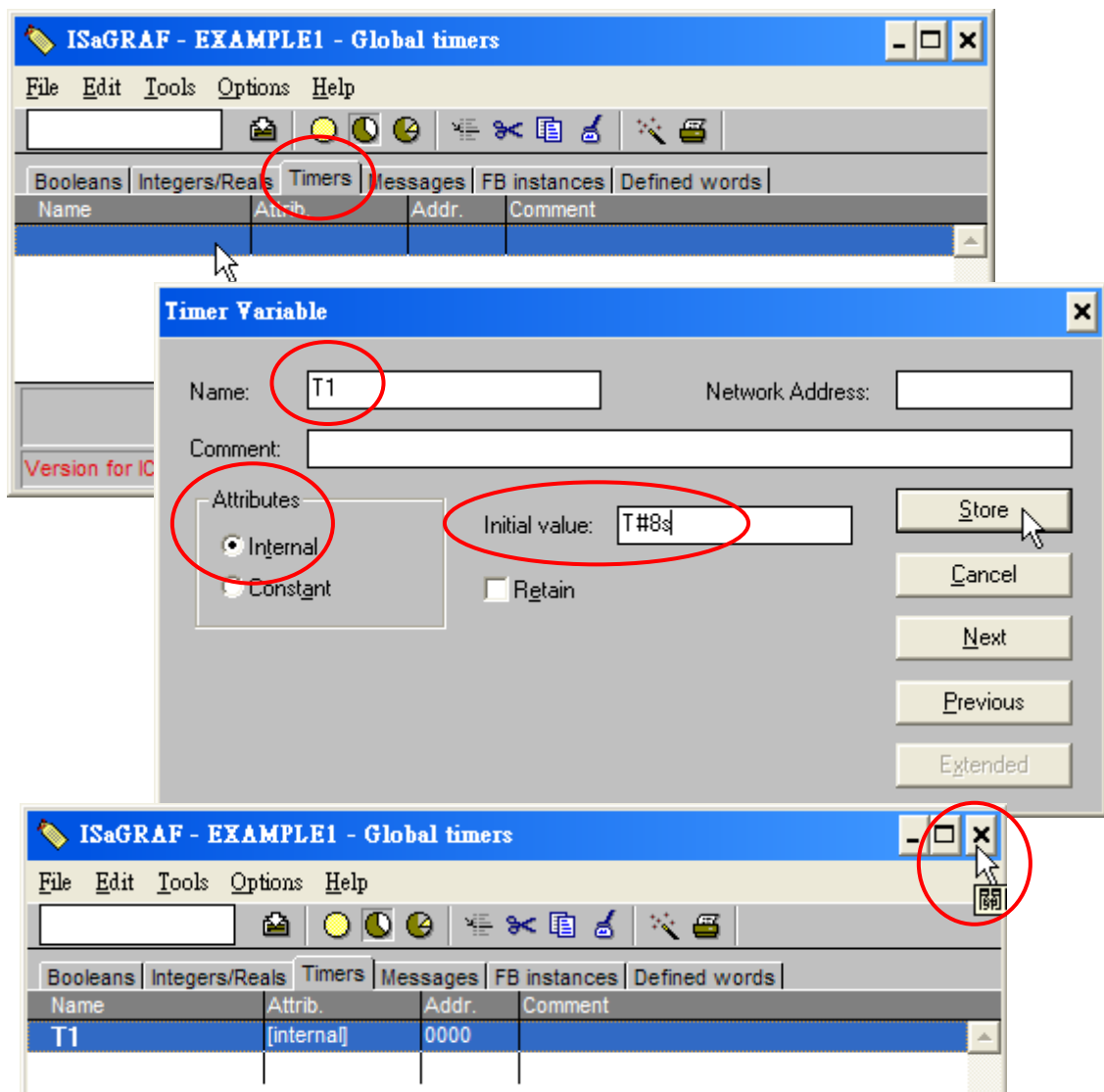

4.1.5 Assign Modbus Network Address No to Variables

The Web HMI will exchange the variable value with the ISaGRAF project if they have assigned the proper “Modbus network address”. The Web HMI only recognizes Modbus No. from 1 to 1024. However other SCADA software may R/W the Modbus No. from 1 to 8191 in the XP-8xx7-CE6.

Variables without assigning Modbus No. will not be available by Web HMI and other SCADA software or HMI devices.

Refer to XP-8xx7-CE6 CD-ROM: [\napdos\isagraf\xp-8xx7-ce6\english-manu\user_manual_i_8xx7.pdf](#) for section 4.1 & 4.2 for detailed information about assigning Modbus network address.

1. Click on “dictionary” icon
2. Click [Tools] > [Modbus SCADA addressing map]
3. Select [Options] > [Decimal] , or it will use Hexadecimal format as default.
4. Click on “00001” on the top window
5. Double click on “OUT01” to attach it to the Modbus No. 1.

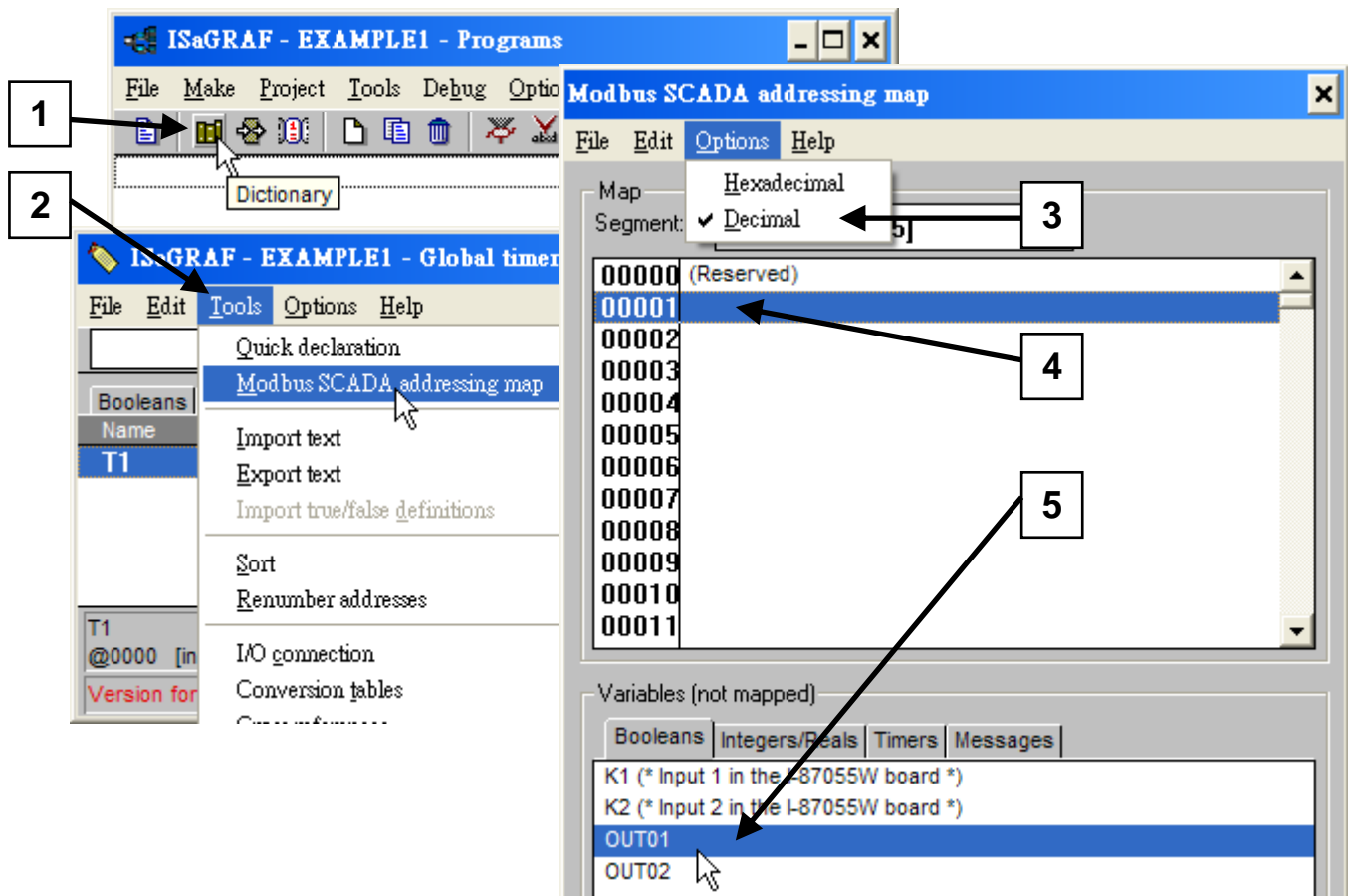

Please follow the same way to assign OUT01 to No.2, K1 to No.11, K2 to No.12 and then Timer variable T1 to No.21. Then we have below window.

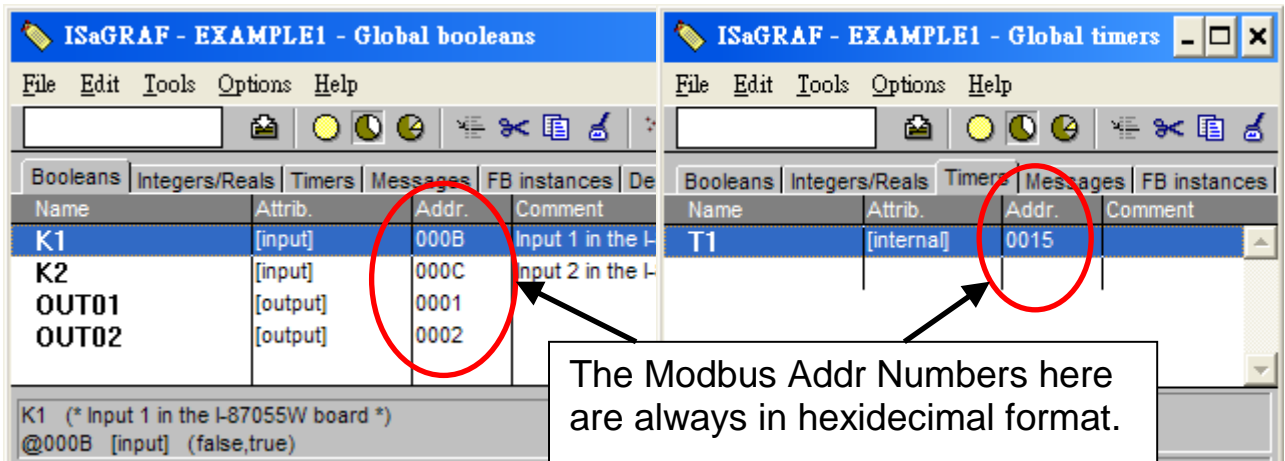

Very Important Notice:

If assign Modbus No. to Long integer or Float or Timer variables, they should occupy two Modbus No. Please refer to XP-8xx7-CE6 CD-ROM: [\napdos\isagraf\xp-8xx7-ce6\english-manu\" user_manual_i_8xx7.pdf](http://napdos\isagraf\xp-8xx7-ce6\english-manu\) - Section 4.2 for detailed information.

4.1.6 Create The LD - "LD1" Program

ISaGRAF will run every program one time in each PLC scan cycle. Programs in the "begin" area will run first, then the "Sequential" area, and last the "End" area. An ISaGRAF cycle runs in the way as the below scheme.

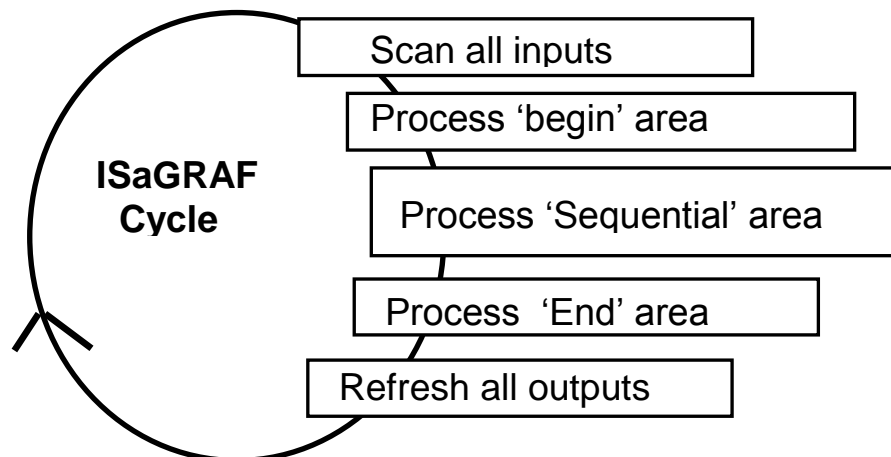

1. Click on the "Create New Program" icon
2. In the "New Program" window, enter the "Name" as "LD1".
3. Click on the "Language" scroll button, select "Quick LD: Ladder Diagram".
4. Make sure the "Style" is set to "Begin: Main Program".
5. You can add any desired text to the "Comment" section for the LD program, but it isn't required.

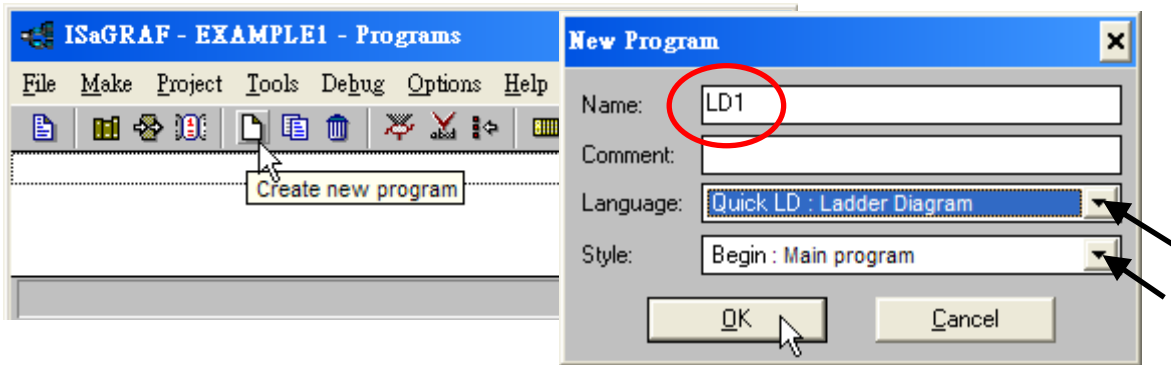

Now we have one program inside this project. Please double click on the "LD1" to get into it.

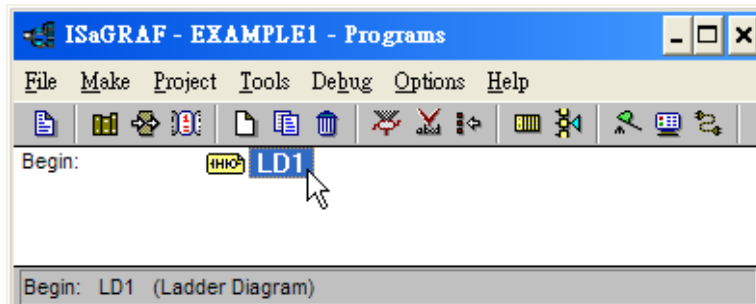

4.1.7 Edit The "LD1" Program

When you double click on the "LD1" name, the "Quick LD Program" window will appear. To start programming our LD program, click on "Edit" from the main menu bar, then click on "Insert Rung" . "Insert Rung" means to insert a basic LD rung just above the current position. **Or, you may just simply click on the "F2 (Contact On The Left)" icon, and the following will appear within the Quick LD Program window.**

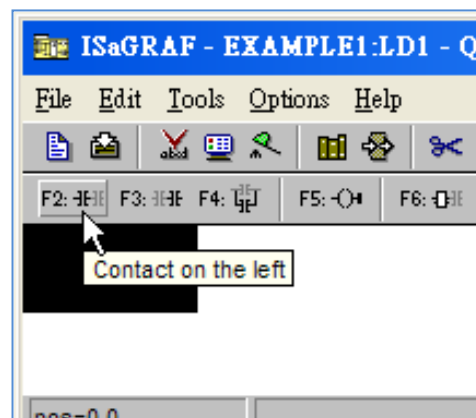
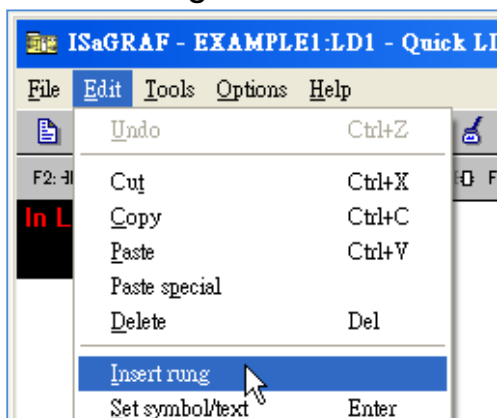

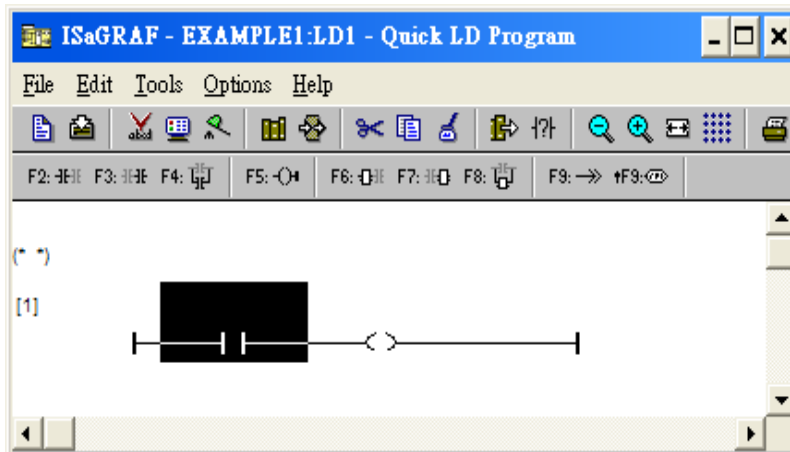

We are going to write the first line of the LD1 program. Move the cursor to the first “contact” and then click on “cut” to delete it.

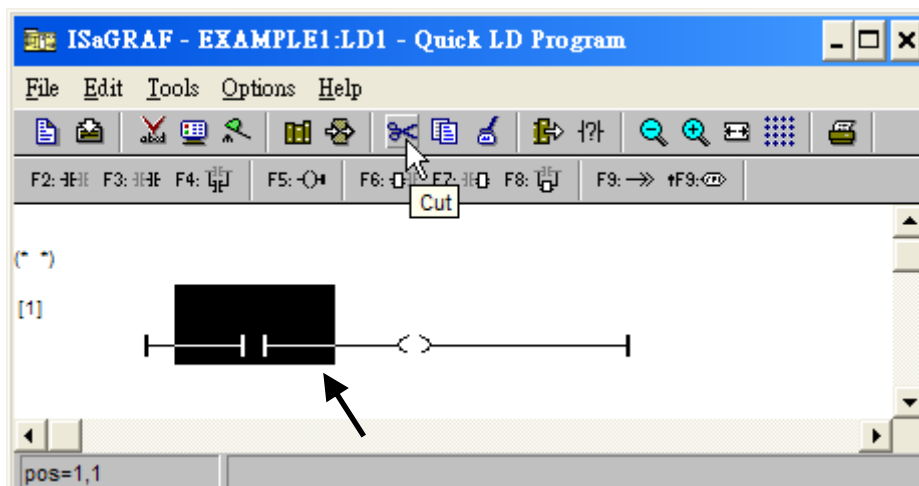

Click on the "F6 (Block on the left)" icon and you will create a block on the left of the “coil”.

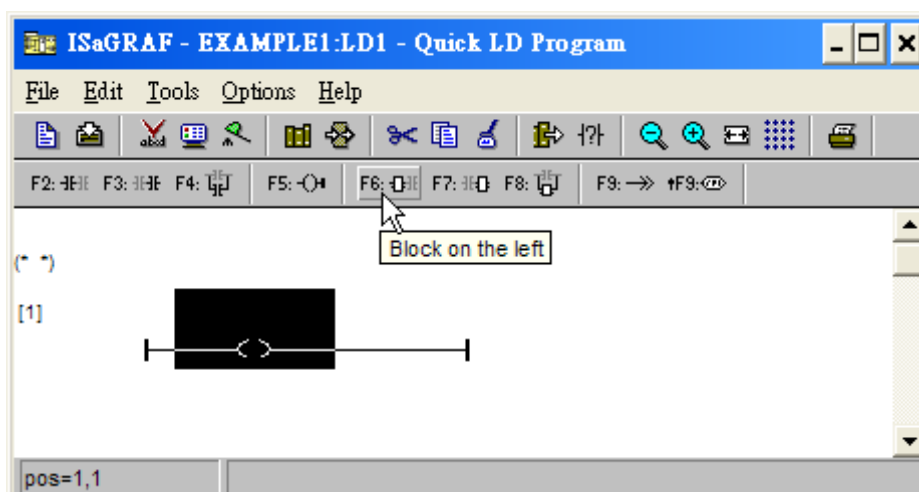

Now we are going to assign the associated variable & constant to each item. Double click anywhere inside of the block and the "Function Block" assignment window appears. Select the "BLINK" type function block. To learn how the

"BLINK" function operates you can click on the "Info" button for a detailed explanation of its functionality

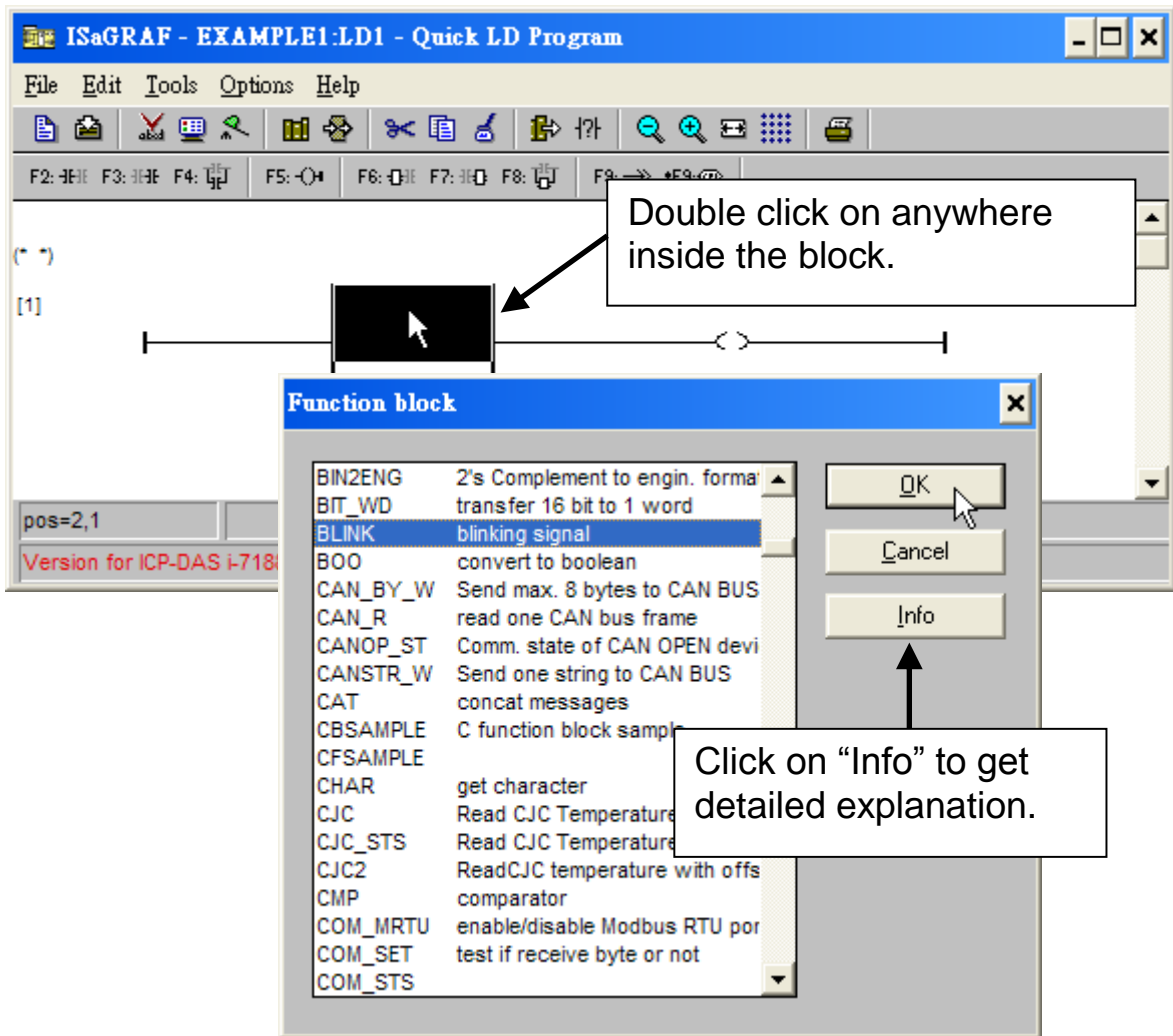

Now move your cursor to the left of the parameter "CYCLE" of the "BLINK" block.

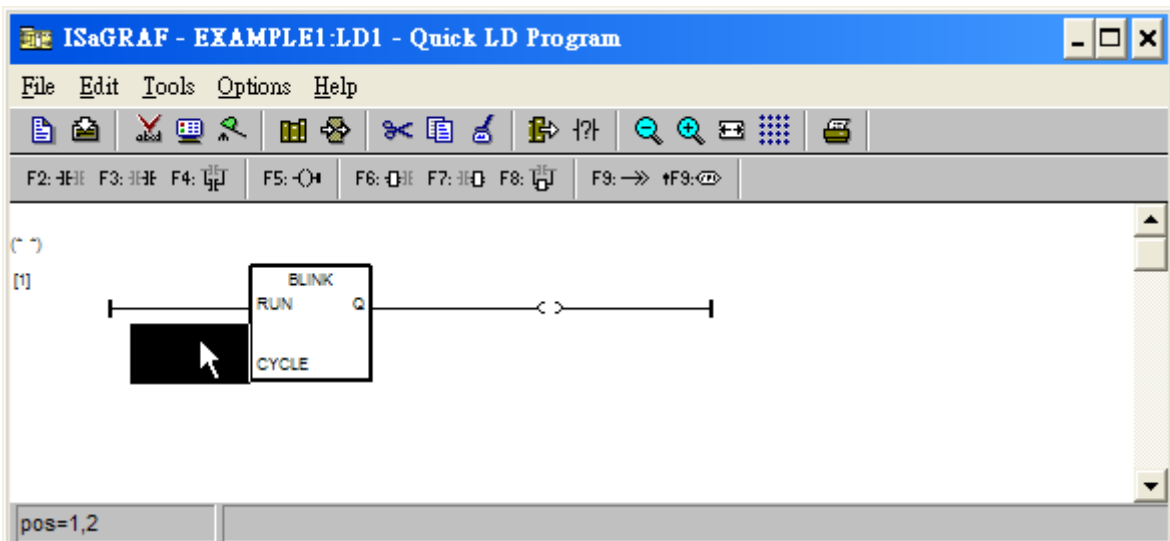

Double click on it, select “Timer” and then double click on variable name - “T1”.

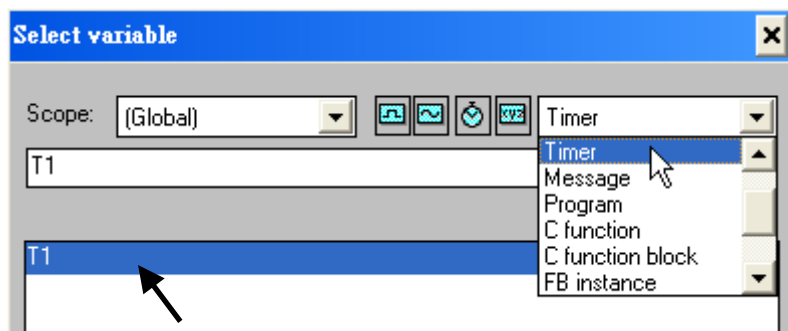

Move your cursor to the “coil”. Double click on it, select “Boolean” and then double click on variable name – “OUT01”.

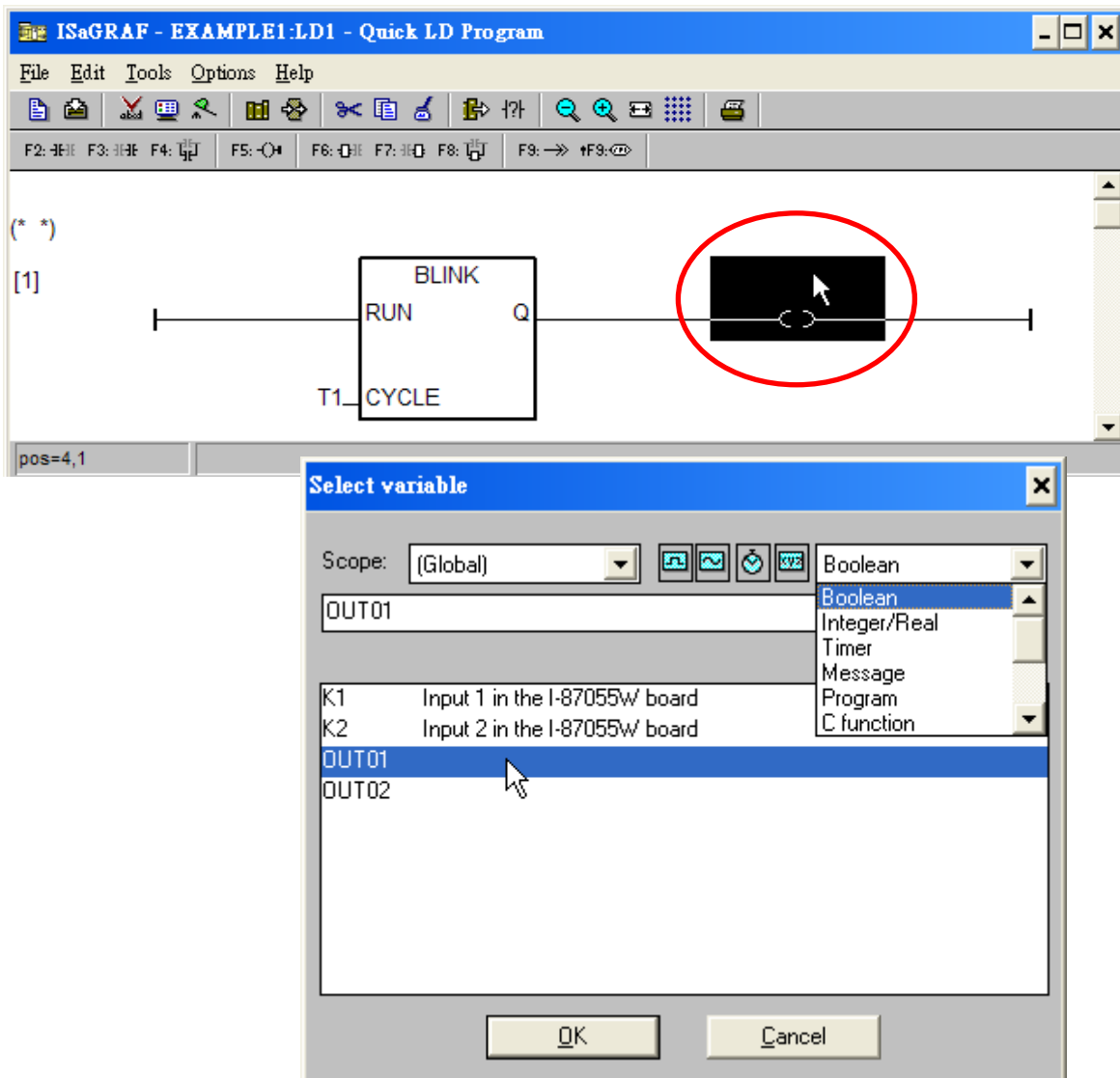

Now we have finished our Ladder code, click on “Save” and then click on “X” to exit.

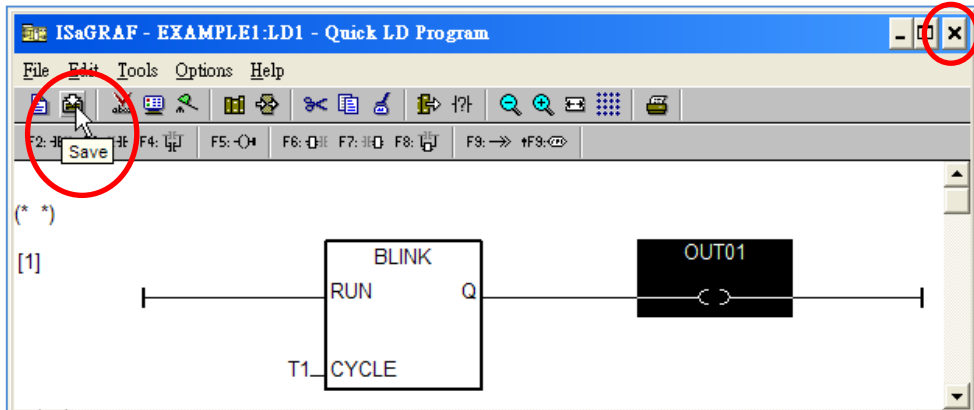

4.1.8 Connecting The I/O

We have defined variables name of “OUT01” , “OUT02” as “output” attribution, while “K1” & “K2” as “input” attribution in [step 4.1.4](#). These “input” & “output” variables should be map to physical I/O in the controller before they can work.

To do that, click on “I/O connection” to get into the I/O connection window. Double click on the first slot column (Please make sure your I-87055W I/O board is plug in slot 1 of the XP-8xx7-CE6) & then check on the “Equipments” & double click on the “I_87055: 8 CH. DI & 8 CH. DO ”. Click “OK”.

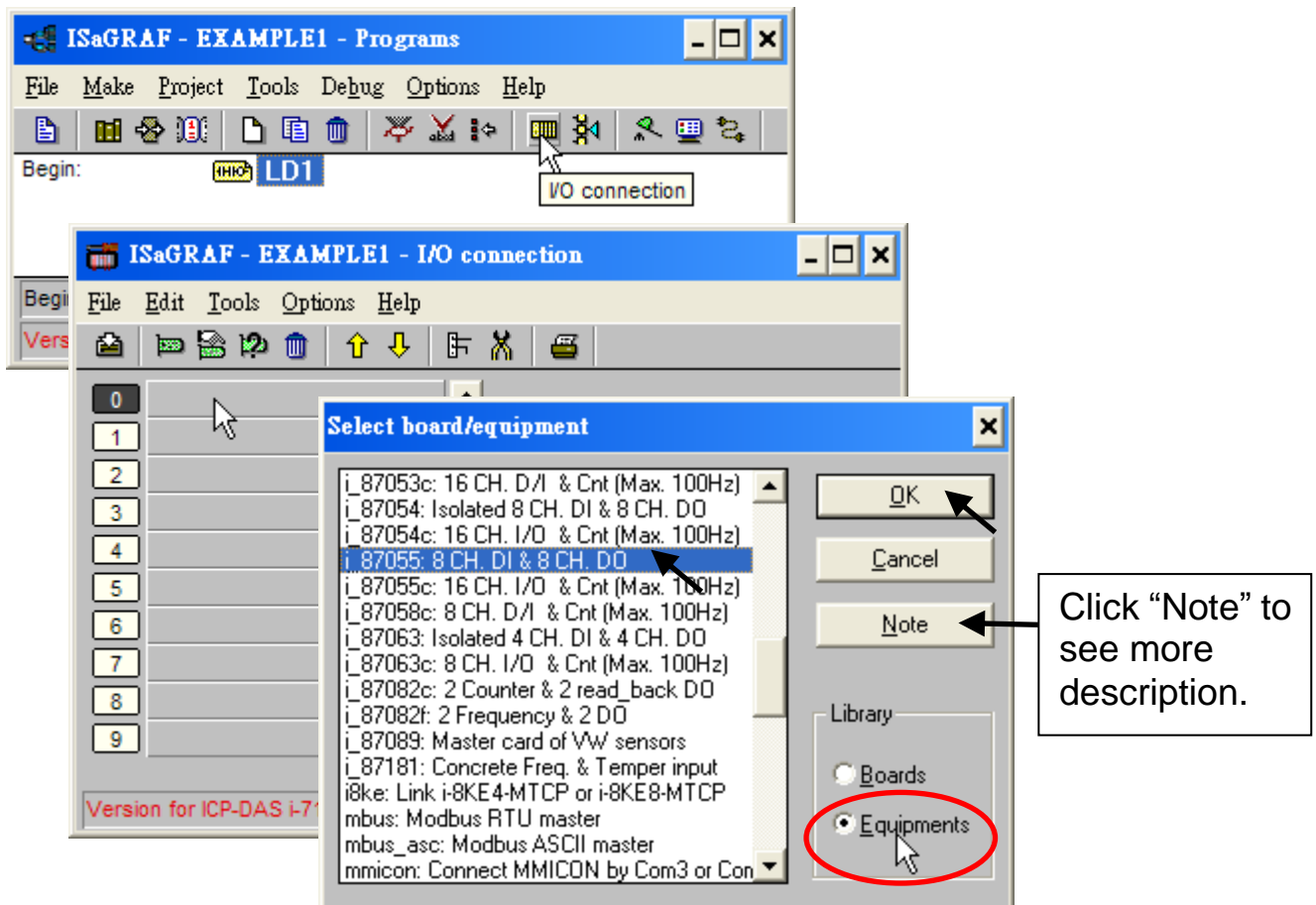

Then we have the screen below. (If you don't have the I-87055W, you may click the “Real / Virtual board” to make it become virtual board.)

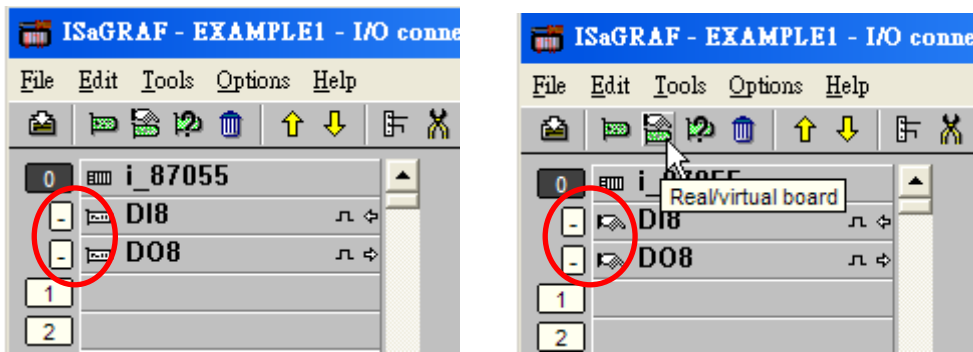

To map input variables “K1” & “K2” to the input channel No. 1 & 2 of the “I-87055”, double click on the channel 1 and then click on “Connect” .Then click on “Connect” again to connect channel 2.

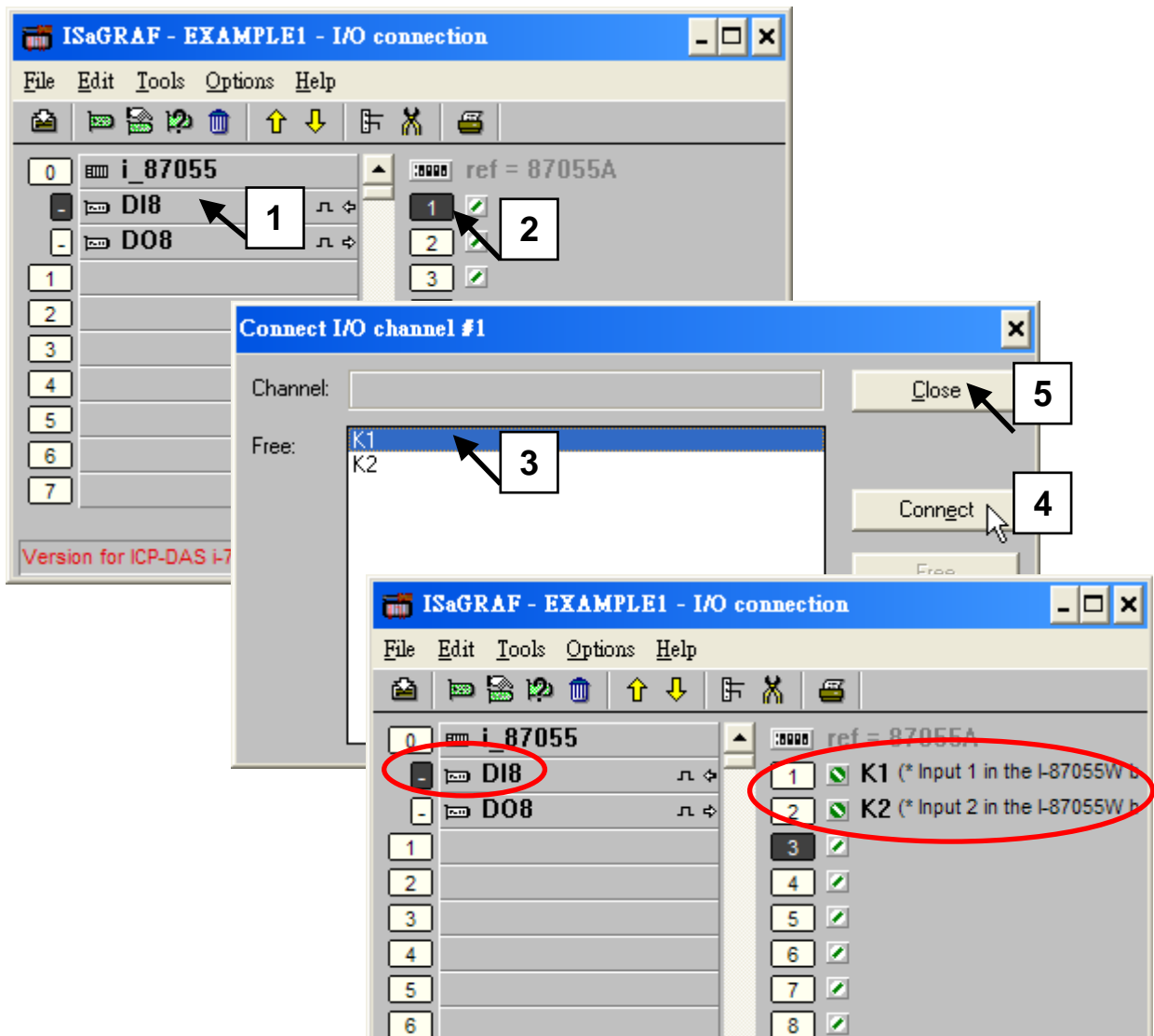

By the same way, please connect “OUT01” , “OUTPUT02” to output channel 1 to 2. Then we have below window. Click on “Save” and then exit.

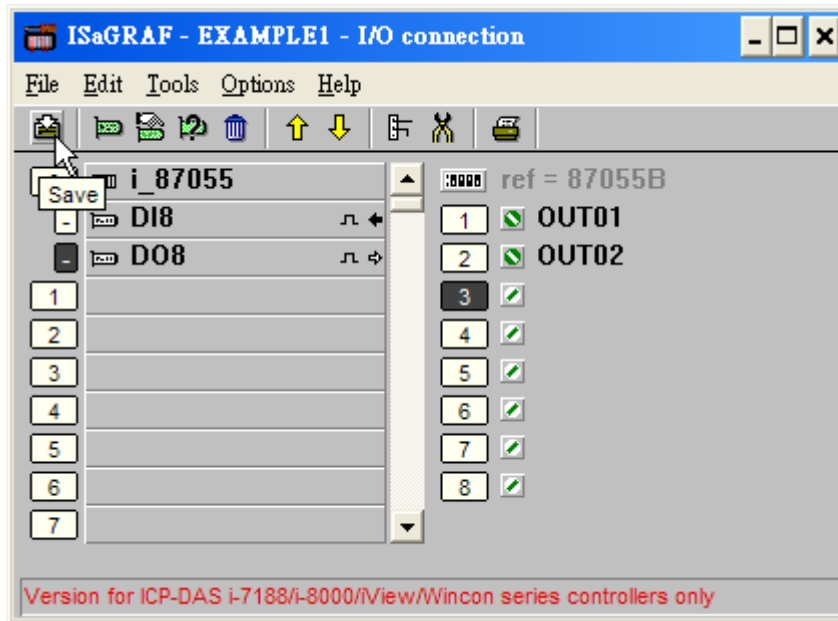

IMPORTANT NOTICE:

1. I/O Slots 1 through 7 are reserved for REAL I/O boards that will be used in the XP-8xx7-CE6. You can use slot No. 8 and above for additional functionality.
2. All of the variables with “Input” and “Output” attribute MUST be connected through the I/O connection as described above for any program to be successfully compiled. Only the Input and Output attributed variables will appear in the "I/O Connections" window. In this example we have only 2 boolean output variables - OUT01, OUT02 and 2 boolean input variables – K1 & K2.

4.2 Compiling & Simulating The Example Project

For ANY AND EVERY ISaGRAF program to work properly with any of the ISaGRAF PACs (ISaGRAF XPAC, WinPAC, ViewPAC, μ PAC, iPAC...) controller systems, it is the responsibility of the programmer to properly select the correct "Compiler Options". You MUST select the "ISA86M: TIC Code For Intel" option as described below.

To begin the compilation process, first click on the [MAKE] > [Compiler Options] as shown below.

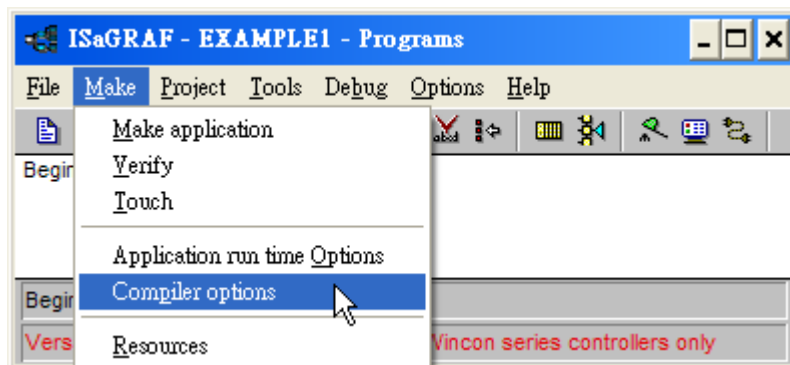

The "Compiler Options" window will now appear. Make sure to select the options as shown below then press the "OK" button to complete the compiler option selections.

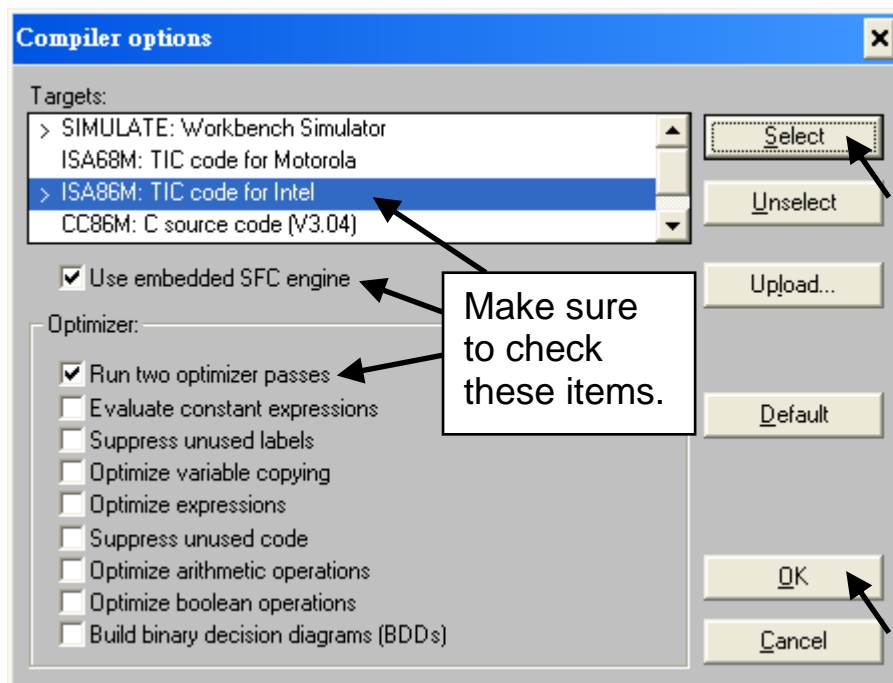

Compiling error result in different ISaGRAF Version, please refer to [appendix H](#) of this manual.

TIME TO COMPILE THE PROJECT!

Now that you have selected the proper compiler options, click on the "Make Application Code" icon to compile the example project. If there is no compiler error detected during the compilation process, CONGRATULATIONS, you have successfully created our example program.

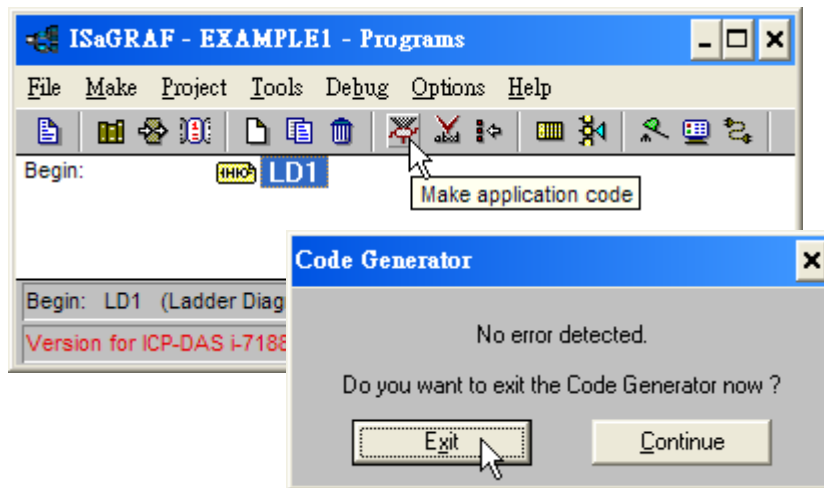

If errors are detected during the compilation process, just click on the "CONTINUE" button to review the error messages. Return to the Project Editor and correct the errors as outlined in the error message window.

TIME TO SIMULATE THE PROJECT!

If the compilation is OK, you may simulate the project on the PC to see how the program works without the controller. To do that, click on the "Simulate" icon.

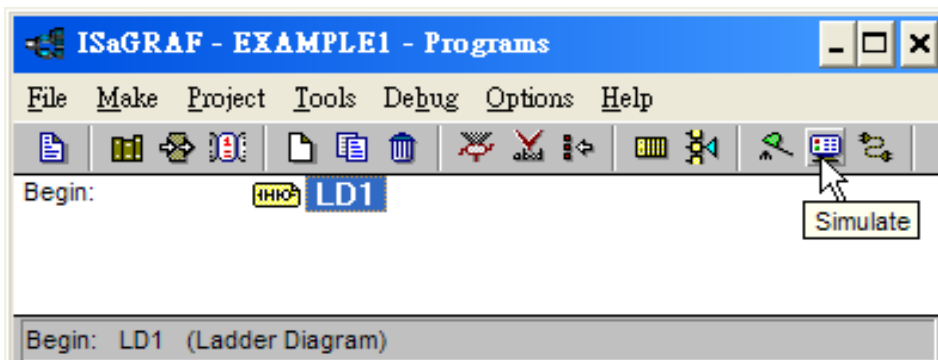

When you click on the "Simulate" icon three windows will appear.

- "ISaGRAF Debugger"
- "ISaGRAF Debug Programs"
- "I/O Simulator"

If the I/O variable names you have created DO NOT appear in the I/O simulator window, just click on the [Options] > [Variable names] and the variable names you have created will now appear next to each of the I/O's in the simulator window.

In the "ISaGRAF Debug Program" window, double click on the "LD1" where the cursor below is positioned. This will open up the ISaGRAF Quick LD Program window and you can see the LD program you have created.

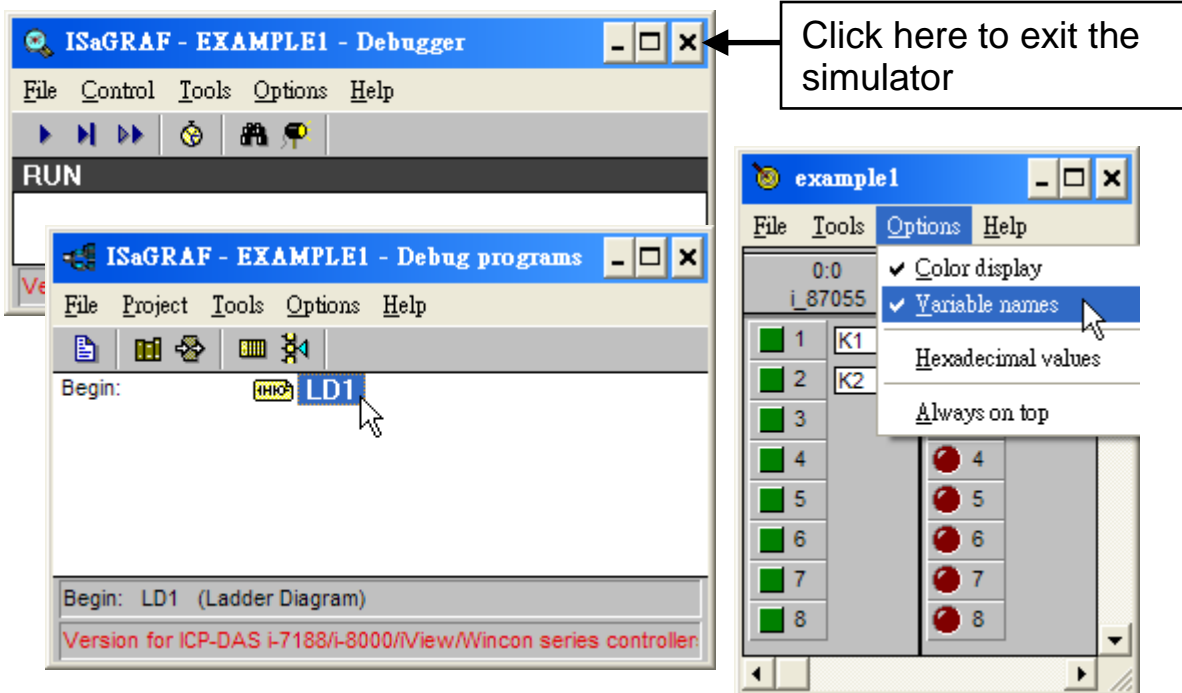

RUNNING THE SIMULATION PROGRAM

When you double click on "LD1" in the "ISaGRAF Debug Programs" window, the follow window should appear.

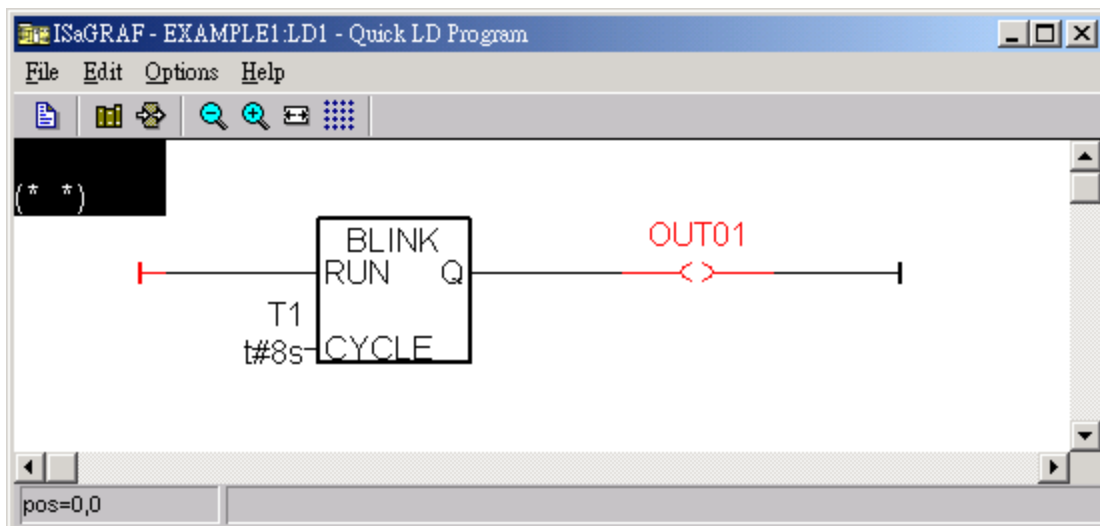

You can see outputs "OUT01" will blink in the period of 8 seconds.

You can adjust the "T1" variable while the program is running. To accomplish this, click on the "Dictionary" icon which will open the "ISaGRAF Global Variables" window as shown in the first two pictures below. Click on "Timers" tab and then double click on "T1" to change the timer value to "T#4000ms" (this means 4000 ms). Then click on "Write".

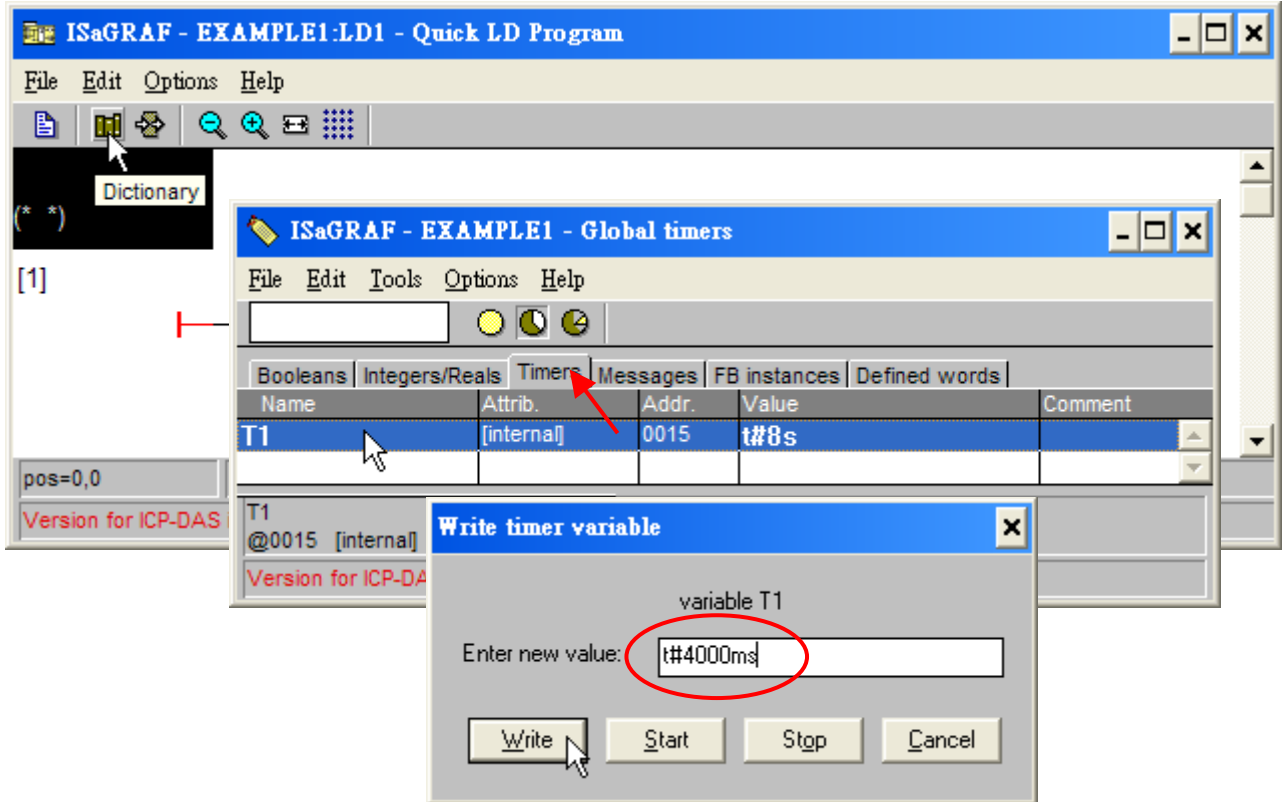

Now we are going to simulate the "K1" & "K2" input. Click on "K1" using the left button of the mouse.

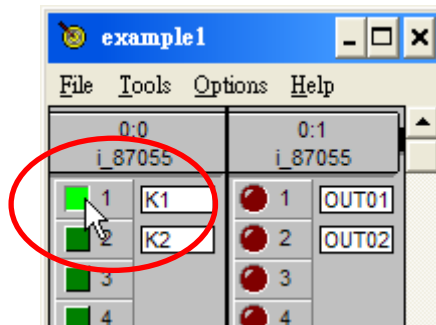

To exit simulation, please close the "debugger" window.

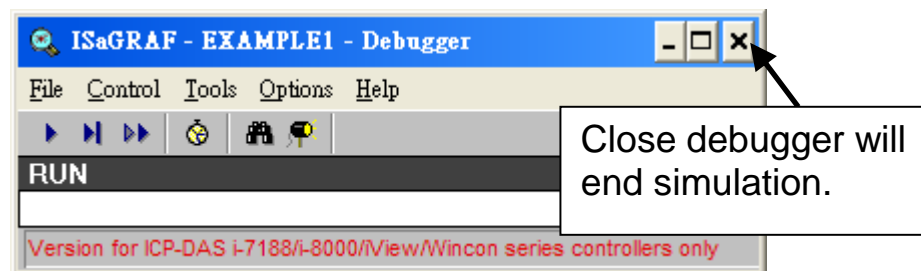

4.3 Download & Debug The Example Project

We have two ways to download the project to the XP-8xx7-CE6.

1. Using Ethernet cable
2. Using RS-232 cable

Here will show you the RS-232 way. (Please refer to [Section 3.2.3.1](#) if you would like to download the project via Ethernet)

WIRING THE HARDWARE

To begin this process, please install the hardware as below. The RS-232 cable wiring should be as below figure.

Please make sure the “Modbus RTU Slave Port” is set as COM2 (refer to [Appendix A.2](#)), or it can only be download via Ethernet.

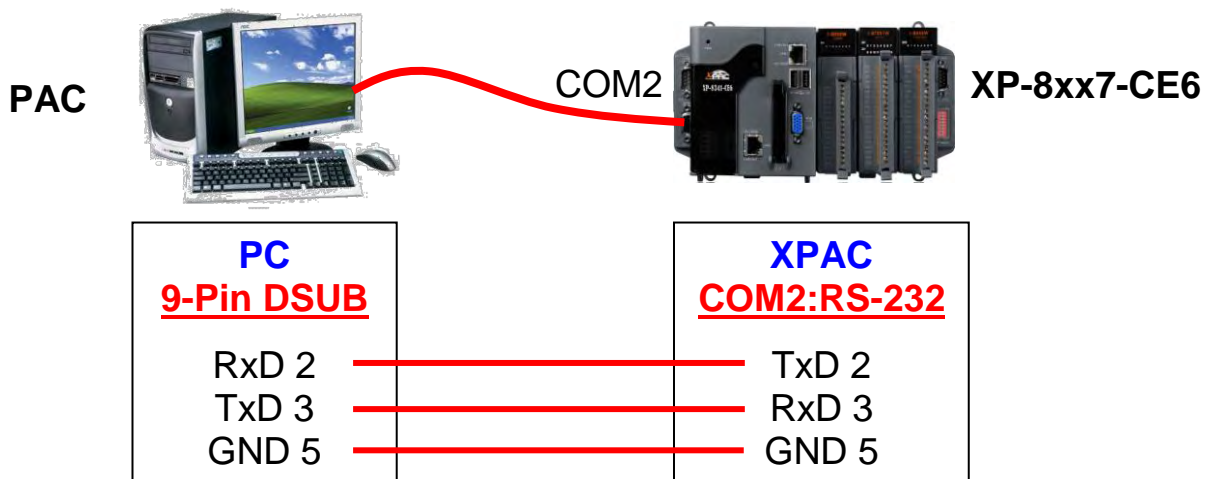

This section lists how to download the ISaGRAF program via RS-232 cable. However user may also use Ethernet cable to download program to the XP-8xx7-CE6 (please refer to [section 3.2.3.1](#))

SETUP LINK PARAMETERS

Click on the "Link Setup" icon in the "ISaGRAF Programs" window.

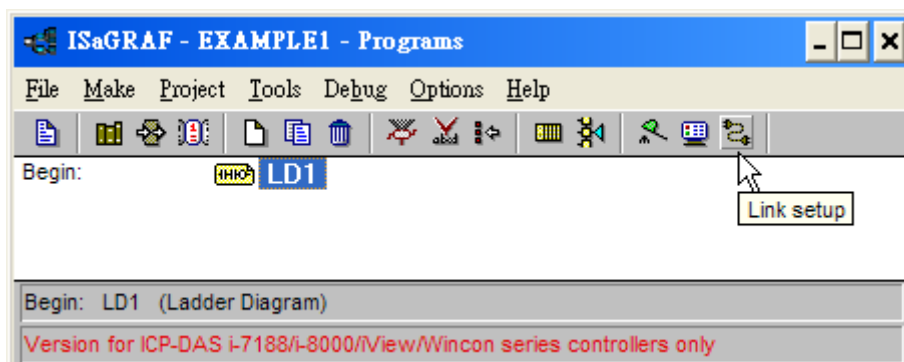

When you click on the "Link Setup" icon, the following window will appear. Please set the proper value.

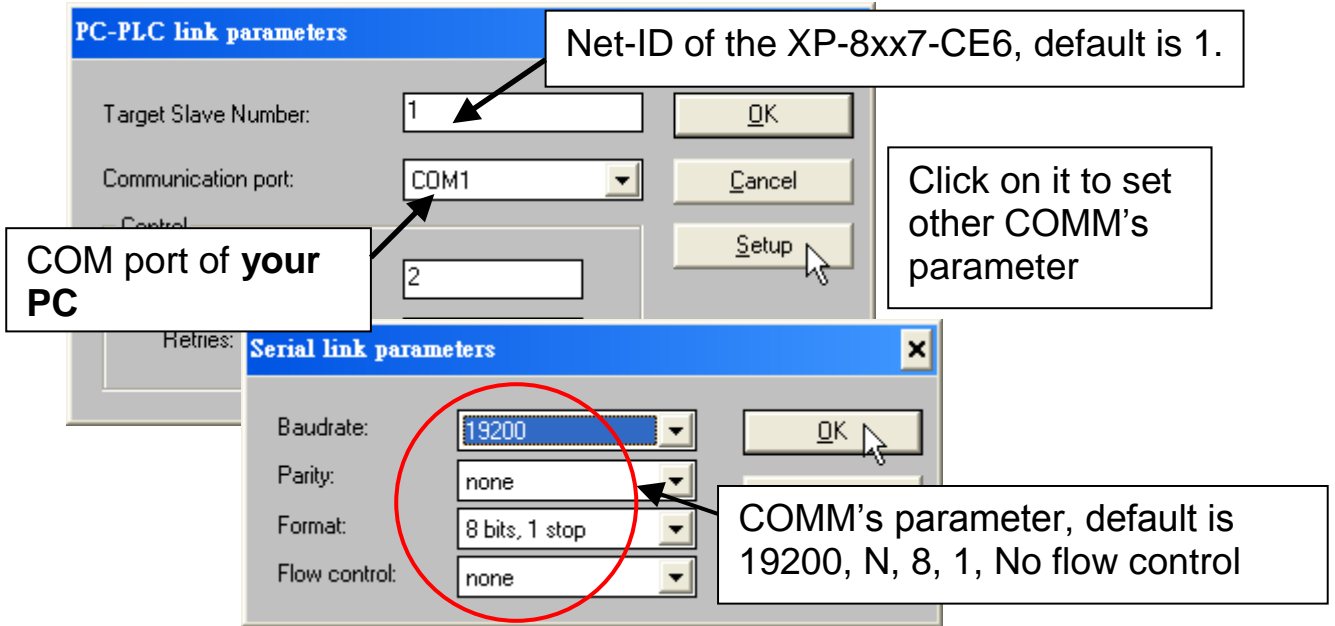

The RS-232 communication parameters for the target XP-8xx7-CE6 controller MUST be set to the same serial communication parameters for the development PC. For XP-8xx7-CE6 controllers (serial port communications), the default parameters for COM2 (RS-232) port are:

Baudrate:	19200
Parity:	none
Format:	8 bits, 1 stop
Flow control:	none

(Please refer to [Appendix A.2](#) to setup COM2 as Modbus RTU slave port)

DOWNLOADING THE EXAMPLE PROJECT

Before you can download the project to the controller, you must first verify that your PC and the controller system are communicating with each other. To verify proper communication, click on the "Debug" icon in the "ISaGRAF Programs" window as shown below.

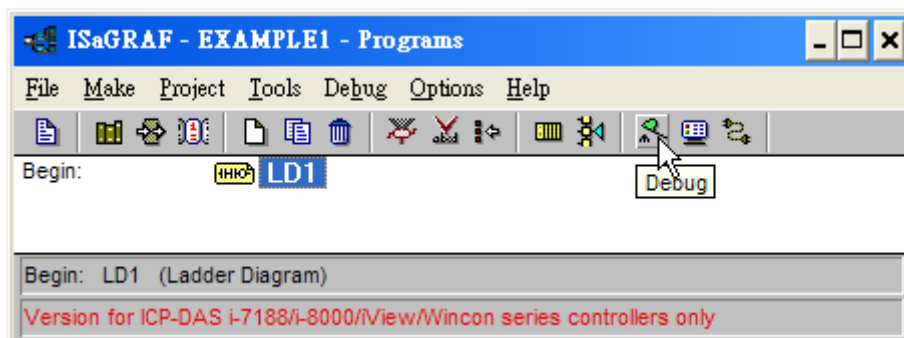

If the development PC and the XP-8xx7-CE6 controller system are communicating properly with each other, the following window displayed below will appear (or if a program is already loaded in the controller system, the name of the project will be displayed with the word "active" following it).

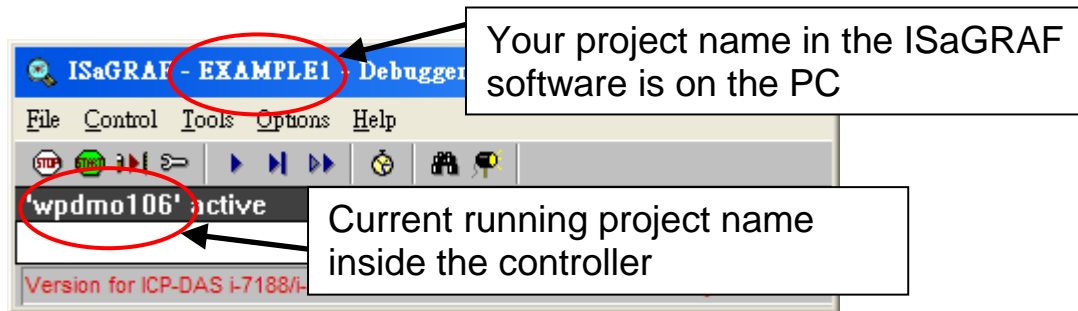

If the message in the "ISaGRAF Debugger" says "**Disconnected**", it means that the development PC and the controller system have not established communications with each other.

The most common causes for this problem is either the serial port cable not being properly configured, or the development PC's serial port communications DO NOT match that of the XP-8xx7-CE6 controller system.

You may have to either change the serial port communication settings for the development PC (which may require changing a BIOS setting) or change the "Serial Link Parameters" in the ISaGRAF program.

If there is a project already loaded in the controller system you will need to stop that project before you can download the example project. Click on the "STOP" icon as illustrated above to halt any applications that may be running.

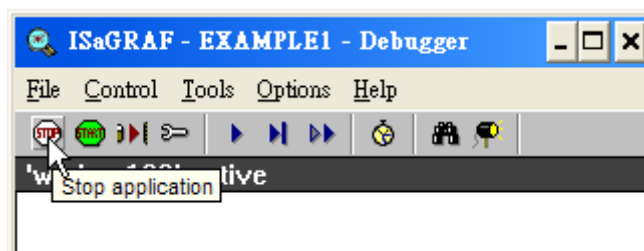

STARTING THE DOWNLOADING PROCESS

Click on the "Download" icon from the "ISaGRAF Debugger" window.

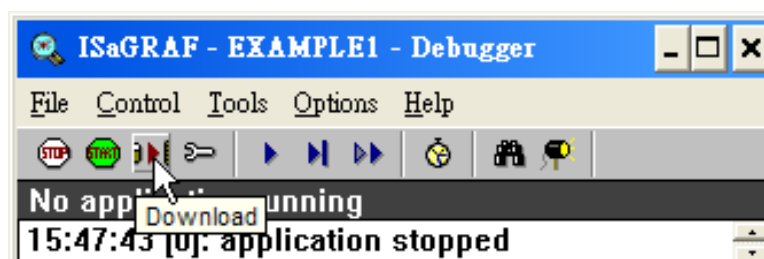

Then click on "ISA86M: TIC Code For Intel" from the "Download" window as shown below.

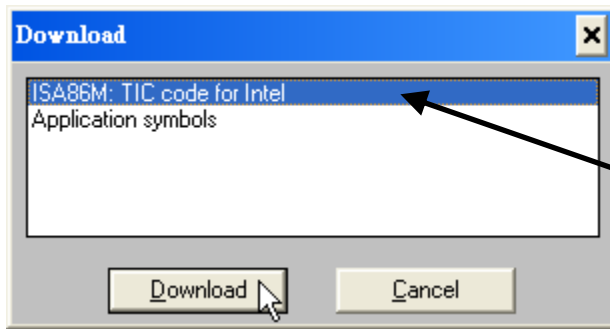

If "ISA86M: TIC code for Intel" is not found here, that means the compiler option - "ISA86M: TIC code for Intel" is not checked. Please refer to section 4.2 to check it & re-compile the project again.

The example project will now start downloading to the XP-8xx7-CE6 controller system. A progress bar will appear in the "ISaGRAF Debugger" window showing the project downloading progress.

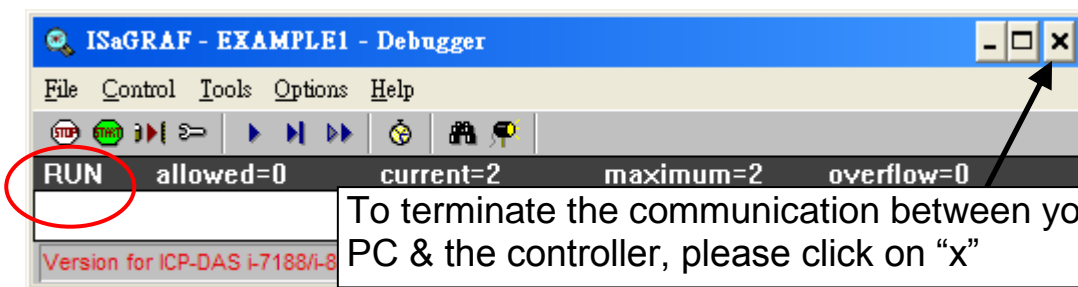

To terminate the communication between your PC & the controller, please click on "x"

RUNNING THE EXAMPLE LD PROGRAM

You can observe the real time I/O status from several ISaGRAF windows while you are running the example project.

One of the windows is the "I/O Connections" window, which shows each of the inputs and outputs as assigned. Click on the "I/O Connections" icon in the ISaGRAF Debugger window to open the "I/O Connections" screen. You may switch ON/OFF the D/I on the front panel of the I-87055W I/O board to see what happens about "K1" & "K2"

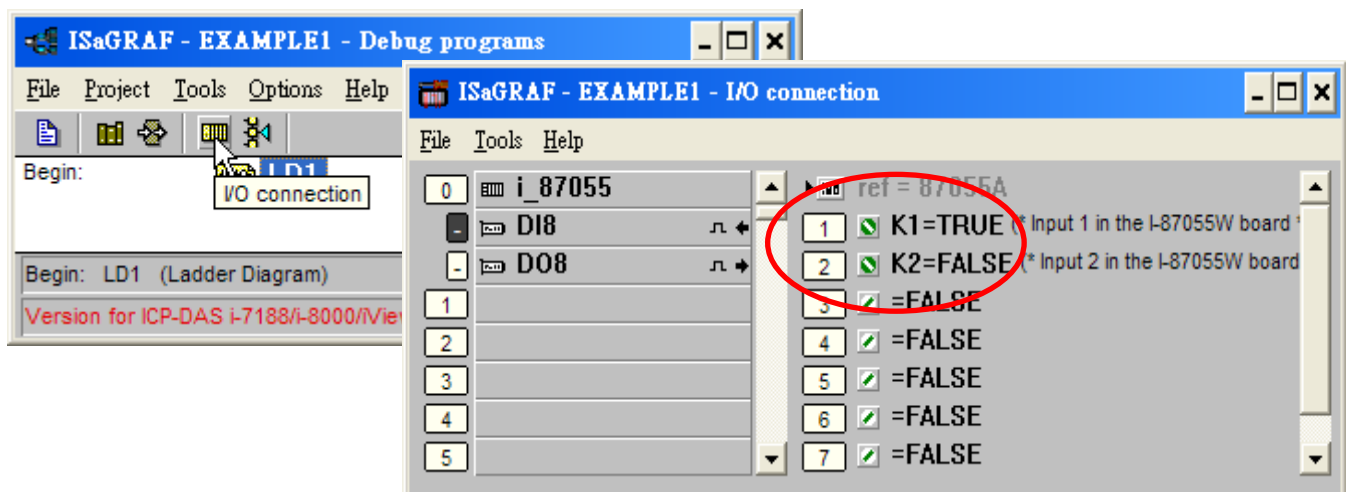

Also, you may click on "Dictionary" icon to see the real time variable state.

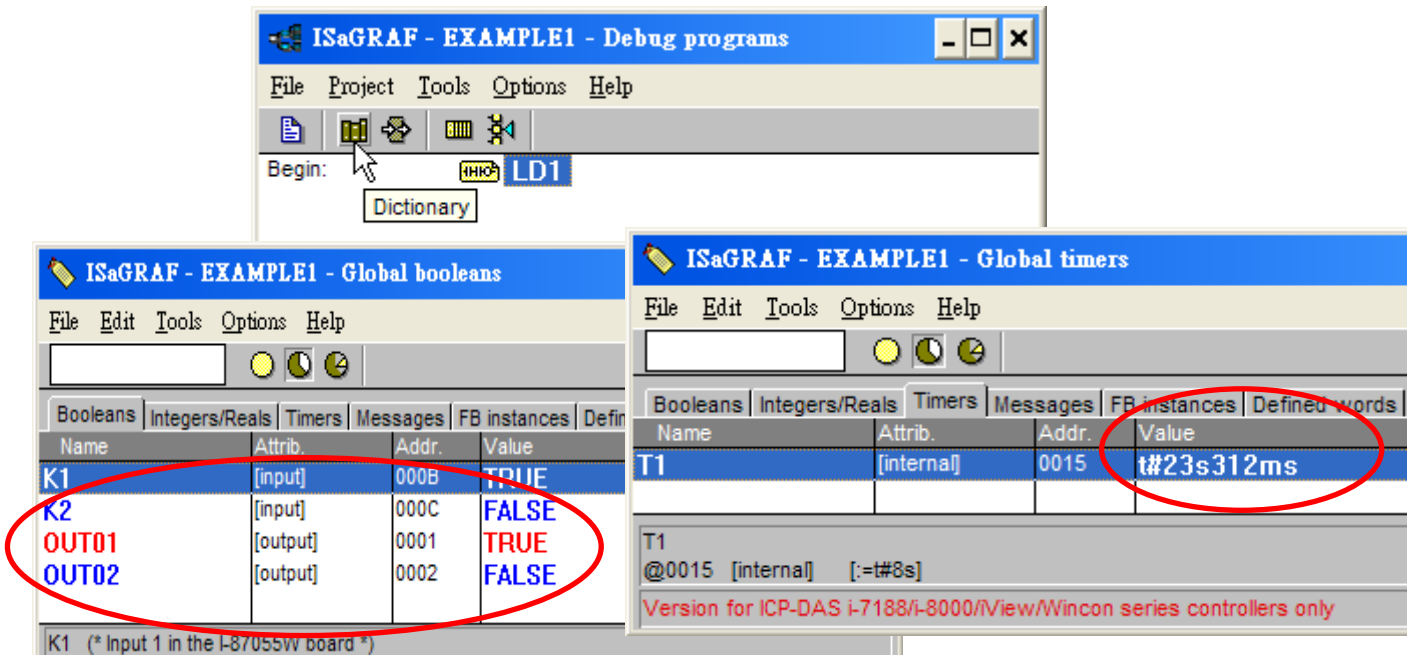

Another VERY helpful window you can open is the "Quick LD Program" window. From this window you can observe the LD program being executed in real time.

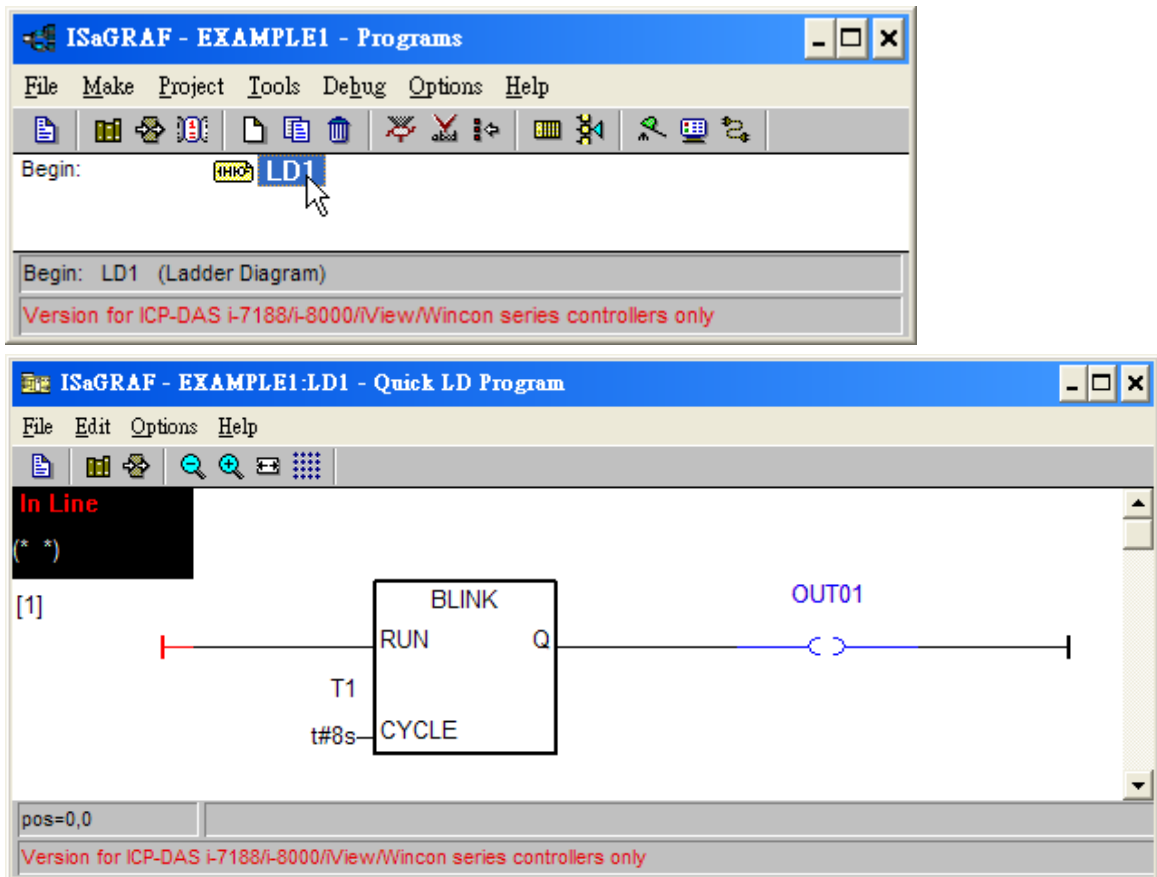

4.4 Design The Web Page

After finishing the ISaGRAF project & download it to the XP-8xx7-CE6, we are going to design the Web Page for this ISaGRAF project.

If you haven't practiced "Setting Up A Web HMI Demo" listed in the [Chapter 3](#), it's better to do it once to get familiar with it.

We will use "Microsoft Office FrontPage 2003" (or advanced version) to build web pages in this manual. User may choose your prefer web page editor to do the same thing.

You may refer to the finished web pages of this example in the XP-8xx7-CE6 CD-ROM at design time. However it is better to do it one time by yourself to get more understanding.

4.4.1 Step 1 – Copy The Sample Web HMI pages

This is a sample Web HMI pages in the XP-8xx7-CE6 CD-ROM:

[\napdos\isagrafxp-8xx7-ce6\xpce6-webhmi-demo\sample\](#)

Please copy this "sample" folder to your drive and rename it, for example, "example1".

The basic Web HMI files include 2 folders and 3 DLL files and 4 htm files as below.

./img/	(default image files - *.jpg , *.bmp , *.gif)
./msg/	(default message files – wincon.js & xxerror.htm)
whmi_filter.dll	(three DLL files)
login.dll	
main.dll	
index.htm	(first default page)
login.htm	(the Web HMI welcome page)
menu.htm	(the page-menu page, normally on the left on the Internet Explorer)
main.htm	(first page when successfully login)

User may put his own image files into the folder named as "user_img". And put user-defined java script file or css file into the folder named as "user_msg". Other folder name is not acceptable by the Wincon Web HMI.

The “index.htm” file is the default entry page of the web server. **User should not modify it.** The “index.htm” re-directs to the “login.htm” file in 1 to 2 second when someone visits the XP-8xx7-CE6 via the Internet Explorer.

User may modify the “login.htm” , “menu.htm” & “main.htm” to fit his own need. We will only modify the “main.htm” in this example.

4.4.2 Step 2 – Building The Main.htm

Please run the Microsoft Office FrontPage 2003 (or advanced version) and open the “main.htm”.

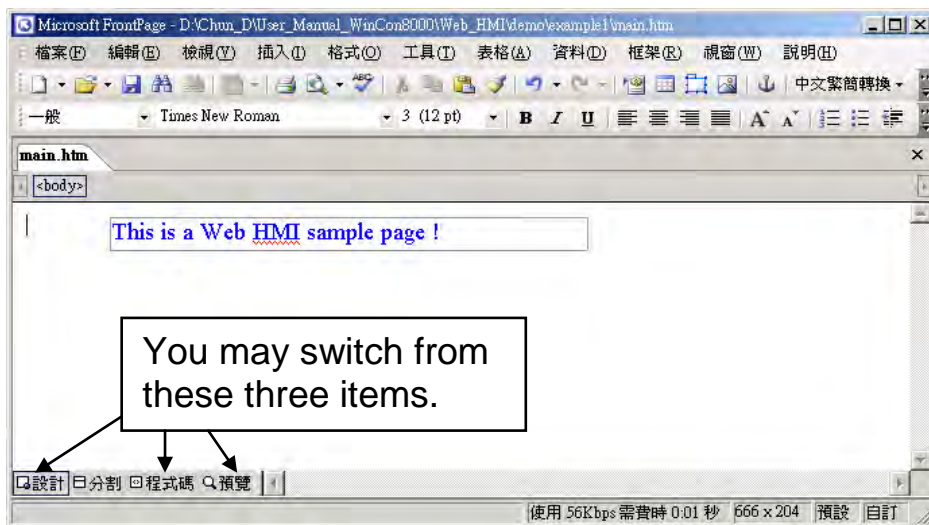

Please switch the window to design the page.
Please insert a layout object – “Layer” as below.

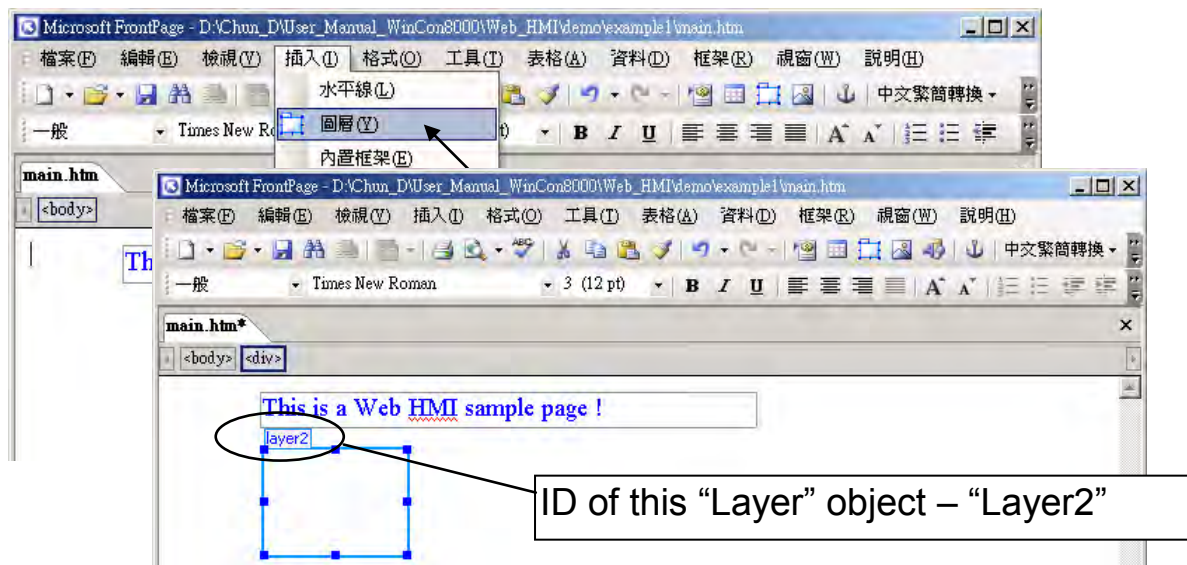

Click inside this “Layer” and then insert one another layer inside it as below. Please enter “K1” into the new created “Layer”.

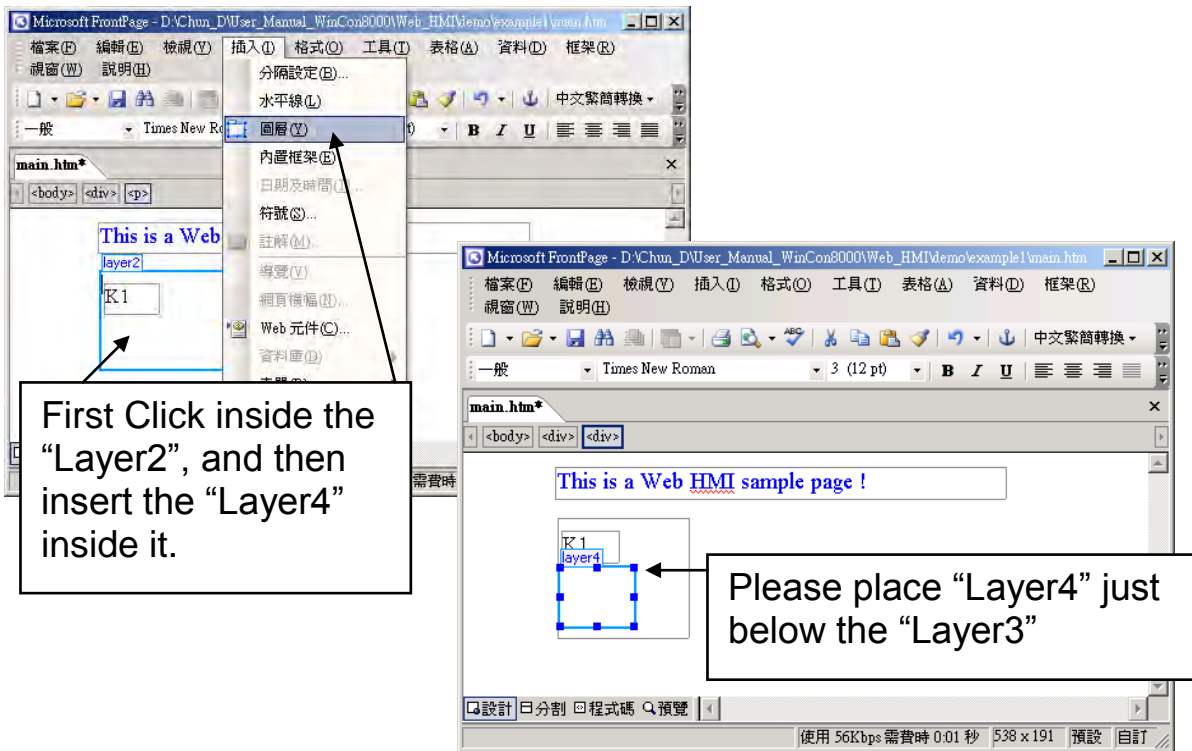

Follow the same former steps to insert one another “Layer” to be in just below the “Layer3” as below.

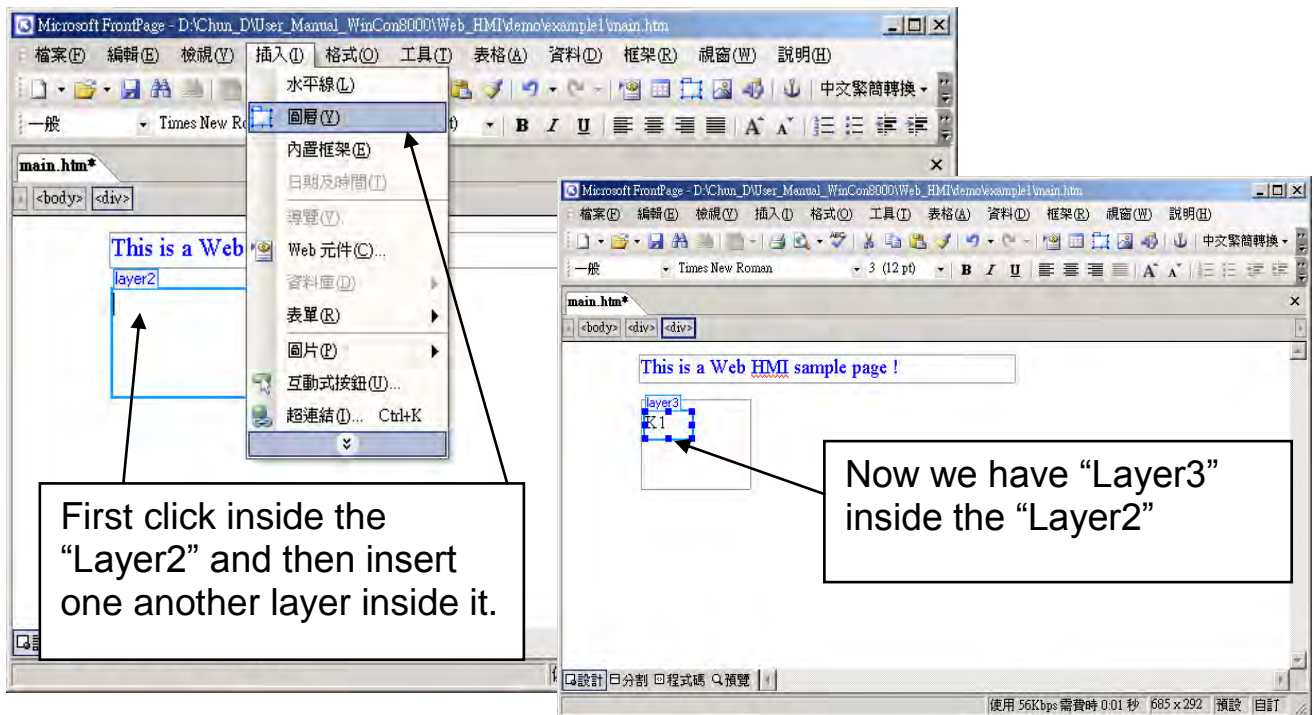

Inside the “Layer4”, we are going to insert one image file to it as below. The image file name is “.img/big_Tcircle_red0.jpg”. Please browse to the correct folder in your hard driver. Here we use “example1/img/” in this example.

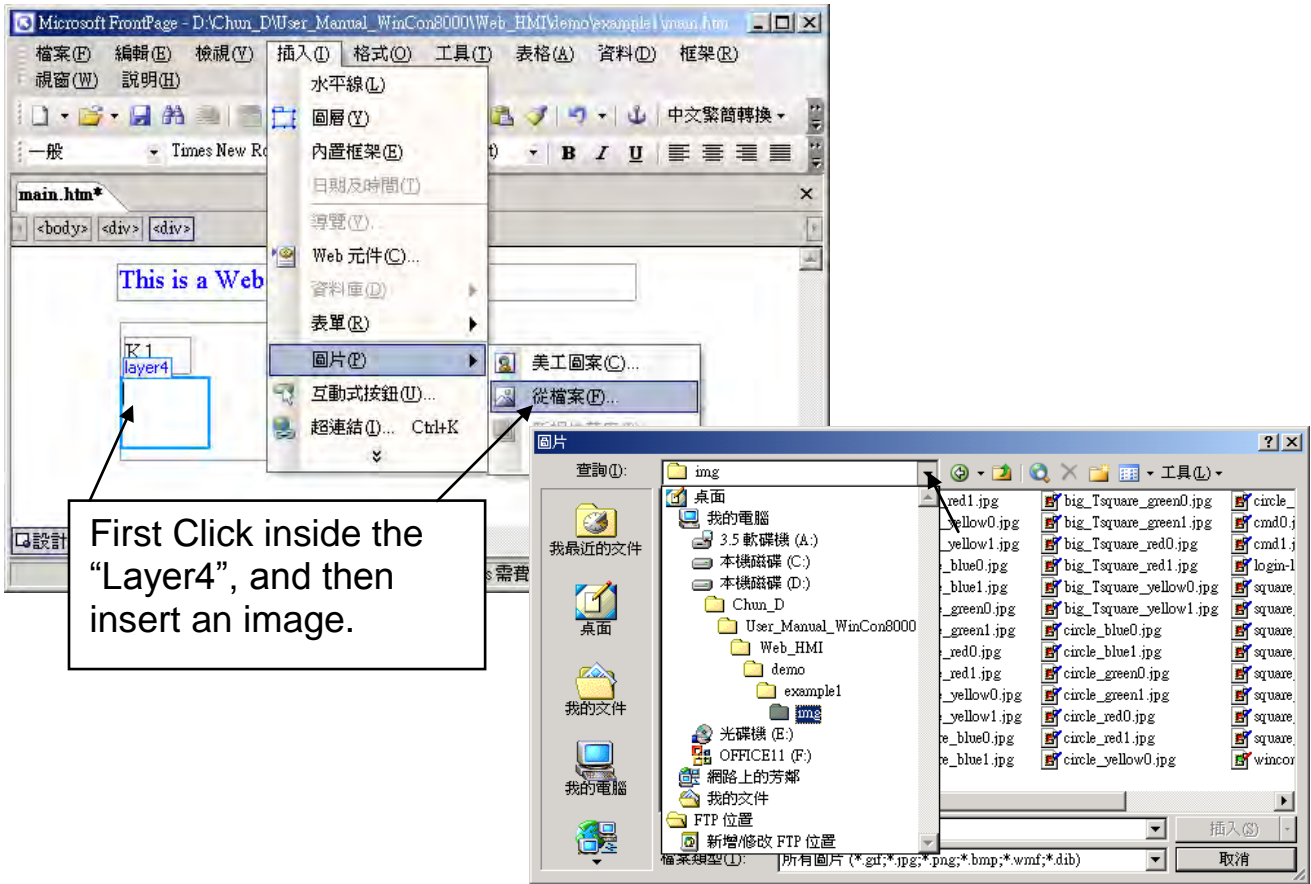

You will see a window as below.

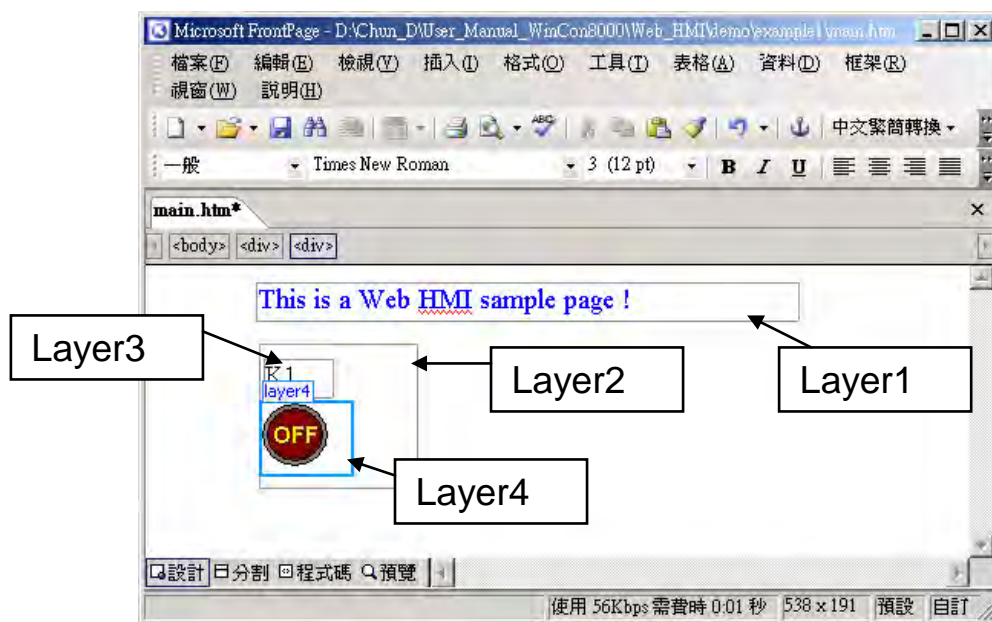

Please follow the similar steps to insert one another “Layer5” and one “Layer6” with a “K2” symbol inside it, and also a “Layer7” with a “OK” symbol inside it as below. We will use “K1” to display the state of the first input of the I-87055W board, and “K2” for its second input.

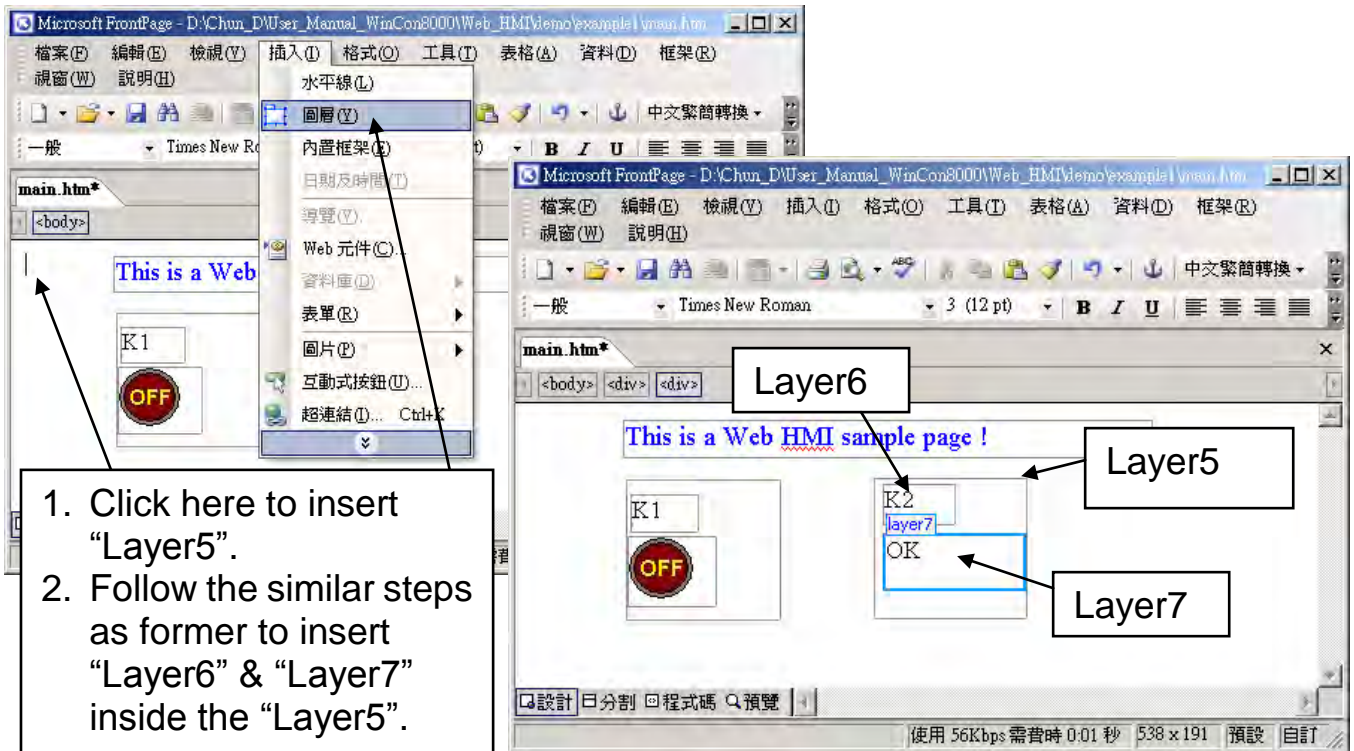

Please follow the similar steps to insert “OUT01” & “OUT02” as below. The OUT01 uses “./img/circle_blue0.jpg” as its image source, while OUT02 using “./img/cmd0.jpg”. We will use OUT01 to display the state of the first output of the I-87055W board, while “OUT02” is for controlling and displaying the second output of the I-87055W.

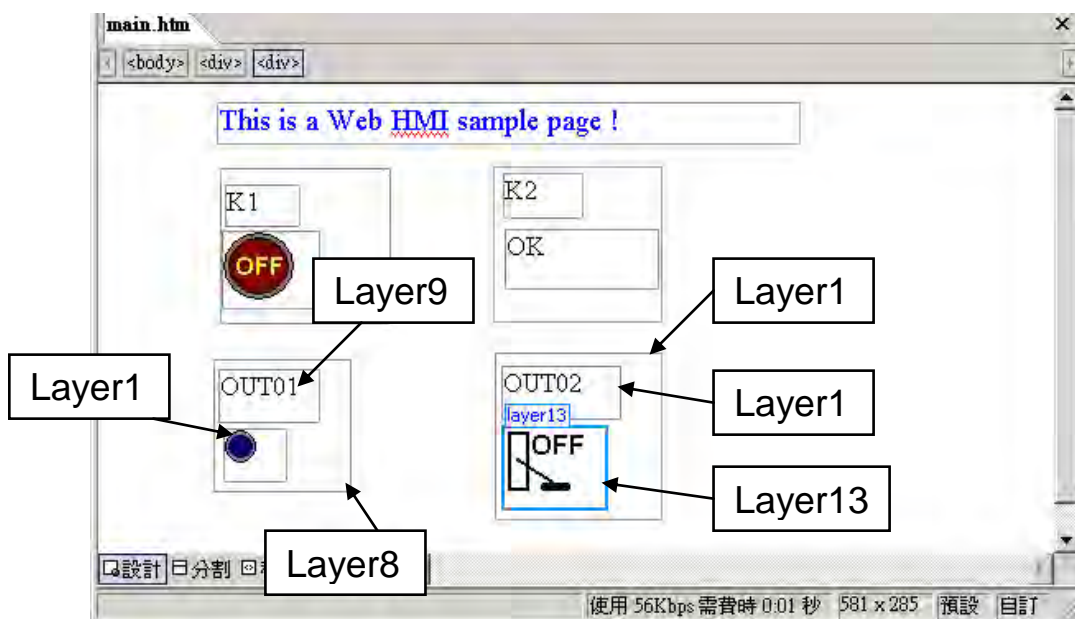

Now please insert one another “Layer14”. Inside the “Layer14” please insert one “Layer15” with a “T1 = xxx ms” symbol. And two empty Layers – “Layer16” & “Layer17” just below the “Layer15”. We will use T1 to display the Timer value “T1” in the ISaGRAF project.

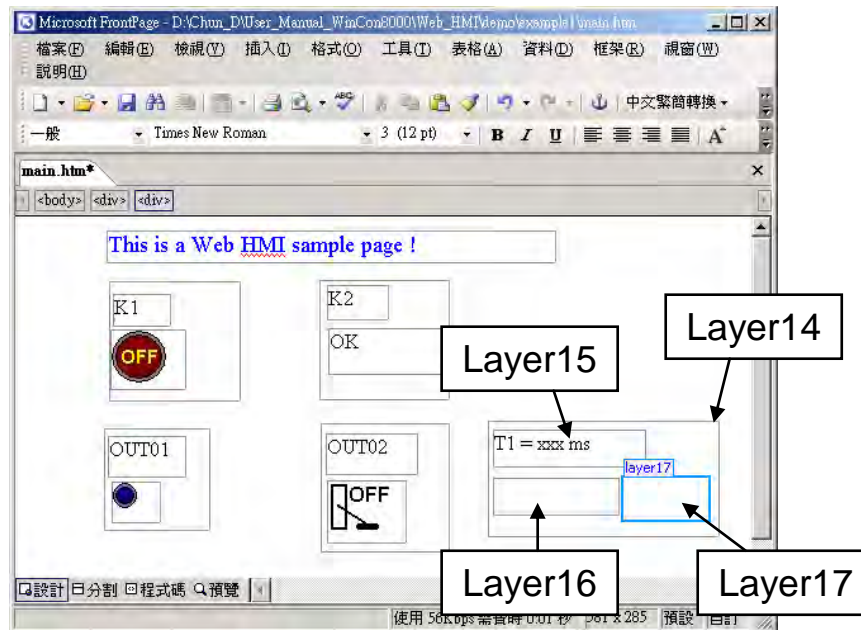

Click on “Save” to save this page.

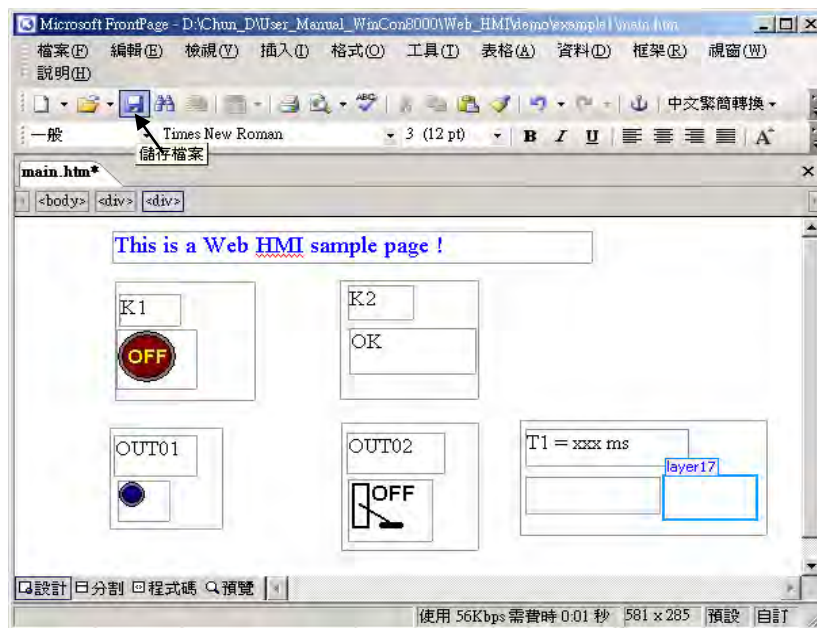

4.4.3 Step 3 – Adding Control Code To The Main.htm

Please switch the window to the source code. A valid HTML document will contain the basic objects as below.

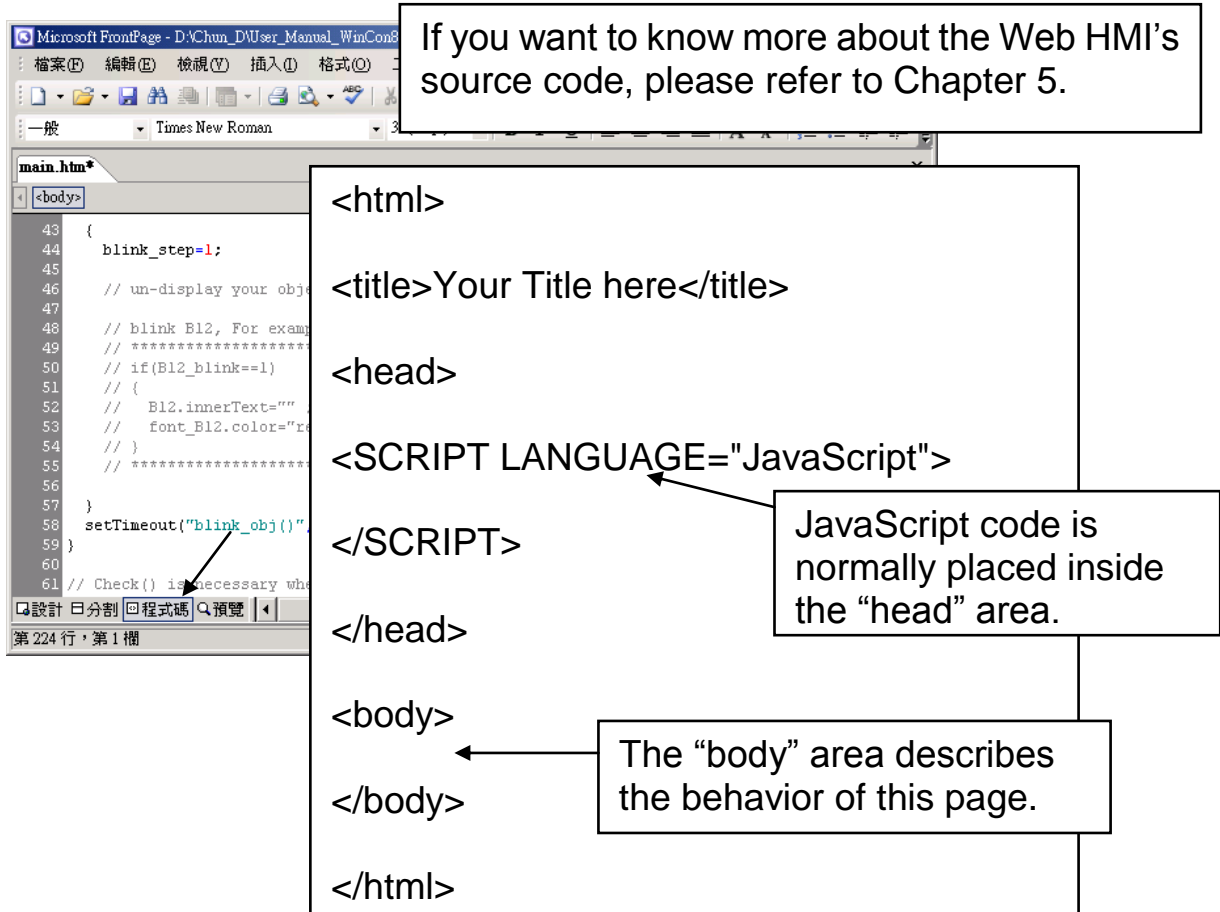

If you want to know more about the Web HMI's source code, please refer to Chapter 5.

```
<html>
<title>Your Title here</title>
<head>
<SCRIPT LANGUAGE="JavaScript">
</SCRIPT>
</head>
<body>
</body>
</html>
```

JavaScript code is normally placed inside the "head" area.

The "body" area describes the behavior of this page.

Please go to the <body> area and then modify the code as below.

Caption Area: Layer1
A Layer is starting with "<div " & ending with "</div>" tag

```
<!-- Caption -->
<font color="blue" size="4">
<div style="position: absolute; width: 353px; height: 24px; z-index: 1; left: 73px;
top: 12px" id="layer1">
This is a Web HMI sample page !
</div>
</font>
```

K1 Area: Layer2 to Layer4

```
<div style="position: absolute; width: 102px; height: 93px; z-index: 2; left: 75px; top: 52px" id="layer2">  
<div style="position: absolute; width: 44px; height: 24px; z-index: 1; left: 3px; top: 10px" id="layer3">  
K1</div>  
<div style="position: absolute; width: 58px; height: 46px; z-index: 2; left: 1px; top: 38px" id="layer4">  
</div>  
<p>&nbsp;</p></div>
```

Please insert name="B11" just after the "<img "

K2 Area: Layer5 to Layer7

```
<div style="position: absolute; width: 101px; height: 93px; z-index: 3; left: 241px; top: 51px" id="layer5">  
<div style="position: absolute; width: 47px; height: 26px; z-index: 1; left: 6px; top: 4px" id="layer6">  
K2</div>  
<div style="position: absolute; width: 92px; height: 35px; z-index: 2; left: 7px; top: 38px" id="layer7">
```

```
<font id="font_B12" color="blue" size="3">  
<b id="B12"> OK </b>  
</font> </div>
```

Please modify "OK <div>" to become

```
<font id="font_B12" color="blue" size="3">  
<b id="B12"> OK </b>  
</font> </div>
```

```
<p>&nbsp;</p></div>
```

OUT01 Area: Layer8 to Layer10

```
<div style="position: absolute; width: 82px; height: 79px; z-index: 4; left: 71px; top: 168px" id="layer8">  
<div style="position: absolute; width: 60px; height: 31px; z-index: 1; left: 3px; top: 6px" id="layer9">  
OUT01</div>  
<div style="position: absolute; width: 37px; height: 31px; z-index: 2; left: 6px; top: 42px" id="layer10">  
</div>  
<p>&nbsp;</p></div>
```

Please insert name="B1" just after the "<img "

OUT02 Area: Layer11 to Layer13

```
<div style="position: absolute; width:100px; height:100px; z-index: 5;
left:242px; top:164px" id="layer11">
<div style="position: absolute; width: 71px; height: 31px; z-index: 1; left: 4px;
top: 8px" id="layer12">
OUT02</div>
```

```
<div style="position: absolute; width: 61px; height: 48px; z-index: 2; left: 5px;
top: 45px" id="layer13">
</div>
```

```
<form name="form_B2" method="post" action="/main.dll">
  <input name="BEGIN" type="hidden">
  <input name="B2" type="hidden" value="0">
  <input name="END" type="hidden">
</form>
```

```
<p>&nbsp;</div>
```

Please insert

Style="cursor:hand" name="B2" onclick="ON_OFF(form_B2, form_B2.B2, boolean_val[2])" just after the "<img " tag

Please insert

```
<form name="form_B2" method="post"
action="/main.dll">
  <input name="BEGIN" type="hidden">
  <input name="B2" type="hidden" value="0">
  <input name="END" type="hidden">
</form>
```

T1 Area: Layer14 to Layer17

```
<div style="position: absolute; width: 181px; height: 90px; z-index: 6; left: 374px; top: 162px" id="layer14">
```

```
<div style="position: absolute; width: 119px; height: 28px; z-index: 1; left: 4px; top: 7px" id="layer15">
```

```
T1 = <b id="T1">xxx ms</b></div>
```

Please modify "T1 = xxx ms </div>" to become
T1 = <b id="T1">xxx ms</div>

```
<div style="position: absolute; width: 98px; height: 28px; z-index: 2; left: 4px; top: 45px" id="layer16">
```

```
<form name="form_L21" method="post" action="/main.dll">  
  <input name="BEGIN" type="hidden">  
  <input name="L21" type="text" size="8" value="xxx">  
  <input name="END" type="hidden">  
</form>
```

```
&nbsp;</div>
```

Please insert below code inside "Layer16"

```
<form name="form_L21" method="post" action="/main.dll">  
  <input name="BEGIN" type="hidden">  
  <input name="L21" type="text" size="8" value="xxx">  
  <input name="END" type="hidden">  
</form>
```

```
<div style="position: absolute; width: 67px; height: 33px; z-index: 3; left: 106px; top: 44px" id="layer17">
```

```
<input type="button" value="Enter" onclick="Check_L21( )">
```

```
&nbsp;</div>
```

```
<p>&nbsp;</div>
```

Inside the "Layser17", please insert
<input type="button" value="Enter" onclick="Check_L21()">

We have finished the code in the <body> </body> area.

Now please go to the "head" area.

In the "head" area, please modify the sample code to be as below.

// variable to record object's blink state, 0:not blink, 1: blink, For example:

// *****

var B12_blink=0; // init as 0:not blink

// *****

// function to blink object

var blink_step=0;

function blink_obj()

{

if(blink_step==1)

{

blink_step=0;

// display your object here

// blink B12. For example:

// *****

if(B12_blink==1)

{

B12.innerText="Error !" ;

font_B12.color="red";

}

// *****

}

else

{

blink_step=1;

// un-display your object here

// blink B12, For example:

// *****

if(B12_blink==1)

{

B12.innerText="" ;

font_B12.color="red";

}

// *****

}

setTimeout("blink_obj()", blink_period);

}

The "Error !" symbol will blink when the K2 = True in this example. Please un-mask the code inside these 3 areas.

We need a function "Check_L21 to check the entered T1 value and post it to the Wincon. Please un-mask the sample code to be as below.

```
// form sample, to check value of L21 & then post val to controller
```

```
// For example:
```

```
// *****
```

```
function Check_L21()
{
  var val=form_L21.L21.value;
  if(val>12000 || val<4000)
  {
    alert("T1's value should be in the range of 4000 to 12000");
    return;
  }
  Check(form_L21); // post value to the controller
}
```

```
// *****
```

And also inside the "refresh_data()" function, please insert below code.

```
// To refresh displayed data, this function is called by IE about every 1.5 sec later
```

```
function refresh_data()
{
  B1.src = "./img/circle_blue" + boolean_val[1] + ".jpg";
  B2.src = "./img/cmd" + boolean_val[2] + ".jpg";

  B11.src = "./img/big_Tcircle_red" + boolean_val[11] + ".jpg";

  if(boolean_val[12]==0)
  {
    B12.innerText="Ok";
    font_B12.color="blue";
    B12_blink=0;
  }
  else
  {
    B12_blink=1;
  }
  T1.innerText=timer_val[21] + " ms";
}
```

Now we have finished all the code. Please save it.

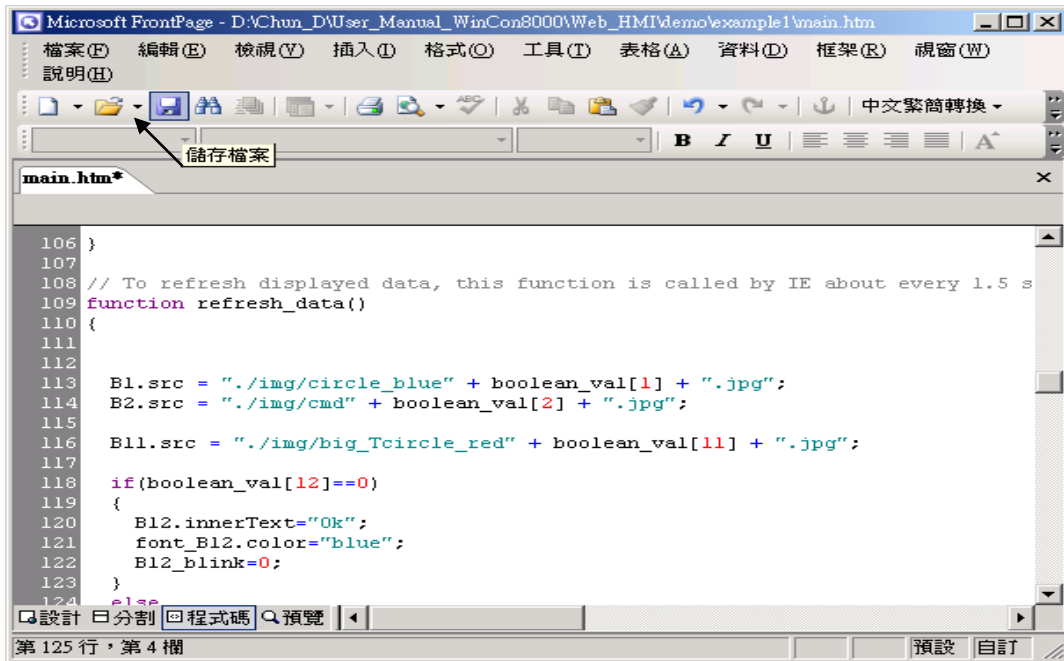

You may click on "Preview" to simulate its run time behavior.

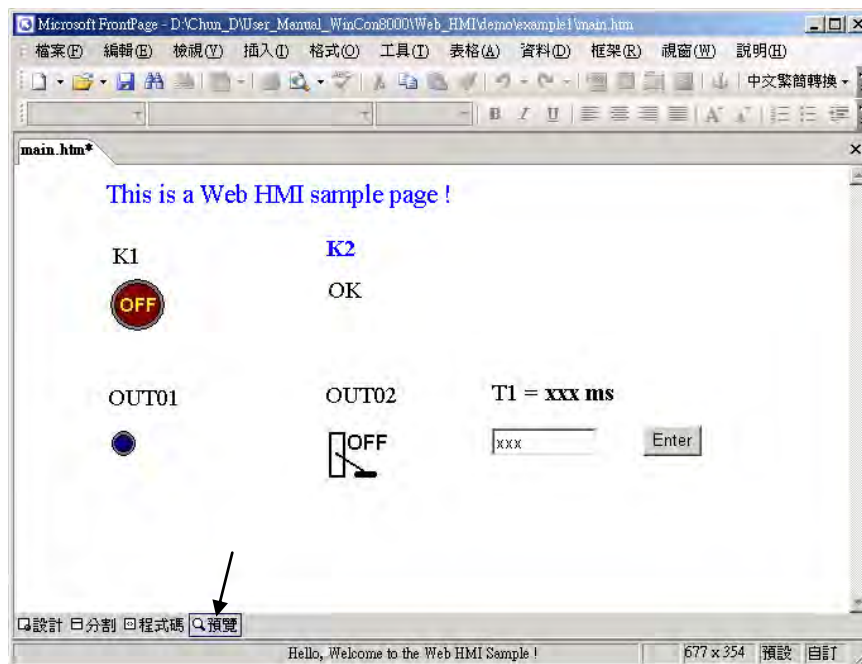

4.4.4 Step 4 – Download Web HMI Pages To The Controller

The steps are similar as listed in [Section 3.2](#). If you haven't practiced "Setting Up A Web HMI Demo" listed in the [Chapter 3](#), it's better to do it once to get familiar with it.

First set the web options

Run "isaXPce6.exe" of XPAC. In "Web" page, check on "Enable Web HMI" and then "Setting". Please check on "Enable Account Security" and then click on "Edit" to set (username , password). **Then remember to click on "OK"**.

Note: If "Enable Account Security" is not checked, any user can easily get access to your XP-8xx7-CE6 through the Internet Explorer.

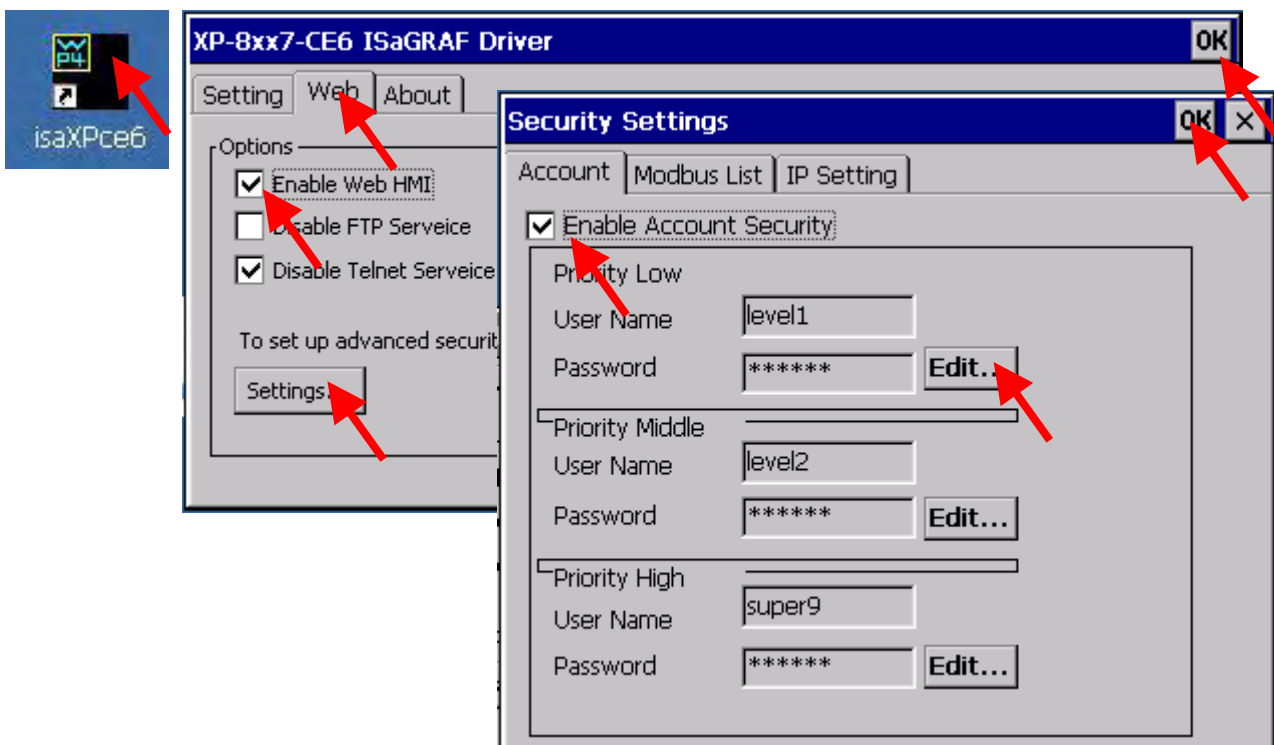

And then, please copy all files in this example1 to the controller

```
<your hard drive>:\example1\ *.*
```

to the XP-8xx7-CE6's

\SystemDisk\Temp\HTTP\WebHMI

Since the Web Pages are modified or new copied, please run "rs_wphmi.exe" to reset the Web server. **The "rs_wphmi.exe" must be run every time when**

user has modified any file in the XP-8xx7-CE6's \SystemDisk\Temp\HTTP\WebHMI\

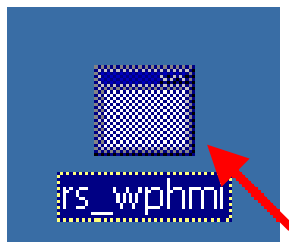

Show Time:

Please run Internet Explorer (Rev. 6.0 or later) on PC, key in the IP address of your XPAC. For example: 61.218.42.10 or http://61.218.42.10

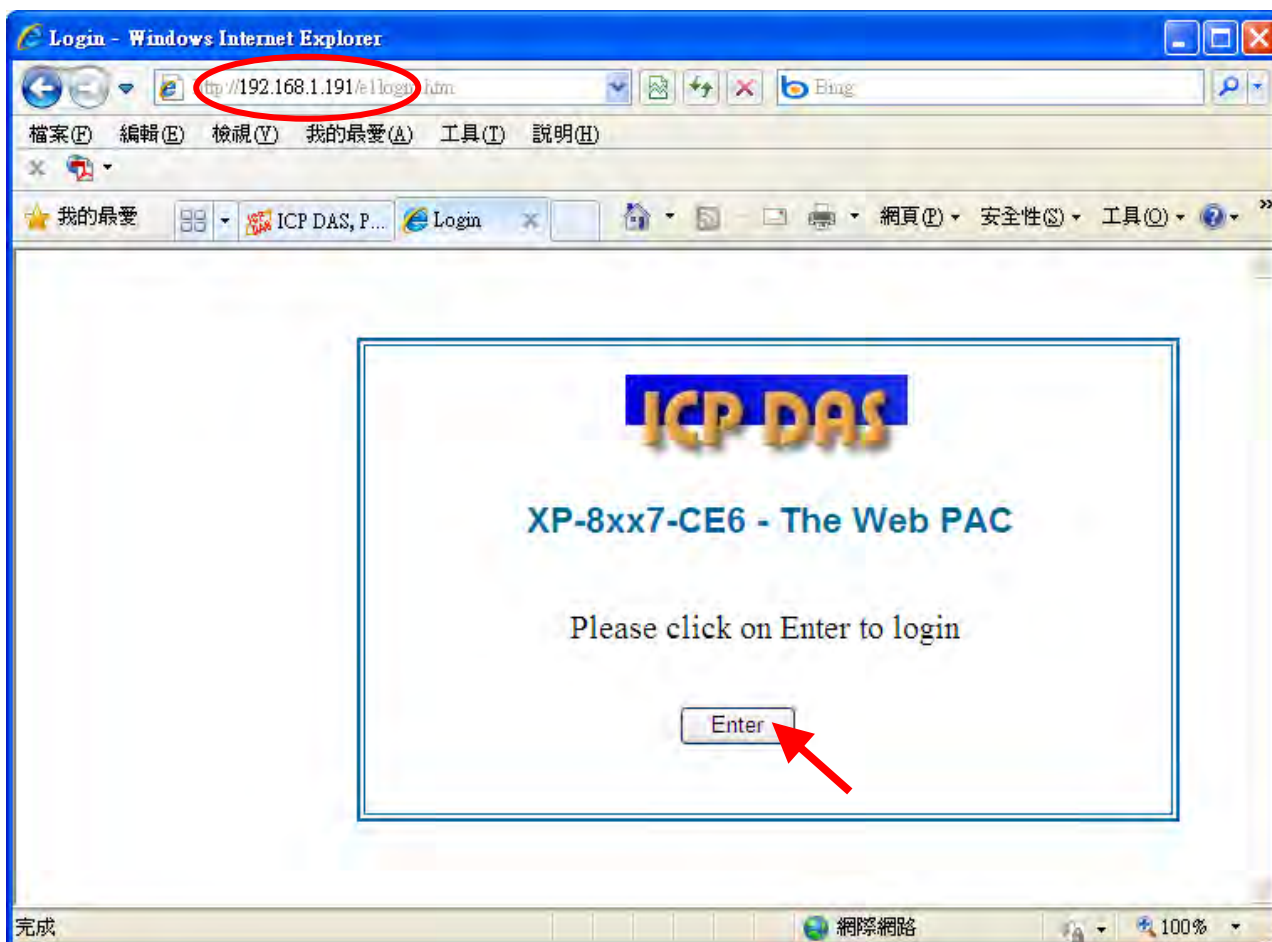

If there is something wrong with the web page. You may enable the below item to display the debug message every time it has error.

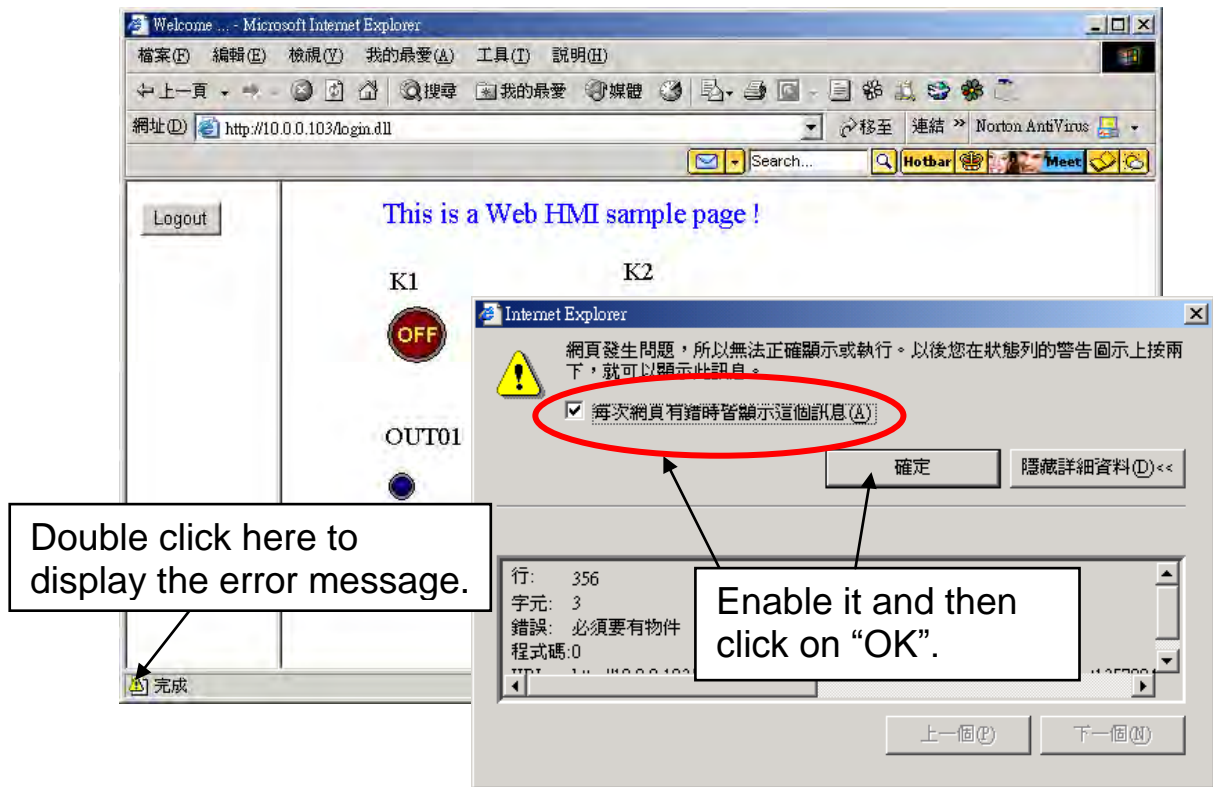

And also check if your ISaGRAF project already downloaded to the controller ([Section 4.3](#) or [section 3.2.3](#)). And do you assign the correct Modbus Network address to the respective ISaGRAF variables? ([Section 4.1.5](#)).

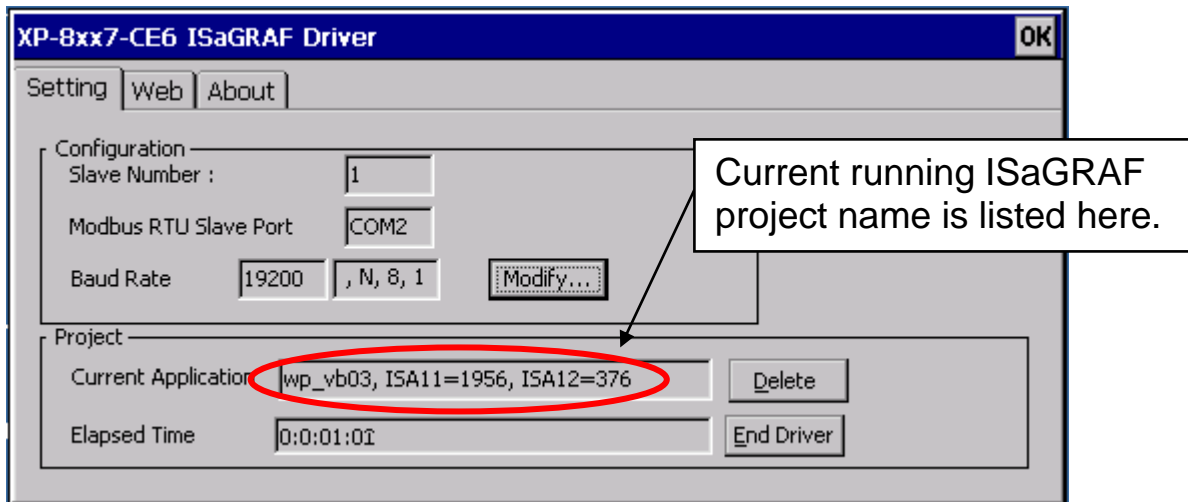

Chapter 5 Web HMI Basics

The XP-8xx7-CE6 is the abbreviation of the XP-8047-CE6/8347-CE6/8747-CE6.
The XP-8xx6-CE6 is the abbreviation of the XP-8046-CE6/8346-CE6/8746-CE6.

Important Notice

1. **XP-8xx7-CE6/8xx6-CE6 supports only the High profile I-8K and I-87K I/O cards in its slot 1 to 7. Please refer to XP-8xx7-CE6 CD: [\naptos\isagraf\xp-8xx7-ce6\english-manu](#) for Data sheet.**
2. Please always set a fixed IP address to the XP-8xx7-CE6. (**No DHCP**)

Note:

1. This chapter describes the programming basics for the Web HMI. We will not focus on the HTML basics. If you want to know more about the HTML programming, the best way is to “buy a HTML related book” from the bookstore. There are a lot of books doing this job.
2. The Web HMI only supports the basic HTML tags. It doesn't support ASP, PHP or JSP or other Page Server language.
3. Please do not use `<frameset>` `</frameset>` , `<frame>` `</frame>` in the Web HMI.
4. Note: The object name, object ID, code, variable name and function name is case sensitive. For example, `refresh_data()` and `Refresh_data()` is different.
5. There are more than ten Web HMI examples in the XP-8xx7-CE6's CD-ROM. Please refer to [section 3.1](#).

5.1 Basic Files For The Web HMI

The basic Web HMI files include 2 folders and 3 DLL files and 4 htm files as below.

`./img/` (default image files - *.jpg , *.bmp , *.gif)
`./msg/` (default message files – wincon.js & xxerror.htm)

whmi_filter.dll (three DLL files)

login.dll

main.dll

index.htm (first default page)

login.htm (the Web HMI welcome page)

menu.htm (the page-menu page, normally on the left on the Internet Explorer)

main.htm (first page when successfully login)

User may put his own image files into the folder named as “user_img”. And put user-defined javascript file or css file into the folder named as “user_msg”. Other folder name is not acceptable by the Wincon Web HMI.

The “index.htm” file is the default entry page of the web server. User must not modify it. The “index.htm” re-directs to the “login.htm” file in 1 to 2 seconds when someone visits the XP-8xx7-CE6 via the Internet Explorer.

User may modify the “login.htm”, “menu.htm” and “main.htm” to fit the requirement.

5.2 Login.htm

Login.htm is the first welcome page when a user visiting in. It can be modified. Below is the basic code for the login.htm

```
<html>
<head>
<title>Login</title>
<meta http-equiv=pragma content=no-cache>
<meta http-equiv="Content-Type" content="text/html; charset=UTF-8" >
<script language="JavaScript">
var random_val=123;
function get_random_val()
{
  var rightNow = new Date();
  random_val += 323456789*rightNow.getMinutes()
    + 107654321*(rightNow.getTime()%1000);
  setTimeout("get_random_val()", 197); // repeat call
}

//check if username and password are empty
function validate(fm)
{
  setKey(fm);
  return true;
}

//Embed key while submitting
function setKey(fm)
{
  var rightNow = new Date();
  cookieVal = random_val+rightNow.getTime();
  fm.key_.value = cookieVal;
}
```

This line is only for the “Login.htm”, please do not apply to other pages, for example, the “menu.htm” & “main.htm” & other .htm pages.

Please apply your charset here.
For example,
English: UTF-8
Traditional Chinese: big5
Simplified Chinese: gb2312
or other language

```
</script>
</head>
```

get_random_val() should be always called at the beginning of the Login.htm . It is the entry point of the Login.htm

```
<body onload="get_random_val()">
```

```
<div style="position: absolute; width: 332px; height: 34px; z-index: 5; left: 147px; top: 27px" id="layer1">
Welcome !</div>
```

Your caption is here.

```
<div style="position:absolute; width:122px; height:38px; z-index:4; left: 171px; top: 95px;" id="layer2">
```

"form1" is necessary

```
<form name="form1" action="./login.dll" method="post">
  <input type="hidden" name="key_">
  <input type="submit" name="Submit" value=" Enter " style="cursor:hand"
onClick="return validate(this.form)">
</form>
```

You may modify " Enter " to your own word. For example "請進" .This may require user to modify the related "charset" at the beginning of this page.

```
</div>
```

```
</body>
```

```
<!-- To ensure no-cache work -->
<head>
<meta http-equiv=pragma content=no-cache>
</head>
```

```
</html>
```

This code is only for the "Login.htm" , please do not apply to other pages, for example, the "menu.htm" & "main.htm" & other .htm pages.

That's all the login.htm need. You can insert more images or text to it. Only remember to keep its basic code.

5.3 Menu.htm

Note:

If you want to know more about the multi-page application, there are two demos in the XP-8xx7-CE6 CD-ROM:

[\napdos\isagraf\xp-8xx7-ce6\xpce6-webhmi-demo\xphmi_05 & xphmi_05a](http://napdos\isagraf\xp-8xx7-ce6\xpce6-webhmi-demo\xphmi_05 & xphmi_05a) .

The “xphmi_05” place its page-menu on the left, while “xphmi_05a” on the top.

The “Menu.htm” defines the Page-menu of the Web HMI especially for the multi-page application. The page-menu can place only on the left or on the top.

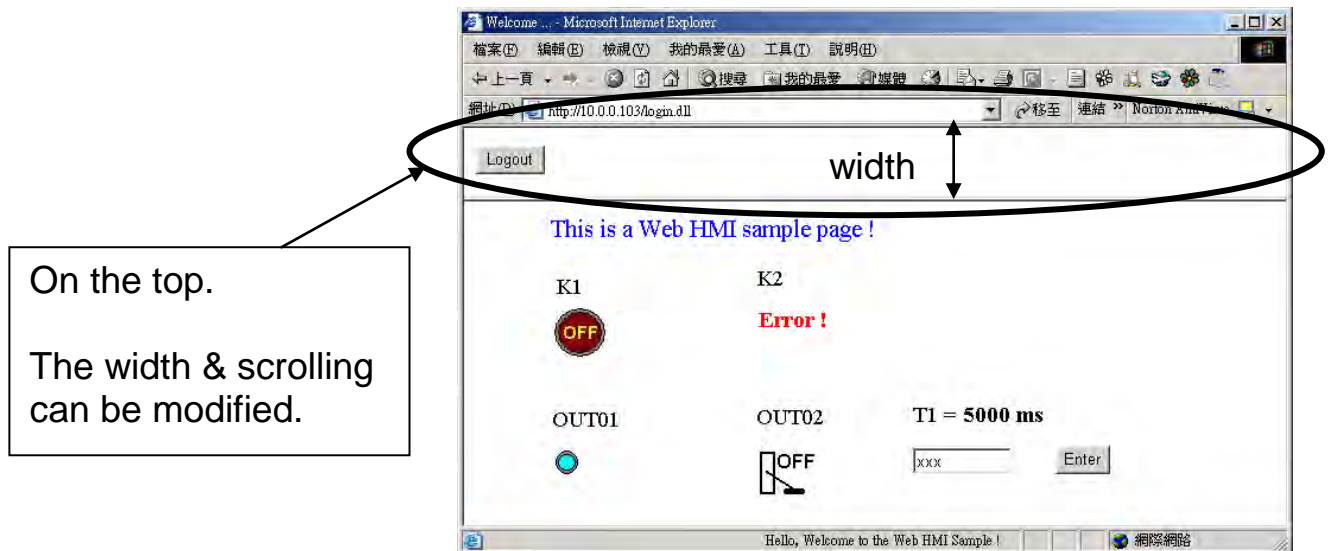
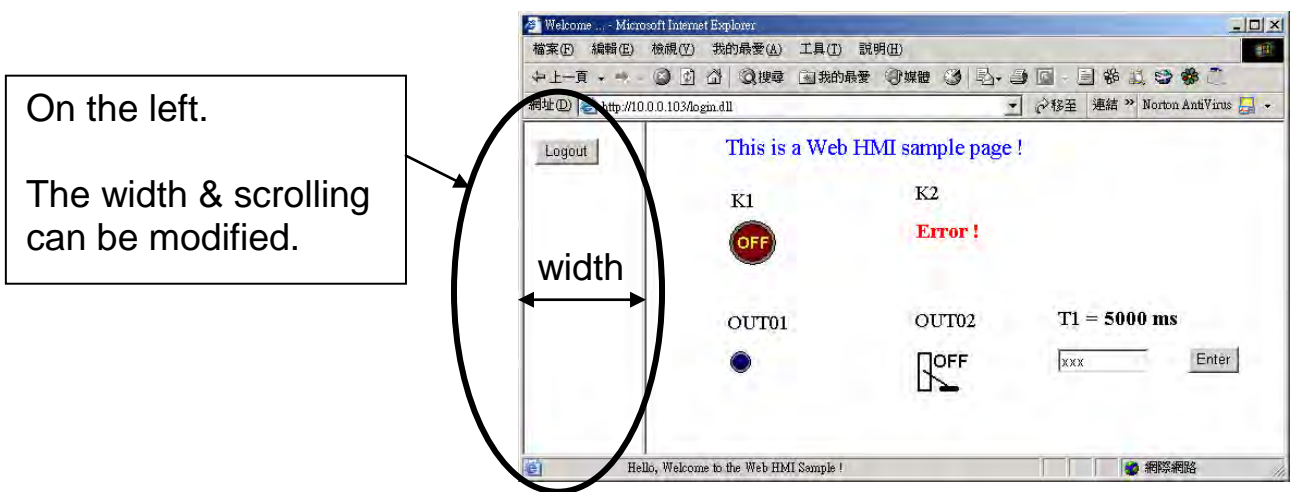

Below is the basic code for the menu.htm

```
<!-- top_or_left=1 , scrolling=0 , width=60 , resize=1 -->
```

The first row is not a comment, it defines the Page-Menu behavior

top_or_left:	1:Top , 0:Left
scrolling:	1:Yes , 0:No
width:	width of the Menu Frame, 0 – 999 (unit is pixel)
resize:	1:Yes , 0:No

```
<html>  
<head>  
<title>Title1</title>
```

```
<meta http-equiv="Content-Type" content="text/html; charset=UTF-8" >
```

```
<SCRIPT LANGUAGE="JavaScript" src="./msg/wincon.js"></SCRIPT>
```

```
<SCRIPT LANGUAGE="JavaScript">
```

```
function start1()  
{
```

```
  A_11();  
}
```

```
function refresh_data()  
{
```

```
  if(run_at_pc==1) return;  
}
```

```
</SCRIPT>
```

```
</head>
```

```
<body onload="start1()">
```

start1() is the entry point of the menu.htm

```
<!-- Logout button -->
```

```
<form name="form_logout" method="post" action="./login.dll">
```

```
  <input style="cursor:hand" name="CMD" type="submit" value="Logout"  
  onClick="return logout(this.form)">
```

```
</form>
```

form_logout is for the logout button.

```
</body>
```

```
</html>
```

Note:

If you want to know more about the multi-page application, there are two demos in the XP-8xx7-CE6 CD-ROM:

[\napdos\isagraf\xp-8xx7-ce6\xpce6-webhmi-demo\xphmi_05 & xphmi_05a .](#)

The "xphmi_05" place its page-menu on the left, while "xphmi_05a" on the top.

5.4 Main.htm

5.4.1 A Simple Main.htm Example

Before going further in the main.htm, first take a look at a simple main.htm example. This example only display a “Hello !” message when successfully login, nothing else.

```
<html>
<head>
<title>Title1</title>
<meta http-equiv="Content-Type" content="text/html; charset=UTF-8" >
```

Please apply your charset here. For example, English: UTF-8, Simplified Chinese: gb2312, Traditional Chinese: big5 , or other language.

```
<SCRIPT LANGUAGE="JavaScript" src="./msg/wincon.js"></SCRIPT>
```

This line is necessary for menu.htm , main.htm & other multi-pages

```
<SCRIPT LANGUAGE="JavaScript">
show_scroll_word(200,"Hello, Welcome to the Web HMI Sample !");
```

```
function refresh_data()
{
}
```

Calling show_scroll_world() will display a moving word at the bottom of the Internet Explorer. Here 200 means 200 ms. You may make it slower, for example. using 500.

```
</SCRIPT>
</head>
```

refresh_data() is called when the Internet Explorer has received the requested data from the controller. It is called in the period about 1.25 to 5 seconds depends on the communication quality.

```
<body onLoad="init()">
```

init() is the entry pint of the main.htm & other multi-pages.

```
<font color="blue" size="4">
```

```
<div style="position: absolute; width: 353px; height: 24px; z-index: 1; left: 73px; top: 12px" id="layer1"> Hello !</div>
</font>
```

A layout object is starting with “<div” & ending at “</div>” tags.
Here only show a message “Hello !”

```
</body>
</html>
```

You may replace the main.htm in the XP-8xx7-CE6 CD-ROM:
[\napdos\isagraf\xp-8xx7-ce6\xpce6-webhmi-demo\sample](#)
 to the above main.htm & download it to the controller (refer to [section 4.4.4](#)).
 You will see the below window when you login successfully.



User may try to plug out the Ethernet cable of the XPAC or of your PC. You will see it show “Communication is temporary break now !” in about 10 seconds. When you plug the cable back, the communication will be recovered in about 10 to 45 seconds.

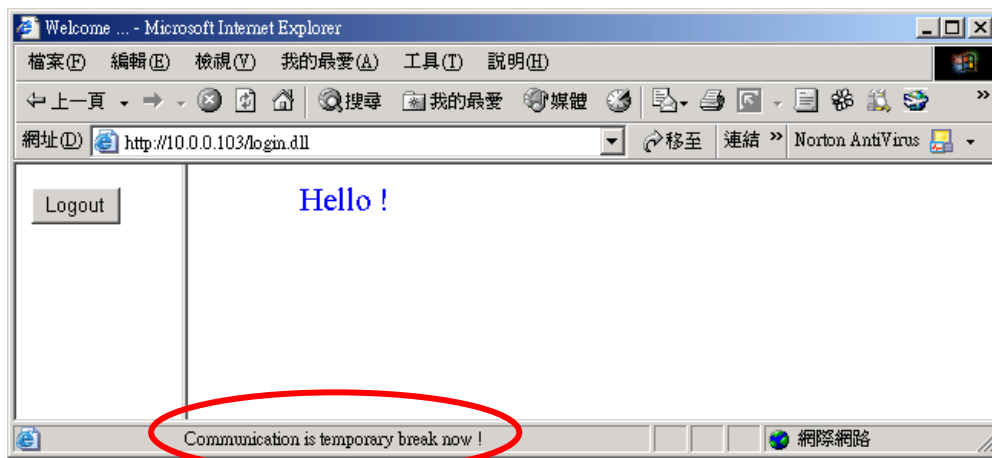

If the communication broken time exceeds 120 seconds, it will show the below message. You have to close the Internet Explorer & open it again to re-login.



5.4.2 More About The refresh_data() Function And Dynamic Data

Note:

The code, variable name and function name is case sensitive. For example, refresh_data() is correct, however Refresh_data() is not correct.

The refresh_data() function must always apply in the main.htm and other multi-pages. It is called when the Internet Explorer has received the requested data from the controller. The calling period is about 1.25 to 5 seconds depends on the communication quality

The refresh_data() is often used for refreshing the dynamic data. For example, the boolean value , integer value, timer value or float value of the variables in the ISaGRAF project.

The Internet Explorer can access to the data in the ISaGRAF project only when they are assigned a unique Modbus Network Address No (refer to [section 4.1.5](#)). The Web HMI only accepts Network Address No in the range of 1 to 1024. The data without a Network Address No (No. = 0) or not in the range of (1 to 1024) is not accessible by the Internet Explorer.

The main.htm and other multi-pages can use the below variable array to access to the ISaGRAF's data (case sensitive). The identifier appeared in the [] is the related Network Address No. For example boolean_val[2] means the boolean value of the ISaGRAF boolean data which is assigned with the Network Address No. = 2.

boolean_val	boolean value in the ISaGRAF
word_val	word value in the ISaGRAF, -32768 to +32767
float_val	real value in the ISaGRAF, for ex, 1.234 , -0.456E-02
timer_val	timer value in the ISaGRAF, unit is ms, max = 86399999 (< 1 day)
string_val	message value in the ISaGRAF, max string length is 255

To access to long integer value (32-bit integer) please use get_long_val() function. For example, get_long_val(11) , get_long_val(13) , get_long_val(15).

get_long_val()	long integer value in the ISaGRAF, -2147483648 to +2147483647
-----------------	--

Note:

The long integer, timer and float variable's Network Address No. must occupy 2 No. in the ISaGRAF project (refer to section 4.2 of "User's Manual of ISaGRAF Embedded Controllers" or in the CD-ROM:

[\napdos\isagraf\xp-8xx7-ce6\english-manu\ " User_Manual_I_8xx7.pdf"](#)).

That means if you assign a Network Address No.= 11 to a Real type variable(or Timer or integer will have 32-bit value – larger than 32767 or smaller than -32768), the next No. 12 should not assigned to any other variable in the ISaGRAF project. However you may assign No.=13 to one another variable.

5.4.2.1 Displaying Dynamic Boolean Data

Demo example: xphmi_02 and xphmi_05 ([section 3.1](#))

Let's look back to the refresh_data function. If user want to display the dynamic boolean value, the below code can be used.

```
...
function refresh_data()
{
  B1.src = "./img/circle_blue" + boolean_val[1] + ".jpg" ;
}
...
<body onLoad="init()">
...
<div style="position: absolute; width: 214px; height: 53px; z-index: 2; left: 102px;
top: 79px">
</div>
...
</body>
```

The action of the image object "B1" is defined here.

if boolean_val[1]=1, it display image "B1" as "img/circle_blue1.jpg"
if boolean_val[1]=0, it display image "B1" as "img/circle_blue0.jpg"

The layout (or location) of the image object "B1" is defined here by the "<div" and "</div>" tags.

The declaration of image "B1" is defined here by the "img" tag & name="B1" src= ... ← "src=" defines the initial value of B1

5.4.2.2 Displaying Dynamic Float & Word & Timer Data

Demo example: xphmi_01 , xphmi_03 and xphmi_05 ([section 3.1](#))

If user want to display the dynamic float value, the below code can be used.

```
...
function refresh_data()
{
  F21.innerText = float_val[21];
}
...
```

The action of the Text object "F21" is defined here.

```
<body onLoad="init()">
...
```

If want to display Word data, please use "word_val[]"
If want to display Timer data, please use "timer_val[]".
For ex, F21.innerText = timer_val[21] + " ms";

The layout (or location) of the Text object "F21" is defined here by the "<div" "</div>" tags.

```
<div style="position: absolute; width: 214px; height: 53px; z-index: 2; left: 102px; top: 79px">
<b id="F21"> xxxx </b> </div>
...
</body>
```

The declaration of Text object "F21" is defined here by the "<b" tag & id="F21" & "" tag initial value of this F21 is "xxxx"

5.4.2.3 Displaying Dynamic Long Integer Data

Demo example: xphmi_03 and xphmi_05 ([section 3.1](#))

If user want to display the dynamic long integer value (32-bit format), the below code can be used.

```
function refresh_data()
{
  L11.innerText = get_long_val(11);
}
...
```

The action of the Text object "L11" is defined here.

```
<body onLoad="init()">
...
```

The layout (or location) of the Text object "L11" is defined here by the "<div" and "</div>" tags.

```
<div style="position: absolute; width: 214px; height: 53px; z-index: 2; left: 102px; top: 79px">
<b id="L11"> xxx </b> </div>
...
</body>
```

The declaration of Text object "L11" is defined here by the "<b" tag and id="L21" and "" tag , the initial value of this L11 is "xxx".

5.4.2.4 Displaying Dynamic String Data

If user want to display the dynamic string value (max length is 255), the below code can be used.

```
...
function refresh_data()
{
  S31.innerText = string_val[31];
}
...
<body onLoad="init()">
...
<div style="position: absolute; width: 214px; height: 53px; z-index: 2; left: 102px;
top: 79px">
<b id="S31"> empty </b> </div>
...
</body>
```

The action of the Text object "S31" is defined here.

The layout (or location) of the Text object "S31" is defined here by the "<div" and "</div>" tags.

The declaration of Text object "S31" is defined here by the "<b" tag and id="S31" and "" tag, the initial value of this S31 is "empty".

5.4.2.5 Trigger A Boolean Object To Blink

Demo example: xphmi_02 and xphmi_05 ([section 3.1](#))

Some application may need a message to blink when the boolean value changes.

For example, If boolean_val[12] is False, it means "OK". However if boolean_val[12] is True, it means "Error !". User may want to make this "Error !" blink to attract viewer's attention.

The below code can do this job.

```
...
var blink_period=500;
setTimeout("blink_obj()", blink_period);
var B12_blink=0; // init as 0:not blink
var blink_step=0;
```

The blinking period, unit is ms

Setup a timer to handle the blinking action

1: to blink , 0: no blink

```

function blink_obj()
{
  if(blink_step==1)
  {
    blink_step=0;
    if(B12_blink==1)
    {
      B12.innerText="Error !" ;
      font_B12.color="red";
    }
  }
  else
  {
    blink_step=1;
    if(B12_blink==1)
    {
      B12.innerText="" ;
      font_B12.color="red";
    }
  }
  setTimeout("blink_obj()", blink_period);
}

```

Blink step 1:
To display "Error !" in red color.

Blink step 2:
To display "" (nothing) in red color.

```

...function refresh_data()
{
  if(boolean_val[12]==0)
  {
    B12.innerText="Ok";
    font_B12.color="blue";
    B12_blink=0;
  }
  else
  {
    B12_blink=1;
  }
}
...

```

The action of the Text object "B12" is defined here.
If boolean_val[12]=0, no blink.
If boolean_val[12]=1, blink.

The layout (or location) of the Text object "B12" is defined here by the "<div" and "</div>" tags.

```

<body onLoad="init()">
...

<div style="position: absolute; width: 214px; height: 53px; z-index: 2; left: 102px;
top: 79px">

<font id="font_B12" color="blue" size="3">
<b id="B12">OK</b>
</font>
</div>
...
</body>

```

The "" & "" tags can be used for controlling the font's color and font's size.

The declaration of Text object "B12" is defined here by the "<b" tag and id="B12" and "" tag, the initial value of this B2 is "OK"

5.4.2.6 Displaying Float Value With Fixed Digit Number Behind The "." Symbol

Demo example: xphmi_06 and xphmi_07 ([section 3.1](#))

The float_str1(para1 , para2) function can convert float value to a string with fixed digit number behind the dot "." symbol

para1 is the float value to be converted, for ex, 1.234567
para2 is the digit number behind the "." dot symbol, 0 to 6
for ex, float_str1(1.234567, 3) return "1.234",
float_str1(1.234567, 2) return "1.23"

```

...
function refresh_data()
{
  F21.innerText = float_str1( float_val[21] , 3) ;
}

```

Convert float val at Network Address 21 to a string with digit number = 3 behind the "." dot symbol.

5.4.3 Post Data To The Controller

The former [section 5.4.2](#) listing how to get and display data from the controller. This section focuses on posting data to the controller, in other word to control the XPAC via the Internet Explorer.

To set a new value to the boolean, word, long integer, float, timer and string variables in the ISaGRAF project, we need “form” object appeared in the main.htm or other multi-pages. A “form” object looks like as below.

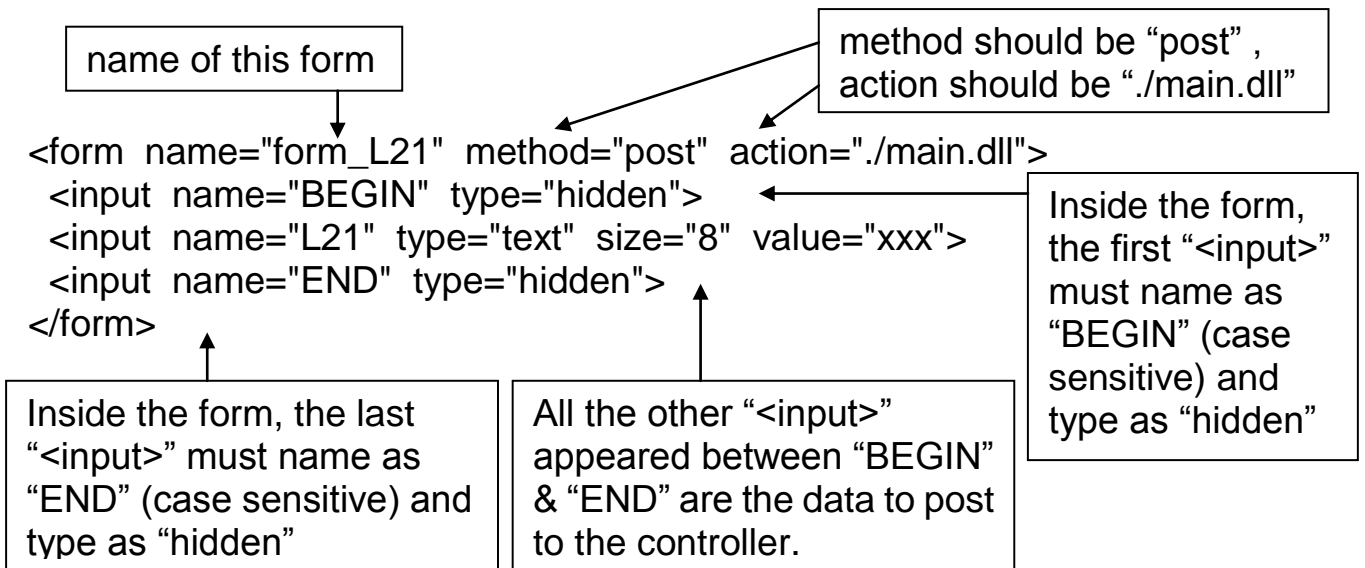

The “<input>” name to control the WinPAC’s data must follow below format. The number followed behind the first letter should be in the range from 1 to 1024. This number is point to the variable name in the ISaGRAF project with the same Modbus Network Address No.

B	point to the ISaGRAF boolean data , for ex, B5 , B109
W	point to the ISaGRAF word data (-32768 to +32767), for ex, W9 , W1001
L	point to the ISaGRAF long integer data (-2147483648 to +2147483647), for ex, L21. This “L” Also point to the ISaGRAF timer data
F	point to the ISaGRAF real data, for ex, F13 , F235
S	point to the ISaGRAF message data , for ex, S18

Note:

The long integer, timer and float variable’s Network Address No. must occupy 2 No. in the ISaGRAF project. (refer to section 4.2 of “User’s

Manual of ISaGRAF Embedded Controllers” or in the CD-ROM:

[\napdos\isagraf\xp-8xx7-ce6\english-manu\ ” User_Manual_I_8xx7.pdf”](#))

That means if you assign a Network Address No.= 11 to a Real type variable(or Timer or integer will have 32-bit value – larger than 32767 or smaller than -32768), the next No. 12 should not assigned to any other variable in the ISaGRAF project. However you may assign No.=13 to one another variable.

5.4.3.1 Post Boolean Value to The Controller

A. To post by the image

...

ON_OFF function is used for posting Boolean value to the controller by refer to the current Boolean value.

```
function ON_OFF(form_obj, obj, current_boo_value)
```

```
{  
  if(current_boo_value==0)  
  {  
    flag = confirm("turn ON ?");  
    if(flag) obj.value=1;  
  }  
  else  
  {  
    flag = confirm("turn OFF ?");  
    if(flag) obj.value=0;  
  }  
  if(flag)  
  {  
    if(GetUserID(form_obj)==true) form_obj.submit();  
  }  
}
```

The first parameter is the name of the "form".
The second parameter is the "<input>" name inside the form.

Demo example: xphmi_02 and xphmi_05

```
function refresh_data()
```

```
{  
  B2.src = "img/cmd" + boolean_val[2] + ".jpg" ;  
}
```

Display the current boolean image. In this example,

...

```
<body onLoad="init()">
```

...

```
<div style="position: absolute; width:100px;height:100px; z-index: 5; left: 242px;  
top: 164px" >
```

The layout (or location) of the image object "B2" is defined here by the "<div" and "</div>" tags.

"cursor:hand" will display the mouse arrow as a hand when entering the image area

```

```

Name of the image object

The onclick will call ON_OFF() when the mouse click on it.
The first parameter is the name of the "form". Here is "form_B2".
The second parameter is the "<input>" name inside the form. Here is "form_B2.B2".
The last is the current Boolean value. Here is boolean_val[2].

```

<form name="form_B2" method="post" action="/main.dll">
  <input name="BEGIN" type="hidden">
  <input name="B2" type="hidden" value="0">
  <input name="END" type="hidden">
</form>
</div>
...
</body>

```

Name of the form

Name of "<input>" inside the form. Here is "B2". Because it is inside "form_B2", then we must use the name of "form_B2.B2" to identify it.

B. To post by buttons

```

function ON_(form_obj, obj)
{
  flag = confirm("turn ON ?");
  if(flag)
  {
    obj.value=1;
    if(GetUserID(form_obj)==true) form_obj.submit();
  }
}

```

Demo example: xphmi_02 and xphmi_05

ON_ function is used for posting boolean value as "True" to the controller .

```

function OFF_(form_obj, obj)
{
  flag = confirm("turn OFF ?");
  if(flag)
  {
    obj.value=0;
    if(GetUserID(form_obj)==true) form_obj.submit();
  }
}

```

OFF_ function is used for posting boolean value as "False" to the controller .

```

function refresh_data()
{
  B2.src = "img/big_Tcircle_red" + boolean_val[2] + ".jpg" ;
}
...

```

Display the current Boolean image. In this EX, 0: "img/big_Tcircle_red0.jpg" , 1: "img/ big_Tcircle_red1.jpg"

```

<body onLoad="init()">
...

```

The layout (or location) of the image object "B2" is defined here by the "<div" and "</div>" tags.

```

<div style="position: absolute; width: 56px; height:40px; z-index: 5; left: 82px; top: 69px" >

</div>
<div style="position:absolute; left:85px; top:124px; width:42px; height:27px;">

```



```
<input type="button" value="ON" style="cursor:hand" onClick="ON_(form_B2, form_B2.B2)">
```

A button to call ON_()
First parameter is the name of the form. Here is "form_B2"
The second is the name of the "<input>" inside the form.
Here is "form_B2.B2"

```
<form name="form_B2" method="post" action="/main.dll">  
  <input name="BEGIN" type="hidden" value="">  
  <input name="B2" type="hidden" value="1">  
  <input name="END" type="hidden" value="">  
</form>  
</div>
```

Name of "<input>" inside the form. Here is "B2". Because it is inside "form_B2", then must use the name of "form_B2.B2" to identify it.

```
<div style="position:absolute; left:85px; top:166px; width:47px; height:31px">  
<input type="button" value="OFF" style="cursor:hand" onClick="OFF_(form_B2, form_B2.B2)">  
</div>  
...  
</body>
```

A button to call OFF_()
First parameter is the name of the form. Here is "form_B2".
The second is the name of the "<input>" inside the form. Here is "form_B2.B2"

5.4.3.2 Post Word & Long & Float & Timer & String Value to The Controller

...

```
function Check(form_obj)  
{  
  flag = confirm("Are you sure?");  
  if(flag)  
  {  
    if(GetUserID(form_obj)==false) { return false; }  
    form_obj.submit();  
    return true;  
  }  
  else  
  {  
    return false;  
  }  
}
```

Check() is used for posting any "form".

Demo example:
xphmi_03, xphmi_04,
xphmi_05, xphmi_06
and xphmi_07

```
function refresh_data()
{
  L15.innerText=get_long_val(15);
  F17.innerText=float_val[17];
}
...

```

Display dynamic value here.
 If data is word , please use word_val[]
 If data is timer, please use timer_val[]
 If data is string, please use string_val[]

```
<body onLoad="init()">
...

```

The layout (or location) of the text object "L15" & "F17" are defined here by the "<div" "</div>" tags.

```
<div style="position: absolute; width: 195px; height: 25px; z-index: 2; left: 45px; top: 52px" >
L15 = <b id="L15">xxxx</b></div>
<div style="position: absolute; width: 196px; height: 29px; z-index: 3; left: 45px; top: 82px" >
F17 = <b id="F17">xxxx</b></div>

```

```
<div style="position:absolute; left:47px; top:131px; width:204px; height:60px">

```

```
<form name="form1" method="post" action="/main.dll">
  <input name="BEGIN" type="hidden" value="">
  <input name="L15" type="text" value="Enter long val (L15)">
  <input name="F17" type="text" value="Enter float val (F17)">
  <input name="END" type="hidden" value="">
</form>
</div>

```

Text input L15 & F17 inside the "form1".
 If data is timer, please use "L"; And "W" for word; "S" for string.

```
<div style="position:absolute; width:74px; height:31px; left: 234px; top: 150px;">
  <input type="button" style="cursor:hand" onClick="return Check(form1)" value="Enter">
</div>
...
</body>

```

"cursor:hand" will display the mouse arrow as a hand when entering the button area

When mouse click on this button, it calls Check() to post to the controller

5.5 Multi-Pages

The Web HMI in the XP-8xx7-CE6 supports multi-pages application. You may refer to [Chapter 3](#) to setup the multi-page demo – “xphmi_05” to see how it works.

5.5.1 Level 2 And Level 3 Page

The multi-page name can be any valid html file name. For example, “page2.htm”, “kitchen.htm”, “u2-page4.htm” .

If “u2-” appear in front of the page name, the page will become a Level 2 page. For example, the “u2-Page4.htm” in the “xphmi_05” demo.

If “u3-” appear in front of the page name, the page will become a Level 3 page. For example, the “u3-time.htm” in the “xphmi_05” demo.

What is a Level2 page? Only users login with the Middle or High priority can get access to it. To access to the Level3 page, users have to login as a High priority user. The page name without “u2-” and “u3-” is identified as Level 1 page. That means any user successfully login can access to it. For example: the “main.htm”.

The other rules for multi-pages are almost the same as “main.htm” ([section 5.4](#))

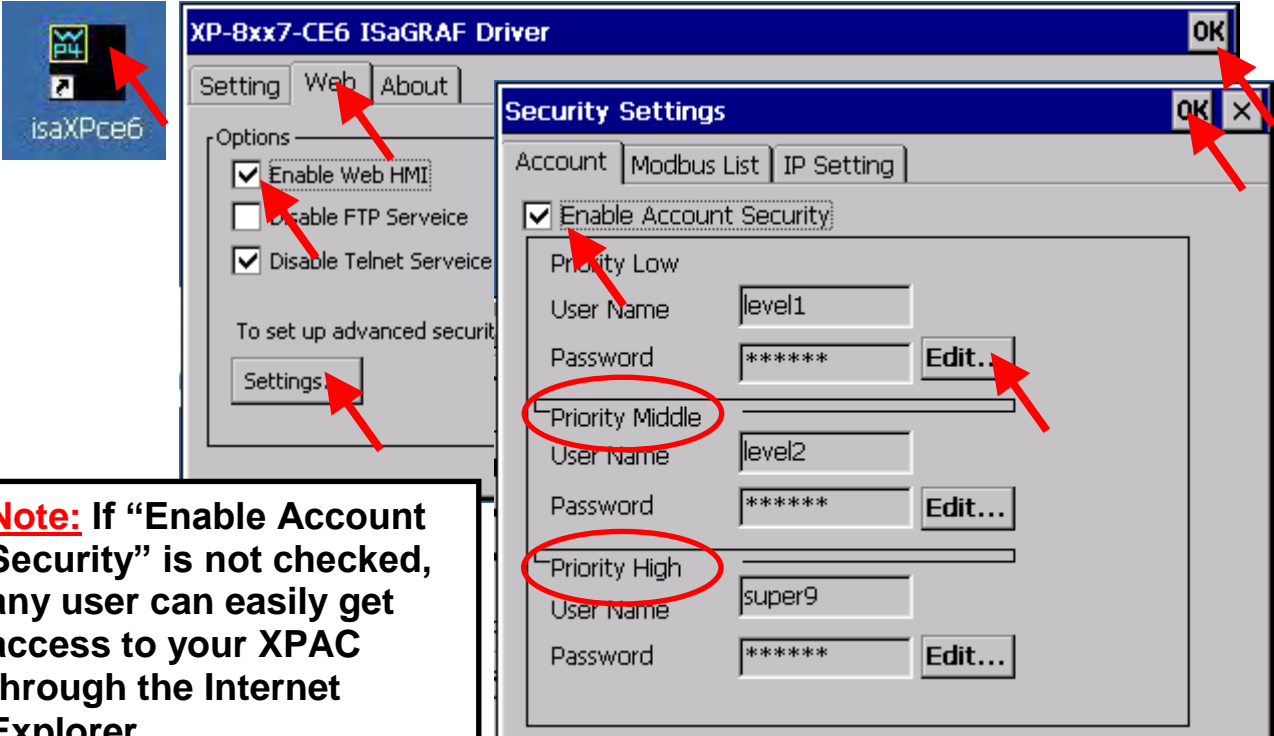

Note: If “Enable Account Security” is not checked, any user can easily get access to your XPAC through the Internet Explorer.

5.5.2 Switch One Page To One Another Page

Please take a look at the “menu.htm” of the “xphmi_05” demo as below. The “goto_R_page()” function can be used for switching to other page.

```
<!-- top_or_left=0 , scrolling=0 , width=110 , resize=1 -->

<html>
<head>
<title>Title1</title>
<meta http-equiv="Content-Type" content="text/html; charset=big5" >
<SCRIPT LANGUAGE="JavaScript" src="./msg/wincon.js"></SCRIPT>

<SCRIPT LANGUAGE="JavaScript">
function start1()
{
  A_11();
}
function refresh_data()
{
  if(run_at_pc==1) return; // if simulate at the PC, just return
  ...
}
</SCRIPT>
</head>
<body onload="start1()">

<!-- Logout button -->
<form name="form_logout" method="post" action="./login.dll">
  <input style="cursor:hand" name="CMD" type="submit" value="Logout"
onClick="return logout(this.form)">
</form>
<br/>
<br/>
<!-- Goto main.htm -->
<A style="cursor:hand" onClick="goto_R_page('main.htm')">第 1 頁</A>
<br/>
<br/>
<!-- Goto kitchen.htm -->
<A style="cursor:hand"
onClick="goto_R_page('kitchen.htm')">Kitchen</A><br/>
<br/>
<br/>
```

“cursor:hand” will display the mouse arrow as a hand when entering the button area

Switch page to “main.htm”

Switch page to “kitchen.htm”

5.6 Web Security

There are some ways user can get access to the XP-8xx7-CE6 via Ethernet port.

1. Using Modbus TCP protocol at port No.= 502. (ISaGRAF & other HMI do this)
2. Using ftp (for example, key in “ftp://10.0.0.103” on the Internet Explorer)
3. Using telnet (for example, key in “telnet 10.0.0.103 in the “command” window)
4. Using the Web server (The Web HMI does)

For safety, recommend to disable item 2 and 3 at run time.

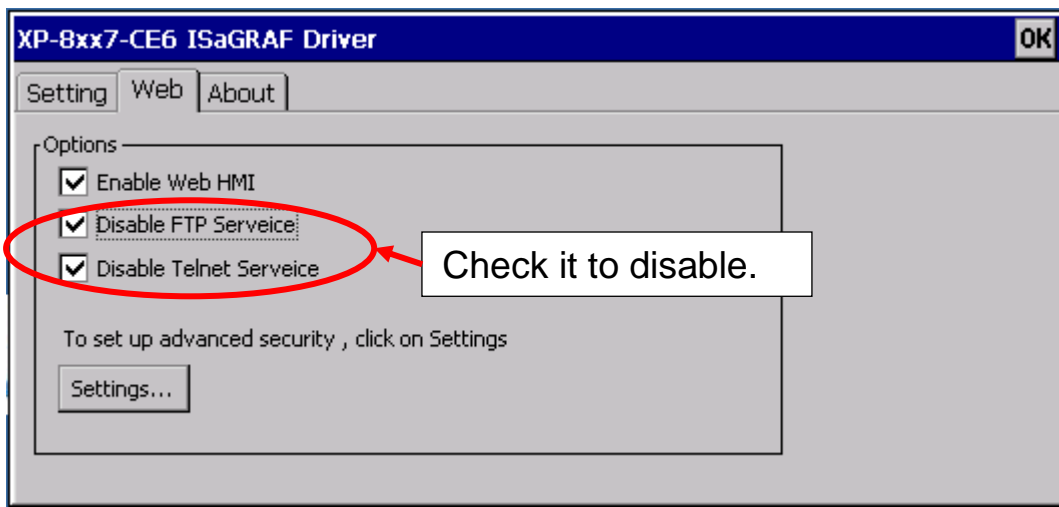

And about item 4, please set proper username & password for the Web HMI.

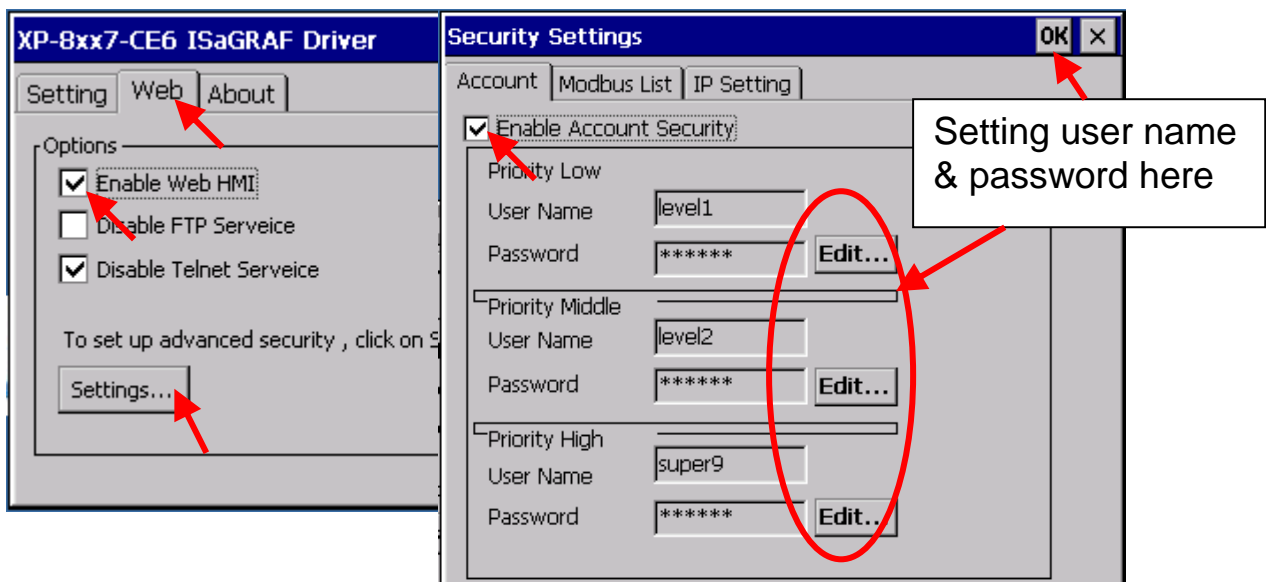

About item 1, user may set up to 8 IP address for ISaGRAF or other HMI to get access to the XP-8xx7-CE6 via the Modbus TCP/IP protocol as below. On the “IO connection” window of ISaGRAF, please connect “vip” and entering the IP which can get access to the XPAC via Modbus TCP/IP protocol. If “vip” is

not connected, any remote IP can get access to your XPAC via Modbus TCP/IP protocol. If “vip” is connected and No IP is entered (all assigned as “N/A”), No HMI and ISaGRAF can get access to it anymore.

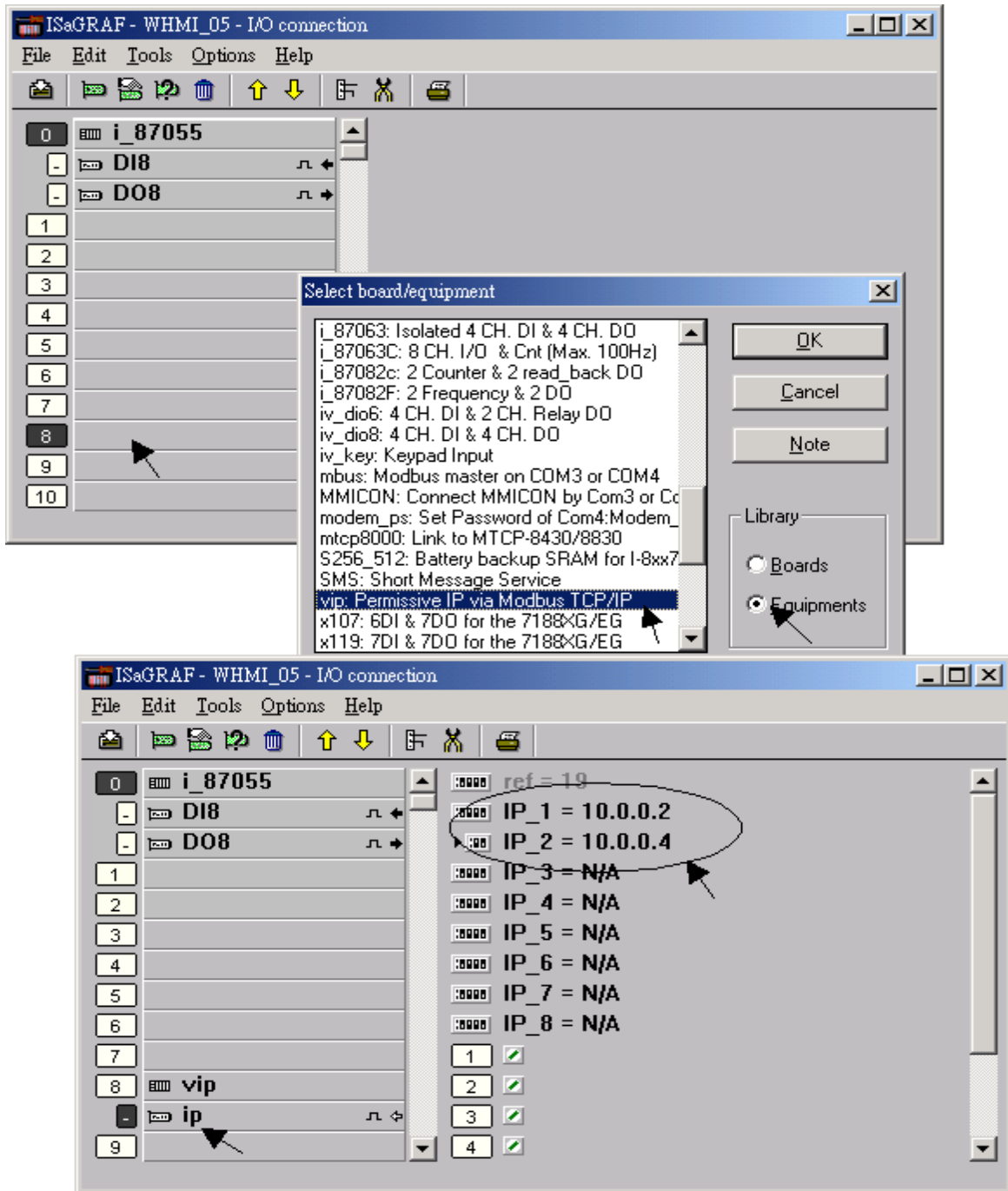

Please re-compile your ISaGRAF project and download it to the controller if you have modified the IO connection.

Chapter 6 VB.net 2008 Program Running In XP-8xx7-CE6 Access To ISaGRAF Variables

This chapter lists the procedure for creating the first demo program by Visual Studio .NET 2008 development tool. There is some sample programs in the XP-8xx7-CE6 CD-ROM.

XP-8xx7-CE6 CD-ROM : [\napdos\isagraf\xp-8xx7-ce6\xpce6-vb.net-2008-demo\](#)

wp_vb01 : Digital I/O demo with one I-87055W in slot 1 of the XP-8xx7-CE6.

wp_vb02 : Analog I/O demo with one I-87024W in slot 2 and one I-8017HW in slot 3.

wp_vb03 : Read / Write ISaGRAF internal integers, timers and real variables. (No I/O)

The related ISaGRAF demo project name are "wp_vb01.pia" , "wp_vb02.pia" and "wp_vb03.pia" in the same directory.

6.1 Create a New Project

1. In the first, users need to open Microsoft Visual Studio .NET 2008 software. And then in the menu of “File”, please run the “New Project” .

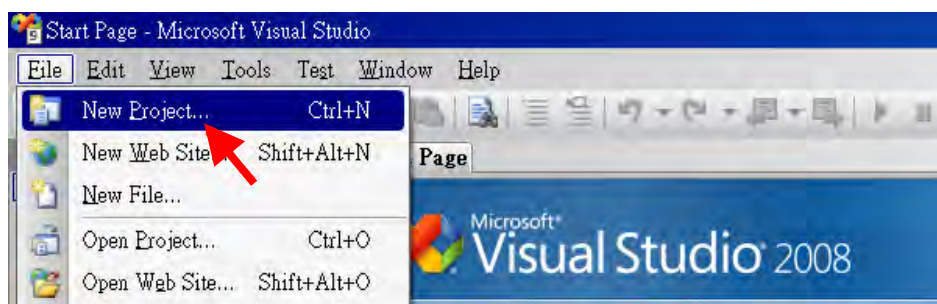

2. Check the “Smart Device” on the left, select the “.NET frame work 3.5” and “Smart Device Project”, then enter a proper project name and click on “OK”.

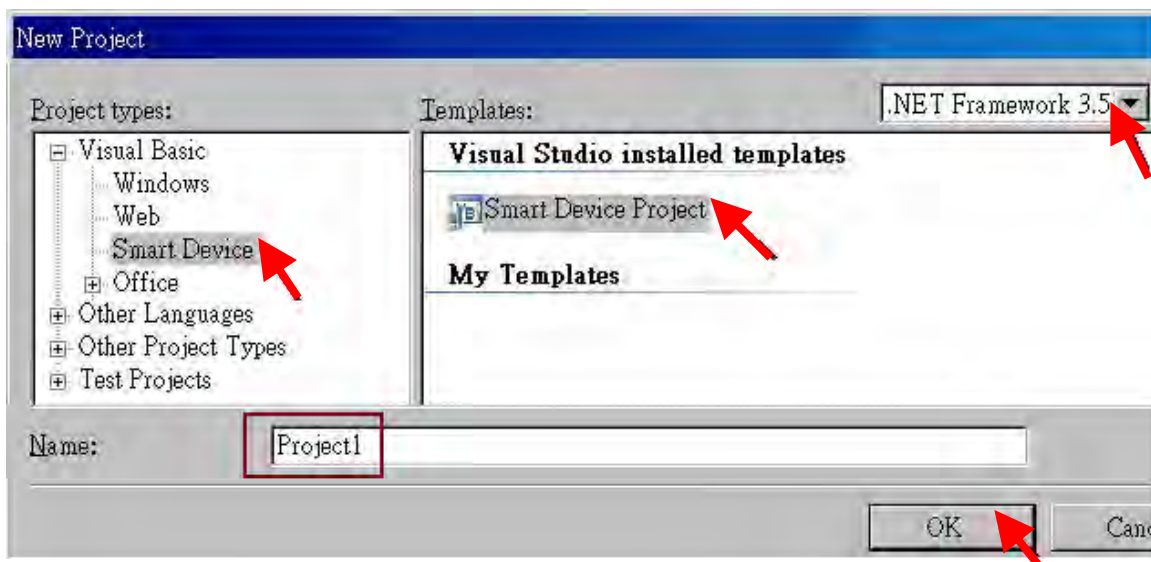

3. Select the "Device Application" and "Windows CE" and ".NET Compact Framework Version 3.5", then click on "OK".

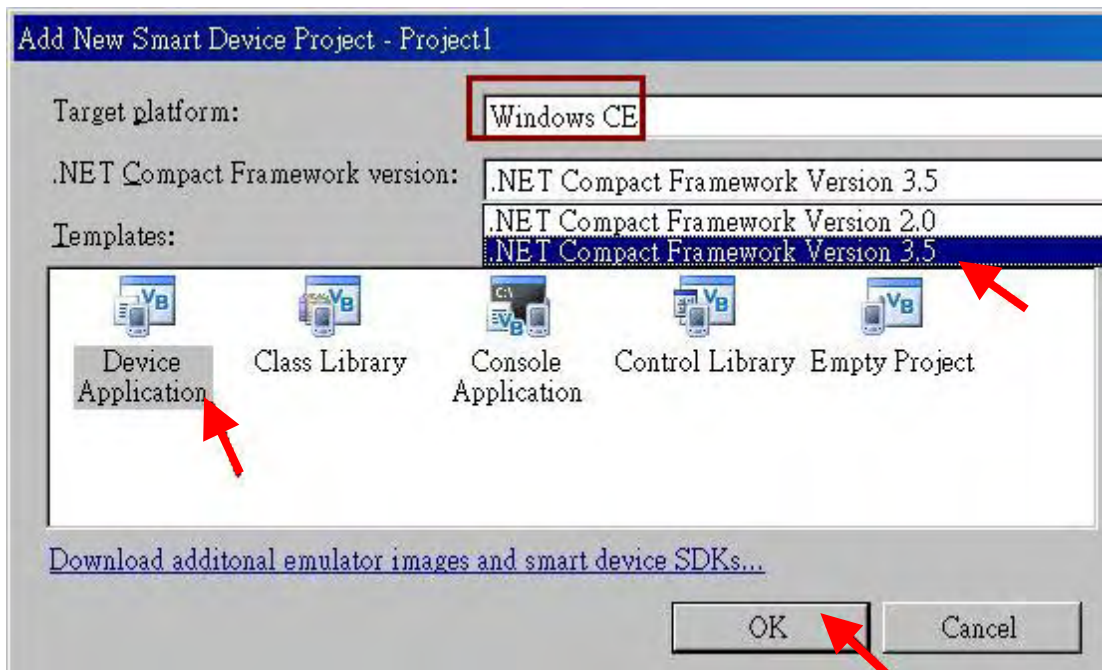

6.2 Add Project Reference for an Application

The "QuickerNet" library contains all modules' functions. Before you use the "Quicker" keyword in the program, you must add the "QuickerNet.dll" into the reference list of your application.

1. Right click on the Project name on the right hand side, then select "Add Reference ..."

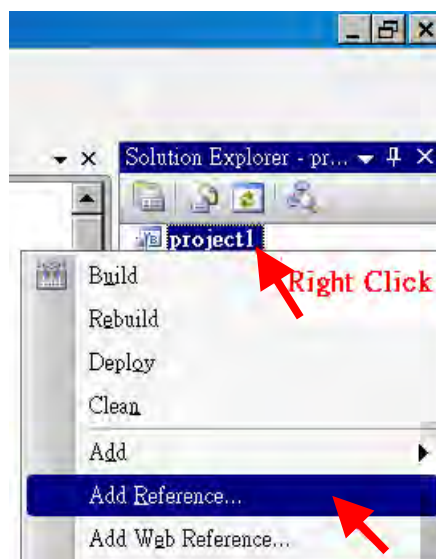

2. Select the “**mscorlib**” in the list box and click the button “**OK**” (the component “**mscorlib**” must appear in the Selected Components area)

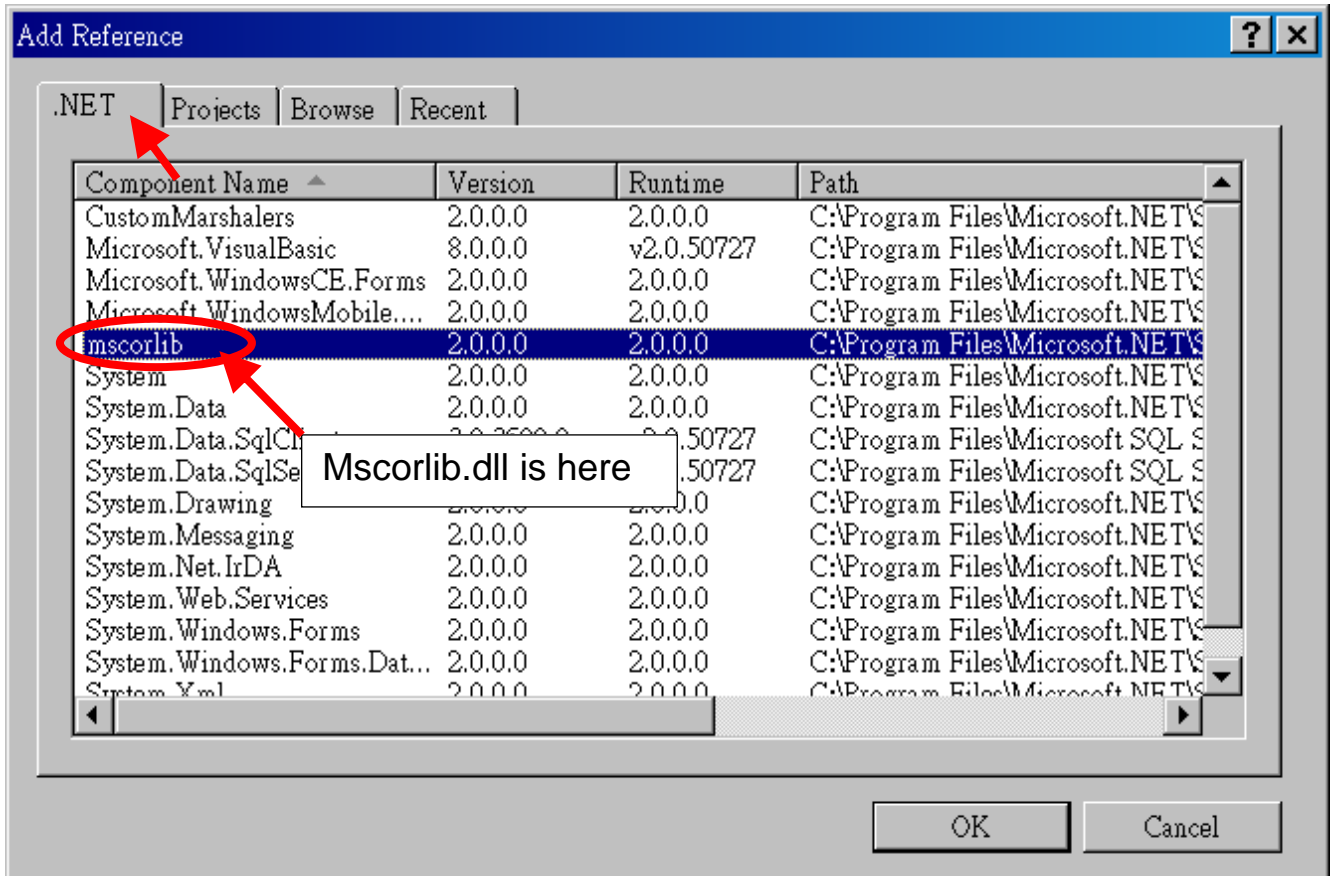

3. Click the “**Browse**” button. Select the “**QuickerNet.dll**” from **XP-8xx7-CE6 CD-ROM** :
[\napdos\isagraf\xp-8xx7-ce6\xpce6-vb.net-2008-demo\wp_vb01\vb01\](#) subfolder or from your own location.

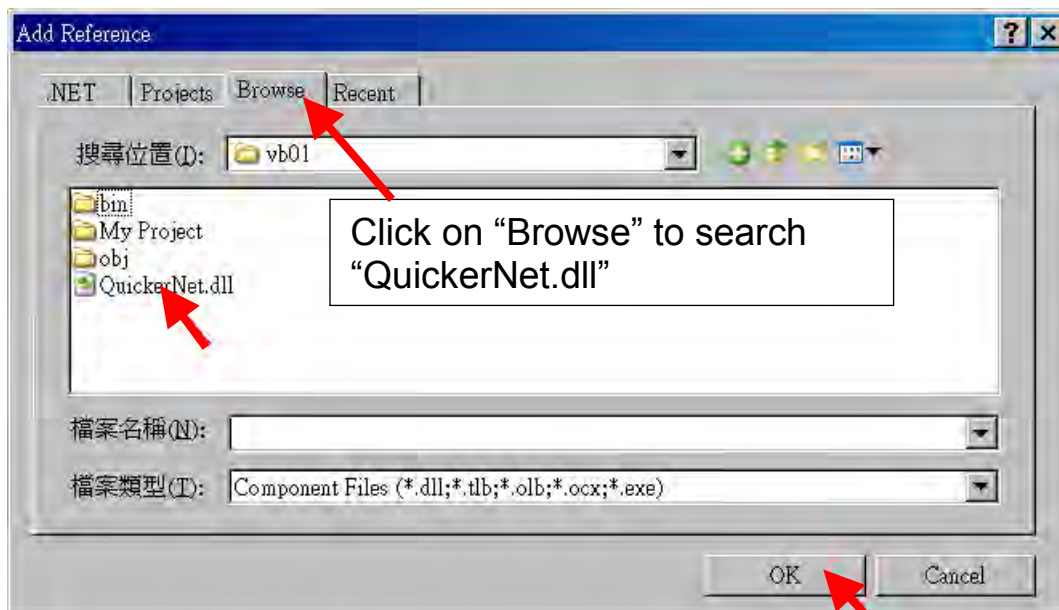

- When both “mscorlib” and “QuickerNet.dll” are added, please double click on “My Project” to check if the “QuickerNet.dll” is well added.

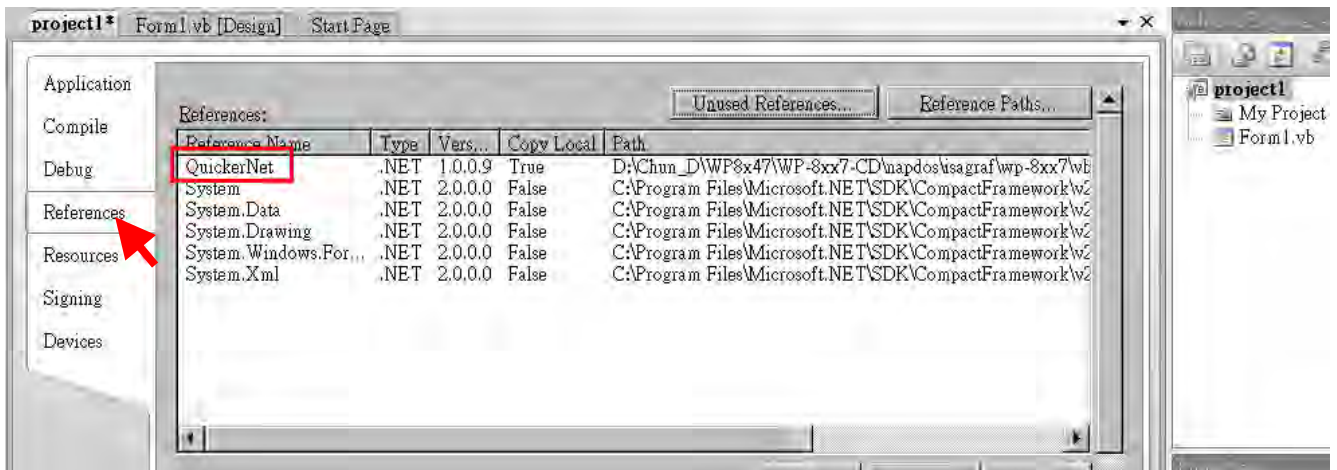
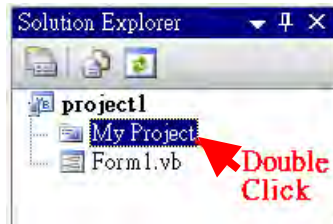

- Right-click on the “Form1.vb” and select “View Code” from the pop-up. Move cursor to top and insert the “Option Explicit On” and “Imports Quicker” in the first two statements.

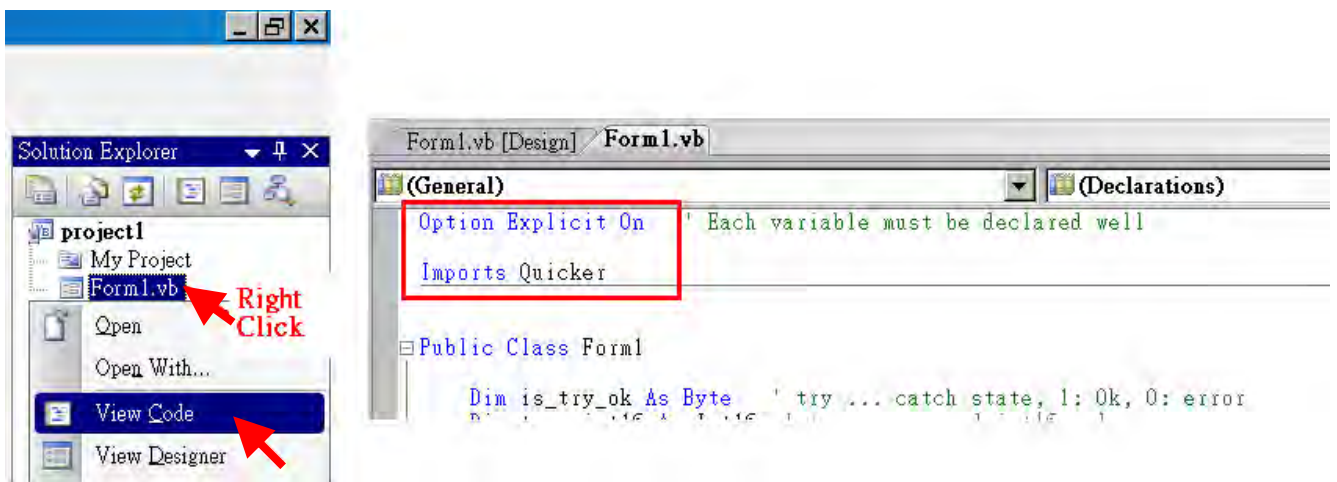

Then you can design all required objects and actions inside your VB Forms .

6.3 Compiling an Application Program

When you have finished writing a program, you can build an application by the following steps.

1. Remember to save at any time for safety.

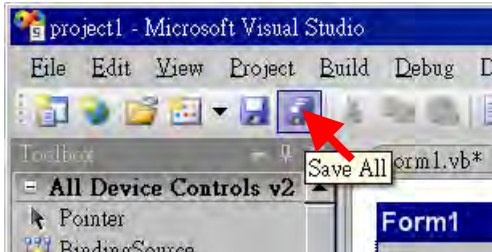

2. Then compile (Build) the project. The result is listed in the "Error List" windows at the bottom.

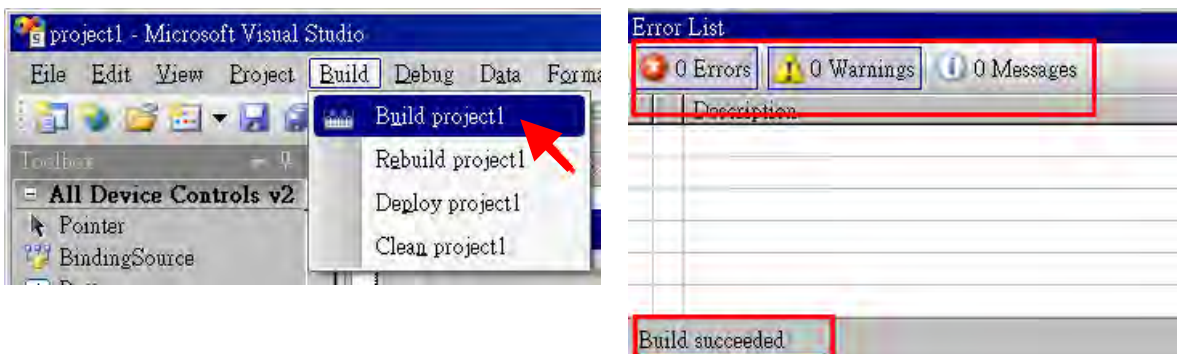

3. You can find the execution file in

<Your VB.net Project folder> \bin\Release\ <project_name>.exe

Please copy this execution file to the XP-8xx7-CE6 's \System_Disk\ISaGRAF\ path to run it.

Note:

User may copy the VB.net execution file to other path to run it but there should contain at least three DLL files with it or it can not run correctly.

For ex, the project1.exe can run in the \System_Disk\User\ path if there are three .dll files plus one .exe file in it.

The "project1.exe" , "QuickerNet.dll" , "Quicker.dll" and "Mscorlib.dll" .

(The "QuickerNet.dll" , "Quicker.dll" and "Mscorlib.dll" can be copied from the XP-8xx7-CE6 's "\System_disk\ISaGRAF\ path)

6.4 QuickerNET.DLL

This section we will focus on the description of the application example of QuickerNET.DLL functions. There are some functions that can be used to R/W data from/to the ISaGRAF softlogic. The functions of QuickerNET.DLL can be clarified as two groups as depicted as below:

1. Digital R/W Functions
2. Analog R/W Functions

6.4.1 Digital R/W Functions

■ UserSetCoil

Description:

This function is to set the value to a Boolean variable by Modbus network address.

Syntax:

UserShare.UserSetCoil (iUserAddress As System.UInt16, iStatus As byte)

Parameter:

iUserAddress : Specify the Modbus Network Address of Variable (1 to 8191)

iStatus : Set the status. For instance, iStatus = 1 for True, iStatus = 0 for False

Return Value:

None

Example:

' Set the output variable of Modbus Network Address "1" to True.

```
UserShare.UserSetCoil(Convert.ToUInt16(1), 1)
```

Demo program :

XPAC-8xx7-CE6 CD-ROM:

[\napdos\isagraf\xp-8xx7-ce6\xpce6-vb.net-2008-demo\wp_vb01](#)

■ UserGetCoil

Description:

This function is to get the value from a boolean variable by Modbus network address.

Syntax:

UserShare.UserGetCoil (iUserAddress As System.UInt16, ByRef iStatus As byte)

Parameter:

iUserAddress : Specify the Modbus Network Address of Variable (1 to 8191)

iStatus : Get the variable status , iStatus = 1 for True, iStatus = 0 for False

Return Value:

None

Example:

' Get the variable status of Network Address "1".

Dim iStatus As Byte

UserShare.UserGetCoil(Convert.ToUInt16(1), iStatus)

Demo program :

XP-8xx7-CE6 CD-ROM:

\\napdos\isagraf\xp-8xx7-ce6\xpce6-vb.net-2008-demo\wp_vb01

6.4.2 Analog R/W Functions

■ **UserSetReg_short** ■ **UserSetReg_long** ■ **UserSetReg_float**

Description:

These functions are to set 16-bit short integer , 32-bit long integer & 32-bit float value to the specified Modbus network address.

Syntax:

UserShare.UserSetReg_Short (ByVal iUserAddress As System.UInt16, ByRef iStatus As Integer) As Byte

UserShare.UserSetReg_Long (ByVal iUserAddress As System.UInt16, ByRef iStatus As Integer) As Byte

UserShare.UserSetReg_Float (ByVal iUserAddress As System.UInt16, ByRef iStatus As Single) As Byte

Parameter:

iUserAddress : Specify the Network Address of Variable (1 to 8191)

iStatus : Set the short or long integer or float value.

Example:

' Set a long value "1234567" to the variable of Modbus Network Address "1".

```
UserShare.UserSetReg_long(Convert.ToUInt16(1), Convert.ToInt32(1234567) )
```

' Set a short value "-1234" to the variable of Modbus Network Address "3".

```
UserShare.UserSetReg_short(Convert.ToUInt16(3), Convert.ToInt16(-1234) )
```

' Set a float value "2.174" to the variable of Modbus Network Address "4".

```
UserShare.UserSetReg_float(Convert.ToUInt16(4), Convert.ToSingle(2.174) )
```

Demo program :

XP-8xx7-CE6 CD-ROM:

1. [\napdos\isagraf\xp-8xx7-ce6\xpce6-vb.net-2008-demo\wp_vb02](#)
for R/W analog I/O
2. [\napdos\isagraf\xp-8xx7-ce6\xpce6-vb.net-2008-demo\wp_vb03](#)
for R/W internal long integer, Timer and Real (floating-point) values.

Note:

The long integer & timer & real variable's Network Address No. must occupy 2 No. in the ISaGRAF project.

(Refer to section 4.2 of "User's Manual of ISaGRAF PACs" or in the CD-ROM:\napdos\isagraf\xp-8xx7-ce6\english-manu\ "User_Manual_I_8xx7.pdf")

■ [UserGetReg_short](#) ■ [UserGetReg_long](#) ■ [UserGetReg_float](#)

Description:

These functions are to get 16-bit short integer , 32-bit long integer & 32-bit float value from the specified Modbus network address.

Syntax:

**UserShare. UserGetReg_Short (ByVal *iUserAddress* As System.UInt16,
ByRef *iStatus* As Integer) As Byte**

**UserShare. UserGetReg_Long (ByVal *iUserAddress* As System.UInt16,
ByRef *iStatus* As Integer) As Byte**

**UserShare. UserGetReg_Float (ByVal *iUserAddress* As System.UInt16,
ByRef *iStatus* As Single) As Byte**

Parameter:

iUserAddress : Specify the Network Address of Variable (1 to 8191)

iStatus : Get the short or long integer or float value.

Example:

Dim float_val As Single

Dim short_val As Int16

Dim long_val As Int32

' Get float value of the variable of Modbus Network Address "7".

UserShare.UserGetReg_float(Convert.ToUInt16(7), float_val)

' Get long value of the variable of Modbus Network Address "9".

UserShare.UserGetReg_long(Convert.ToUInt16(9), long_val)

' Get short value of the variable of Modbus Network Address "11".

UserShare.UserGetReg_short(Convert.ToUInt16(11), short_val)

Demo program :

XP-8xx7-CE6 CD-ROM:

1. [\napdos\isagraf\xp-8xx7-ce6\xpce6-vb.net-2008-demo\wp_vb02](#)
for R/W analog I/O
2. [\napdos\isagraf\xp-8xx7-ce6\xpce6-vb.net-2008-demo\wp_vb03](#)
for R/W internal long integer, Timer and Real (floating-point) values.

Note:

The long integer & timer & float variable's Network Address No. must occupy 2 No. in the ISaGRAF project.

(Refer to section 4.2 of "User's Manual of ISaGRAF PACs" or in the CD-ROM:\napdos\isagraf\xp-8xx7-ce6\english-manu\ "User_Manual_I_8xx7.pdf")

Chapter 7

Reserved.

Chapter 8 InduSoft Project Running In XPAC Access To ISaGRAF Variables

Note:

If the HMI program behavior is slow or not smooth, please refer to [Appendix F](#).

The XP-8xx7-CE6 is the abbreviation of the XP-8047-CE6/8347-CE6/8747-CE6.
The XP-8xx6-CE6 is the abbreviation of the XP-8046-CE6/8346-CE6/8746-CE6.

Important Notice:

1. Please always set a **fixed IP** address to the XP-8xx7-CE6/8xx6-CE6. (**No DHCP**)
2. Recommend to use NS-205 or NS-208 Industrial Ethernet Switch for XPAC.
3. Please refer to XP-8xx7-CE6 CD-ROM:
[\napdos\isagraf\xp-8xx7-ce6\english-manu\ "user_manual_i_8xx7.pdf"](#) for detailed ISaGRAF English User's Manual.
4. XP-8xx6-CE6 supports InduSoft and ISaGRAF logic running in the same controller.

A simple example to run InduSoft & ISaGRAF logic in the same PAC:

Step 1: Create a new ISaGRAF project as below.

This demo uses a DI/O module I-87055W in slot 1 of XP-8xx6-CE6, and an AO module I-87024W in slot 2 and one internal variable defined as follow.

Variable Type	Name	Network Address	Comment	Attributes
Boolean	DI_1	1	87055W DI channel 1	Input
Boolean	DO_1	11	87055W DO channel 1	Output
Integer	AO_1	21	87024W AO channel 1	Output
Integer	Interior	31	Internal variable	Internal

If you are not familiar with ISaGRAF, please refer to [section 4.1 to 4.3](#).
And setup the I/O connection as following.

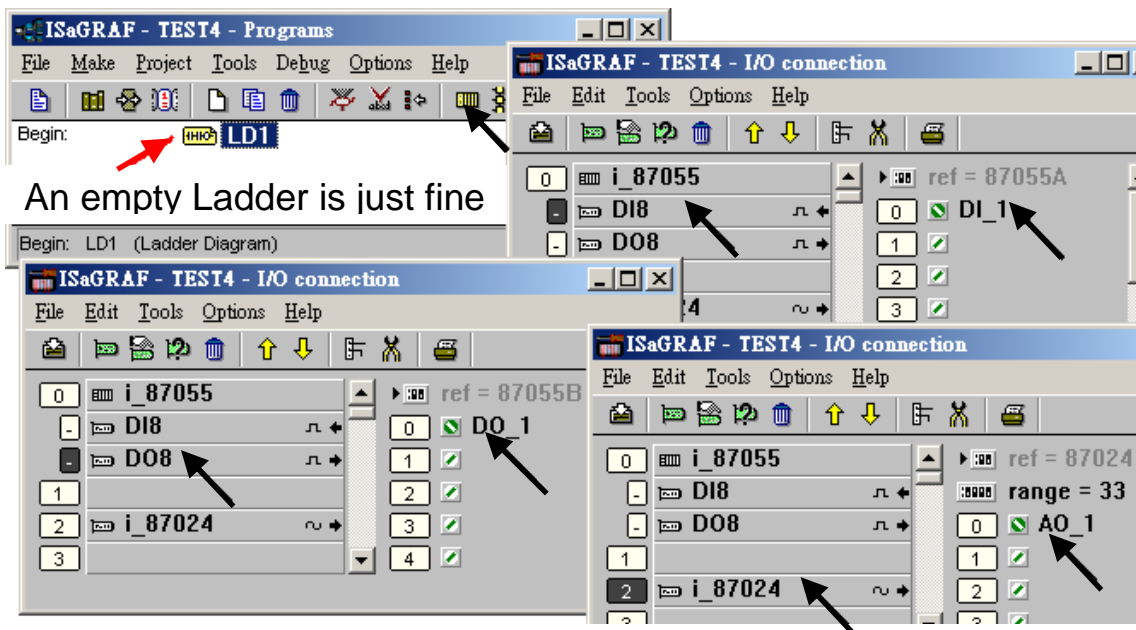

The ISaGRAF variables to be exchanged with InduSoft must be declared with a Modbus “Network Address” as below.

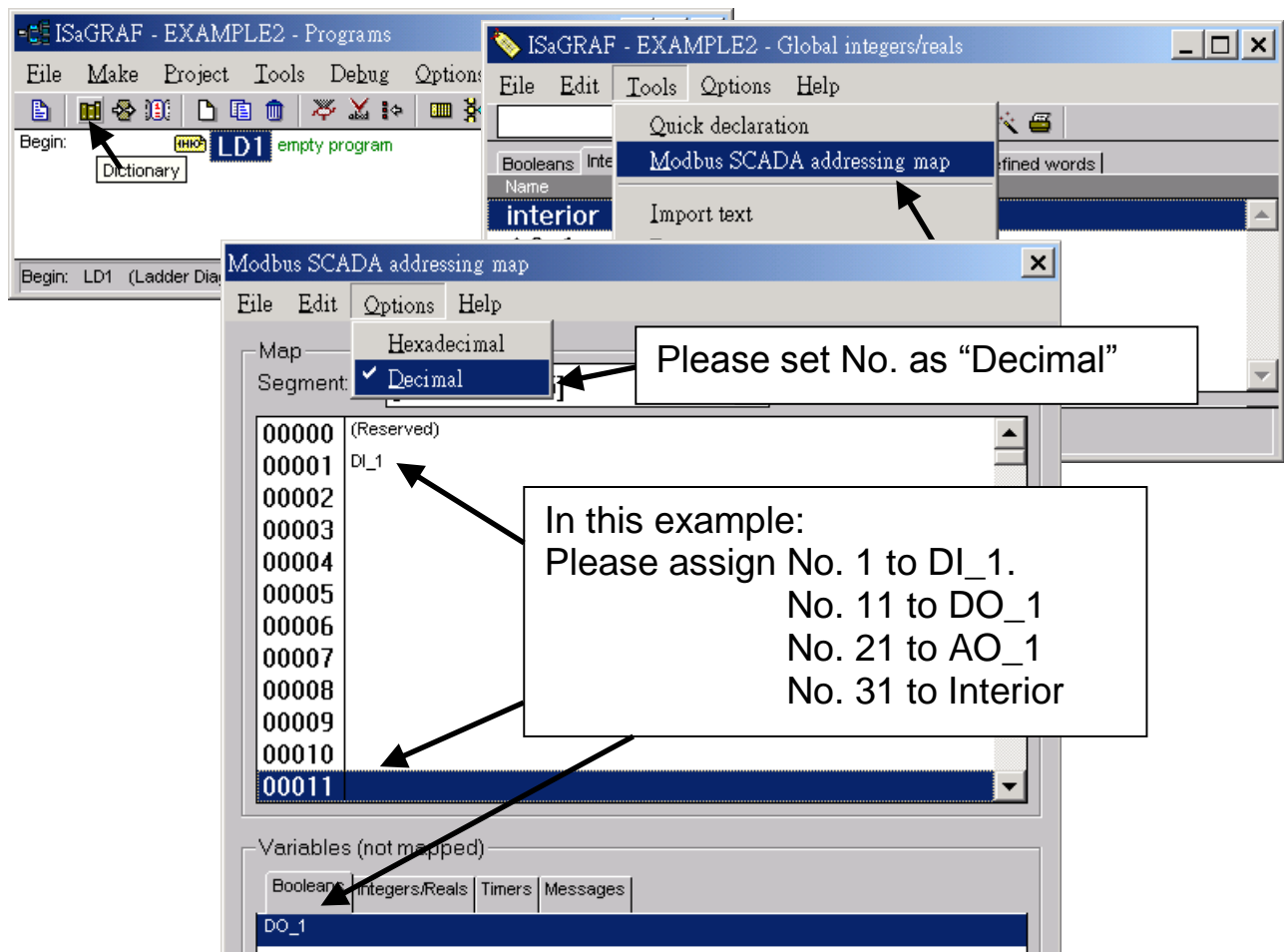

Please save & compile the ISaGRAF example project & then download to the XP-8xx6-CE6. If you are not familiar with it, please refer to [Section 4.1 to 4.3](#)

Step 2: Create an InduSoft project.

1. Select [File] > [New] from the “InduSoft Web Studio” main menu
2. The “New” window will appear and click on “Project” tab. Then type in the name for the new user’s project in the “Application name” and select “CEView Lite” in the “Target”. Press “OK”
3. The “Project Wizard” window will appear. Select “Empty Application” on the “Template”, “320 x 240” on the “Resolution” and “None” on the “Shared Tags”.

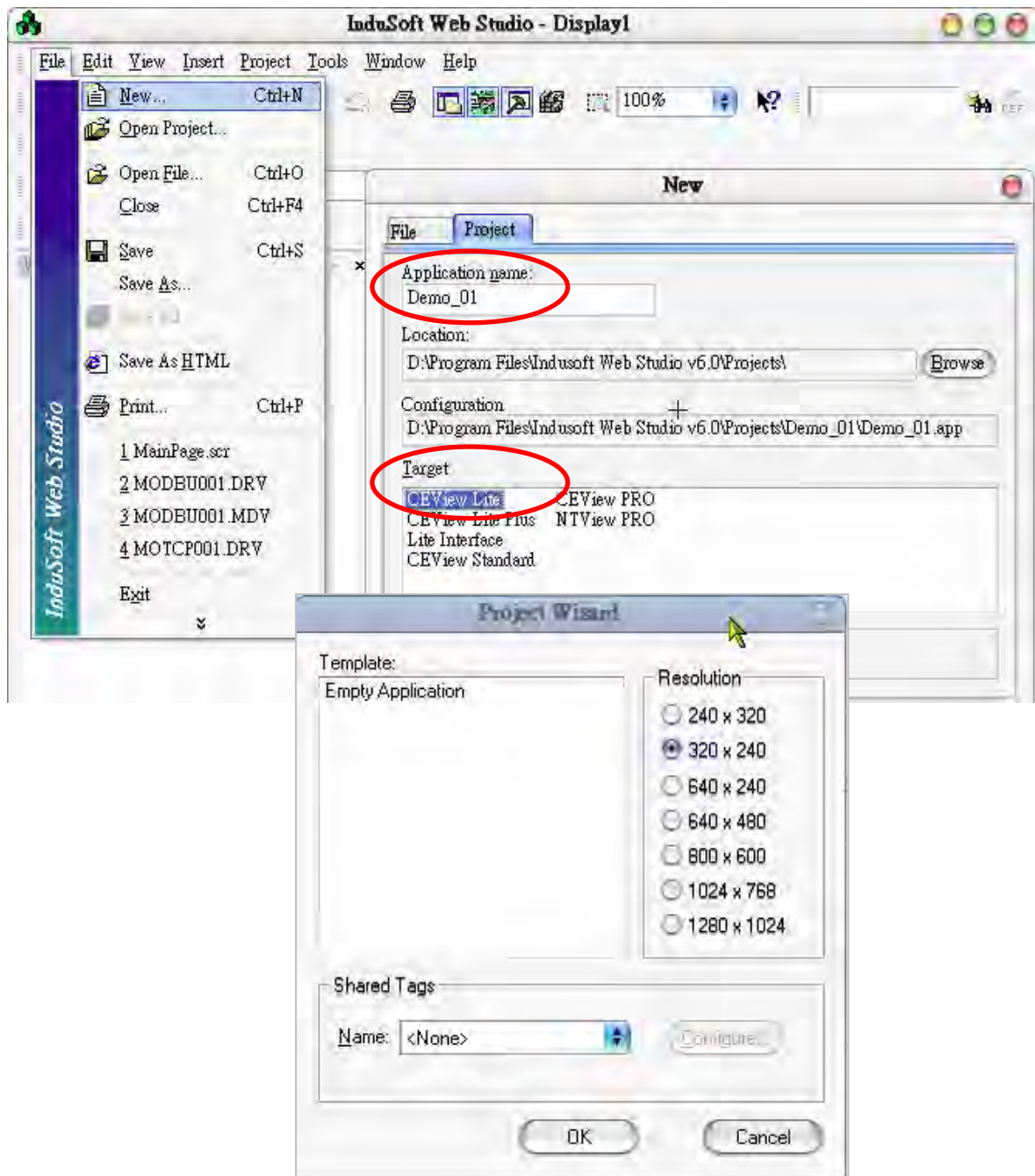

Now you could see the new project shown on the “Workspace” window as below.

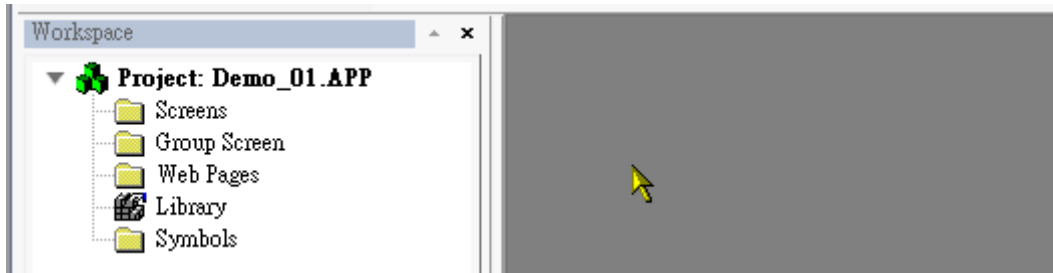

Define application tags

Select [Insert] > [Tag] on the main menu bar or click on the right button of the mouse in the “Database” tab of the “Workspace”.

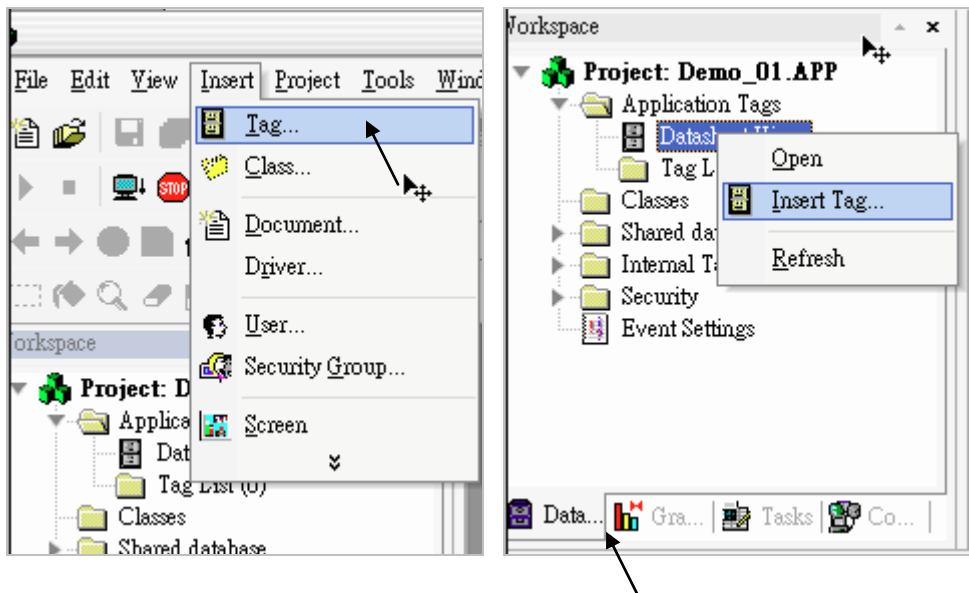

The “New Tag” window will show as below.



This demo uses a DIO module I-87055W, an AO module I-87024W and one internal variable defined as follow. Please create these tags one by one.

Type	Name	Array Size	Description	Web Data
Boolean	DI	0	87055W DI channel 1	Input
Boolean	DO	0	87055W DO channel 1	Output
Integer	AO	0	87024W AO channel 1	Output
Integer	Interior	0	Internal variable	Internal

Create main screen

1. Select the “Graphics” tab in the “Workspace” window.
2. Click mouse right button in the file folder of “Screen”. The “Screen Attributes” window appears.
3. Setting screen attributes such as “Size”, “Location”, “Runtime Properties” and “Background Picture” then press “OK” to edit screen.

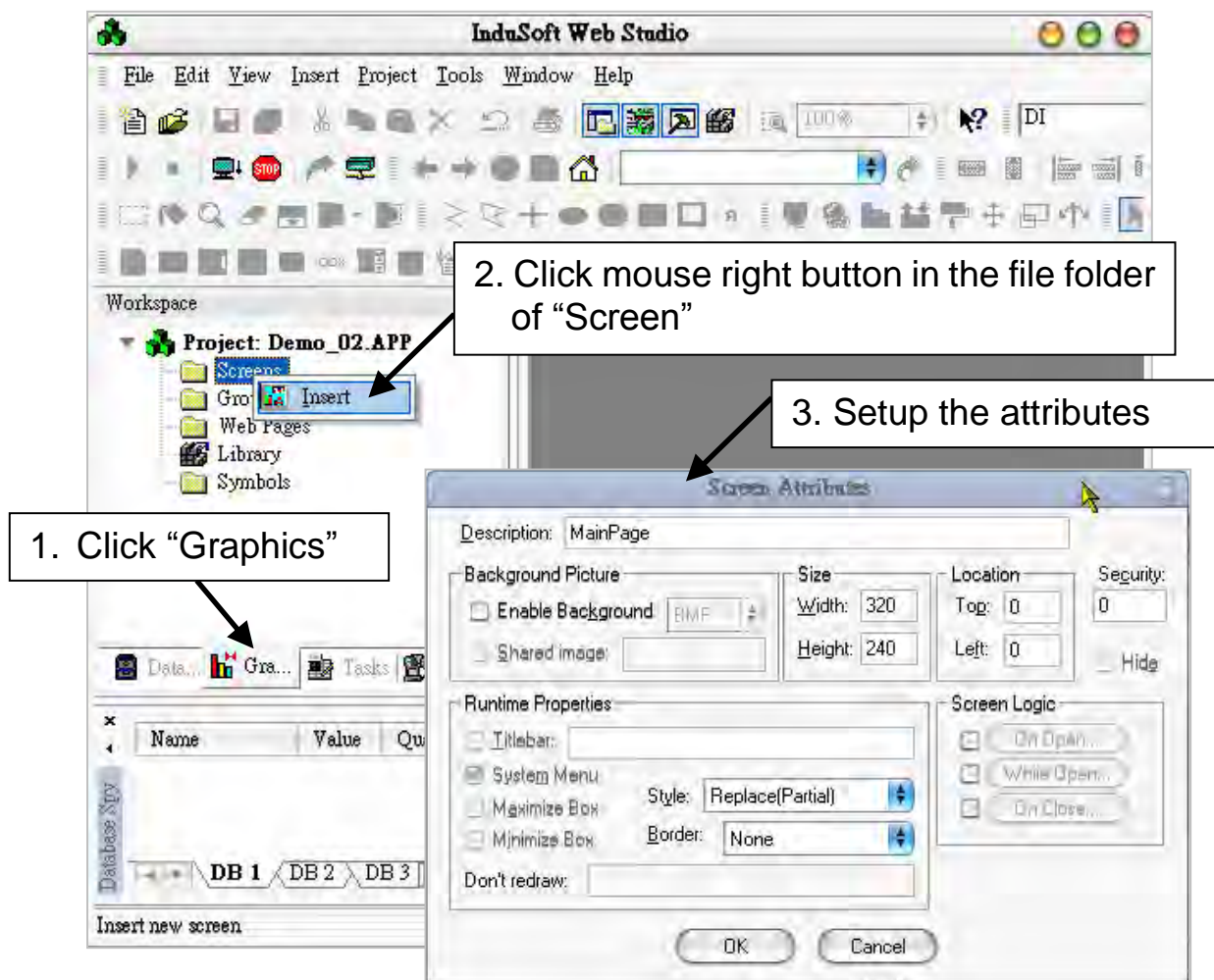

4. Select “Text” icon, then click on the main screen where want to establish a text and type “87055W_DI_1”.
5. Select “Text” again following the previous text and type “#” then select “Text I/O” (# means 1 digit, ##### means 4 digits, ##### means 6 digits)

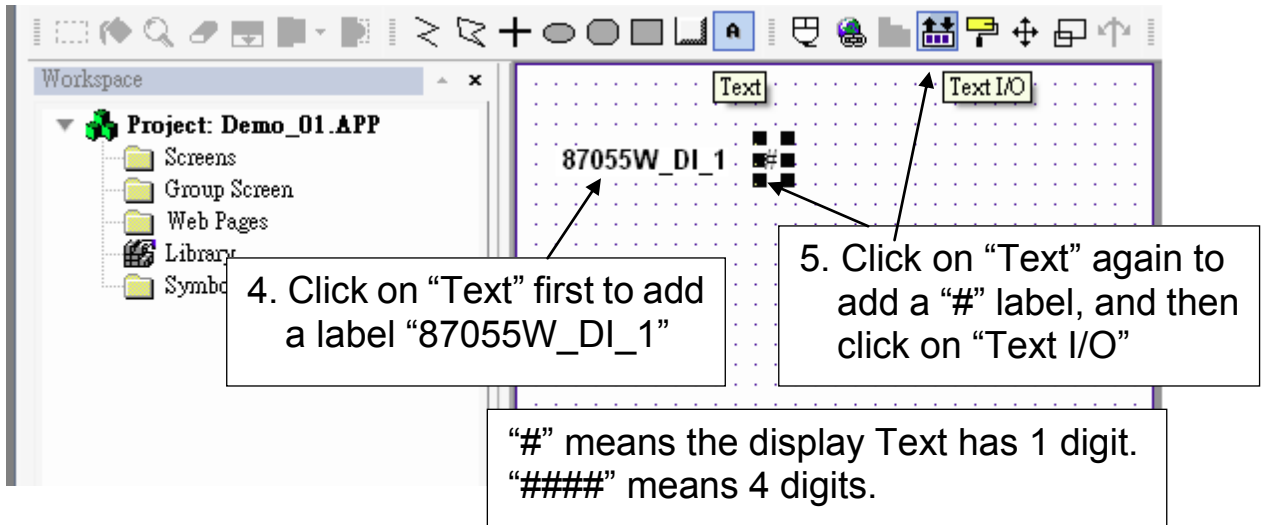

6. Double click the “#” object and the “Object Properties” window will show as below then type DI in the “Tag/Expression”.

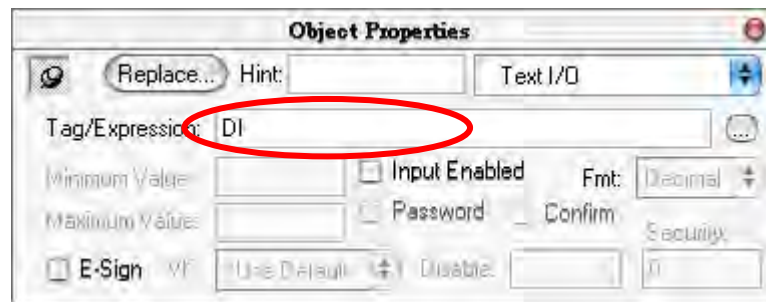

Repeat former method to create other objects and click “Save” icon on the main menu to save this main screen page as “MainPage.scr”. (**Select [File] > [Save As HTML]** to create this screen that can be visualized in a remote station using the IE web browser.)

Note: For the Output object, as 87024W_AO_1 and 87055W_DO_1, the “Input Enabled” of the “Text I/O” should be checked as below.

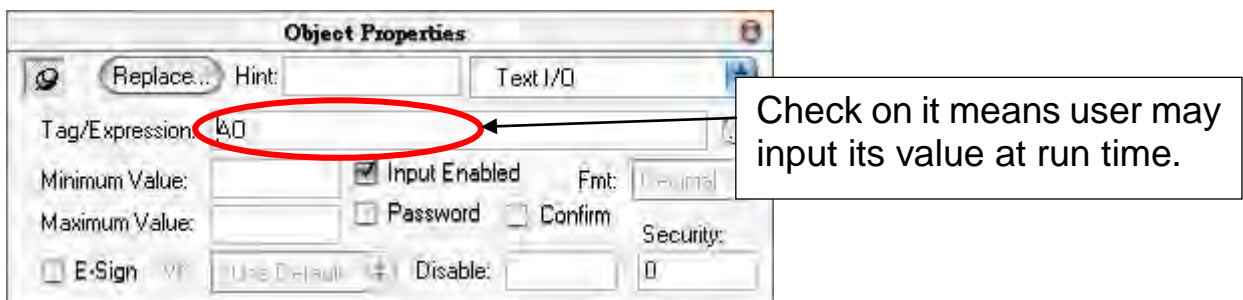

The main screen is as below.

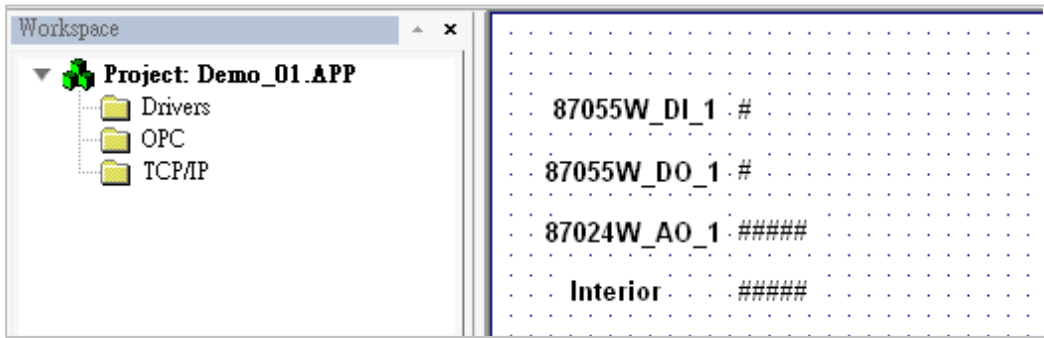

Create Modbus TCP workspace

1. Click "Comm" in the "Workspace"
2. Click mouse right button on the folder of "Drivers", and select "Add/Remove drivers" to open "Communication Drivers" window as below.
3. Click "MOTCP" driver then click "Select" and click "OK" to close this window.

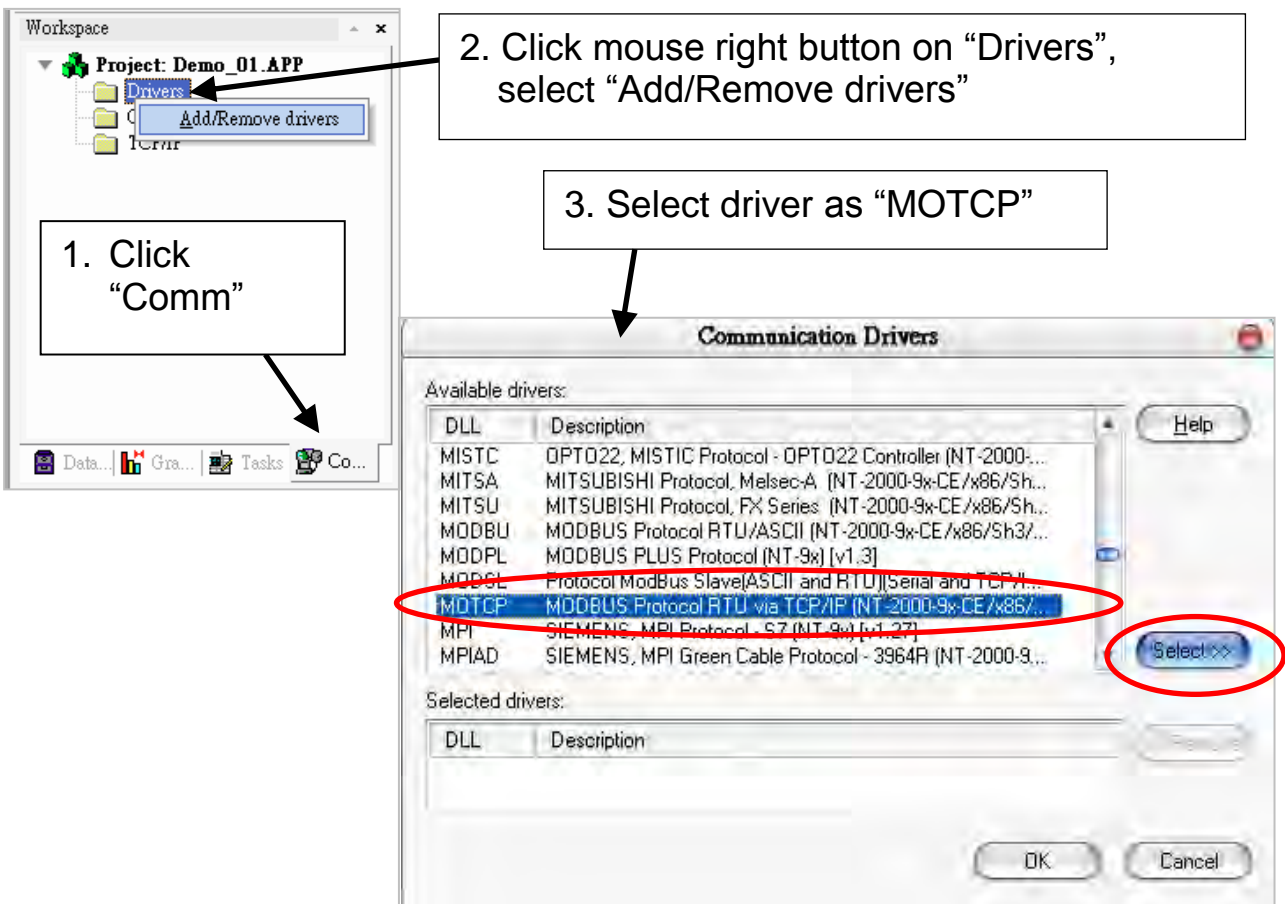

Expanding file folder of “Drivers” and it will show a file folder named “MOTCP”. Click right mouse button and select “Insert” to add a workspace of Modbus TCP. When a “MOTCP001.DRV” window appears, fill in following data as corresponding field.

Click on mouse right button on “Insert”

What does “127.0.0.1:502:1” mean?
 “127.0.0.1” is the local host IP address. It means send data to the same controller.
 “502” is the Modbus TCP/IP port No..
 The last “1” is the Net-ID of the XPAC.

Station: 127.0.0.1:502:1 Header: 1X:0

	Tag Name	Address	Div	Add
1	DI	1		

1X:0 is for reading “Boolean” data
 0X:0 is for writing “Boolean” data”
 3X:0 is for reading short “integer” data (16-bit integer, Word: -32768 to +32767)
 4X:0 is for writing short “integer” data (16-bit integer , Word: -32768 to +32767)
 DW:0: is for reading & writing long “integer” (32-bit integer, Double Word)
 FP:0: is for reading & writing floating point data (32-bit REAL)
 For more details, please refer form as below

Data Type	Sample Syntax	Valid Range of Initial Addresses per Worksheet	Comments
0X	0X:1	Varies according to the equipment	Coil Status: Read and write events using Modbus instructions 01, 05, and 15
1X	1X:5	Varies according to the equipment	Input Status: Read events using Modbus instructions 02
3X	3X:4	Varies according to the equipment	Input Register: Read events using Modbus instruction 04
4X	4X:5	Varies according to the equipment	Holding Register: Read and write events using Modbus instructions 03, 06, 16
FP	FP:1	Varies according to the equipment	Floating-point value (Holding Register): Read and write float-point values using two consecutive Holding Registers.
FP3	FP3:1	Varies according to the equipment	Floating-point value (Input Register): Read float-point values using two consecutive Input Registers.
DW	DW:2	Varies according to the equipment	32-bit Integer value (Holding Register): Read and write 32-bit integer values using two consecutive Holding Registers.

DRV Name	MOTCP001. DRV	MOTCP002. DRV	MOTCP003. DRV	MOTCP004. DRV
Description	DI	DO	AO	Internal
Station	127.0.0.1:502:1			
Header	1X:0	0X:0	4X:0	3X:0
Tag Name	DI	DO	AO	Interior
Enable Read when Idle	1			1
Enable Write on Tag Change		1	1	
Address	1	11	21	31

When finished all setting, press “Ctrl + F4” to close all inside windows and save all files.

Project Setting

Select [Project] > [Settings] to open “Project Settings” window. Click the tab of “Runtime Desktop”. In the “Startup screen” edit box, fill in “MainPage.scr” then click “OK” to close this window.

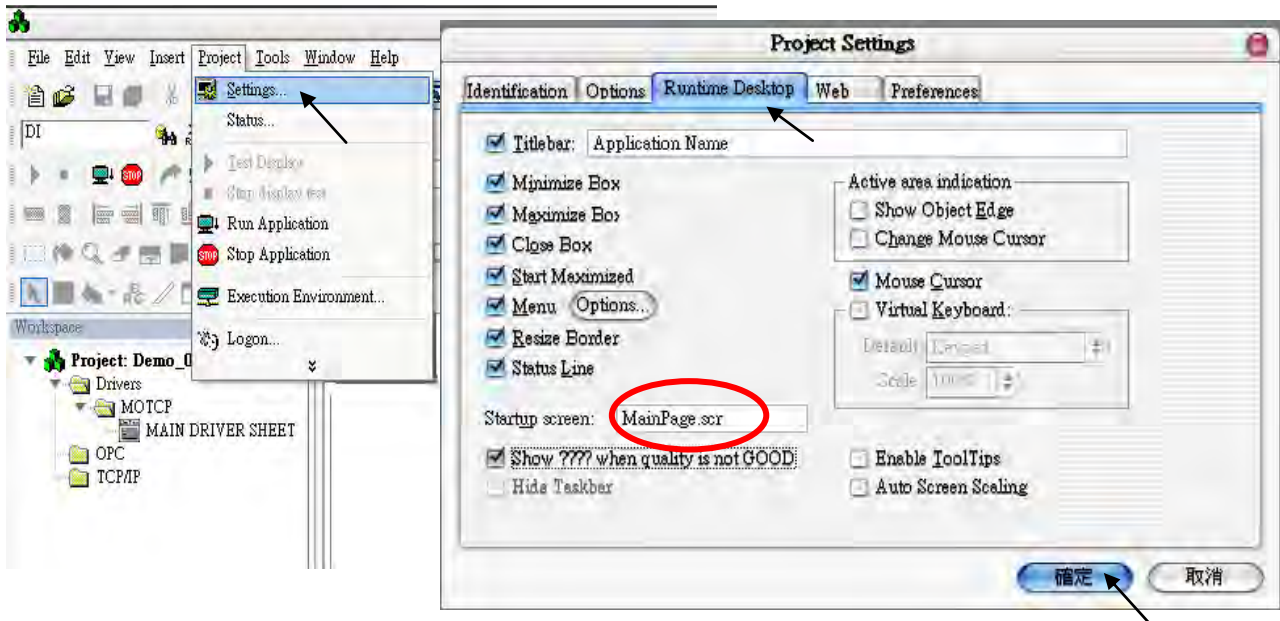

Web Thin Clients

Select [Project] > [Settings] to open “Project Settings” window. On the Web tab, select “Data Server IP Address” then type XP-8xx6-CE6’s correct IP address and click “OK”.

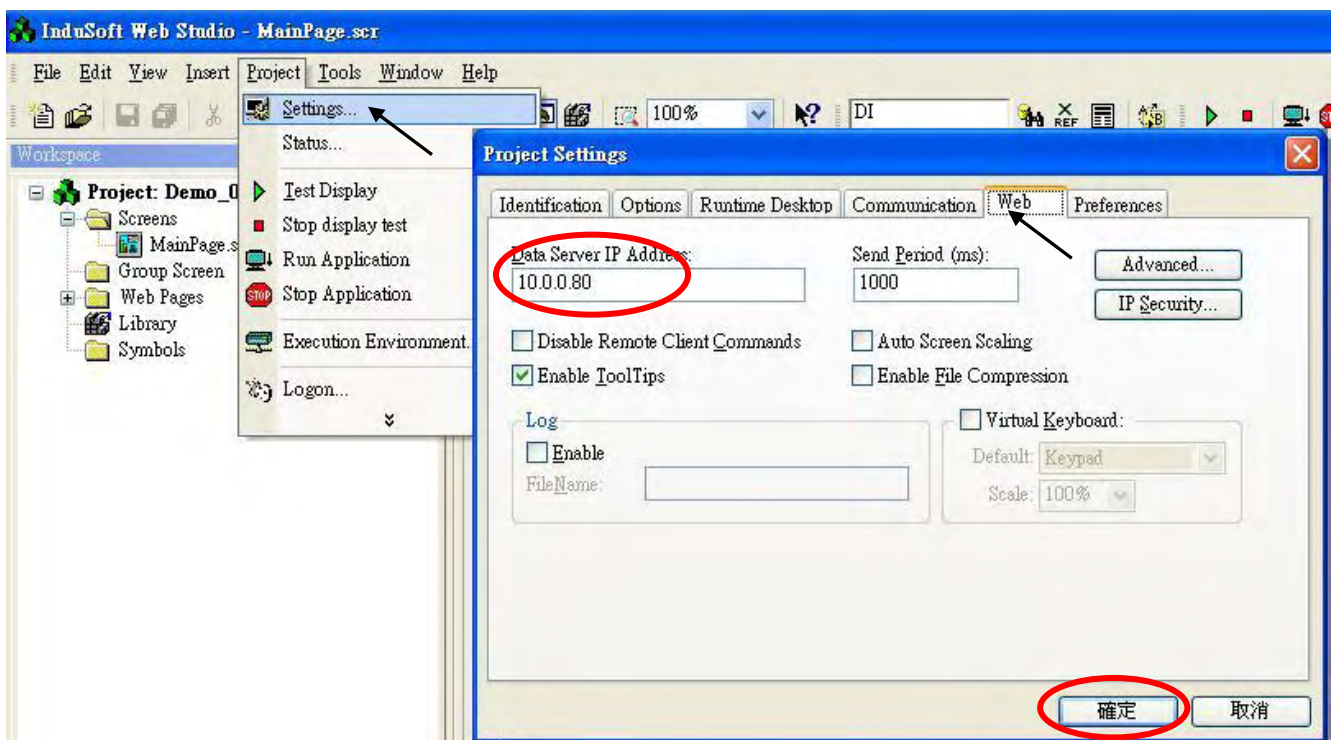

Download and run the project

Select [Project] > [Execution Environment] to open “Execution Environment” window. On the Target tab, select “Network IP” then type WP-8xx6’s correct IP address and click “Connect”.

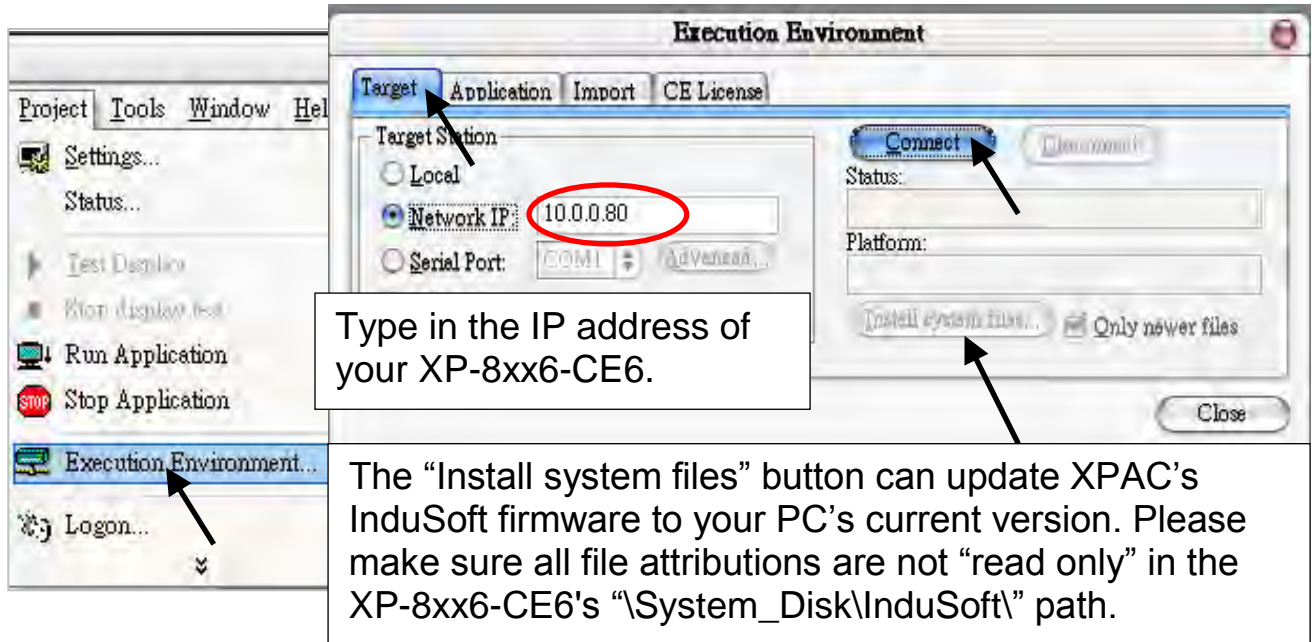

If connection is fine, click on the tab of “Application” then click “Send to Target”. When download finished, click “RUN” to start the project.

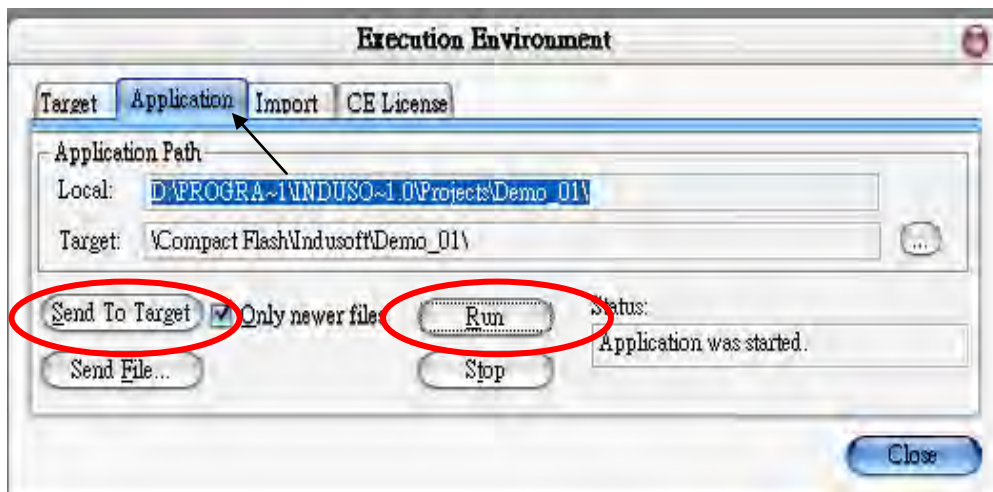

Configuration Web directory of XPAC

Run XPAC_Utility, click “Network” page tag, and change the Web directory to “\System_Disk\InduSoft\Demo_01\Web”. Click “Apply” to finish this configuration.

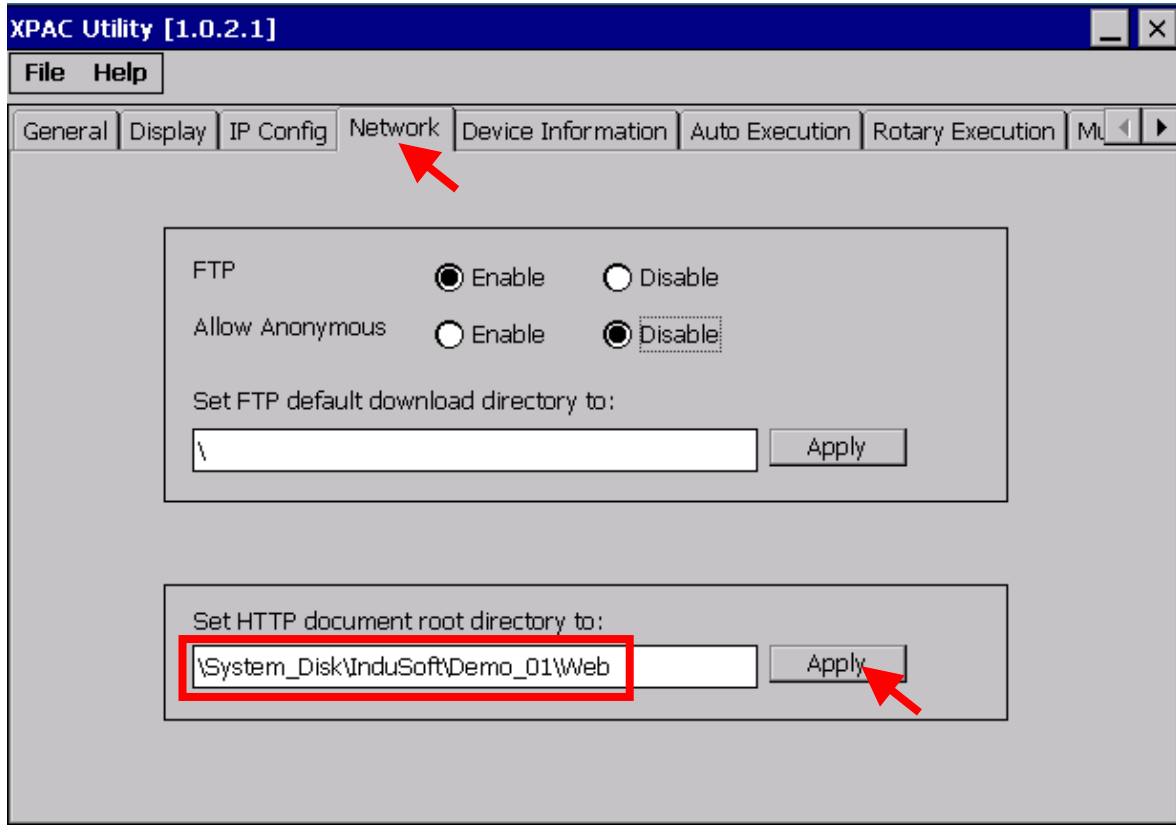

Visualize your project in a remote station

Run Internet Explorer and type for ex. "<http://10.0.0.80/MainPage.html>". (use your XPAC's IP)



Note:

Users must install ISSymbol control layer in a remote station at first time. The procedure to install ISSymbol in each operation system is described below:

- **Windows NT/2000/XP:**

Copy the files :

ISSymbolReg.exe
ISSymbol.cab

from the **\BIN** sub-folder of InduSoft Web Studio v6.1 and paste them in any directory of the Web Thin Client station. Make sure that both files are stored in the same directory.

Run **ISSymbolReg.exe** to register ISSymbol control in the Web Thin Client station.

- **Windows 9x/ME:**

Copy the files :

ISSymbolReg.exe
ISSymbolA.cab

from the **\BIN** sub-folder of Indusoft Web Studio v6.1 and paste them in any directory of the Web Thin Client station. Make sure that both files are stored in the same directory.

Run **ISSymbolReg.exe** to register ISSymbol control in the Web Thin Client station.

Chapter 9 Example Program & FAQ

The XP-8xx7-CE6 is the abbreviation of the XP-8047-CE6/8347-CE6/8747-CE6.
The XP-8xx6-CE6 is the abbreviation of the XP-8046-CE6/8346-CE6/8746-CE6.

Please refer to XP-8xx7-CE6 CD-ROM for detailed ISaGRAF English User's Manual.

CD-ROM: <\\napdos\isagraf\xp-8xx7-ce6\english-manu\>

"user_manual_i_8xx7.pdf" & "user_manual_i_8xx7_appendix.pdf"

9.1 Get On-Line Help

If you have any question, you may email to service@icpdas.com.

On-line help of ISaGRAF standard functions & function blocks:

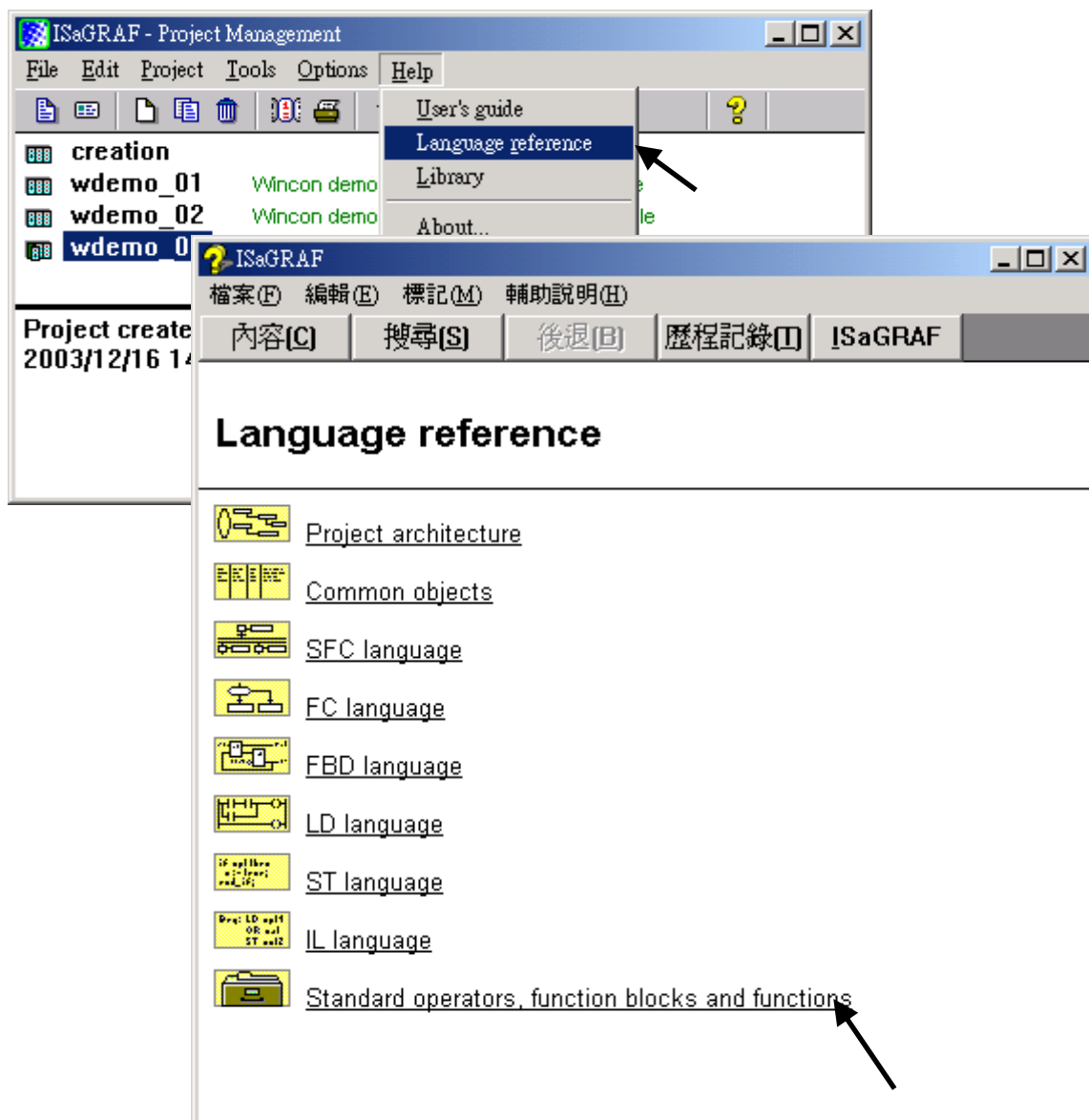

On-line help of ICP DAS add-on functions & function blocks:

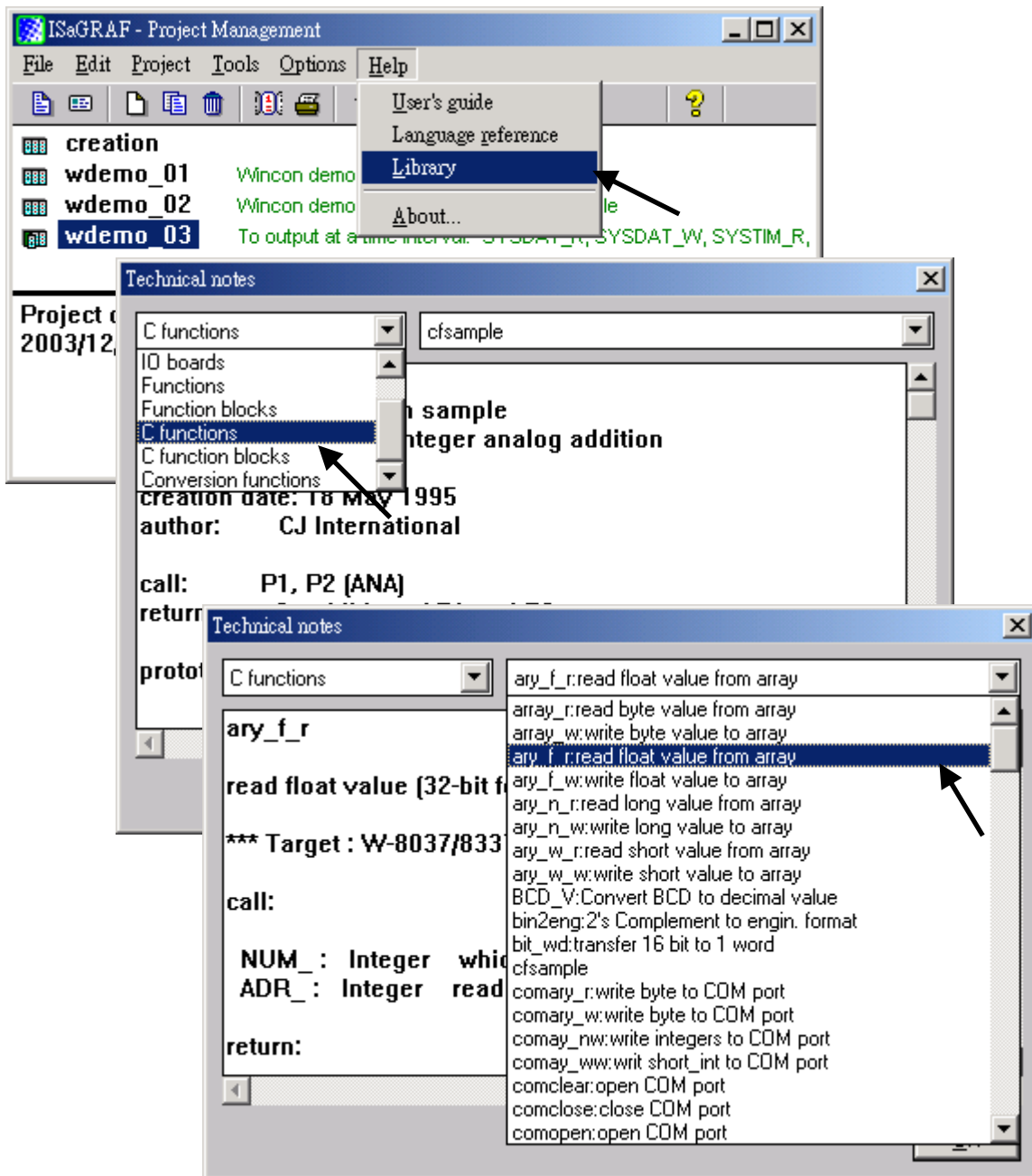

On-line help of ICP DAS add-on I/O boards & I/O complex equipments:

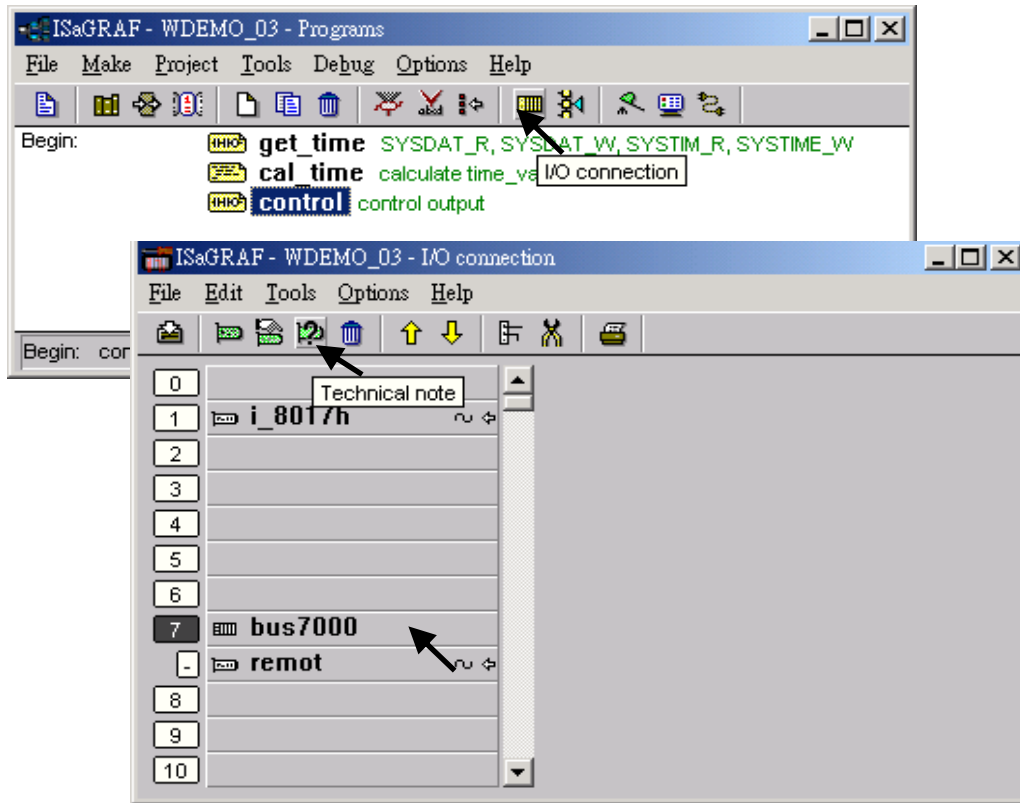

On-line help of ISaGRAF languages:

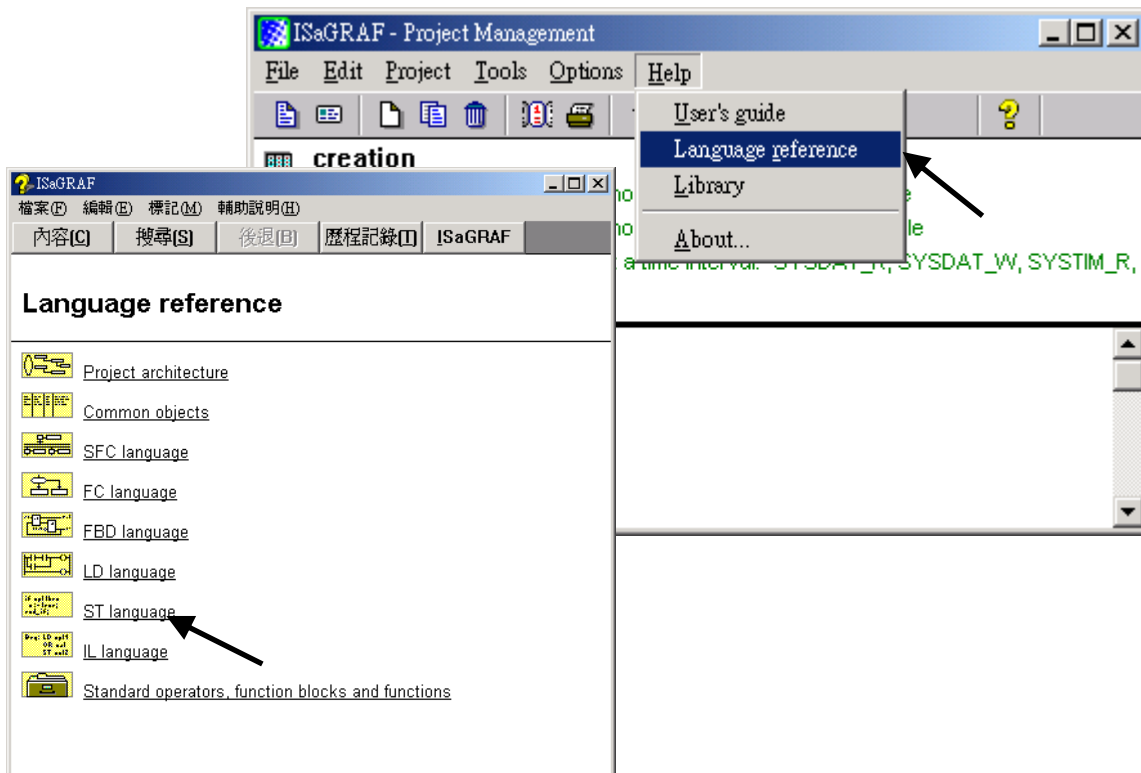

9.2 Installing The ISaGRAF Programming Examples

The ISaGRAF programming examples:

http://www.icpdas.com/products/PAC/i-8000/isagraf_demo_list.htm
XP-8xx7-CE6 CD-ROM: [\napdos\isagraf\xp-8xx7-ce6\demo\](#)

ISaGRAF User's Manual:

http://www.icpdas.com/products/PAC/i-8000/getting_started_manual.htm
English: [\napdos\isagraf\wp-8xx7\english-manu\](#)
"User_Manual_I_8xx7.pdf"
"User_Manual_I_8xx7_Appendix.pdf"

XP-8xx7-CE6 Demo Example Files:

http://www.icpdas.com/products/PAC/i-8000/isagraf_demo_list.htm
<ftp://ftp.icpdas.com/pub/cd/xp-8xx7-ce6/napdos/isagraf/xp-8xx7-ce6/demo/>

ISaGRAF FAQ:

www.icpdas.com > FAQ > Software > ISaGRAF V.3 (English)
<http://www.icpdas.com/faq/isagraf.htm>

Example lists:

Project Name	Description	I/O Boards Used
sofgr_01	A simple Soft-GRAF HMI demo. (sofgr_01~sofgr_08: FAQ-131)	
sofgr_02	A Soft-GRAF demo which use 18 HMI objects.	
sofgr_03	A Soft-GRAF demo. Display 10 temperature values and 8 D/I values and control 8 D/O. Data amount less than 255.	
sofgr_04	A Soft-GRAF demo. Read process parameters from a file or store them. Data format is Float data, only handle one file. Data amount less than 255.	
sofgr_05	A Soft-GRAF demo. Read process parameters from a file or store them. Data format is Integer data, only handle one file. Data amount less than 255.	
sofgr_06	A Soft-GRAF demo. Read process parameters from a file or store them. Data format is Float data, handle several files. Data amount less than 255.	
sofgr_07	A Soft-GRAF demo. Read process parameters from a file or store them. Data format is Integer data, handle several files. Data amount: 1000 (can be more).	
sofgr_08	A Soft-GRAF demo. Read process parameters from a file or store them. Data format is Float data, handle several files. Data amount: 1000 (can be more).	

Project Name	Description	I/O Boards Used
example1	A simple Web HMI example	slot 1: I-87055W
wp_vb01	VB.net 2008 demo 01 : Digital I/O demo. Please refer to Chapter 6 .	slot 1: I-87055W
wp_vb02	VB.net 2008 demo 02 : Analog I/O demo. Please refer to Chapter 6 .	slot 1: I-87024W slot 2: I-8017HW
wp_vb03	VB.net 2008 demo 03 : Read / Write long integer, float & Timer. Please refer to Chapter 6 .	
xpdmo_01	XPAC demo_01: R/W float value from file (www.icpdas.com > FAQ > Software > ISaGRAF > 060)	
xpdmo_02	XPAC demo_02: R/W long integer from file (www.icpdas.com > FAQ > Software > ISaGRAF > 060)	
xpdmo_03	To output at a time interval: SYSDAT_R, SYSDAT_W, SYSTIM_R, SYSTIM_W (ST+QLD)	
xpdmo_04	XPAC demo_04: User defined Modbus protocol (No using "Mbus")	
xpdmo_05	To do something at some sec later when an event happens (www.icpdas.com > FAQ > Software > ISaGRAF > 17)	slot 1: I-87055W
xpdmo_06	Using Message Array - MsgAry_r , MsgAry_w	
xpdmo_07	Convert float value to string, using real_str & rea_str2	
xpdmo_08	PID control, refer to XP-8xx7-CE6 CD: \napdos\isgraf\xp-8xx7-ce6\english-manu\PID_AL...htm "	
xpdmo_09	Store & backup boolean & long integer value To/From files	
xpdmo_10	Store & backup boolean & long integer value To/From EEPROM	
xpdmo_11	Dir is \Micro_SD ,save 3 values to 3 files per 10 minutes ,change file name per month	
xpdmo_14	Retain variable by Retain_b, Retain_N, Retain_f, Retain_t (www.icpdas.com > FAQ > Software > ISaGRAF > 74)	
xpdmo_16	Dir is \Micro_SD ,save 3 values to 1 file every minute ,change file name every day	
xpdmo19	Send UDP String to PC when alarm happens (using variable array),Time_Gap is 1 sec (Chapter 19.2 of the "ISaGRAF User's Manual")	Slot1: I-87055W
xpdmo19a	Send UDP String to PC 3 sec later, Time_Gap is 250ms (Chapter 19.2 of the "ISaGRAF User's Manual")	Slot1: I-87055W
xpdmo19b	Send UDP Str to PC 3 sec later (xpdmo19a is better), Time_Gap is 250 ms (Chapter 19.2 of the "ISaGRAF User's Manual")	Slot1: I-87055W
xpdmo_20	receive String coming from remote PC or controller via UDP/IP	
xpdmo_21	using "com_MRTU" to disable/enable Modbus RTU slave port,	

Project Name	Description	I/O Boards Used
xpdmo_22	PWM I/O demo. (Pulse Width Modulation), minimum scale is 2ms for WinPAC	Slot1: I-8055W
xpdmo_23	Send Time String to COM3:RS-232 every second by using COMOPEN, COMSTR_W (www.icpdas.com > FAQ > Software > ISaGRAF > 59)	
xpdmo_24	Send string to COM3 when alarm 1 to 8 happens	Slot1: I-87055W
xpdmo_26	To move some pulse at x-axis of I-8091W of slot 1 in XPAC (Chapter 18 of the "ISaGRAF User's Manual")	slot 1: I-8091W
xpdmo_27	Motion x (Chapter 18 of the "ISaGRAF User's Manual")	slot 1: I-8091W slot 2: I-8090W
xpdmo_28	Motion x-y (Chapter 18 of the "ISaGRAF User's Manual")	slot 1: I-8091W slot 2: I-8090W
xpdmo_29	Moving to the Abs. position when CMD is given (Chapter 18 of the "ISaGRAF User's Manual")	slot 1: I-8091W slot 2: I-8090W
xpdmo_30	XPAC(10.0.0.102) link two I-8KE8 + I/O , one is 10.0.0.108, one is 10.0.0.109 (www.icpdas.com > FAQ > Software > ISaGRAF > 42)	
xpdmo_31	XPAC(10.0.0.2) link one I-8KE8 + I/O (10.0.0.109) (www.icpdas.com > FAQ > Software > ISaGRAF > 42)	
xpdmo_32	Set up XPAC as TCP/IP Client & link to other TCP/IP server (1 connection) (Chapter 19.3 of the "ISaGRAF User's Manual")	slot 1: I-87055W
xpdmo_33	Same as xpdmo_32 but send message only when event last for larger than 3 seconds	slot 1: I-87055W
xpdmo_36	Read Real Val from Modbus RTU device (www.icpdas.com > FAQ > Software > ISaGRAF > 47 & 75)	
xpdmo_37	Write Real Val to Modbus RTU device (www.icpdas.com > FAQ > Software > ISaGRAF > 47 & 75)	
xpdmo_38	Using Modbus function code 6 to write 16 bits (www.icpdas.com > FAQ > Software > ISaGRAF > 46 & 75)	
xpdmo_39	XP-8xx7-CE6 + I-8172W connecting FRNET I/O modules (www.icpdas.com > FAQ > Software > ISaGRAF > 82)	
xpdmo_41	COM3 connecting 1:M7053D + 2:M7045D (MBRTU format, baud=9600) (Chapter 21 of the "ISaGRAF User's Manual")	
xpdmo_42	COM3 connecting 1:M-7053D to get DI counter value (MBRTU format, baud=9600)	
xpdmo_43	COM3 connecting 1:M7017R + 2:M7024 (MBRTU format, baud=9600)	
xpdmo_44	COM3 connecting 1:M7017RC , Current input, +/- 20mA, 4-20mA (Modbus format)	
xpdmo_45	COM3 connecting 1:M-7019R (set as T/C K-type input) (MBRTU format, baud=9600)	
xpdmo_46	COM3 connecting 1:M7080 (MBRTU format, baud=9600)	

Project Name	Description	I/O Boards Used
xpdmo_48	VB.net 2005 demo - "MBTCP_demo" (www.icpdas.com > FAQ > Software > ISaGRAF > 51)	
xpdmo_50	Non-linear conversion. like give P to find V (P , V relation listed in a file)	
xpdmo_51	Read 10 REAL value from a file,10 rows,each row has 1 REAL value, use str_real	
xpdmo_52	Msg_F. I-8xx7 since v3.19. I-7188EG/XG since 2.17/2.15. W-8xx7 since 3.36, XP/WP-8xx7	
xpdmo_53	Msg_N. I-8xx7 since v3.19. I-7188EG/XG since 2.17/2.15. W-8xx7 since 3.36, XP/WP-8xx7	
xpdmo_54	Read 20 REAL values from a file,4 rows,each row has 5 REAL values,uses msg_f (www.icpdas.com > FAQ > Software > ISaGRAF > 60)	
xpdmo_55	Read 20 Integers from a file,2 rows, each row has 10 Integers,uses msg_n	
xpdmo56	Retain 17 REAL value in a file, 2 rows, Each row has 10 REAL values.	
xpdmo56a	Retain 2 Boo + 17 REAL in a file, 2 rows, Each row has 10 REAL values.	
xpdmo56b	Retain 25 Integer in a file, 2 rows, Each row has 10 integer values.	
xpdmo56c	Retain 2 Boo + 25 Integer in a file, 2 rows, Each row has 10 integer values. (www.icpdas.com > FAQ > Software > ISaGRAF > 60)	
xpdmo56d	Retain 17 Real + 2 Boo + 10 Integers in 2 files, Each row has 10 values.	
xpdmo56e	Retain more than 255 Real, 255 Boo, 255 Integer in 2 files, up to 1024.	
xpdmo_61	AutoReport data to PC via UDP. Controller=10.0.0.103, PC=10.0.0.91	
xpdmo_62	Send email via Ethernet port. (To one receiver without attached file) (www.icpdas.com > FAQ > Software > ISaGRAF > 67 , 71, 72, 76 or 77)	
xpdmo_63	Send email to one receiver with one attached file. (www.icpdas.com > FAQ > Software > ISaGRAF > 67 , 71, 72, 76 or 77)	
xpdmo64a	station 1001 , Time synchronization of many controllers via Ethernet.	
xpdmo64b	station 1002 , Time synchronization of many controllers via Ethernet.	
xpdmo65a	Record temperature per minute to a file. Then send it by email per day (www.icpdas.com > FAQ > Software > ISaGRAF > 67 , 71, 72, 76 or 77)	slot 2: I-87018z
xpdmo65b	Same as xpdmo_65a but add time synchronization and state report to PC (www.icpdas.com > FAQ > Software > ISaGRAF > 67 , 71, 72, 76 or 77)	slot 2: I-87018z

Project Name	Description	I/O Boards Used
xpdmo_66	Record 1 to 4-Ch. I-8017HW voltage pe 20ms, then send this record file by Email	slot 2: I-8024W slot 3: I-8017HW
xpdmo_70	FRnet : slot1: I-8172W, Port0, FR-2057(adr=4), FR-2053(adr=8)	slot 1: I-8172W FR-2057 FR-2053
xpdmo71a	COM4 connects I-7530 -- "CANopen" ID=1 device (8DI, 8DO, 4AO, 8AI) (www.icpdas.com > FAQ > Software > ISaGRAF > 86)	
xpdmo71c	COM4 – 7530 -- CAN device to get string (with float or integer data inside)	
xpdmo72a	New redundant system with RU-87P4 + I-87K I/O (Without Touch HMI) (www.icpdas.com > FAQ > Software > ISaGRAF > 93)	
xpdmo72b	Same as xpdmo72a but setup COM1 as Modbus RTU slave port to connect one RS-232 Touch HMI (www.icpdas.com > FAQ > Software > ISaGRAF > 93)	
xpdmo72c	New redundant system with I-8KE8-MTCP I/O (Without Touch HMI)	
xpdmo72d	New redundant system without I-7000 or I-87K I/O or I-8KE8-MTCP I/O	
xpdmo74a	get average value of one REAL value (www.icpdas.com > FAQ > Software > ISaGRAF > 99)	
xpdmo74b	get average value of one Integer value (www.icpdas.com > FAQ > Software > ISaGRAF > 99)	
xpdmo75	Using the I-8088W(8-ch, PWM output) in slot1	slot 1: I-8088W
xpdmo75a	using the I-87088W in slot 2	slot 2: I-87088W
xpdmo75b	Connect the I-87088W (I-7088) (addr=1,baud=115200) via XP-8xx7-CE6's COM3:RS485	I-87088W (I-7088)
xpdmo_76	SMS : XPAC, COM4: GTM-201-RS232	GTM-201-RS232
xpdmo77a	sending / Receiving UDP bytes by using eth_udp and eth_send() and eth_recv()	
xpdmo77b	sending / Receiving TCP bytes by using eth_tcp and eth_send() and eth_recv()	
xpdmo78	XP-8xx7-CE6 COM3 Mbus Master---M-7011 (ID=1, baud=9600) to get AI,DI (FAQ-118)	M-7011
xpdmo80a	AP2 of FAQ119: Mbus TCP Master (Central station)	
xpdmo80b	AP2 of FAQ119 (local 1),Must set ID to 1,LAN1=192.168.1.178, LAN2=192.168.1.179	
xpdmo80c	AP2 of FAQ119 (local 2),Must set ID to 1,LAN1=192.168.1.180, LAN2=192.168.1.181	
xpdmo81a	XP-8xx7-CE6 redundant system --- iDCS-8000	iDCS-8000
xpdmo81b	XP-8xx7-CE6 redundant system --- iDCS-8000 (& COM6 --- i-7055D "addr=1,9600")	iDCS-8000

Project Name	Description	I/O Boards Used
xphmi_01	XP-8xx7-CE6 Web HMI example 1 , Display controller's date & time (No I/O board)	
xphmi_02	XP-8xx7-CE6 Web HMI example 2 , DI & DO demo (slot 1: I-87055W)	slot 1: I-87055W
xphmi_03	XP-8xx7-CE6 Web HMI example 3 , R/W Long, float & Timer value (No I/O board)	
xphmi_04	XP-8xx7-CE6 Web HMI example 4 , R/W controller's String (No I/O board)	
xphmi_05	XP-8xx7-ce6 Web HMI example 5,Multi-Page dmo, slot 1:87055W,Menu is on the Left	slot 1: I-87055W
xphmi05a	XP-8xx7-ce6 Web HMI example 5A, Multi-Page demo,slot 1:87055W,Menu is on the top	slot 1: I-87055W
xphmi_06	XP-8xx7-CE6 Web HMI ex. 6,AIO dmo,slot 2:87024W, slot 3:8017HW,scaling is in ISaGRAF	slot 2: I-87024W slot 3: I-8017HW
xphmi_07	XP-8xx7-CE6 Web HMI ex. 7, AIO dmo, slot 2: i87024W, 3:8017HW, scaling is in PC	slot 2: I-87024W slot 3: I-8017HW,
xphmi_08	XP-8xx7-CE6 Web HMI ex. 8, download controller's file to PC (slot 1: I-87055W)	slot 1: I-87055W
xphmi_09	XP-8xx7-CE6 Web HMI ex. 9, pop up an alarm window on PC (slot 1: I-87055W)	slot 1: I-87055W
xphmi_11	trend curve demo (slot 2: I-87024W , slot 3: I-8017HW)	slot 2: I-87024W slot 3: I-8017HW
xphmi_12	Record 1 to 8 Ch. I-8017HW 's volt every 50ms and draw trend curve by M.S.Excel	I-8017HW
xphmi_13	Record 1 to 4-Ch. I-8017H's voltage every 10ms and draw trend curve by M.S.Excel	I-8017HW

Install the ISaGRAF example programs

When you install the ISaGRAF programming example for the ISaGRAF PAC, it is recommended that you create an "ISaGRAF Project Group" to install the demo program files into it.

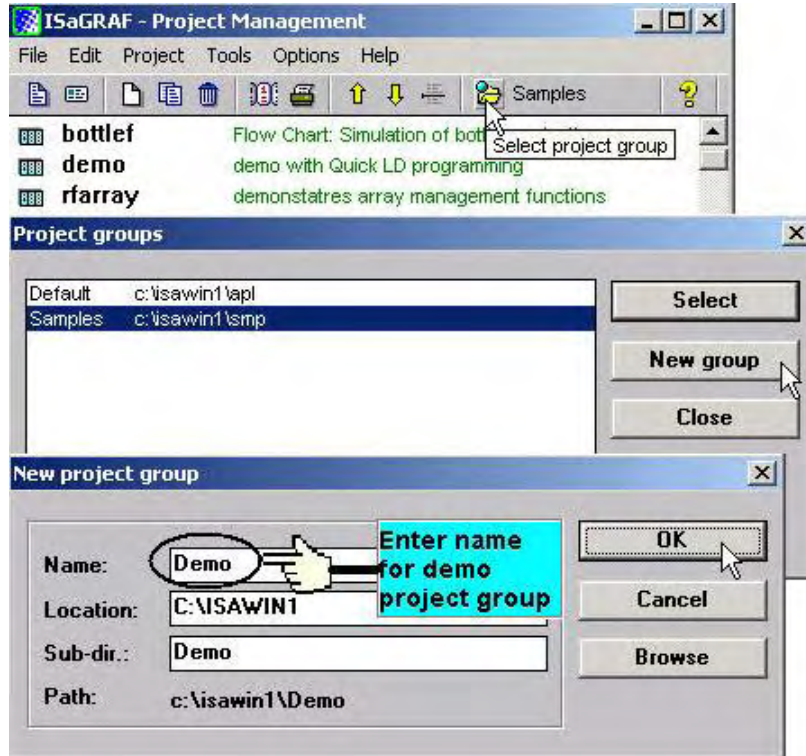

To install the demo programs into the project you have created open the "ISaGRAF Project Management" window to select "Tools" from the menu bar, then select the "Archive" option and then click on "Projects".

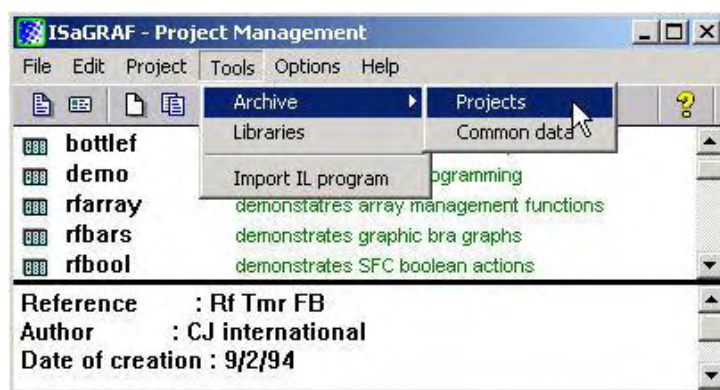

When you click on the "Projects" selection the "Archive Projects" window will open. Click on the "Browse" button to select the drive and the sub-directory where the demo files are located ([\napdos\isagraf\xp-8xx7-ce6\demo\](#) in the XP-8xx7-CE6 CD-ROM) .

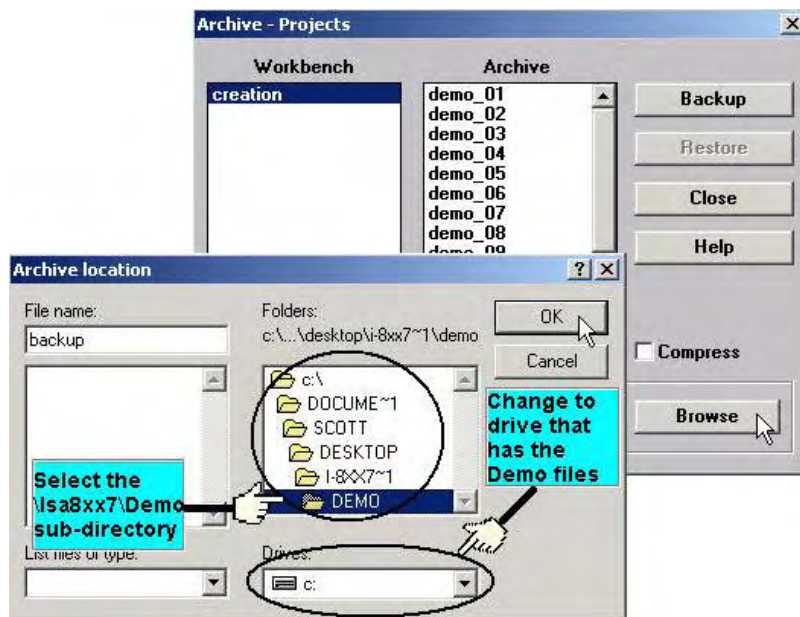

To install all of the Demo files, click on the "xpdmo_01" file, then press and hold down the "Shift" key, continue to hold down the "Shift" key and use your mouse to scroll down to last file in the "Archive" window. Click on the last file name from the demo file location and that will select the entire group of demo files. Lastly, click on the "Restore" button in the "Archive Projects" window and all of demo files will be installed into the sub-directory you have created.

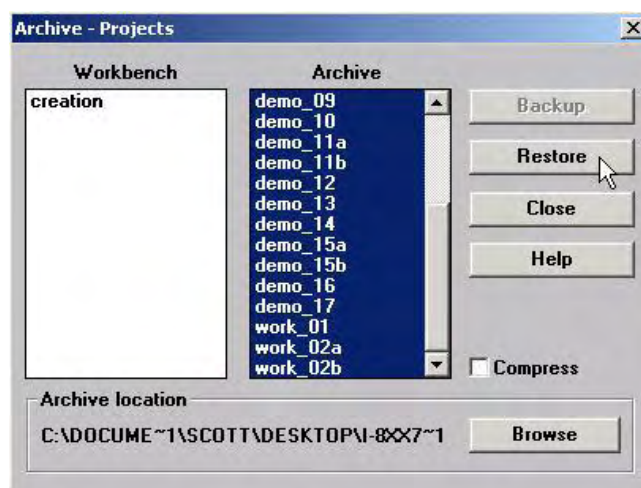

9.3 Frequently Asked Questions

ISaGRAF frequently asked questions (FAQ) website direction:

FAQ (ISaGRAF Ver.3 FAQ: Questions/Descriptions/Demo programs)

<http://www.icpdas.com/faq/isagraf.htm>

www.icpdass.com > FAQ > Software > ISaGRAF Ver.3 (English)

FAQ Table:

No.	English ISaGRAF Ver.3 FAQ
001	Q: How to get counter value built in I-7000 & I-87xxx remote I/O modules?
002	Q: How to search I/O boards and declare variables automatically for I-8xx7 controllers?
003	Q: How to build a HMI screen by using ISaGRAF?
004	Q: Can I create my own functions inside ISaGRAF?
005	Q: Can I use more than 32 I/O in my ISaGRAF project if I don't have ISaGRAF-256 or ISaGRAF-L?
006	Q: Can I use ISaGRAF controller (I-8417/8817/8437/8837, I-7188EG/XG) as a Modbus Master controller to gather data from other Modbus devices?
007	Q: Can I write my own protocol or third-party protocol to apply on ISaGRAF controllers?
008	Q: What is the limitation of program size of I-8417/8817/8437/8837, I-7188EG & I-7188XG?
009	Q: Can not find I/O boards in the ISaGRAF I/O connection window?
010	Q: I Want to email my ISaGRAF program to someone. How can I archive one ISaGRAF project to a single file?
011	Q: How can I implement motion control in I-8417/8817/8437/8837?
012	Q: My HMI software wants to access to float values and long word values inside the I-8417/8817/8437/8837, 7188EG & 7188XG. How?
013	Q: PWM: Can I generate D/O square pulse up to 500Hz with I-8417/8817/8437/8837, 7188EG & 7188XG controllers? How?
014	Q: Can I use 8K Parallel D/I board to get counter Input up to 500Hz? How ?
015	Q: How to output something at a time interval? For ex. Turn ON at 09:00~18:00 on Monday to Saturday , while 13:00~20:00 on Sunday.
016	Q: How to determine a DI if it has bouncing problem?
017	Q: How to trigger something at some seconds later when one event happens?
018	Q: Does the ISaGRAF-256 software have I/O Tag limitation? Why not using "ISaGRAF-L" Large version?
019	Q: Why my I-8417/8817/8437/8837 or I-7188EG/XG stop running?
020	Q: How to search a variable name in an ISaGRAF project?
021	Q: When closing my ISaGRAF window, it holds for long time. Why?
022	Q: How to use Proface HMI (Touch panel) to link to I-7188EG/XG, I-8xx7 and WinCon-8x37?
023	Q: How to reduce ISaGRAF code size? How to directly Read / Write ISaGRAF variables by using Network address?
024	Q: How to scale Analog Input and Output of 4 to 20 mA to my engineering format?

No.	English ISaGRAF Ver.3 FAQ
	How to scale Analog Input and Output of 0 to 10 V to my engineering format?
025	Q: How to detect controller Fault?
026	Q: New ISaGRAF retained variable is better than old one.
027	Q: How to link to Modbus ASCII Slave device?
028	Q: How to use multi-port Modbus Master in the WinCon-8037/8337/8737 & WinCon-8036/8336/8736?
029	Q: How to send/receive message from ISaGRAF PAC to remote PCs or Controllers via Ethernet UDP communication?
030	Q: Setting special "range" parameter of temperature input board to get clear "Degree Celsius" or "Degree Fahrenheit" input value. For ex, "1535" means 15.35 degree.
031	Q: Setting a special "ADR_" parameter of remote I-7000 & I-87K temperature input module to get clear "Degree Celsius" or "Degree Fahrenheit" input value. For ex, "8754" means 87.54 degree.
032	Q: How to access to ISaGRAF variables as array? (A demo program of sending string to COM2 or COM3 when alarm 1 to 8 happens)
033	Q: Setting up more Modbus RTU Slave ports in WinCon ISaGRAF PACs.
034	Q: Compiling error result in different ISaGRAF version?
035	Q: Slow down ISaGRAF driver speed to work better with InduSoft software in W-8036/8336/8736 & W-8046/8346/8746?
036	Q: Redundancy Solution in WinCon-8xx7.
037	Q: I-7188EG/XG support remotely downloads via Modem Link.
038	Q: Setting I-7188EG/XG's COM3 as Modbus RTU Slave port.
039	Q: ISaGRAF version 3.4 & 3.5 now supporting "Variable Array" !!!
040	Q: Setting I-8437/I-8837/I-8437-80/I-8837-80's COM3 as Modbus RTU Slave port.
041	Q: How to connect PC / HMI to a Redundancy system with a single IP address?
042	Q: How to use WinCon connecting to Ethernet I/O? The I/O scan rate is about 30 to 40 msec for 3000 to 6000 I/O channels.
043	Q: How to setup WinCon-8xx7 as TCP/IP Client to communicate to PC or other TCP/IP Server device? Or WinCon automatically report data to PC via TCP/IP?
044	Q: WinCon-8xx7/8xx6 automatically report data to PC/InduSoft or PC/HMI?
045	Q: ISaGRAF controllers display message to EKAN Modview LED.
046	Q: How to Write 16-bits to Modbus RTU devices by Modbus function call No. 6?
047	Q: How to Read or Write Floating Point value to Modbus RTU Slave device?
048	Q: How to use WinCon-8xx7 / 8xx6 to control FRnet I/O?
049	Q: Setting a special "CODE_" parameter of "MBUS_R" & "MBUS_R1" to get a clear "Degree Celsius" or "Degree Fahrenheit" input value of M-7000 temperature module. For ex, "3012" means 30.12 degree.
050	Q: How to connect an ISaGRAF controller to M-7000 Remote I/O?
051	Q: VB.net 2005 Demo program using Modbus TCP/IP protocol to control ISaGRAF PACs
052	Q: VB 6.0 Demo program using Modbus TCP/IP protocol to control ISaGRAF PACs.
053	Q: Performance Comparison Table of ISaGRAF PACs.

No.	English ISaGRAF Ver.3 FAQ
054	Q: iPAC-8xx7 and μ PAC-7186EG support Data Logger function.
055	Q: How to connect I-7018z to get 6 channels of 4 to 20 mA Input and 4 channels of Thermo-couple temperature Input? And also display the value on PC by VB 6.0 program?
056	Q: How to do periodic operation in ISaGRAF PACs?
057	Q: How to record I-8017H's Ch.1 to Ch.4 voltage Input in a user allocated RAM memory in the WinCon-8xx7? The sampling time is one record every 0.01 second. The record period is 1 to 10 minutes. Then PC can download this record and display it as a trend curve diagram by M.S. Excel.
058	Q: How to record I-8017H's Ch.1 to Ch.4 voltage input in S256 / 512 in I-8437-80 or I-8837-80? The sampling time is one record every 0.05 second. The record period is 1 to 10 minutes. Then PC can download this record and display it as a trend curve diagram by M.S. Excel.
059	Q: Some skill to operate RS-232/422/485 serial COM Port by COM functions
060	Q: How to read / write file data in WinCon?
061	Q: How to connect RS-485 Remote I-7000 and I-87K I/O modules in I-8xx7, I-7188EG/XG and WinCon-8xx7 PAC? How to program RS-485 remote I-7017RC, I-87017RC and I-7018Z?
062	Q: How to setup a redundant system with Ethernet I/O?
063	Q: Why my RS-485 remote I-7000 and I-87K Output module's host watchdog function doesn't work to reset its output channels to safe output value while the RS-485 communication cable is broken?
065	Q: ICP DAS release Stable and Cost-effective Data Acquisition Auto-Report System. (VC++ 6.0, VB 6.0 and ISaGRAF demo program are available)
066	Q: How to process the Integer or Real value coming from the RS-232 / RS-485 device? Like the device of Bar-Code reader or RS-232 weight meter.
067	Q: How to send email with one attached file by WinCon-8xx7 or iPAC-8447 / 8847 or μ PAC-7186EG?
068	Q: Why the W-8xx7 or I-8xx7 or I-7188EG/XG always reset? How to fix it?
069	Q: Why my PC can not run "ftp" to connect W-8347 or W-8747?
070	Q: How to do Time Synchronization and record state of many ISaGRAF PACs?
071	Q: Application: Record 10-Ch. temperature value into a file in W-8xx7 every minute. When 24 hour recording is finished, send this record file by email every day.
072	Q: Application sample: Record Voltage / Current input by W-8xx7 every 20 ms for 1 to 10 minutes. Then send this record file by email.
073	Q: Why does the I-7017 or I-87017's Current Input reading value become double or incorrect?
074	Q: How to use ISaGRAF new Retain Variable? What is its advantage?
075	Q: Why my ISaGRAF project can not connect Modbus Slave device correctly?
077	Q: Application sample: Record Voltage / Current input by μ PAC-7186EG every second for 1 to 10 minutes. Then send this record file by email.
080	Q: Application: Record 10-Ch. temperature value into a file in μ PAC-7186EG every minute. When 24 hour recording is finished, send this record file by email every day.
081	Q: How to measure +/-150VDC in ISaGRAF controllers plus the I-87017W-A5 I/O card?

No.	English ISaGRAF Ver.3 FAQ
082	Q: An easy way to program the fast FRnet remote I/O modules.
083	Q: How to set I-8x37, I-8x37-80, I-7188EG and μPAC-7186EG's TCP recycling time?
084	Q: Application: A Cost Effective and Hot-Swap Redundancy System by μPAC-7186EG or I-8437-80 plus RU-87P4/8.
086	Q: The WinCon-8347 / 8747 , μPAC-7186EG and iP-8447 / 8847 connecting one or several I-7530 to link many CAN or CANopen devices and sensors.
087	Q: What does it mean and how to fix it when the 7-segment LED shows error messages of Err00, Err02, Err03, Err90 or E.0001 after booting the PAC?
088	Q: Function Modifications: The W-8347/8747, μPAC-7186EG, I-8x37-80, I-8xx7 and I-7188EG/XG with S256/512 and X607/608 no longer support old retain method, please change to use the better new retain method to retain variables.
089	Q: Why my μPAC-7186EG unable to renew the driver and ISaGRAF application?
090	Q: How to use I-7017Z module in ISaGRAF PAC?
091	Q: How to use ISaGRAF PAC plus I-87089-the VW sensor Master card to measure the Vibration Wire frequency to calculate the stress of constructions?
092	Q: Setting μPAC-7186EG's and I-7188EG/XG's COM3 or COM2 as Modbus RTU Slave port.
093	Q: New Hot-Swap and Redundant solution for the WinCon-8347 / 8747.
094	Q: How to update the WinCon-8347/8747's OS?
095	Q: The WinCon-8xx7 supports Max. 32 Modbus TCP/IP connections since Its Driver version 4.03.
096	Q: Release two C-Function-Blocks to read max. 24 Words or 384 Bits from Modbus RTU / ASCII devices.
097	Q: How to modify the IP, NET-ID and Modbus RTU Slave port setting of the W-8347 / 8747 by an USB pen drive (without Mouse and VGA)?
098	Q: Application: Link Serial COM Port to the Modbus RTU device by COM functions .
099	Q: How to get an average value of a Real or Integer variable which is sampled every fixed interval (or sampled in every PLC scan) ?
100	Q: How to use I-8084W (4 / 8 – Ch. Counter or 8-Ch. frequency) ?
101	Q: How to read max. 120 Words or max. 60 Long-Integers or max. 60 Real value from Modbus RTU / ASCII devices by using MBUS_XR or MBUS_XR1 function block (for WP-8xx7 / 8xx6 and VP-25W7/23W7/25W6/23W6 and Wincon-8xx7 / 8xx6 only) ?
102	Q: Why PC can not connect the WP-8xx7 or VP-25W7/23W7 's FTP server ?
103	Q: Using RS-232 Or USB Touch Monitor With WinPAC.
104	Q: Why my PC running ISaGRAF can not connect the ISaGRAF PAC correctly ?
105	Q: Program The 8-Channel PWM Output Board : I-8088W In WP-8xx7, VP-25W7/23W7 And iP-8xx7 PAC.
106	Q: How to display the frequency trend curve by running ISaGRAF and C# .net 2008 program in the WinPAC-8xx7 plus I-8084W?
107	Q: How to do auto-time-synchronization and measure the local Longitude and Latitude by using the i-87211W GPS I/O module in ISaGRAF PAC ?
108	Q: How to display the temperature trend curve by running ISaGRAF and C# .net 2008 program in the WinPAC-8xx7 plus i-87018z?
109	Q: How to adjust the system time of some ISaGRAF PACs via Ebus by using ISaGRAF PAC and I-87211w?

No.	English ISaGRAF Ver.3 FAQ
110	Q: ZigBee Wireless Application: How to control remote I/O and acquire data?
111	Q: How to use the GTM-201-RS232 to send a short message in user's local language ?
112	Q: Program the I-8093W (3-axis high speed Encoder input module) by ISaGRAF.
113	Q: Linking ISaGRAF PAC to Modbus TCP/IP Slave Devices By Modbus TCP Master Protocol.
114	Q: How to avoid garbled content when printing ISaGRAF PDF documents?
115	Q: Working eLogger HMI with ISaGRAF SoftLogic in the WP-8xx7, VP-2xW7 and XP-8xx7-CE6 PAC. (the document version is 1.03 released on Jul.15,2010)
116	Q: How to enable the second to fifth Modbus RTU slave port of the WP-8xx7 and VP-2xW7 without modifying the ISaGRAF project ?
117	Q: How to install the ISaGRAF Ver. 3 on Windows Vista or Windows 7?
118	Q: A M.S. VC++ 6.0 Demo Program To Connect One WP-8xx7 by Modbus TCP Protocol.
119	Q: How to implement the communication redundancy between the central control station and the local stations?
120	Q: How to calculate the moving average value of a variable by c-functions "Aver_N" or "Aver_F" ?
121	Q: How to install or remove the ISaGRAF development platform properly?
122	Q: How To Solve The USB-Freeze Problem Of The W-8x4x ? How To Update The W-8x4x 's OS Image ?
123	Q: How to move the InduSoft picture faster in the W-8xx6 / WP-8xx6 / VP-25W6 / XP-8xx6-CE6 ?
124	Q: A Web HMI Example for ISaGRAF Professional XPAC XP-8xx7-CE6-PRO – by FrontPage .
125	Q: XP-8xx7-CE6 And iDCS-8000 (Or ET-7000 Or Modbus TCP Slave device) Redundant System.
126	Q: How to use the WP-8847 to connect ET-7018Z and ET-7044D and develop the HMI program by InduSoft, VS2008 C# and VB.NET ?
128	Q: How to use The ISaGRAF PAC plus i-87113DW - the master card of the Carlson Strain Gauage Inputs ?
129	Q: How To Connect The ICP DAS Power Meter – PM-2133 and PM-2134 By The ISaGRAF PAC ?
130	Q: How to automatically synchronize the time of WP-8x47/VP-23W7 over a network ?
131	Q: Soft-GRAF : Create A Colorful HMI in The XP-8xx7-CE6 and WP-8xx7 and VP-2xW7 PAC (paper version: 1.3) .
132	Q: Motion Control - Using I-8094F/8092F/8094

Chapter 10 C# .net 2008 Program Running In The XP-8xx7-CE6 Access To ISaGRAF Variables

This chapter lists the procedure for creating the first demo program by Visual Studio .NET 2008 development tool. There is some sample programs in the XP-8xx7-CE6 CD-ROM.

XP-8xx7-CE6 CD-ROM :

[\napdos\isagraf\xp-8xx7-ce6\xpce6-CSharp.net-2008-demo\](#)

wp_CSharp01 : Digital I/O demo with one I-87055W in slot 1 of the XP-8xx7-CE6.

wp_CSharp02 : Analog I/O demo with one I-87024W in slot 2 and one I-8017HW in slot 3.

wp_CSharp03 : Read / Write ISaGRAF internal integers, timers and real variables.
(No I/O)

The related ISaGRAF demo project name are "wp_vb01.pia" , "wp_vb02.pia" and "wp_vb03.pia" in the same directory.

10.1 Create a New Project

1. In the first, users need to open Microsoft Visual Studio .NET 2008 software. And then in the menu of “**File**”, please run the “**New Project**” .

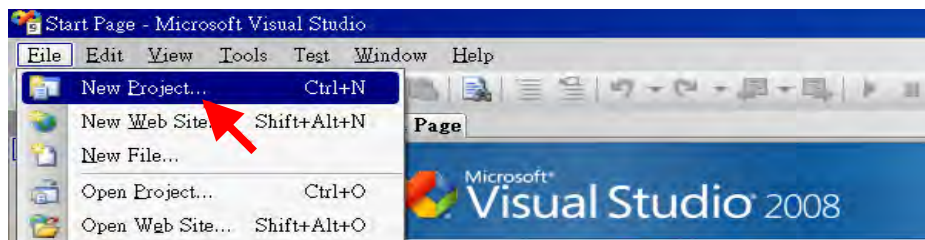

2. Check the “Smart Device” on the left, then selecting the “.NET frame work 3.5” and “Smart Device Project”. Then entering a proper project name and the last click on “OK” .

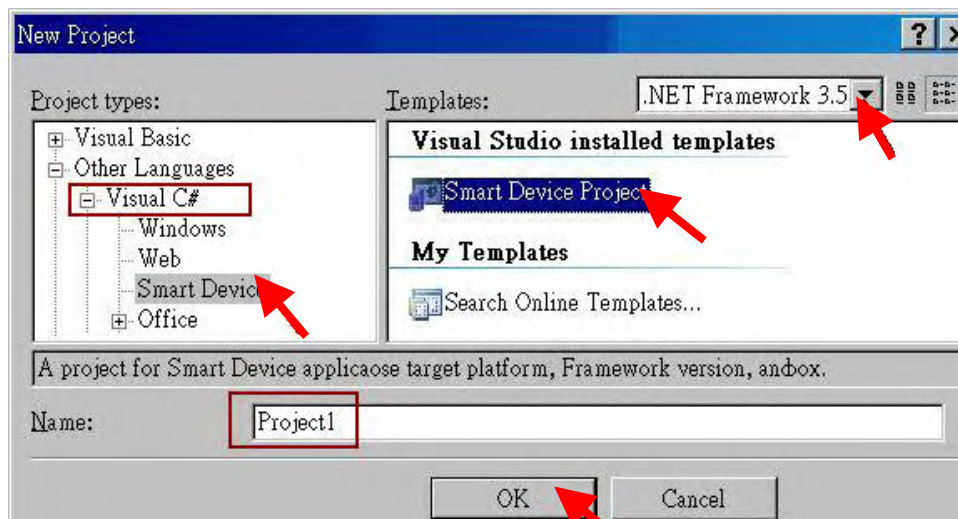

3. Select the "Device Application" and "Windows CE" and ".NET Compact Framework Version 3.5" , then click on "OK" .

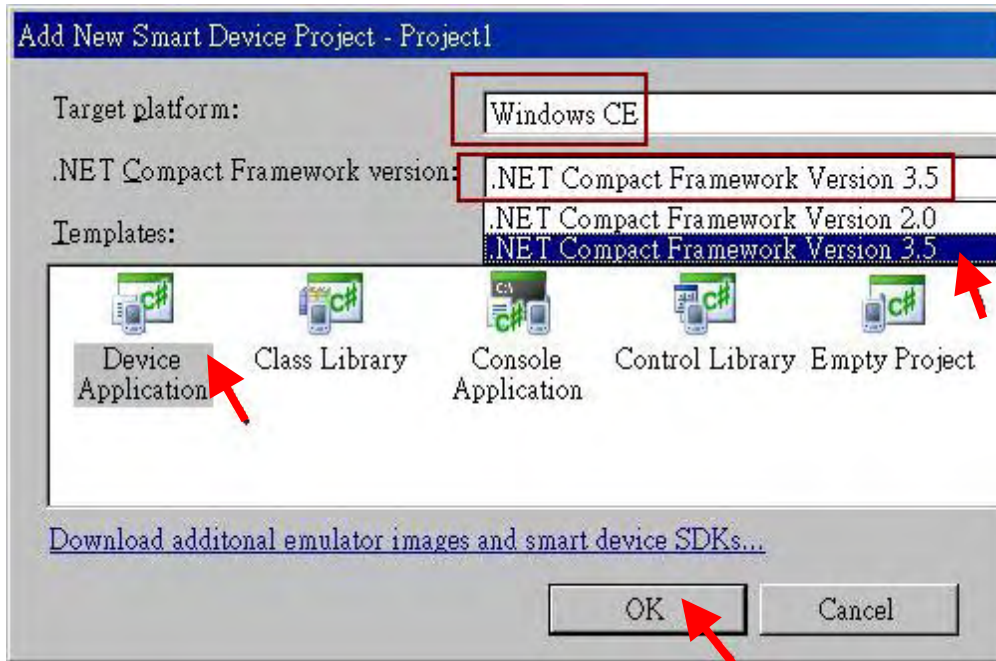

10.2 Add Project Reference for an Application

The "QuickerNet" library contains all modules' functions. Before you use the "Quicker" keyword in the program, you must add the "QuickerNet.dll" into the reference list of your application.

1. Right click on the Project name on the right hand side , then select "Add Reference ..."

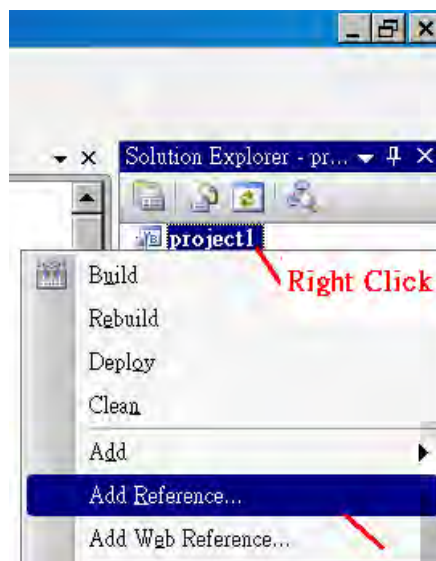

2. Select the “**mscorlib**” in the list box and click the button “**OK**” (the component “**mscorlib**” must appear in the Selected Components area)

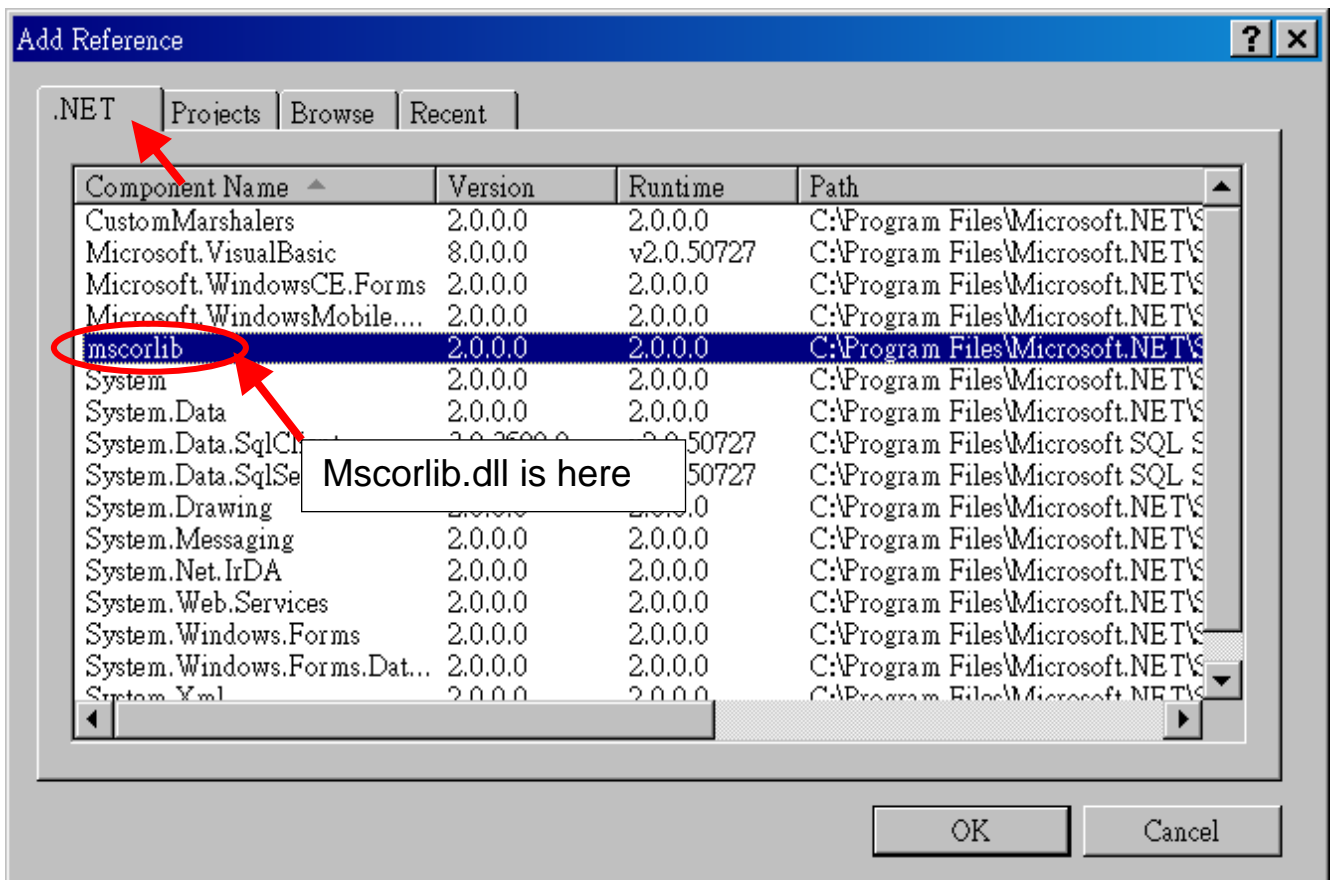

3. Click the “**Browse**” button. Select the “**QuickerNet.dll**” from **XP-8xx7-CE6 CD-ROM** :

[\napdos\isagraf\xp-8xx7-ce6\xpce6-CSharp.net-2008-demo\wp_CSharp01](#) subfolder or from your own location.

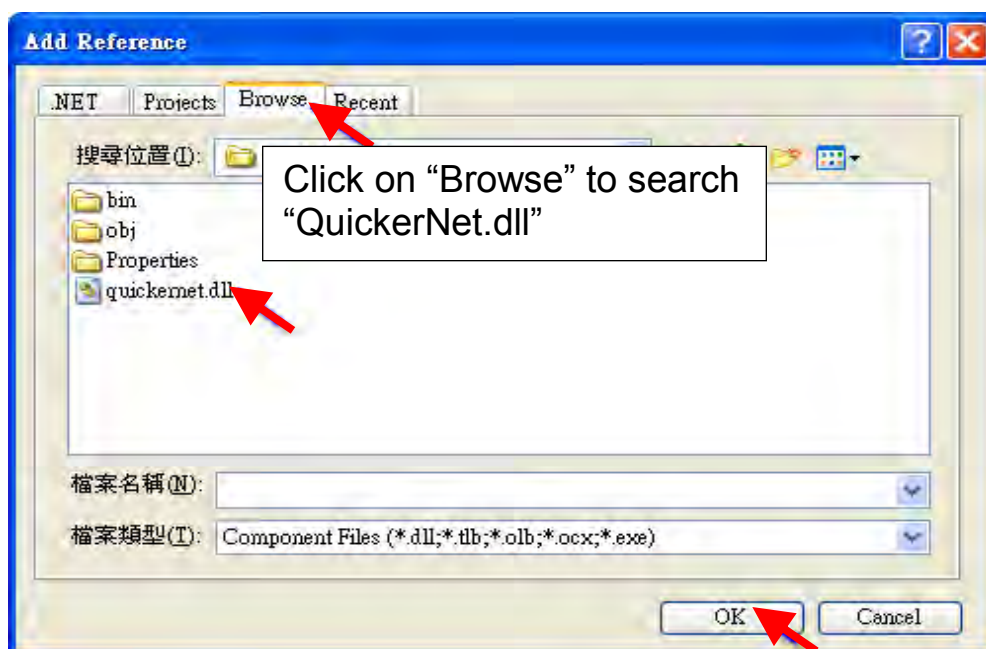

4. When both “mscorlib” and “QuickerNet.dll” are added, you can see them in the solution explorer as below

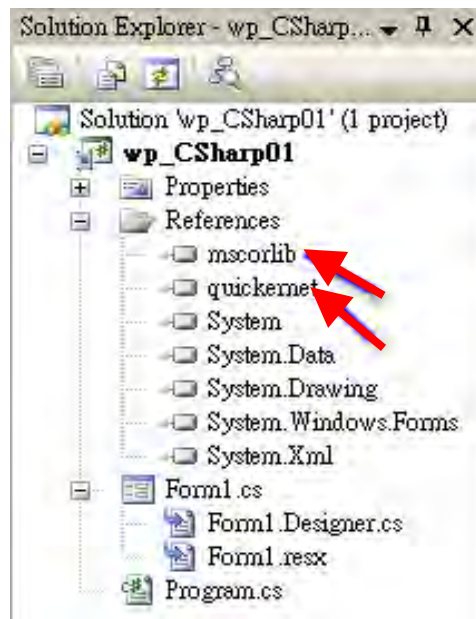

5. Right-click on the “Form1.cs” and select “View Code” from the pop-up. Move cursor to top and insert the “using Quicker;” in the first statements.

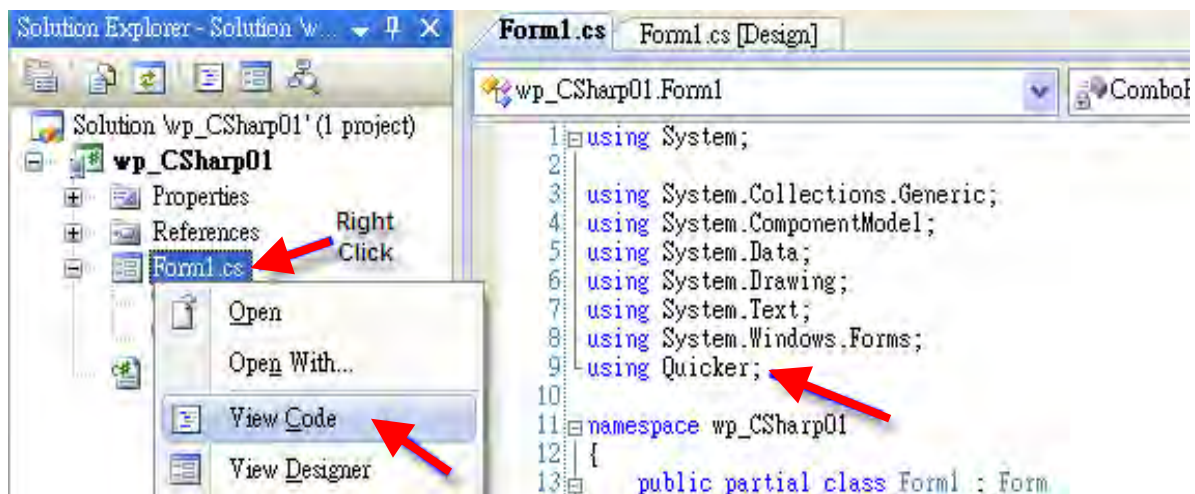

Then you can design all required objects and actions inside your C# Forms .

10.3 Compiling an Application Program

When you have finished writing a program, you can build an application by the following steps.

1. Remember to save at any time for safety.

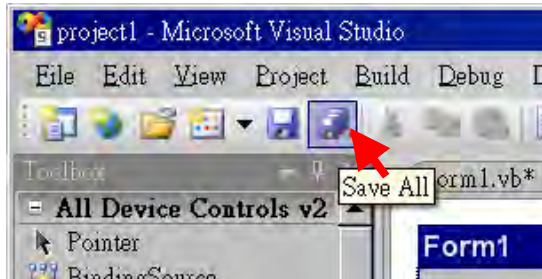

2. Then compile (Build) the project. The result is listed in the “Error List” windows at the bottom.

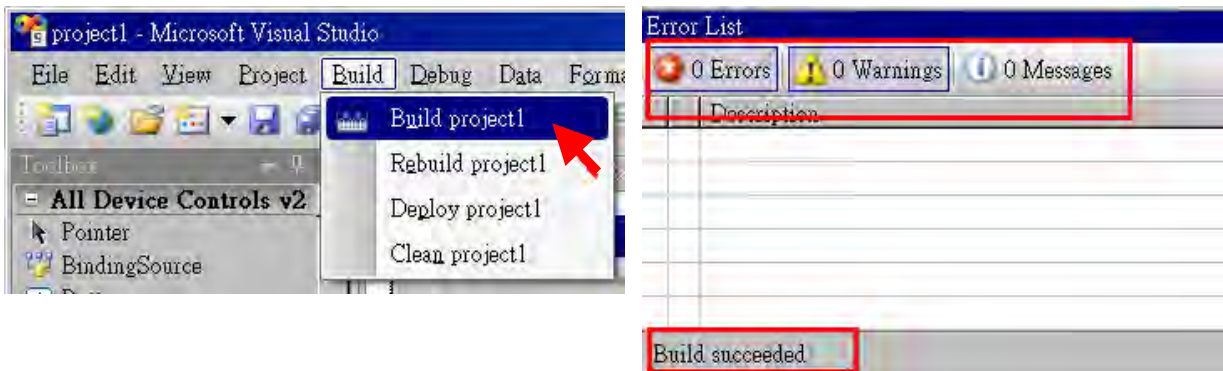

3. You can find the execution file in

<Your C# .net Project folder> \bin\Release\ <project_name>.exe

Please copy this execution file to the XP-8xx7-CE6 's [\System_Disk\ISaGRAF\](#) path to run it.

Note:

User may copy the C#.net execution file to other path to run it but there should contain at least three DLL files with it or it can not run correctly.

For ex, the project1.exe can run in the [\System_Disk\User\](#) path if there is three plus one file in it.

The “project1.exe” , “QuickerNet.dll” , “Quicker.dll” and “Mscorlib.dll” .

(The “QuickerNet.dll” , “Quicker.dll” and “Mscorlib.dll” can be copied from the XP-8xx7-CE6 's “[\System_disk\ISaGRAF\](#)” path)

10.4 QuickerNET.DLL

This section we will focus on the description of the application example of QuickerNET.DLL functions. There are some functions that can be used to R/W data from/to the ISaGRAF softlogic. The functions of QuickerNET.DLL can be clarified as two groups as depicted as below:

1. Digital R/W Functions
2. Analog R/W Functions

10.4.1 Digital R/W Functions

■ UserSetCoil

Description:

This function is to set the value to a Boolean variable by Modbus network address.

Syntax:

UserShare.UserSetCoil(ushort iUserAddress, byte iStatus)

Parameter:

iUserAddress : Specify the Modbus Network Address of Variable (1 to 8191)
iStatus : Set the status. For instance, iStatus = 1 for True, iStatus = 0 for False

Return Value:

None

Example:

```
// Set the output variable of Modbus Network Address "1" to True.  
UserShare.UserSetCoil(Convert.ToUInt16(1), 1);
```

Demo program :

XP-8xx7-CE6 CD-ROM:

[\napdos\isagraf\xp-8xx7-ce6\xpce6-CSharp.net-2008-demo\wp_CSharp01](#)

■ UserGetCoil

Description:

This function is to get the value from a boolean variable by Modbus network address.

Syntax:

UserShare.UserGetCoil(ushort iUserAddress, out byte iStatus)

Parameter:

iUserAddress : Specify the Modbus Network Address of Variable (1 to 8191)

iStatus : Get the variable status , iStatus = 1 for True, iStatus = 0 for False

Return Value:

None

Example:

```
// Get the variable status of Network Address "1".
```

```
byte iStatus;
```

```
UserShare.UserGetCoil(Convert.ToUInt16(1),out iStatus);
```

Demo program :

XP-8xx7-CE6 CD-ROM:

[\napdos\isagraf\xp-8xx7-ce6\xpce6-csharp.net-2008-demo\wp_csharp01](#)

10.4.2 Analog R/W Functions

■ UserSetReg_short

■ UserSetReg_long

■ UserSetReg_float

Description:

These functions are to set 16-bit short integer , 32-bit long integer & 32-bit float value to the specified Modbus network address.

Syntax:

```
UserShare.UserSetReg_Short(ushort iUserAddress, out int iStatus)
UserShare.UserSetReg_Long(ushort iUserAddress, out int iStatus)
UserShare.UserSetReg_Float(ushort iUserAddress, out float iStatus)
```

Parameter:

iUserAddress : Specify the Network Address of Variable (1 to 8191)
iStatus : Set the short or long integer or float value.

Example:

```
// Set a long value "1234567" to the variable of Modbus Network Address "1".
int temp1=1234567;
UserShare.UserSetReg_long(Convert.ToUInt16(1), out temp );
```

```
// Set a short value "-1234" to the variable of Modbus Network Address "3".
int temp2= -1234;
UserShare.UserSetReg_short(Convert.ToUInt16(3), out temp2 );
```

```
// Set a float value "2.174" to the variable of Modbus Network Address "4".
float temp3=2.174;
UserShare.UserSetReg_float(Convert.ToUInt16(4), out temp3 );
```

Demo program :

XP-8xx7-CE6 CD-ROM:

1. [\napdos\isagraf\xp-8xx7-ce6\xpce6-csharp.net-2008-demo\wp_csharp02](#)
for R/W analog I/O
2. [\napdos\isagraf\xp-8xx7-ce6\xpce6-csharp.net-2008-demo\wp_csharp03](#)
for R/W internal long integer, Timer and Real (floating-point) values.

Note:

The long integer & timer & real variable's Network Address No. must occupy 2 No. in the ISaGRAF project.

(Refer to section 4.2 of "User's Manual of ISaGRAF PACs" or in the CD-ROM:[\napdos\isagraf\xp-8xx7-ce6\english-manu\](#)
"User_Manual_I_8xx7.pdf")

■ **UserGetReg_short**

■ **UserGetReg_long**

■ **UserGetReg_float**

Description:

These functions are to get 16-bit short integer , 32-bit long integer & 32-bit float value from the specified Modbus network address.

Syntax:

```
UserShare.UserGetReg_Short(ushort iUserAddress, out int iStatus)
```

```
UserShare.UserGetReg_Long(ushort iUserAddress, out int iStatus)
```

```
UserShare.UserGetReg_Float(ushort iUserAddress, out float iStatus)
```

Parameter:

iUserAddress : Specify the Network Address of Variable (1 to 8191)

iStatus : Get the short or long integer or float value.

Example:

```
float float_val
```

```
short short_val
```

```
int long_val
```

```
// Get float value of the variable of Modbus Network Address "7".  
UserShare.UserGetReg_float(Convert.ToUInt16(7),out float_val);
```

```
// Get long value of the variable of Modbus Network Address "9".  
UserShare.UserGetReg_long(Convert.ToUInt16(9),out long_val);
```

```
// Get short value of the variable of Modbus Network Address "11".  
UserShare.UserGetReg_short(Convert.ToUInt16(11),out short_val) ;
```

Demo program :

XP-8xx7-CE6 CD-ROM:

1. [\napdos\isagraf\xp-8xx7-ce6\xpce6-csharp.net-2008-demo\wp_csharp02](#)
for R/W analog I/O
2. [\napdos\isagraf\xp-8xx7-ce6\xpce6-csharp.net-2008-demo\wp_csharp03](#)
for R/W internal long integer, Timer and Real (floating-point) values.

Note:

The long integer & timer & float variable's Network Address No. must occupy 2 No. in the ISaGRAF project

**(Refer to section 4.2 of "User's Manual of ISaGRAF PACs" or in the CD-ROM:[\napdos\isagraf\xp-8xx7-ce6\english-manu\](#)
"User_Manual_I_8xx7.pdf")**

Chapter 11 Motion Control - Using I-8094F/8092F/8094

NOTE: XP-8xx7-CE6 supports motion functions and provides Soft-GRAF HMI demos (Refer to Section 11.7.1) since Ver.1.09. Download the latest driver at <http://www.icpdas.com/products/PAC/i-8000/isagraf-link.htm>

This chapter is about ISaGRAF Motion Control using I-8094F / I-8092F / I-8094 modules. The design method is introduced step-by-step by showing how to create a demo example. All the ISaGRAF demo examples are shown with HMI demos developed by Soft-GRAF.

The hardware/software listed below is the basic requirement for the demos in this chapter: one XP-8xx7-CE6 PAC plus one I-8094F or I-8092F motion module. For different motion control applications, please refer to the following website for more devices:

ICP DAS products: <http://www.icpdas.com/products/Products-list.htm>

Motion control modules:

http://www.icpdas.com/products/motion/motion_I8K_Guide.htm

11.1 Hardware / Software Requirement

Hardware Requirement for the demo examples :

Type	Module	Description	Remark
Controller	XP-8xx7-CE6	ISaGRAF XPAC-CE6 PAC	The leftmost I/O slot number of XP-8xx7-CE6 is slot 1.
Motion Modules	I-8092F	2-axis High Speed Motion Control Module card	With one FRnet master port
	DN-8237G	Daughter board for I-8092F	
	CA-3710DM	Cable for I-8092F: 37 Pin Dsub	Connect card with daughter board
	I-8094(F)	4-axis High Speed Motion Control Module card	I-8094F: With FRnet master I-8094: Without FRnet master
	DN-8468G	Daughter board for I-8094(F)	
	CA-SCSIxx	Cable for I-8094F: 68-pin SCSI-II	Connect card with daughter board: CA-SCSI15: length 1.5M CA-SCSI30: length 3 M CA-SCSI50: length 5 M
Power	DP-665	Industrial power supply	
Other Devices	Monitor	VGA port	
	USB mouse	USB port	
	NS-208/NS-205	Industrial Ethernet switch	

Hardware Wiring :

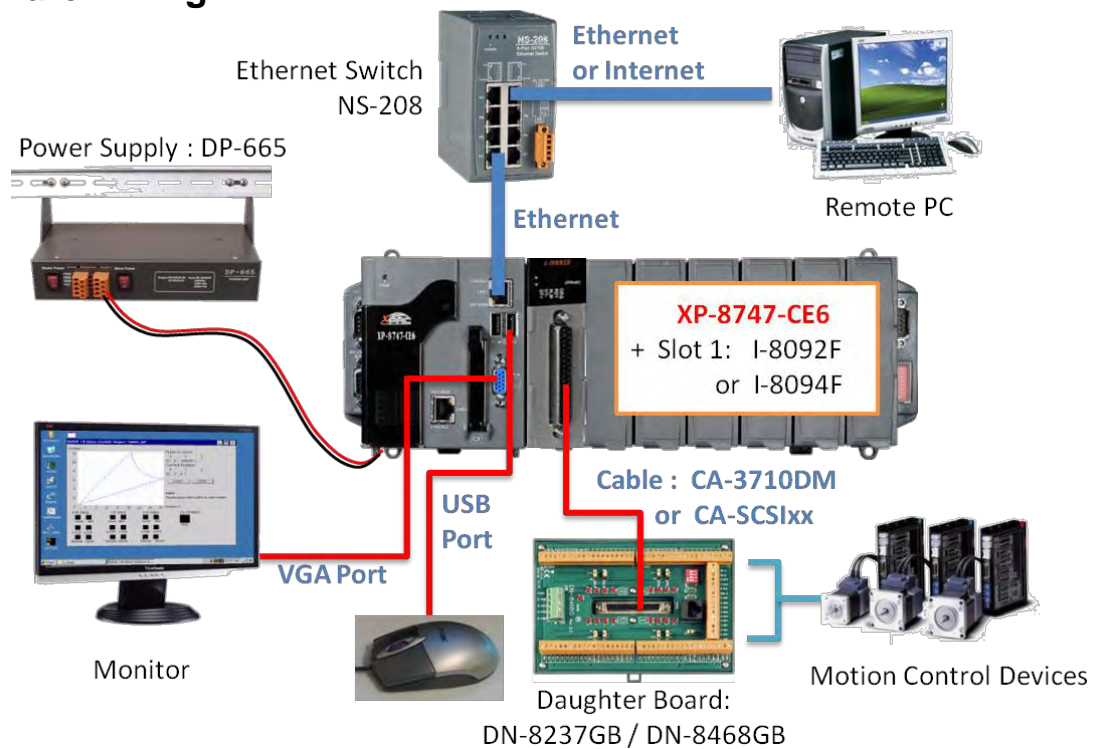

ISaGRAF IO Library :

Item	Type	Project
1	I/O connection file	"i_8092f.xia" : for I-8092F "i_8094f.xia" : for I-8094F/8094
2	Motion C function	"z8094.uia" : for I-8094F/8094/8092F

ISaGRAF Demo Programs :

Please refer to Section 11.7 for detail demo descriptions.

Item	Type	Project
1	I-8094F/8094 demo files	"M94_01.pia", "M94_01a.pia", "M94_01b.pia", "M94_01c.pia", "M94_01d.pia", "M94_02.pia", "M94_02a.pia", "M94_02b.pia", "M94_03.pia", "M94_04.pia", "M94_05.pia", "M94_06.pia"
2	I-8092F demo files	"M92_01.pia", "M92_01a.pia", "M92_01b.pia", "M92_01c.pia", "M92_01d.pia", "M92_02.pia", "M92_02a.pia", "M92_02b.pia", "M92_03.pia"
3	Motion function file	"samp809.pia"

Before continuing this chapter, please copy all the files listed above to your PC and restore the demo program files to ISaGRAF Workbench (refer to XP-8xx7-CE6 Getting Started Ch.3.2).

NOTE:

If you have never installed ISaGRAF, please install the ISaGRAF software and "ICPDAS Utility for ISaGRAF". If you are not familiar with the ISaGRAF programming, please refer to the Chapter 2.1~2.2 of "Getting Started: The XP-8xx7-CE6 PAC". The Getting Started can be got from the following list.

XP-8xx7-CE6 CD : /napdos/isagraf/setup.exe

FTP : <ftp://ftp.icpdas.com/pub/cd/xp-8xx7-ce6/napdos/isagraf/>

Web :

http://www.icpdas.com/products/PAC/i-8000/getting_started_manual.htm

These files can be found in the XP-8xx7-CE6 CD (since version 1.09), FTP and FAQ-132 :

Three directories to get the files :

XP-8xx7-CE6 CD : /napdos/isagraf/

FTP : <ftp://ftp.icpdas.com/pub/cd/xp-8xx7-ce6/napdos/isagraf/>

FAQ-132 : <http://www.icpdas.com/faq/isagraf.htm>



11.2 Introduction and installation for I-8094F/8092F/8094

11.2.1 Introduction

The motion control modules, I-8094F/8092F/8094, support 4/2-axis stepping / servo motor controls with a maximum of 4M PPS pulse output rate for each axis. They provide several motion functions, such as 2/3-axis linear interpolation, 2-axis circular interpolation, T/S-curve acceleration/deceleration and auto-home- search... functions. Furthermore, based on its outstanding low CPU loading feature, several motion modules can be used on one XPAC controller at the same time and other I/O statuses can be monitored simultaneously.

11.2.2 Hardware Specification

I-8094F / I-8094 main specifications :

ASIC Chip : MCX314As

Number of axes : 4 axes, pulse-type output (Stepping or servo motor)

Maximum pulse output : 4M PPS

I-8092F main specifications :

ASIC Chip : MCX312

Number of axes : 2-axis, pulse-type output (Stepping or servo motor)

Maximum pulse output : 4M PPS

I-8092F / I-8094F / I-8094 interpolation functions :

2-axis / 3-axis Linear Interpolation :

Interpolation range : -2,147,483,646 ~ +2,147,483,646

Vectors speed of interpolation : 1 PPS ~ 4M PPS

Precision of interpolation : ± 0.5 LSB

Circular interpolation :

Interpolation range : -2,147,483,646 ~ +2,147,483,646

Vectors Speed of interpolation : 1 PPS ~ 4M PPS

Relative interpolation function :

Any 2-axis or 3-axis interpolation; Fixed vectors speed

11.2.3 Hardware Connection

I-8092F Module Connection Example :

[www.icpdas.com > Products > PAC > 8K & 87K I/O Modules > I-8092F-G > Manual > Getting Started > I-8092 Getting Started manual for PAC](http://www.icpdas.com/Products/PAC/8K%20&%2087K%20I/O%20Modules/I-8092F-G/Manual/Getting%20Started/I-8092%20Getting%20Started%20manual%20for%20PAC)

http://www.icpdas.com/products/motion/download%20data/Motion_download_I-8092F.htm

➤ Getting Started manual for PAC

I-8094F/8094 Module Connection Example :

[www.icpdas.com > Products > PAC > 8K & 87K I/O Modules > I-8094F-G > Manual > Getting Started > I-8094 Getting Started manual for PAC](http://www.icpdas.com/Products/PAC/8K%20&%2087K%20I/O%20Modules/I-8094F-G/Manual/Getting%20Started/I-8094%20Getting%20Started%20manual%20for%20PAC)

http://www.icpdas.com/products/motion/download%20data/Motion_download_I8094_I8094F.htm

➤ Getting Started manual for PAC

11.2.4 Installation for the Motion Module

Before the first time using the I-8094F / I-8092F / I-8094 modules, user has to update ISaGRAF Driver to V.1.09 or latter version and then install the Drivers, Libraries and the Utilities for the modules.

Step 1: Install the PAC CAB file

Run the “My Device” on the XPAC, switch to “\System_Disk\ISaGRAF”, and then double click the PAC file to install it.

I-8094(F) CAB file: i8094f_XP8KCE_20100208.CAB

I-8092F CAB file: i8092f_XP8KCE_20100208.CAB

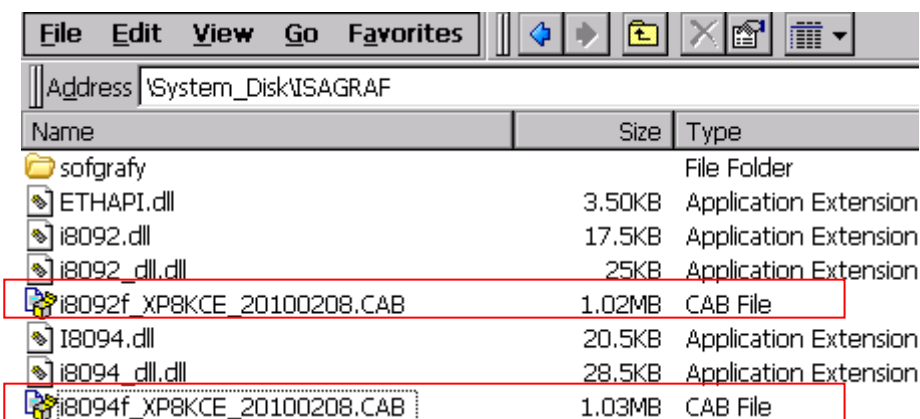

Now, the Drivers and Libraries are installed into the XP-8xx7-CE6; The Utilities are installed to the XP-8xx7-CE6, in the folder of “\System_Disk\i8094”.

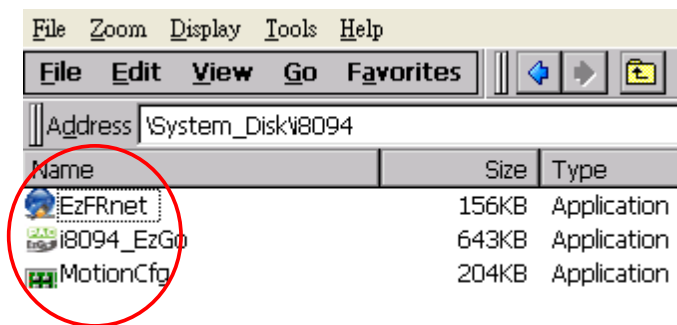

The Utilities files :

Item	Utility Name	Descriptions
1.	MotionCfg	A configuration utility to enable/disable the I-8094F/8094/8092F modules on the XP-8xx7-CE6 series.
2.	i8094_EzGo	A tool, similar to the PISO-PS400 PCEzGo, helps to indicate the status of each axis, configure the polarity of external sensors and demonstrate the basic/simple motion-controlling models.
3.	EzFRnet	Demonstrate the FRnet features.

Step 2 : Add system registries of I-8094F/I-8092F card: double click “\System_Disk\i8094\MotionCfg.exe” to open the “I-8012/I-8094 Configuration Tool” window, check the box “AddReg” that mapping to the module slot number, then click “Update Registries” and “OK”. If the module on the slot is changed, please execute "MotionCfg" again and then the module can be used well and correctly.

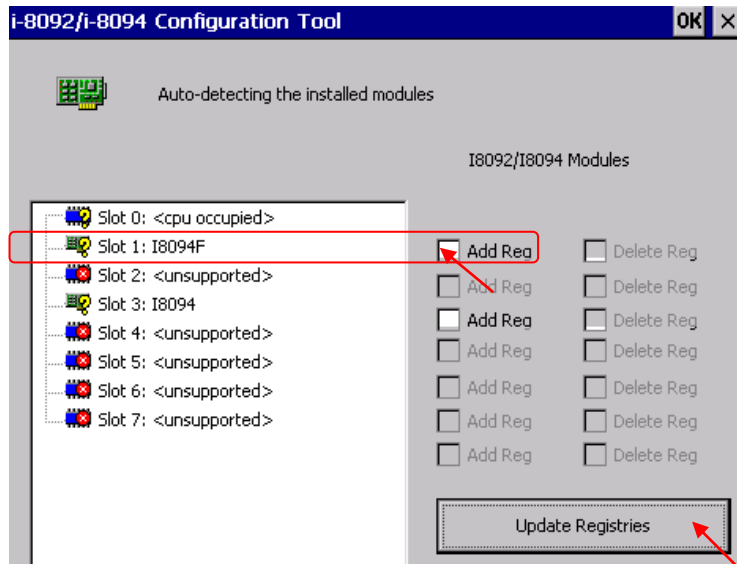

Step 3 : Run XPAC Utility(V.1.0.2.5 or latter Ver.), and click on [File] > [Save & Reboot] to reboot XPAC. (If users do not “Save & Reboot” the XPAC, the card may not work well. If the XPAC is in the Auto Save mode, it’s ok to “Reboot”).

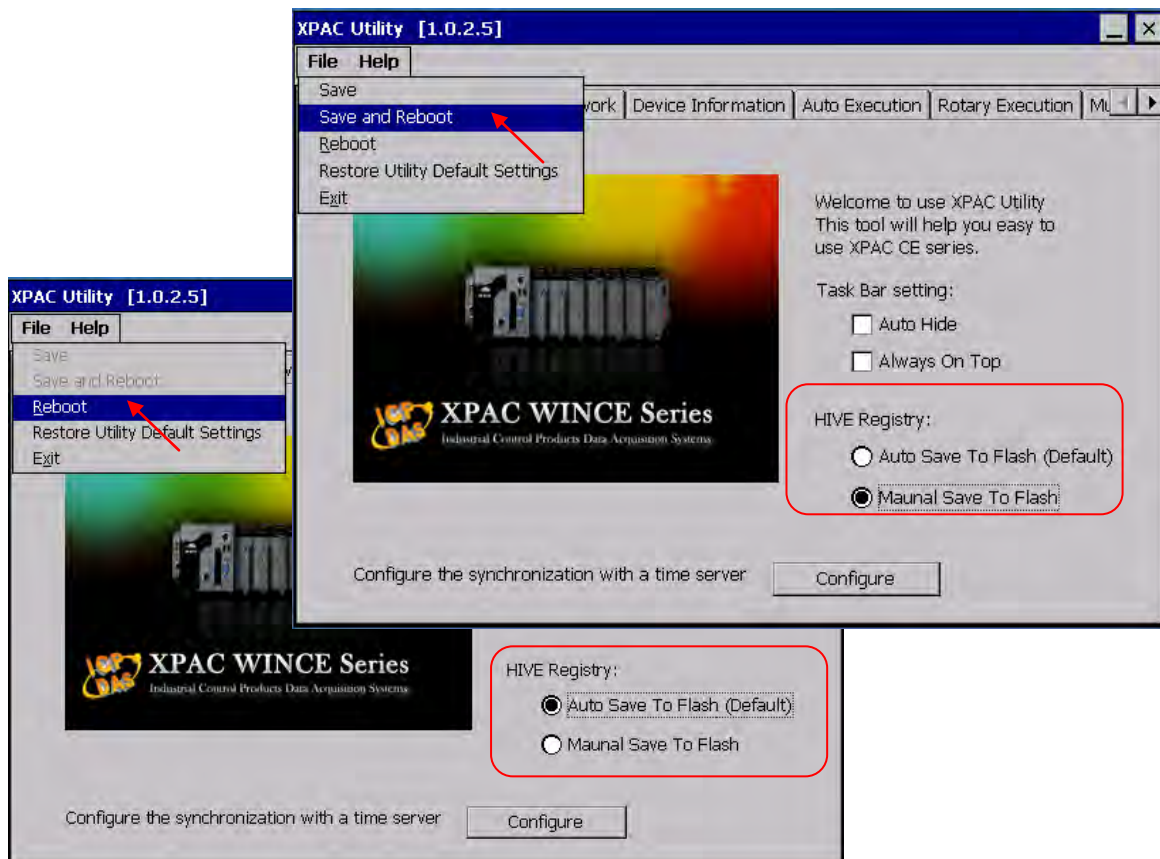

11.2.5 Install the C function “Z_8094” into the ISaGRAF

In this section, we will introduce how to install the C function “Z_8094” into the ISaGRAF Workbench for writing the ISaGRAF Motion programs.

Step 1: Run the ISaGRAF Workbench in the PC. Click [Tools] > [Libraries].

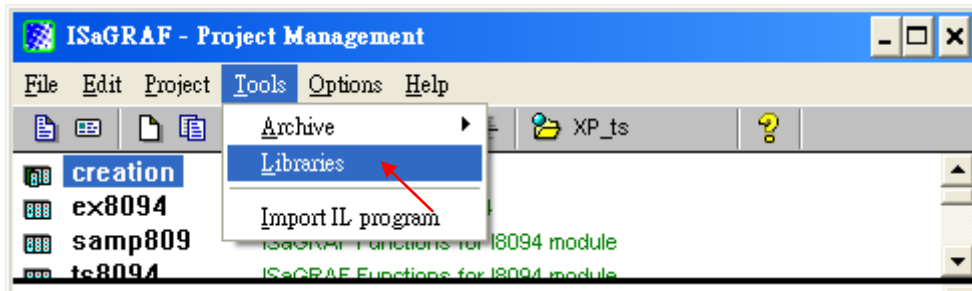

Step 2: Select [C functions]

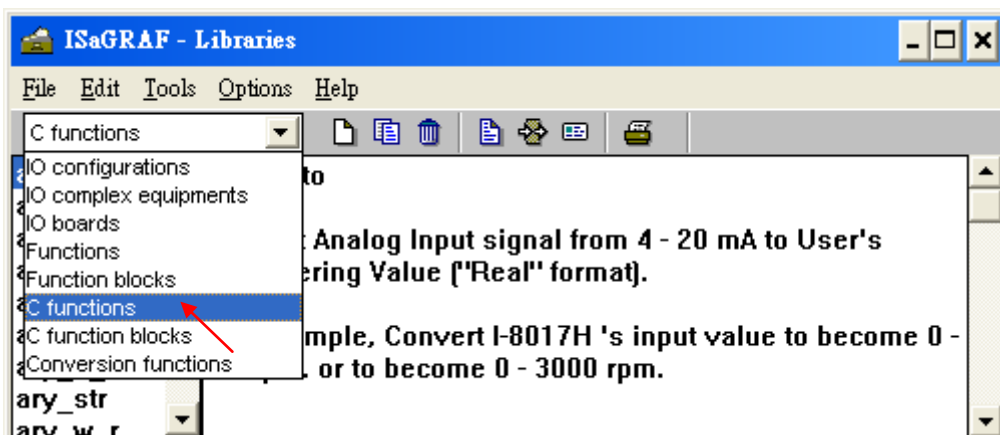

Step 3: Click [Tools] > [Archive]

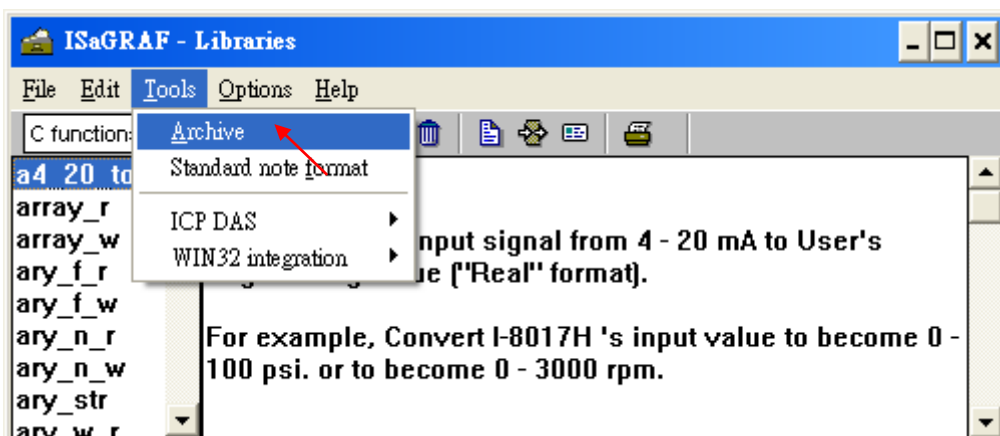

Step 4: Click [Browse] and switch to the folder that the Motion function file are downloaded. Click the motion function “z8094” in the [Archive] box, and click on [Restore] to install the C function “Z_8094” into the ISaGRAF.

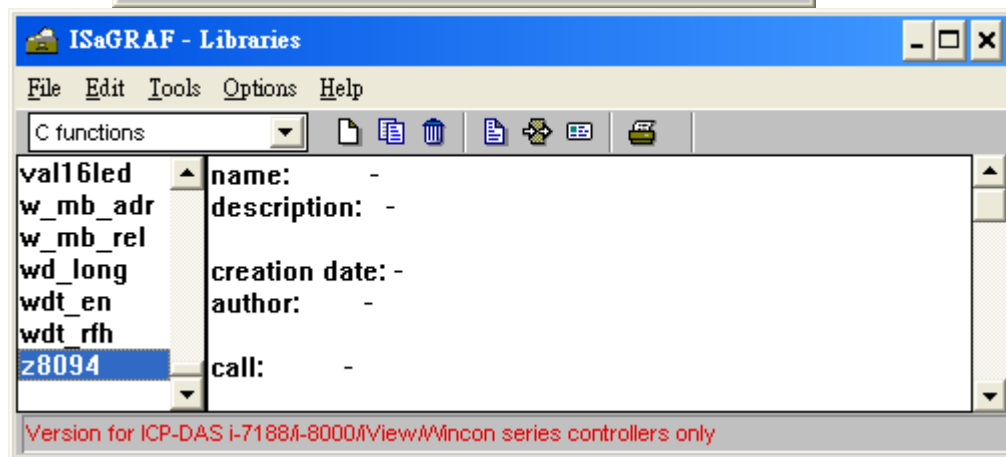
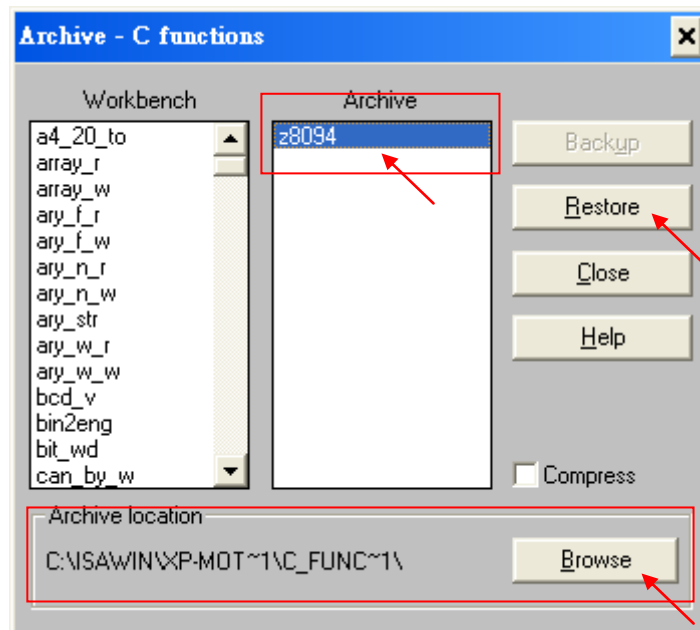

11.2.6 Install the I/O connection: i_8094f & i_8092f into the ISaGRAF

In this section, we will introduce how to install the I/O connection: i_8094f & i_8092f into the ISaGRAF Workbench for writing ISaGRAF Motion programs.

Step 1: In the ISaGRAF Workbench, click [Tools] > [Libraries]

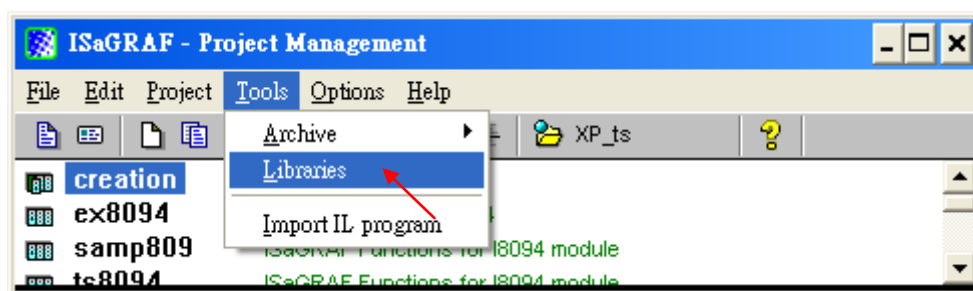

Step 2: Select [I/O complex equipments]

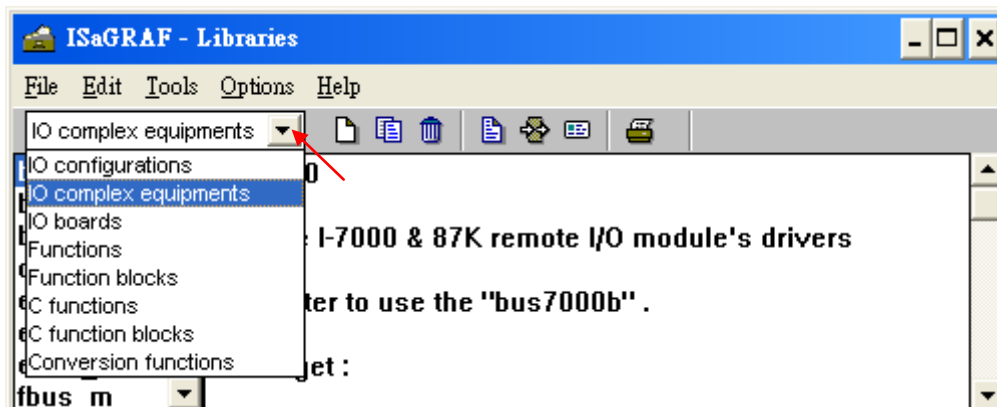

Step 3: Select [Tools] > [Archive]

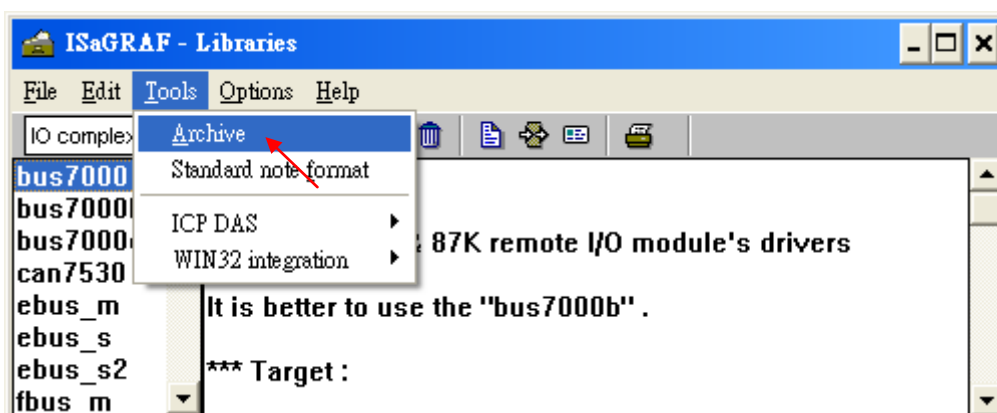

Step 4: Click [Browse] and switch to the folder that the I/O connection files are downloaded, then select the files in the [Archive] box (press and hold the "Shift" key to select continuous multiple files; press and hold the "Ctrl" key to select non-continuous multiple files.), then click [Restore] to install them into the ISaGRAF Workbench.

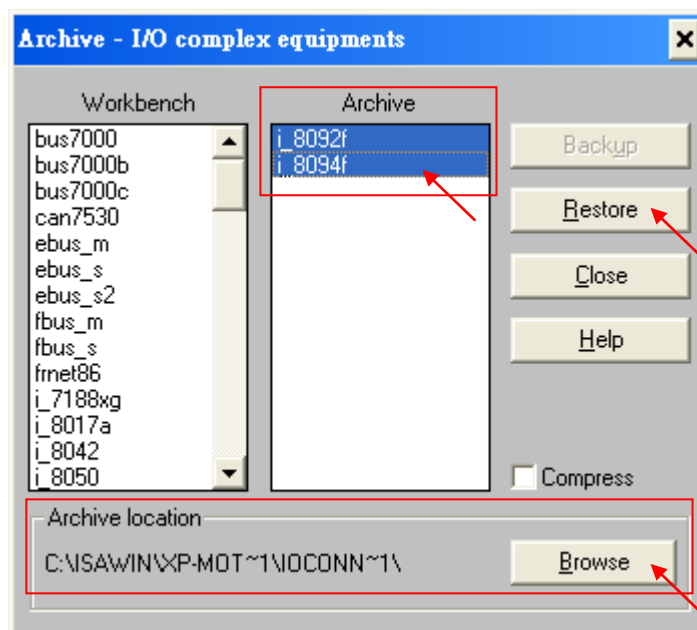

11.3 A simple Motion Example - Using I-8094F Module

In this section, we introduce how to program the motion control project, using I-8094F motion module, by creating a simple ISaGRAF example “M94_01”. All the motion functions are collected in the “samp809” file. We need to copy “samp809” into the new project and the method will be introduced in the following steps.

NOTE :

1. All about speed and pulse output setting must be set according to your actual motion machines to avoid any danger.
2. If you are not familiar with the ISaGRAF programming, please refer to the Chapter 2.1 of "Getting Started : The XP-8xx7-CE6 PAC".

XP-8xx7-CE6 CD : /napdos/isagraf/xp-8xx7-ce6/chinese-manu/

Web: http://www.icpdas.com/products/PAC/i-8000/getting_started_manual.htm

11.3.1 Create an ISaGRAF Motion Project

Please make sure the Motion demo files are restored already. If not yet, please refer to Ch.11.1 for the files. And refer to the Chapter 3.2. of XP-8xx7-CE6 Getting Started for the restoring steps.

In this section, user will create a simple ISaGRAF project (the same as the example “M94_01” when finish.) in the ISaGRAF Workbench and download to the XP-8xx7-CE6 PAC (slot1: I-8094F), then execute this project. This project includes 2 LD (LD1 & LD2) and one ST (HMI_1) programs which code can be copied from the “M94_01”. About the HMI_1, please refer to www.icpdas.com > FAQ > Software > ISaGRAF > FAQ-131 .

Step 1. Copy the Motion function file “samp809” to the new project. Double click the file to open it.

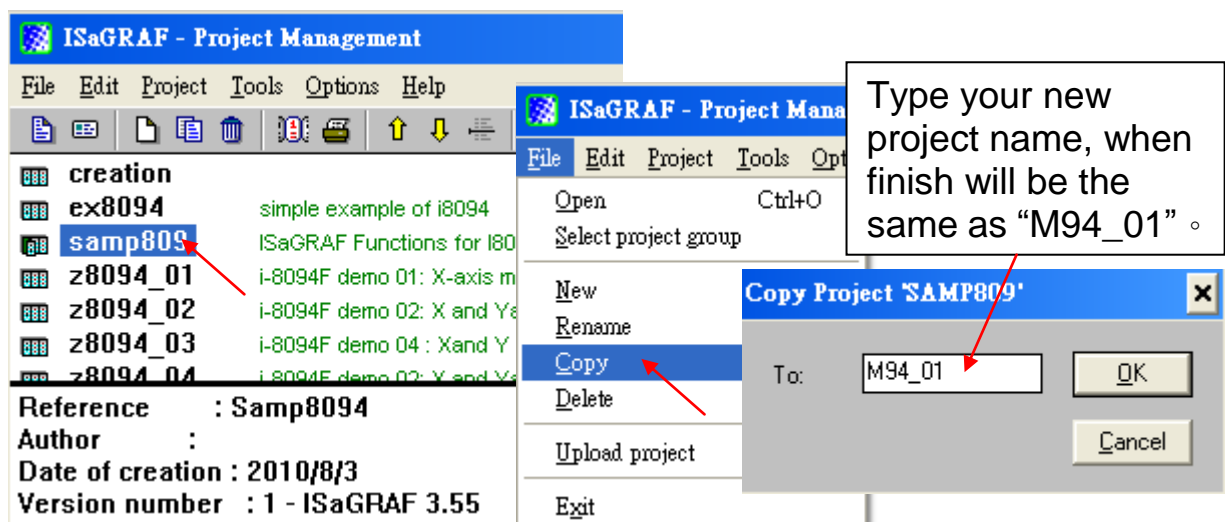

000	creation	
000	m92_01	XP-8xx7-CE6+slot0: i8092 (LD) ,1-axis find "NHome" then "Home" & pt to pt move
000	m92_01a	XP-8xx7-CE6+slot0: i8092 (ST) ,1-axis find "NHome" then "Home" & pt to pt move
000	m92_02	XP-8xx7-CE6+slot0: i8092 (LD) ,2-axis find "NHome" then "Home" & pt to pt move
000	m92_02a	XP-8xx7-CE6+slot0: i8092 (ST) ,2-axis find "NHome" then "Home" & pt to pt move
018	m94_01	XP-8xx7-CE6+slot0: i8094 (LD) ,1-axis find "NHome" then "Home" & pt to pt move
000	m94_01a	XP-8xx7-CE6+slot0: i8094 (ST) ,1-axis find "NHome" then "Home" & pt to pt move
000	m94_02	XP-8xx7-CE6+slot0: i8094 (LD) ,2-axis find "NHome" then "Home" & pt to pt move

Step 2. Click [File] > [New] or “Create new program” tool icon to create the LD program “LD1” & “LD2”.

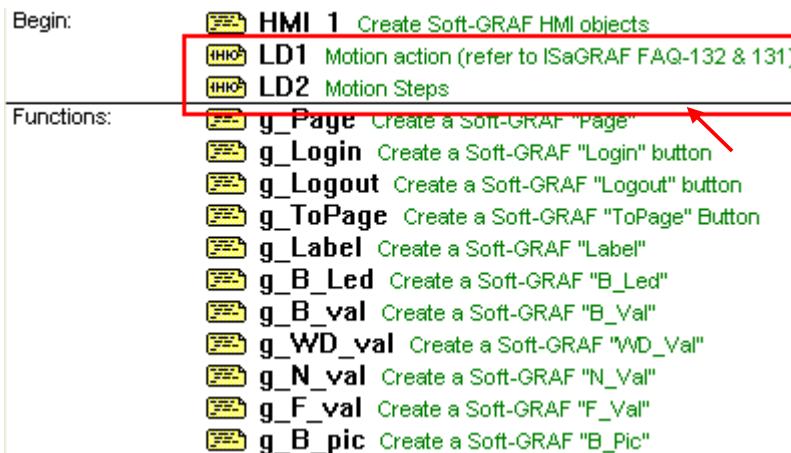
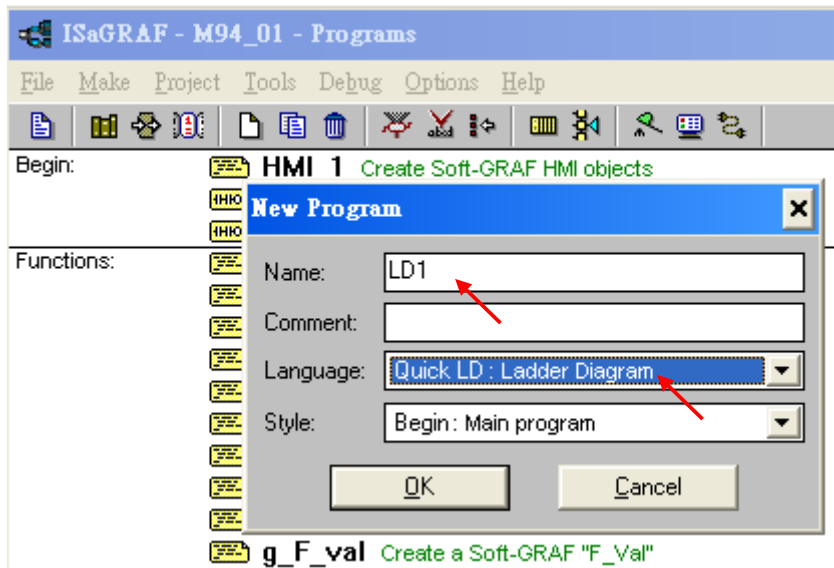

Step 3. Declare variables and write the ST code.

Variables Declaration :

Variable Name	Type	Attribute	Network addr.	Description
TMP	Boolean	internal		Temp variable for creating the Soft-GRAF HMI.
Soft_GRAF_init	Boolean	internal		Initial for Soft-GRAF HMI, default True
INIT	Boolean	internal		Initial for motion, default True
Start	Boolean	internal	1	Start the motion
Move_it	Boolean	internal	2	Move to the next point
Clear_Trace	Boolean	internal	3	Clear the HMI trace region
Set_i8094	Boolean	internal		Set the I-8094 parameters
Server_ON	Boolean	internal		Turn on the servo motor
Find_Home	Boolean	internal		Auto-search-home
Reset_ENCO	Boolean	internal		Reset the encoder value
Mov_PT	Boolean	internal		The needed pulses for the single-axis moving
Stop_Motion	Boolean	internal		Stop motion
Server_OFF	Boolean	internal		Turn off the servo motor
Limit_P_X	Boolean	input	11	Hardware limit+ signal
Limit_N_X	Boolean	input	12	Hardware limit- signal
EMG_X	Boolean	input	13	Emergency stop signal
NHome_X	Boolean	input	14	Hardware Near-Home signal
Home_X	Boolean	input	15	Hardware Home signal
DRV_X	Boolean	input	16	Check if the motor is running
Ack_Error	Boolean	internal	4	Check if the error code is set to 0
Slot_1	Integer	internal		The slot number of the card, default 1
X_AXIS	Integer	internal		X-axis of the card, default 1
Y_AXIS	Integer	internal		Y-axis of the card, default 2

Variable Name	Type	Attribute	Network addr.	Description
Z_AXIS	Integer	internal		Z-axis of the card, default 4
U_AXIS	Integer	internal		U-axis of the card, default 8
ACC_T_X	Integer	internal		Set the acceleration of X-axis
DEC_T_X	Integer	internal		Set the deceleration of X-axis
Mov_Pulse_cnt_X	Integer	internal		Calculate how many pulses need to move. Can be negative.
Mov_Speed_X	Integer	internal		The average speed of moving
Step	Integer	internal		Check the current moving step
TMP_Int	Integer	internal		The temp variable for moving function
Current_point_X	Integer	input		Current point of the X-axis
Next_Point_X	Integer	internal		Move to the next point
Z_Done_X	Integer	internal		Check if the moving done
Trace_type_x	Integer	internal		For the Soft-GRAF trace function, default 1
Error_code	Integer	internal		The error code for the moving

Ladder Program (LD1) :

(Type the code or copy from the "LD1" in the project "M94_01")

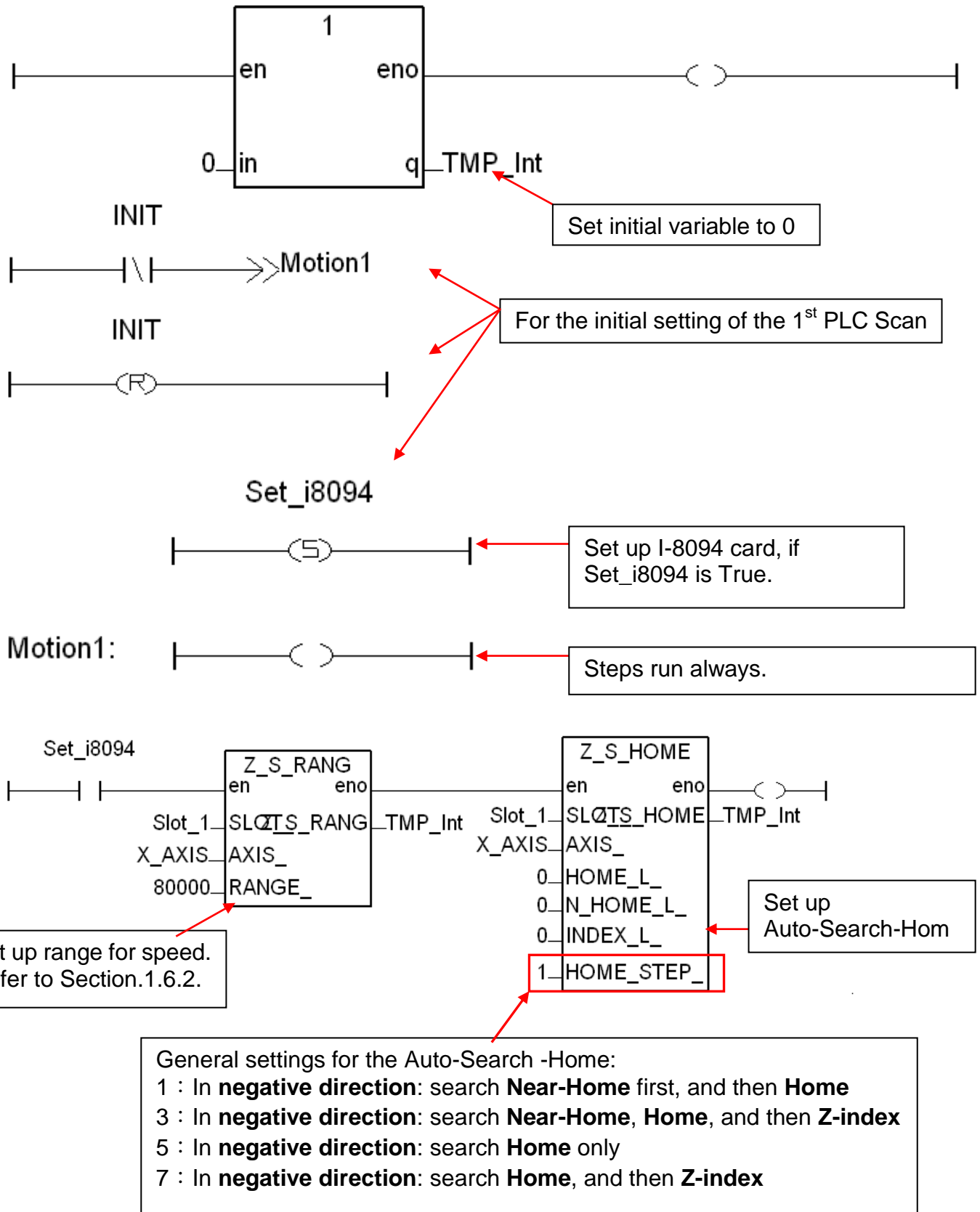

Set_i8094

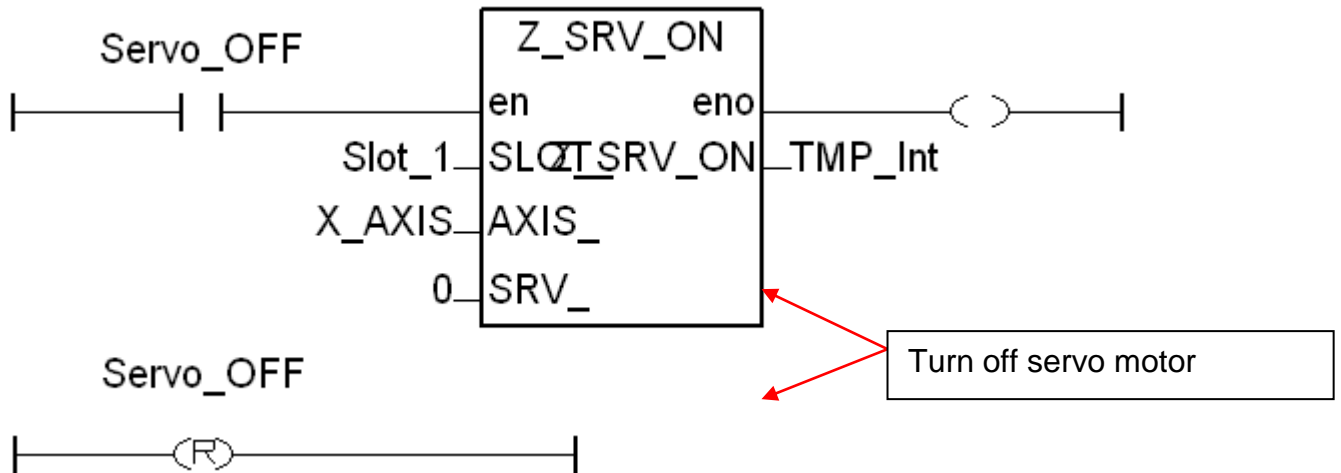
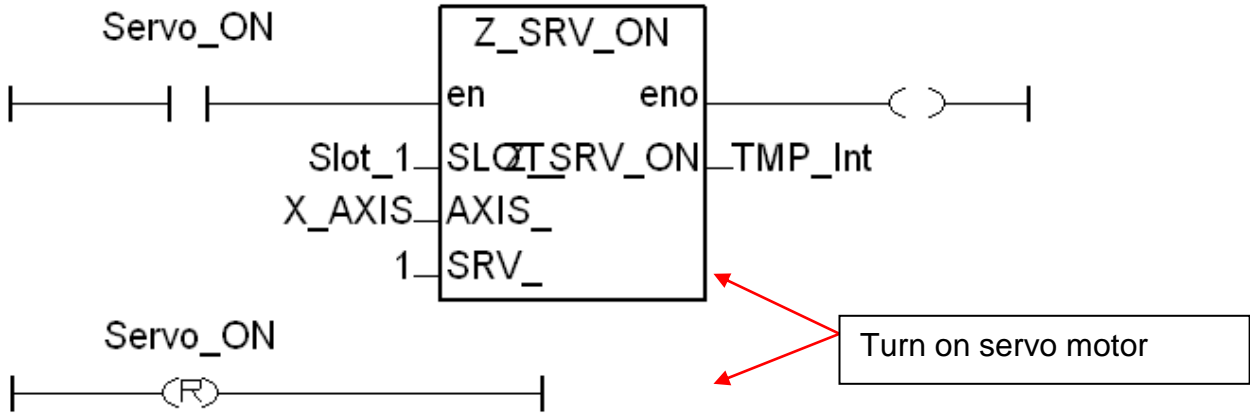

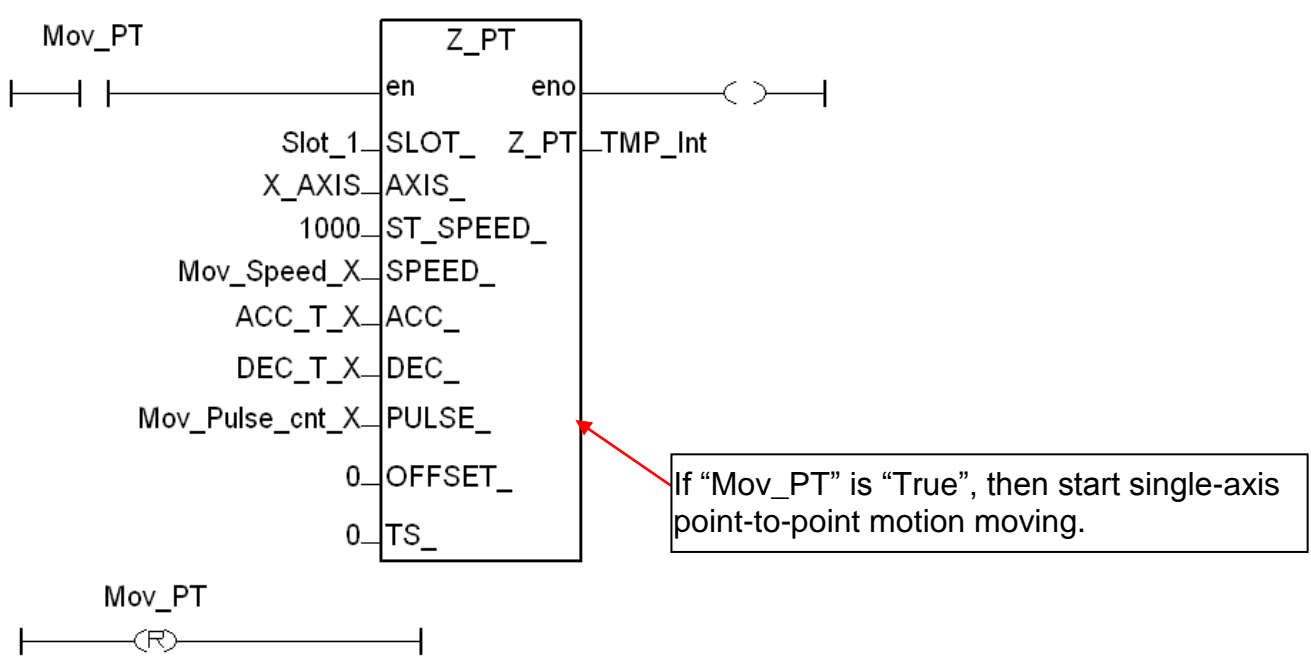
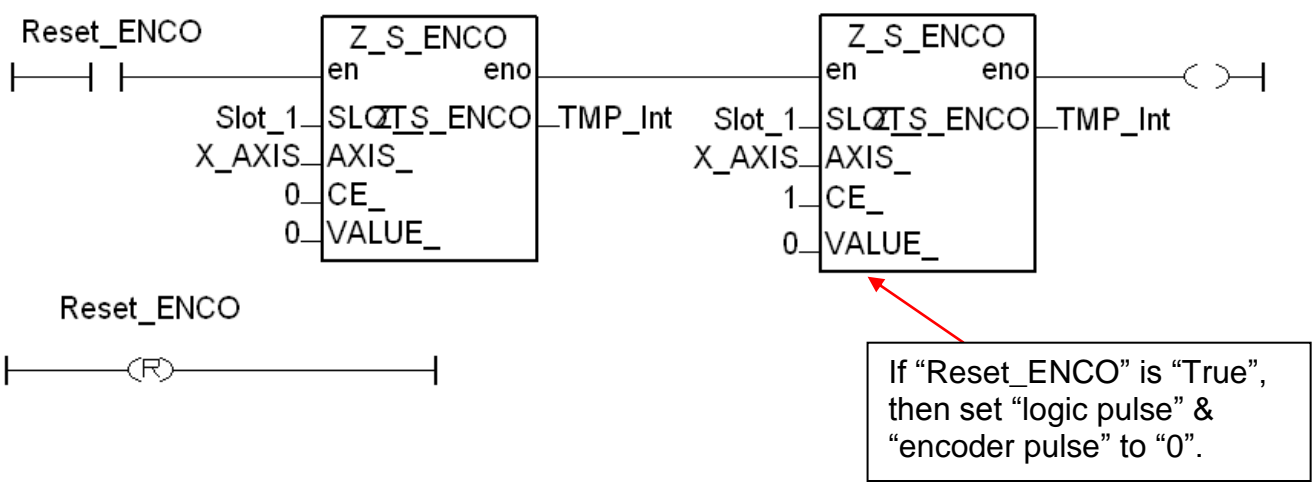
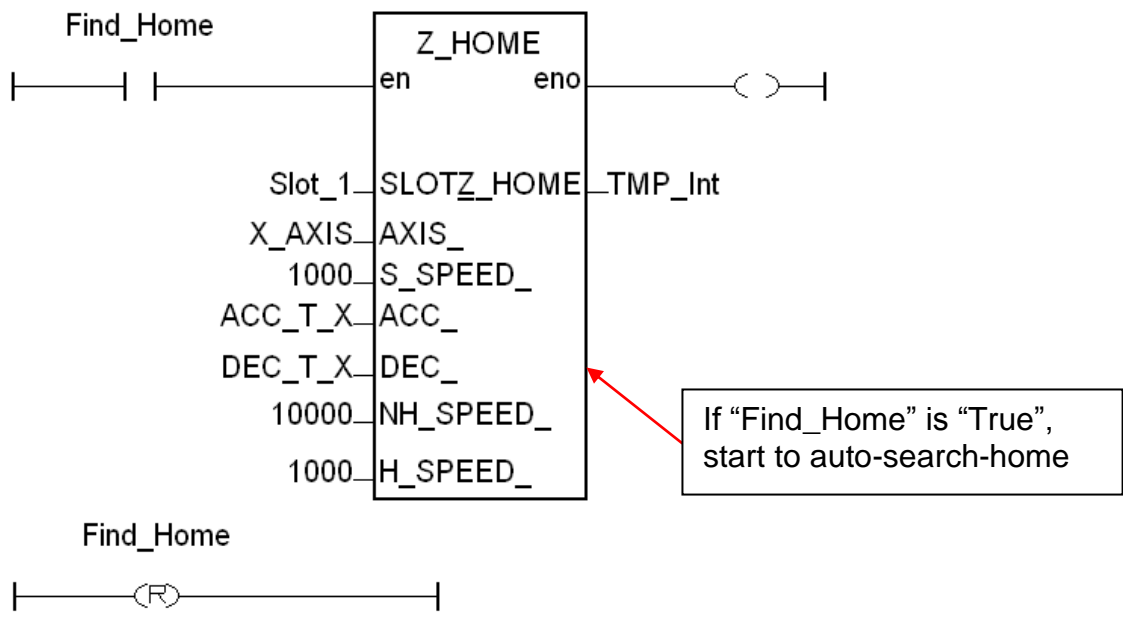

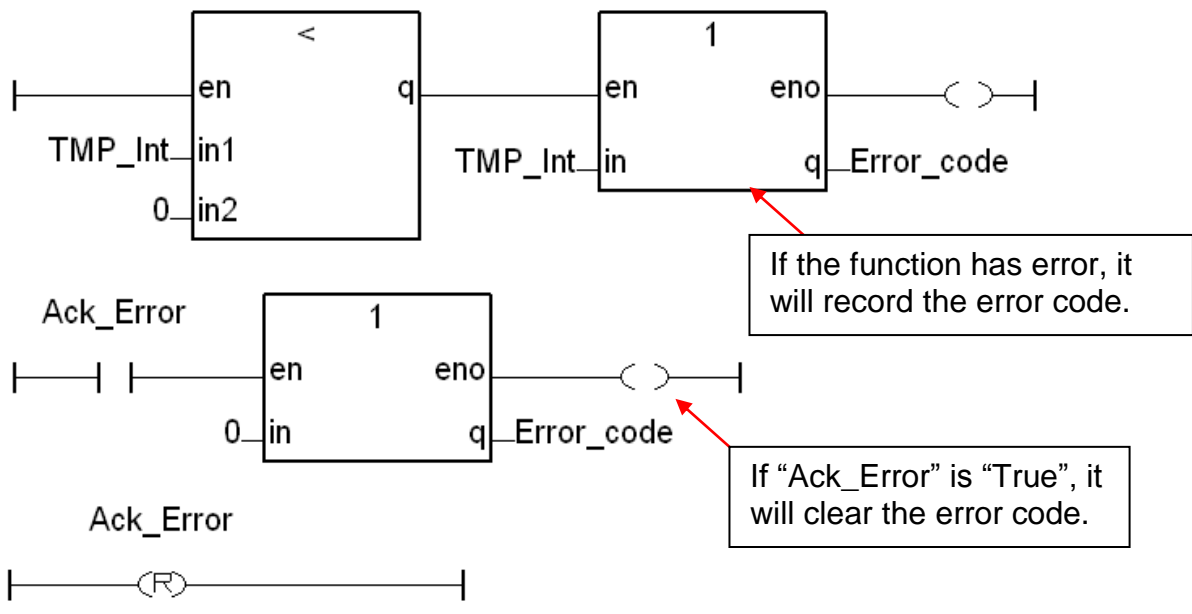
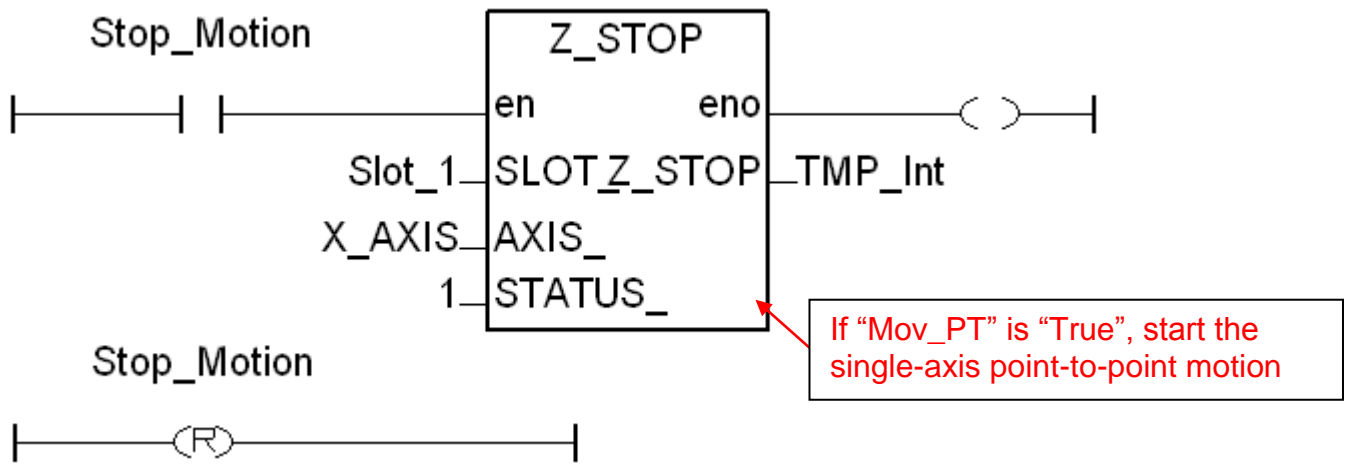

Ladder Program (LD2) :

(Type the code or copy from the "LD2" in the project "M94_01")

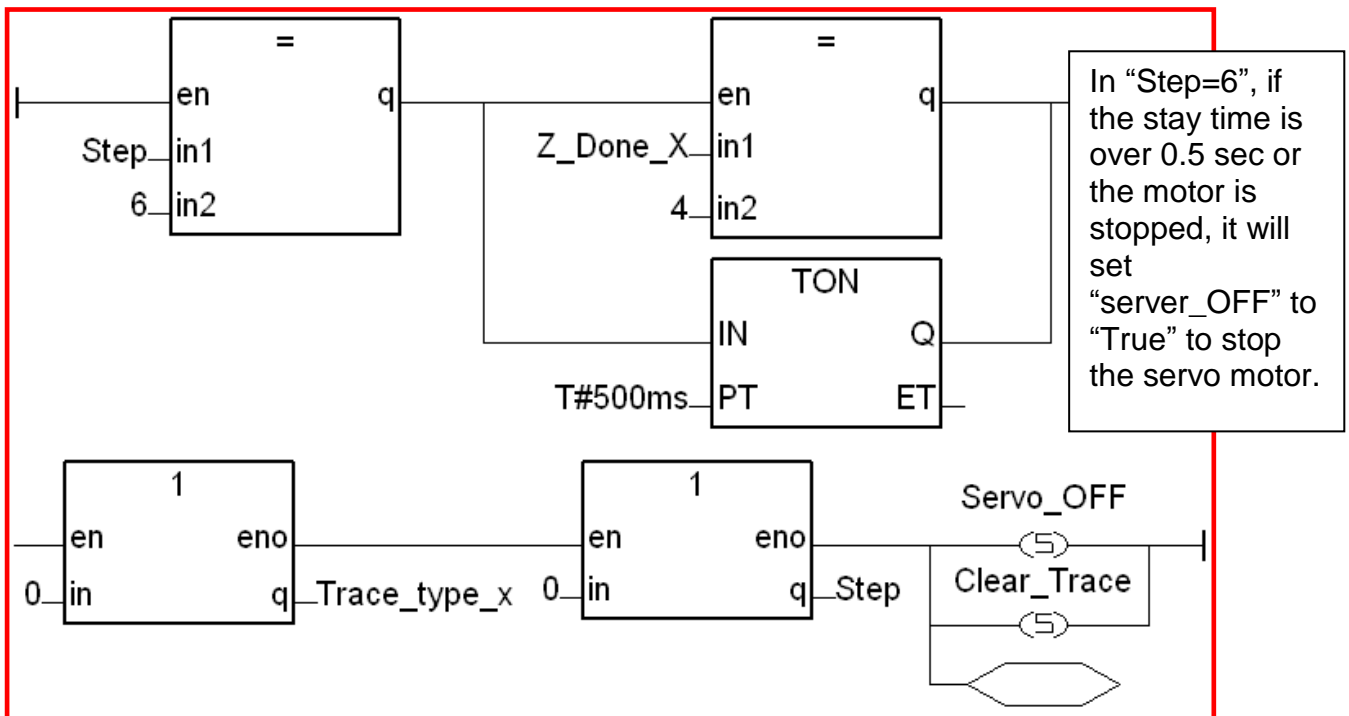
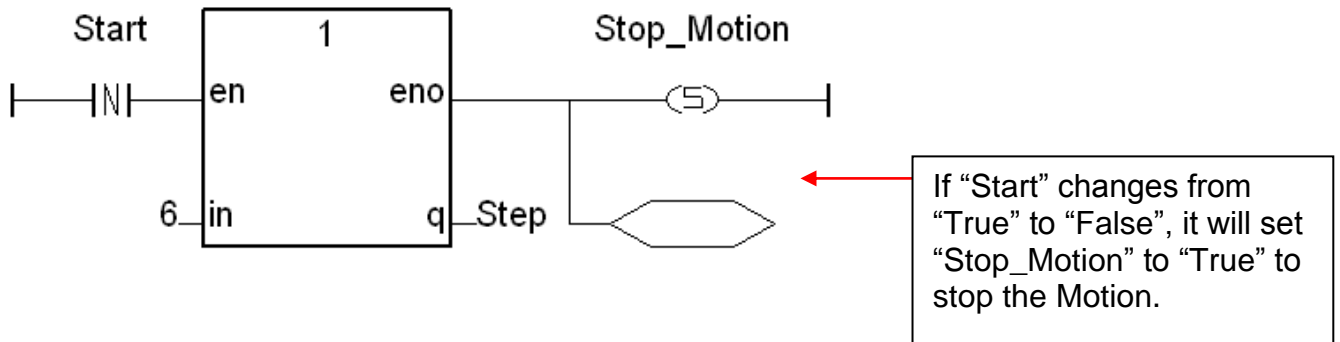
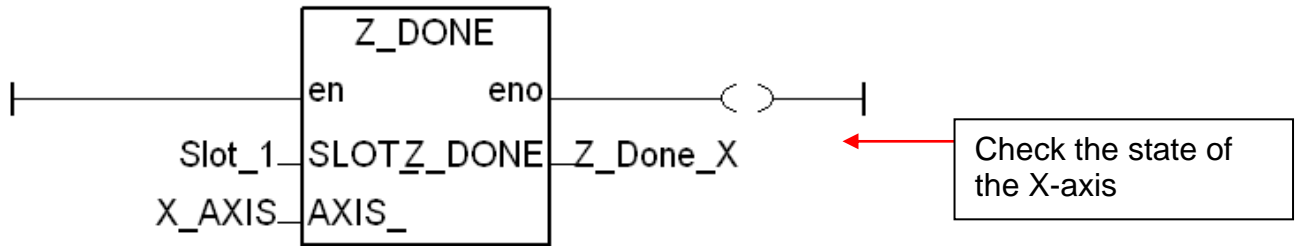

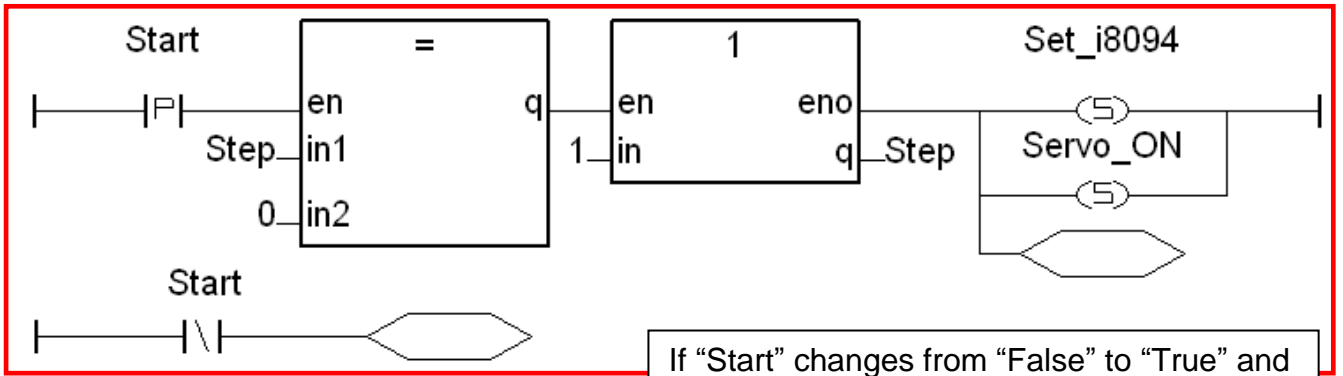

The following program is running only if "Start=True".

If "Start" changes from "False" to "True" and "Step=0", then set Step=1, Set_i8094=True, Server_ON=True, to set up the card and turn on the servo motor.

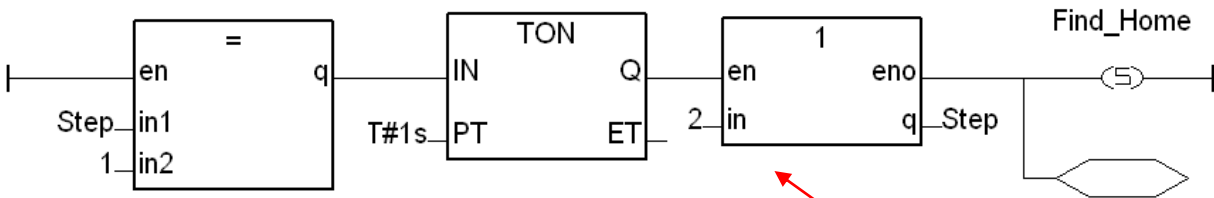

In "Step=1", if stay over 1 sec, set "Find_Home" to "True" to start the Auto-Search-Home.

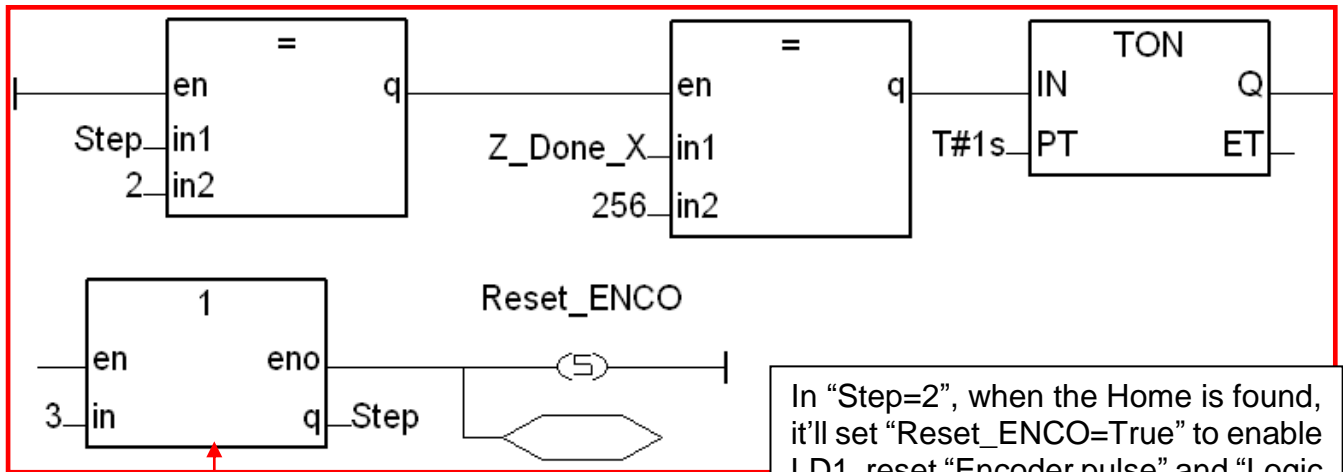

In "Step=2", when the Home is found, it'll set "Reset_ENCO=True" to enable LD1, reset "Encoder pulse" and "Logic pulse".

※ When the Home is found, the program must wait for a little time to start any other motion function to ensure "Encoder" has been reset correctly.

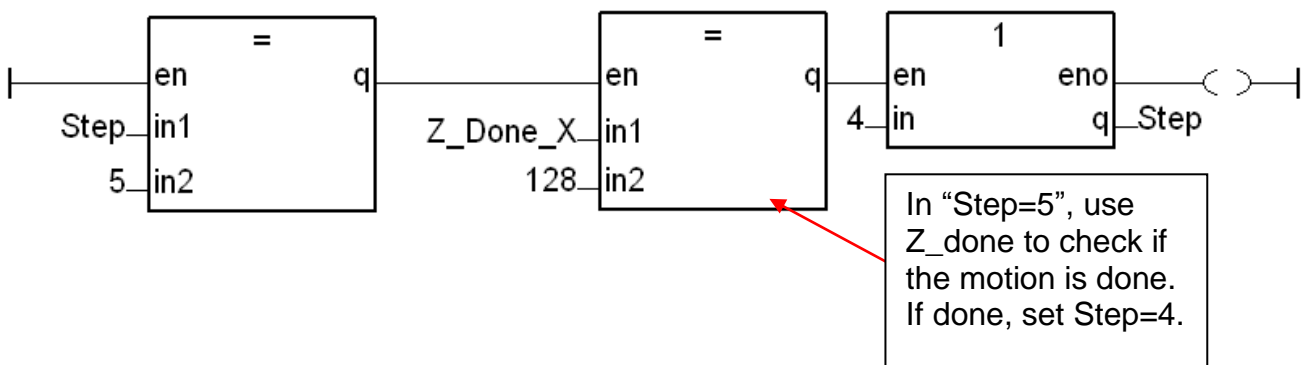
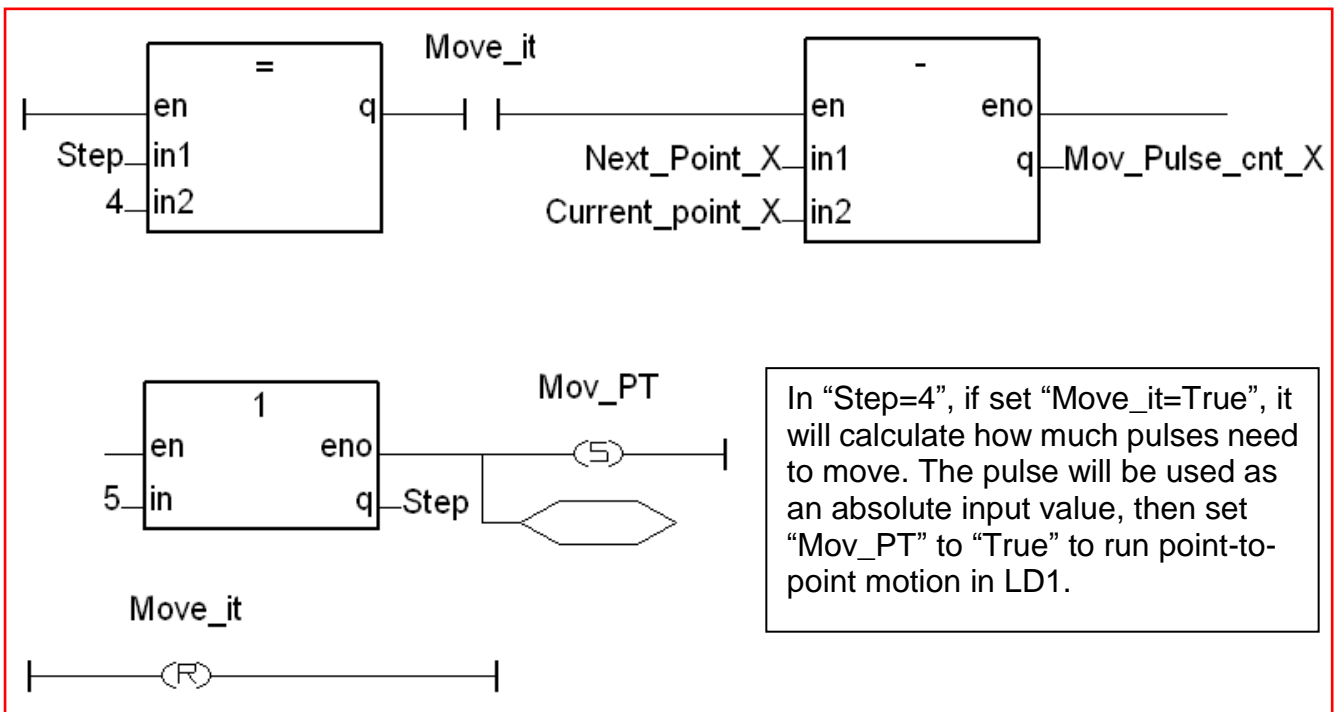
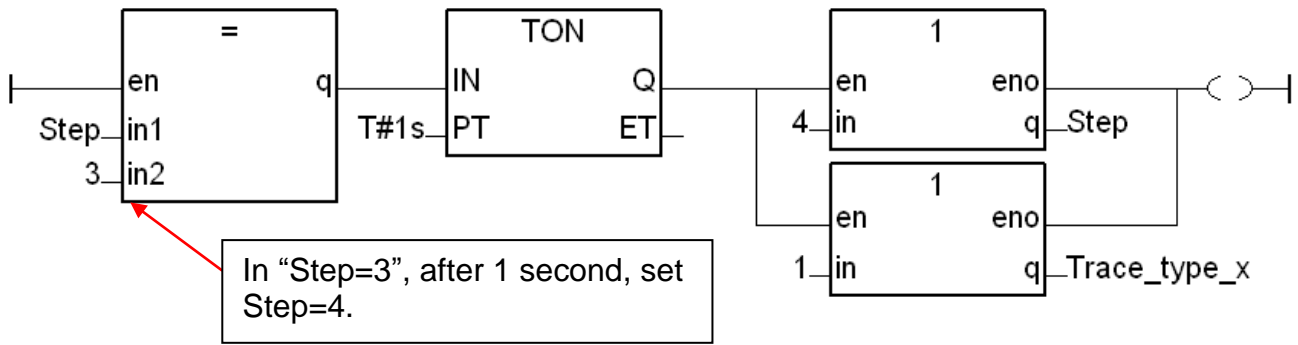

11.3.2 Set up I/O connection :

Step 1 : Click [Project] > [I/O connection] or the tool icon to open the setting window. Select "Equipments" and then select "I_8094f: for I-8094F or I-8094" I/O module.

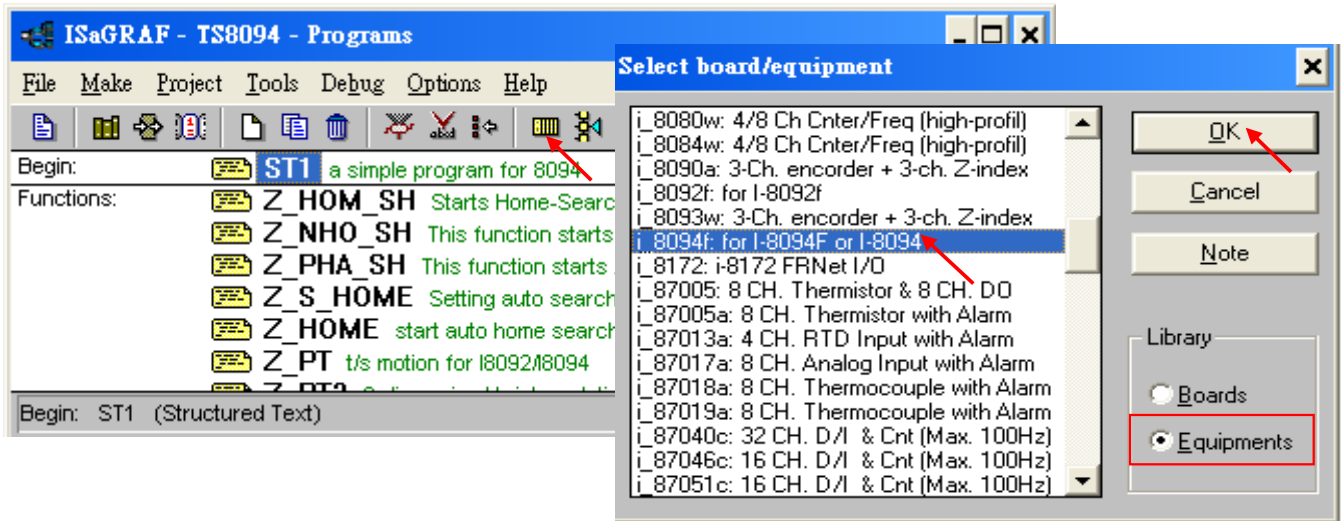

Step 2 : Set up the parameters and variables for I/O connection. For this example, setup the "ALL_DI", "X_DI" and "ENCO".

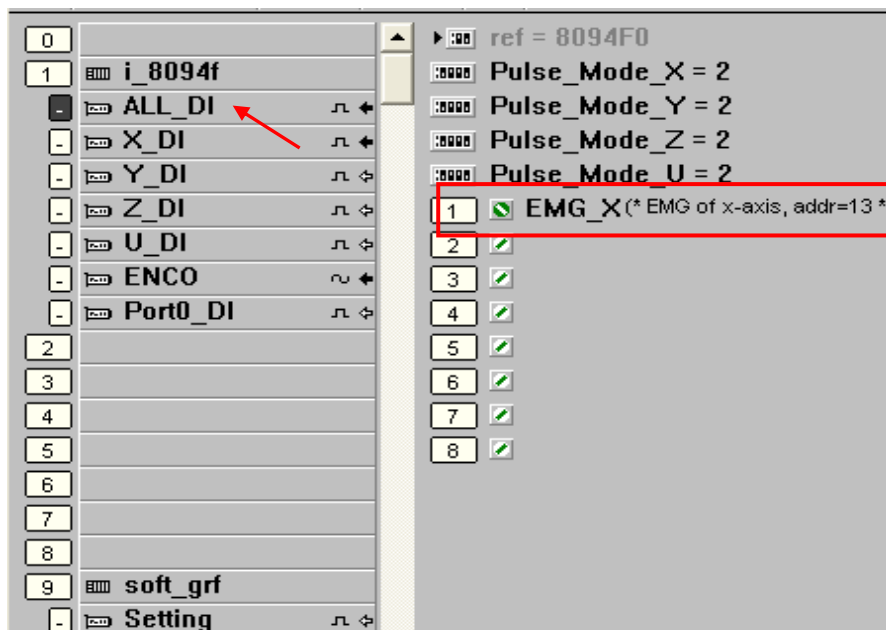

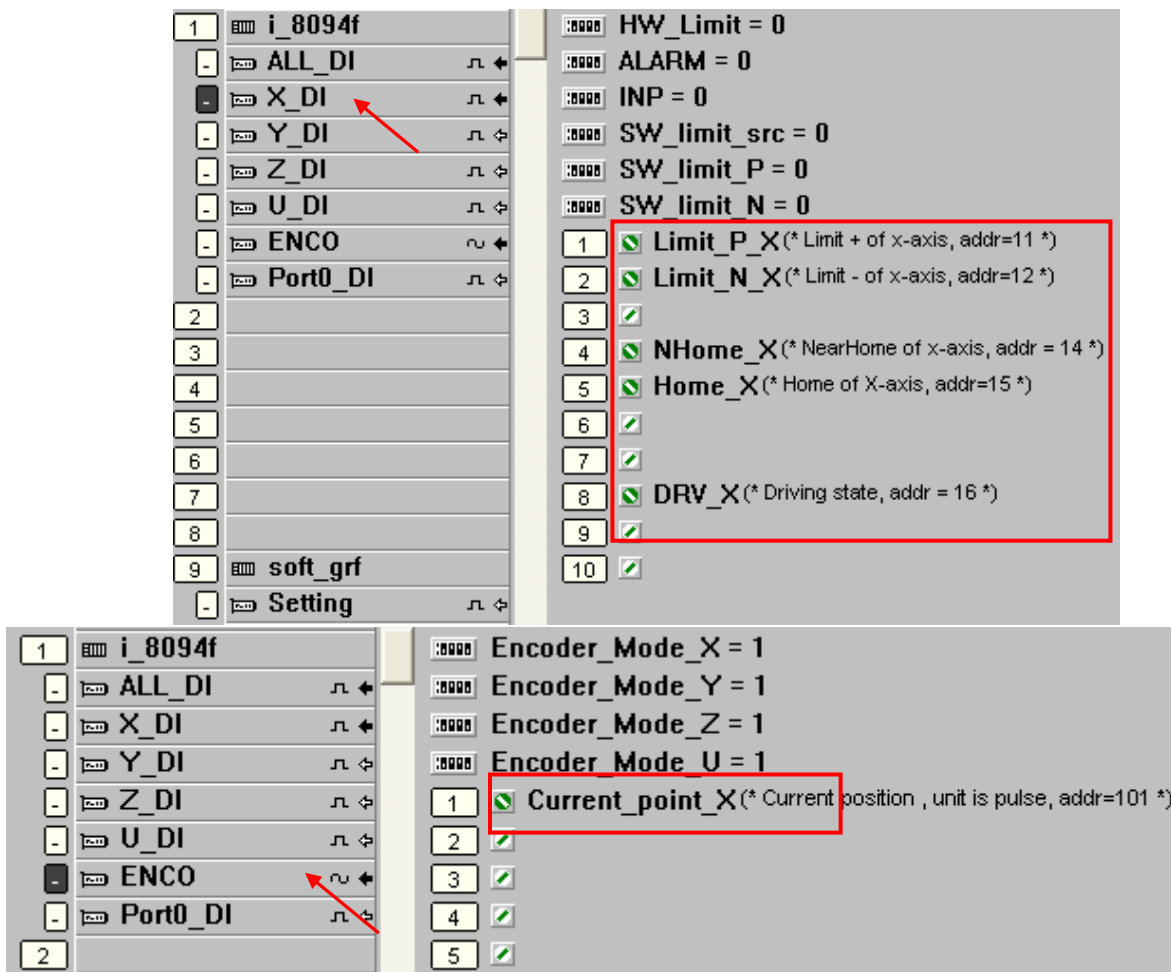

11.3.3 Compile, Download and execute the project :

Step1. Set up compiler Options: click [Make] > [Compiler options]

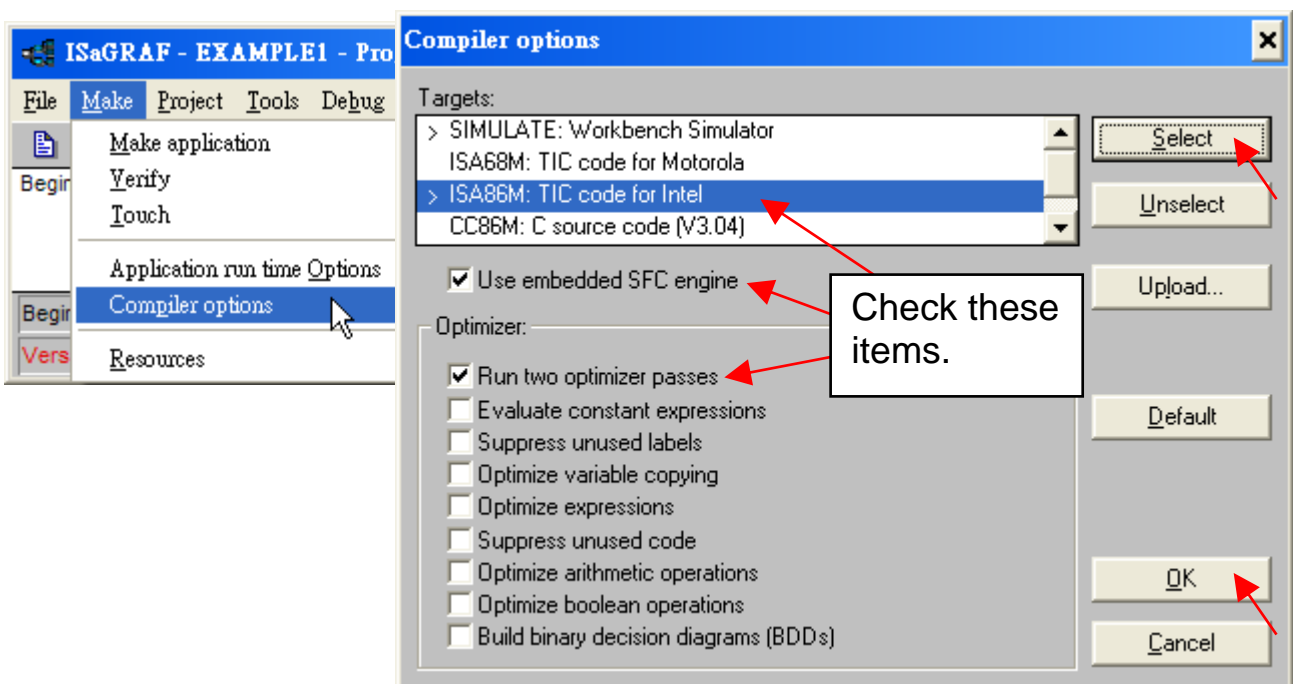

Step 2 : Compile & download: Click [Make] > [Make Application] , then download the project into XPAC in the [Debug] mode.

Step 3 : Execute: Double click “start”, select “True”, and notice the variables’ value changing.

Name	Value	Comment
Step	0	
Current_point_X	0	
Start	FALSE	
Mov_Speed_X	5000	
Next_Point_X	0	
Move_it	FALSE	
Limit_N_X	FALSE	
Limit_P_X	FALSE	
EMG_X	FALSE	
NHome_X	FALSE	
Home_X	FALSE	
DRV_X	FALSE	
Error_code	-1	
Ack_Error	FALSE	

<end of list>

Write boolean variable

variable Start

0 1

Home of X-axis, addr=15
Driving state, addr = 16
If value < 0 means "Error"
Ack Error, addr=4

Step4: Test: Double click “Next_Point_X”, enter the next position to move to. Double click “Mov_Speed_X”, enter the move speed. Double click “Move_it” and select “True” to start motion.

Name	Value	Comment
Step	0	0: Sleep, 1: Home, ... , init
Current_point_X	0	Current position , unit is p
Start	FALSE	Set True to start motion, e
Mov_Speed_X	5000	Move speed, init as 5000, e
Next_Point_X	0	Next position to move to, i

<end of list>

Write integer/real variable

variable Next_Point_X

Enter new value:

Write integer/real variable

variable Mov_Speed_X

Enter new value:

Name	Value	Comment
Step	0	0: Sleep, 1: Home, ... , init
Current_point_X	0	Current position , unit is p
Start	FALSE	Set True to start motion, e
Mov_Speed_X	5000	Move speed, init as 5000
Next_Point_X	100000	Next position to move to, n
Move_it	FALSE	Set True to Move to the n

<end of list>

Write boolean variable

variable Move_it

0 1

11.4 Descriptions for the Setting of I/O Connection

We use the I-8094F module as an example to illustrate the motion settings of I/O connection. Differ from the I-8094F, the 2-axis motion module I-8092F has the settings about X-axis and Y-axis only, without the settings about Z-axis and U-axis.

ALL_DI

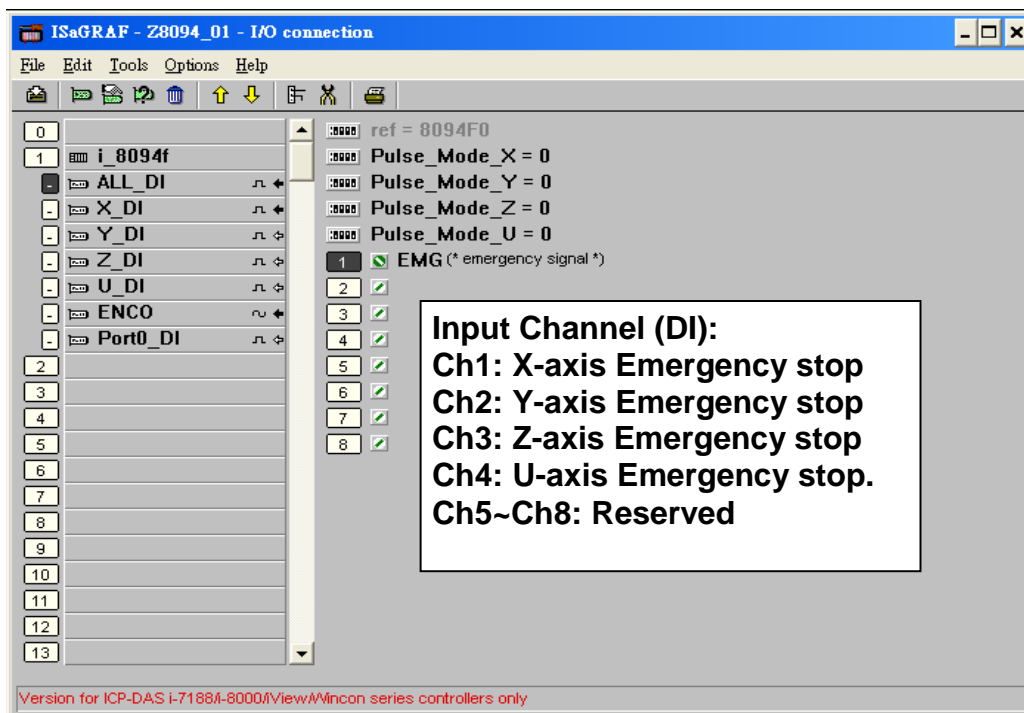

Pulse_Mode_X: Set the X-axis pulse output mode

Pulse_Mode_Y: Set the Y-axis pulse output mode

Pulse_Mode_Z: Set the Z-axis pulse output mode

Pulse_Mode_U: Set the U-axis pulse output mode

0 : CW/CCW (Active Low); The default setting.

1 : CW/CCW (Active High)

2 : Pulse (Active High) / Dir+ (Active Low)

3 : Pulse (Active Low) / Dir.+ (Active Low)

4 : Pulse (Active High) / Dir.+ (Active High)

5 : Pulse (Active Low) / Dir.+ (Active High) ◦

X_DI, Y_DI, Z_DI, U_DI :

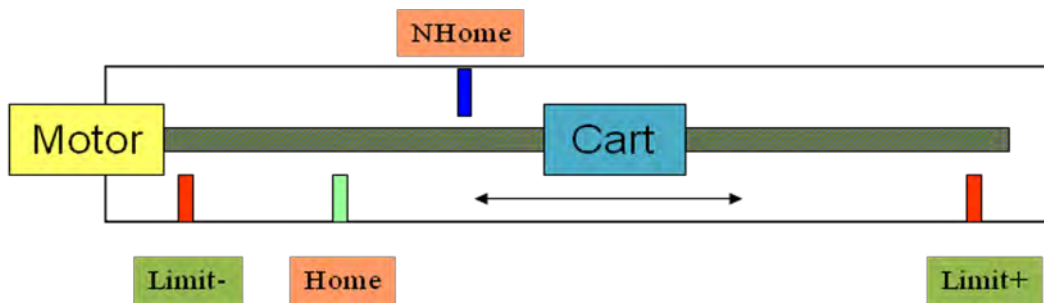

ISaGRAF - Z8094_01 - I/O connection

File Edit Tools Options Help

ref = 8094F1

HW_Limit = 0
 ALARM = 0
 INP = 0
 SW_limit_P = 0
 SW_limit_N = 0

1 Limit_P_X (* Limit-positive switch state of X axis *)
 2 Limit_N_X (* Limit-negative switch state of X axis *)
 3
 4 NearHome_SW (* NearHome switch *)
 5 Home_SW (* Home switch *)
 6
 7
 8
 9
 10

Input channel (DI):
 Ch1 : Limit + Switch
 Ch2 : Limit - Switch
 Ch3 : Alarm Switch
 Ch4 : Near Home Switch
 Ch5 : Home Switch
 Ch6 : In position signal (INP)
 Ch7 : Z-index signal
 Ch8 : Active driving
 Ch9~10: Reserved

Version for ICP-DAS i-7188/I-8000/View/Mncon serie

HW_Limit : Setting the hardware limit positions (Limit+ and Limit-)

0 : Active Low, slowdown stop; The default setting.

1 : Active Low, suddenly stop

2 : Active High, slowdown stop

3 : Active High, suddenly stop

ALARM : Setting the hardware alarm

0: Disable alarm; The default setting.

1: Enable alarm, active Low.

2: Enable alarm, active High.

INP : Setting INP status.

0: Disable INP; The default setting.

1: Enable INP, active low.

2: Enable INP, active high.

SW_limit_P : Setting software Positive Limit position (Limit+, unit: pulse)

0: Disable Limit+; The default setting.

SW_limit_N : Setting software Negative Limit position (Limit-, unit: pulse)

0: Disable Limit-; The default setting.

ENCO :

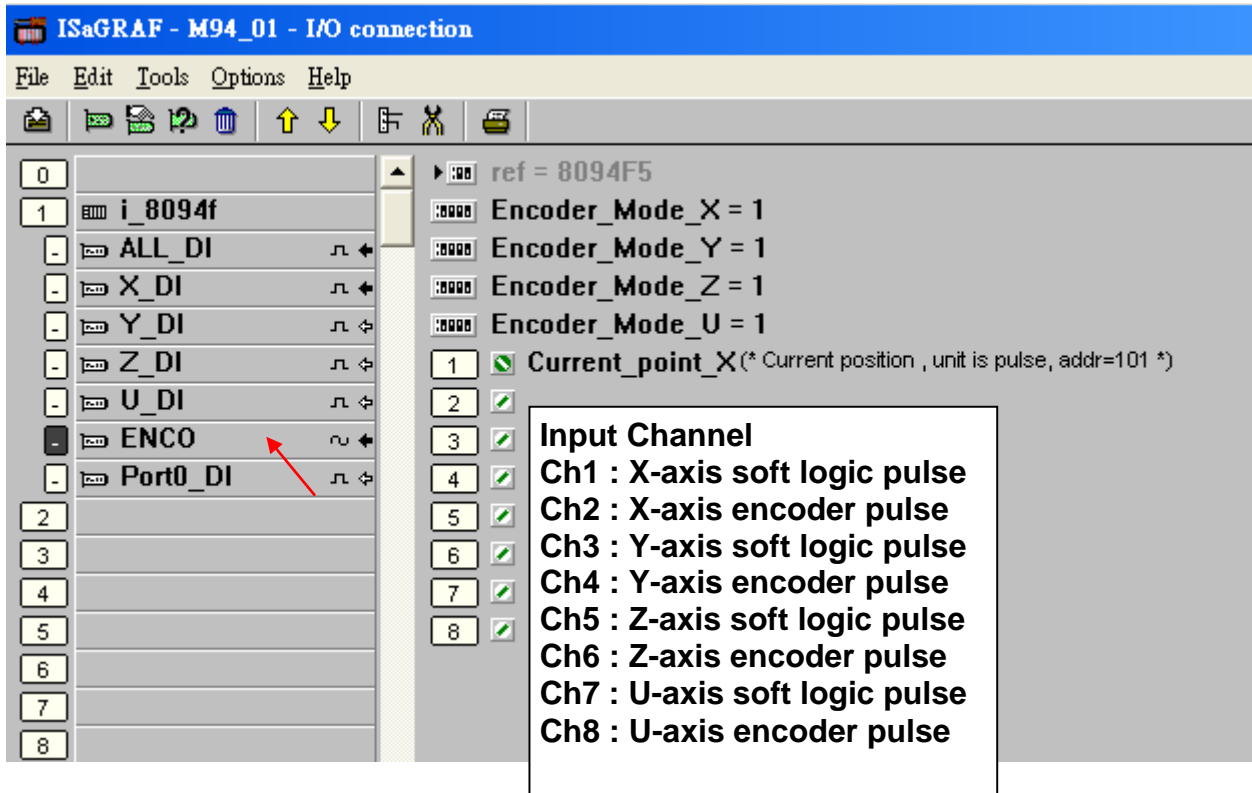

Encoder_Mode_X : Setting X-axis Encoder

Encoder_Mode_Y : Setting Y-axis Encoder

Encoder_Mode_Z : Setting Z-axis Encoder

Encoder_Mode_U : Setting U-axis Encoder

0: CW/CCW mode; The default setting.

1: 1/1 AB phase

2: 1/2 AB phase

4: 1/4 AB phase

Other values: Auto setting to 0: CW/CCW mode.

Port0_DI :

There is one FRnet port in the I-8094F or I-8092F module to connect with the FRnet I/O.

For writing the programs to connect with the FRnet I/O, please refer to FAQ-082 about using "FR_16DO", "FR_16DI" and "FR_B_A" C-function-blocks.

[FAQ-082](http://www.icpdas.com/faq/isagraf/082.htm) : <http://www.icpdas.com/faq/isagraf/082.htm>

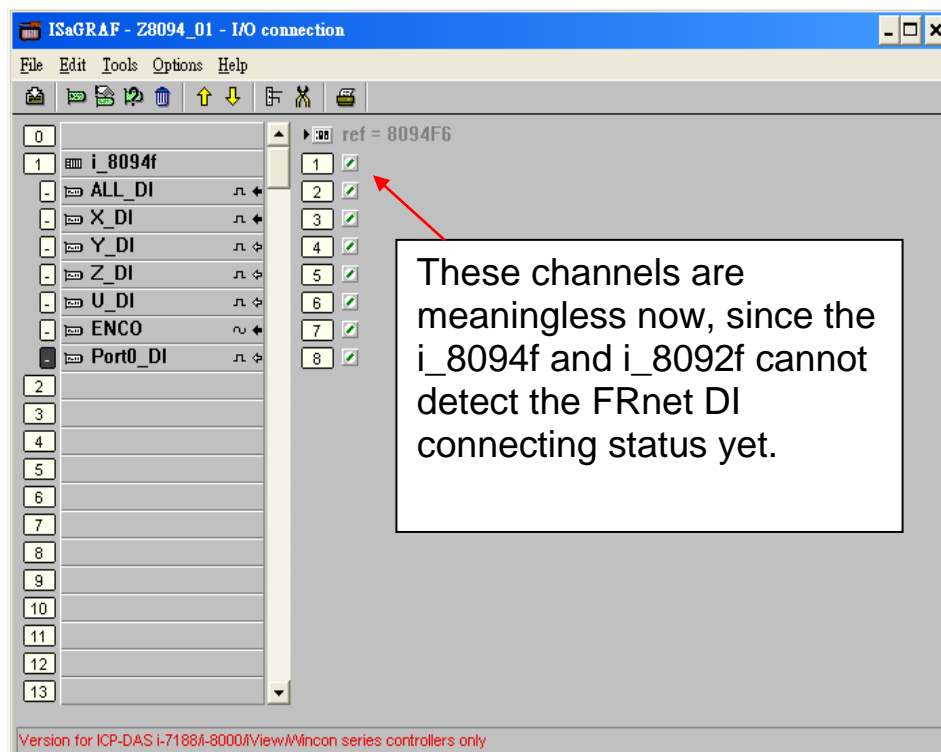

11.5 The Motion Control Programming Steps for ISaGRAF

11.5.1 The Motion Control Steps :

The Motion control programming steps for ISaGRAF are the steps to use the axis cards to control the motor moving. The basic flow chart is as below :

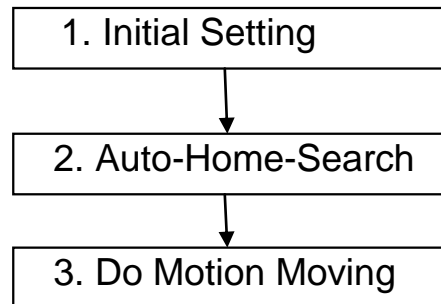

Step 1. Initial Setting :

It includes the initial setting of the range for speed (rate), the hardware active, the Auto-Home-Search, the servo motor etc. In ISaGRAF programming, the **Near Home/NORG**, **Home/ORG** and **Z-index** are set in the motion functions and the other hardware settings are set in the I/O connection.

The initial setting functions :

Function Usage	I-8092F	I-8094F / I-8094
Speed (rate) range initial setting	Z_S_RANG()	
Auto-Home-Search initial setting	Z_S_HOME()	
Servo motor initial setting	Z_SRV_ON()	

Step 2. Auto-Home-Search :

This step will search and check **Near Home**, **Home** and **Z-index** signals automatically before the motion moving. The Z-index may not be searched in this step if it's set not to search the Z-index in the initial setting.

The Auto-Home-Search functions :

Function Usage	I-8092F	I-8094F / I-8094
1. Search Near Home	Z_NHO_SH()	Z_HOME()
2. Check if succeeds	Z_DONE(): return 256	
3. Search Home	Z_HOM_SH()	
4. Check if succeeds	Z_DONE(): return 512	
5. Search Z-index	Z_PHA_SH()	Z_DONE(): return 256
6. Check if succeeds	Z_DONE(): return 1024	

Step 3. Do Motion Moving :

Start to do the motion moving. The I-8094F, for instance, can do the single-axis motion, 2/3-axis interpolation motion, 2-axis circular interpolation...etc.

Motion Moving functions : (Refer to Ch.11.6.2 for more functions)

Function Usage	I-8092F	I-8094F / I-8094
Fixed-pulse (Point-to-point) motion	Z_PT() Z_PT2() ZC_PT2()	Z_PT() Z_PT2() Z_PT3() ZC_PT2() ZC_PT3()
Circular motion	Z_ARC2() ZC_ARC2()	
Speed-mode Motion	Z_CON_MV() Z_VEL_MV()	

Accident Situation :

When the motion is moving, it will be stopped at once if some hardware signals are activated, such as Limit+, Limit- or EMG (emergency) signals.

In the next section, we will explain the ISaGRAF motion steps by the examples written in LD program using I-8092F motion module.

11.5.2 The I-8092F Example: m92_01 program LD1

The motion example uses I-8092F module.

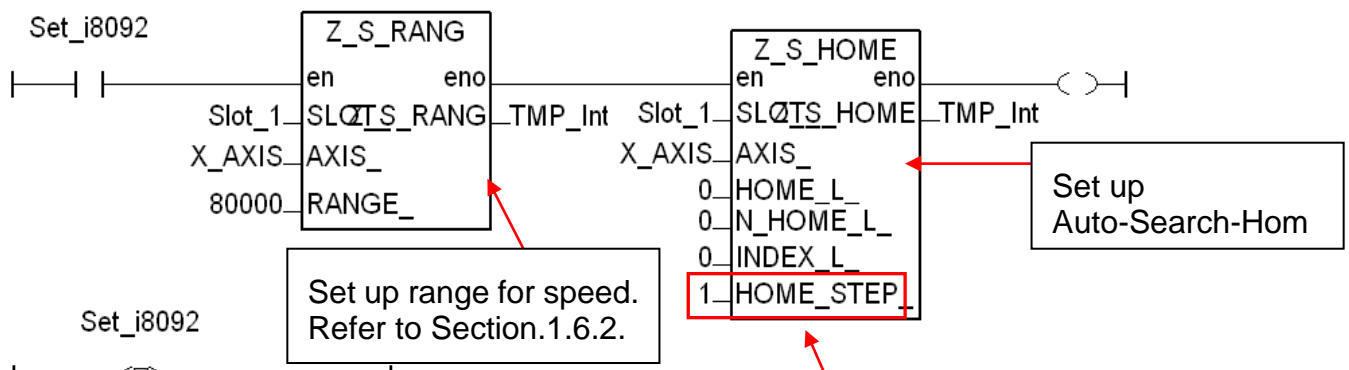
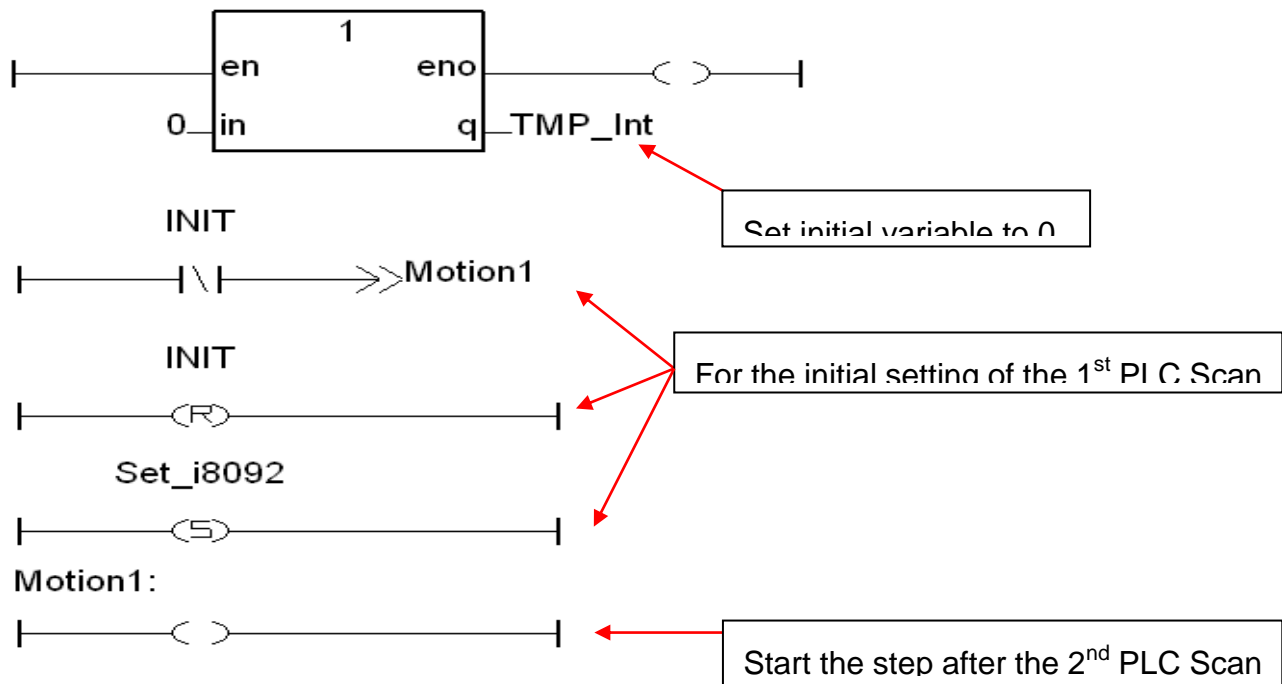

General settings for the Auto-Search -Home:

- 1 : In negative direction: search Near-Home first, and then Home
- 3 : In negative direction: search Near-Home, Home, and then Z-index
- 5 : In negative direction: search Home only
- 7 : In negative direction: search Home, and then X-index

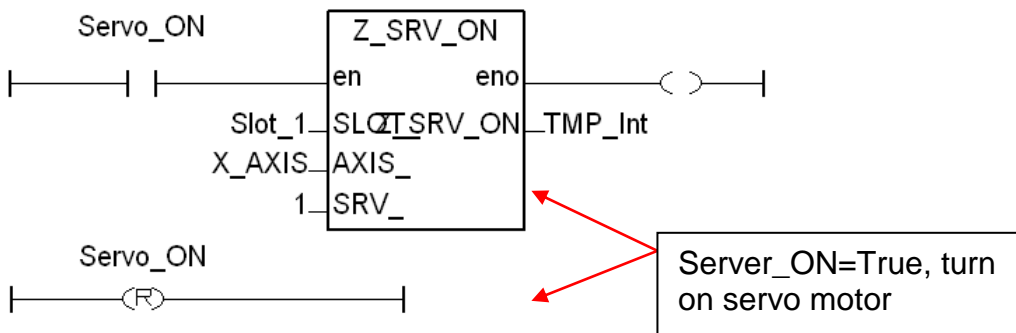

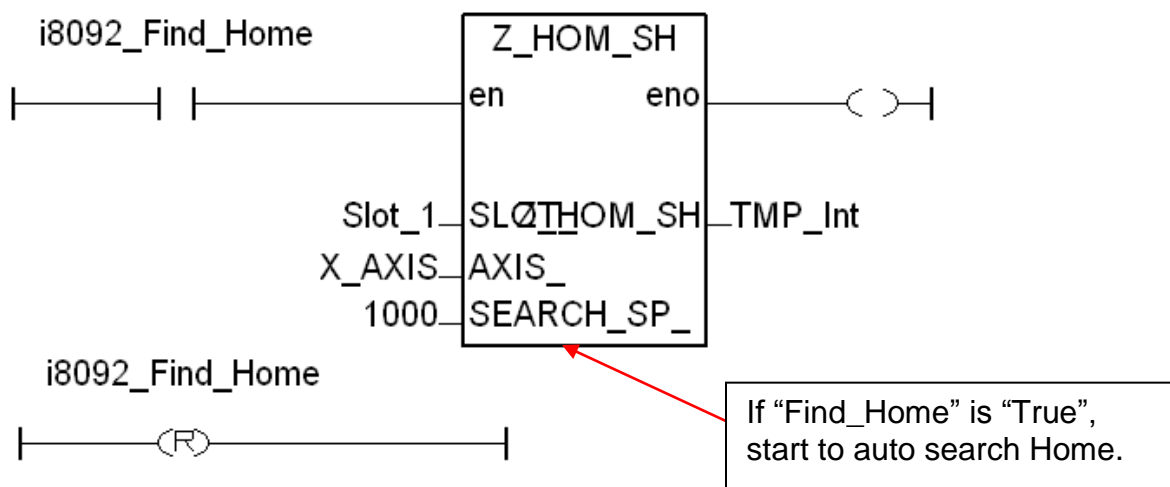
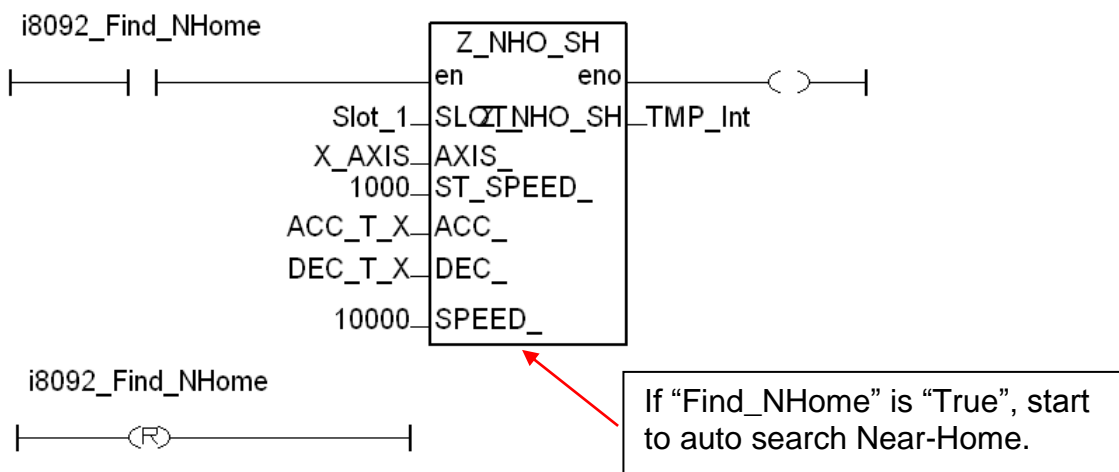
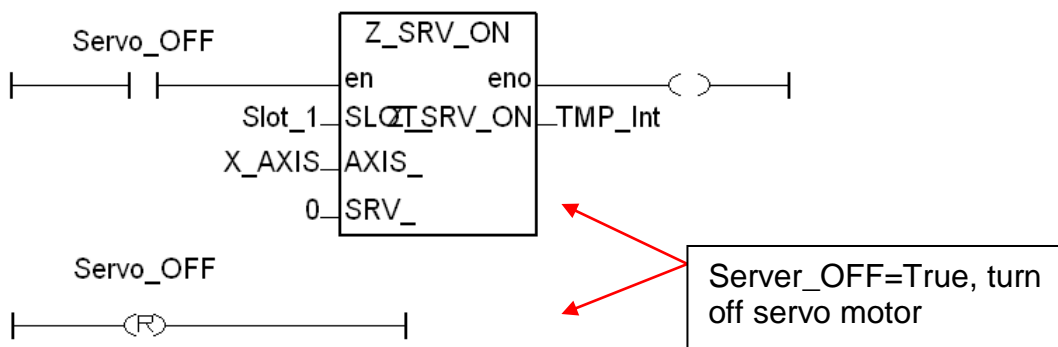

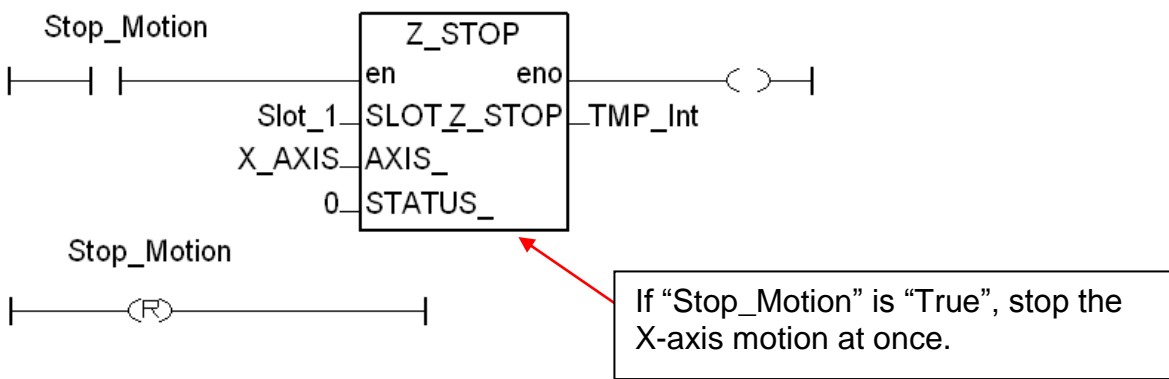
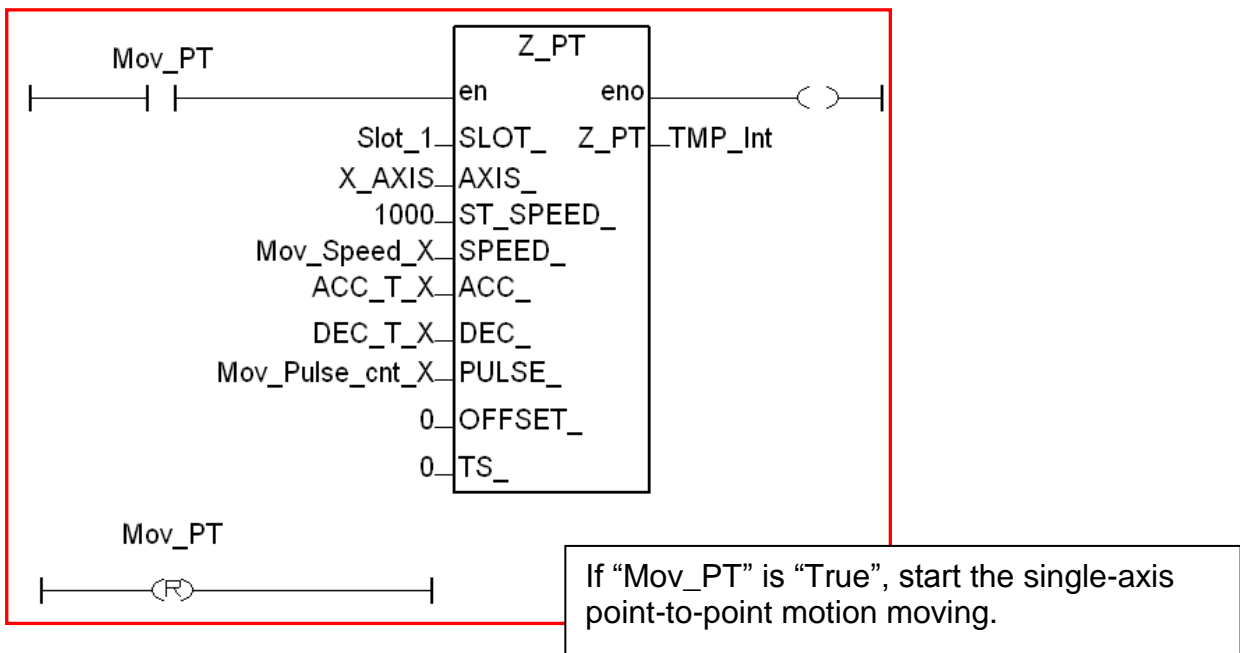
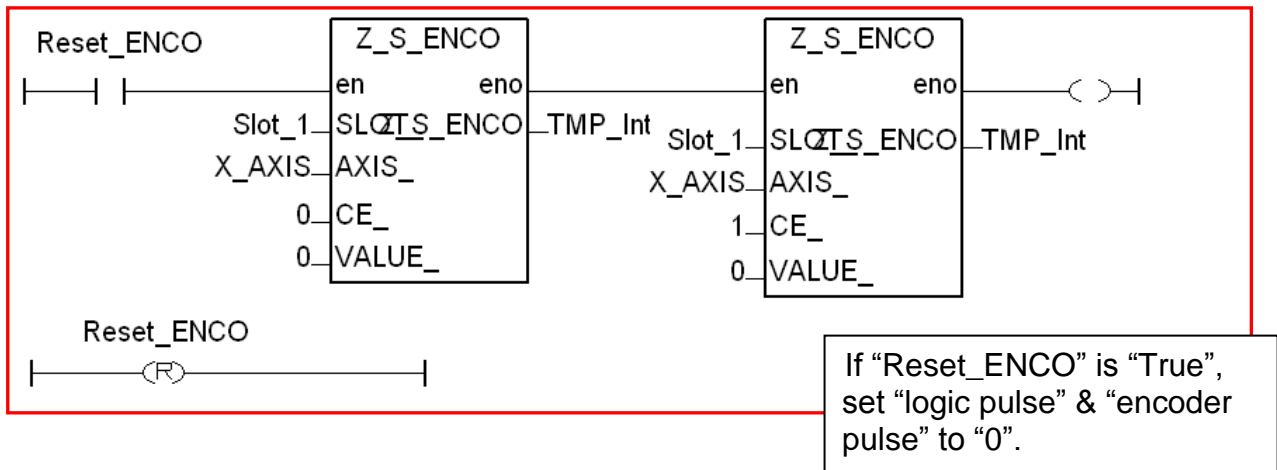

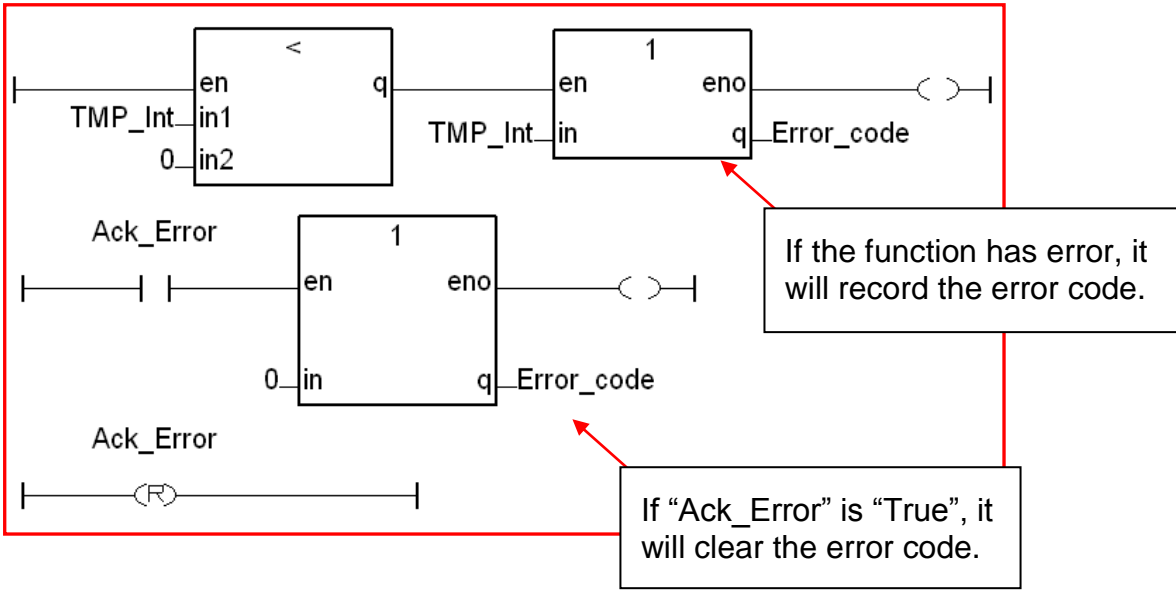

m92_01 Program LD2

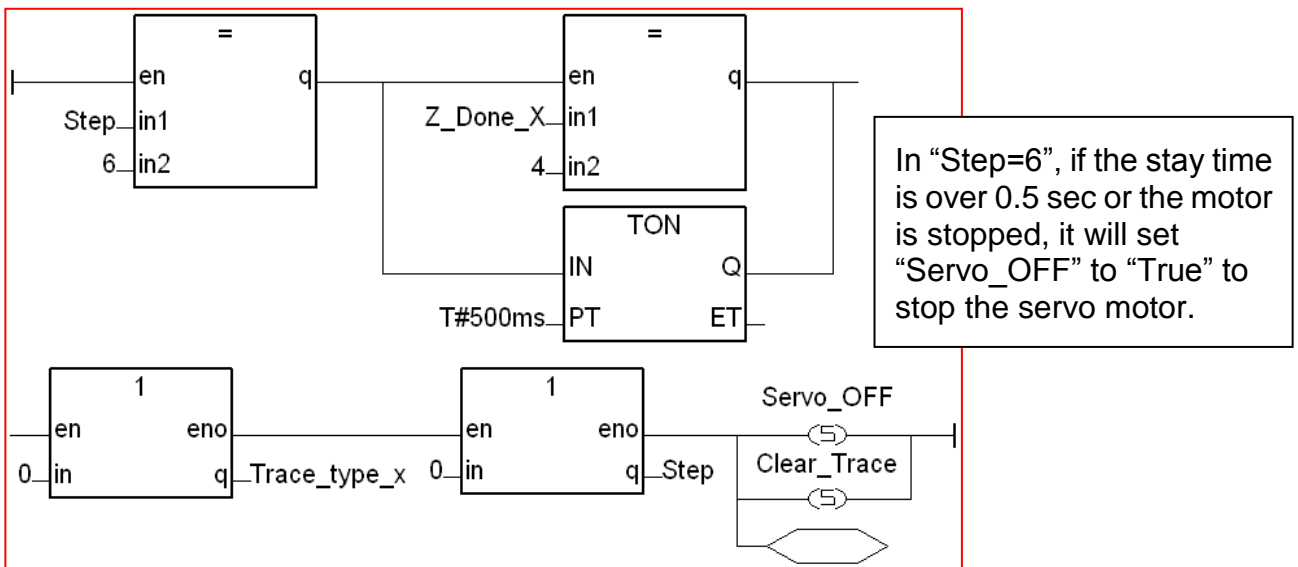
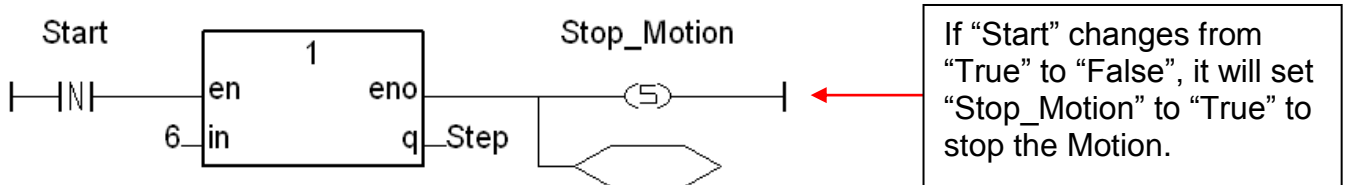
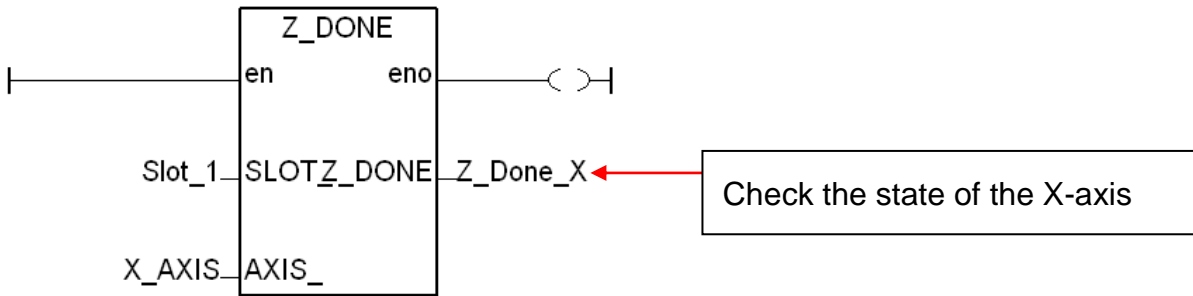

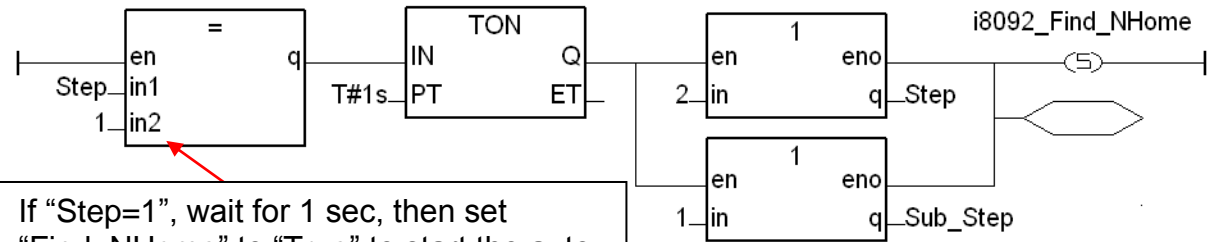
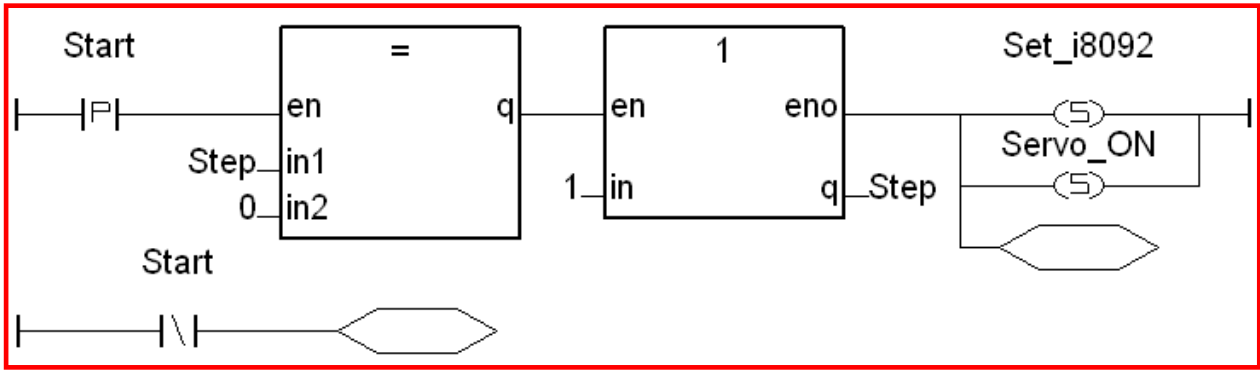

If "Step=1", wait for 1 sec, then set "Find_NHome" to "True" to start the auto search Near-Home in the LD1.

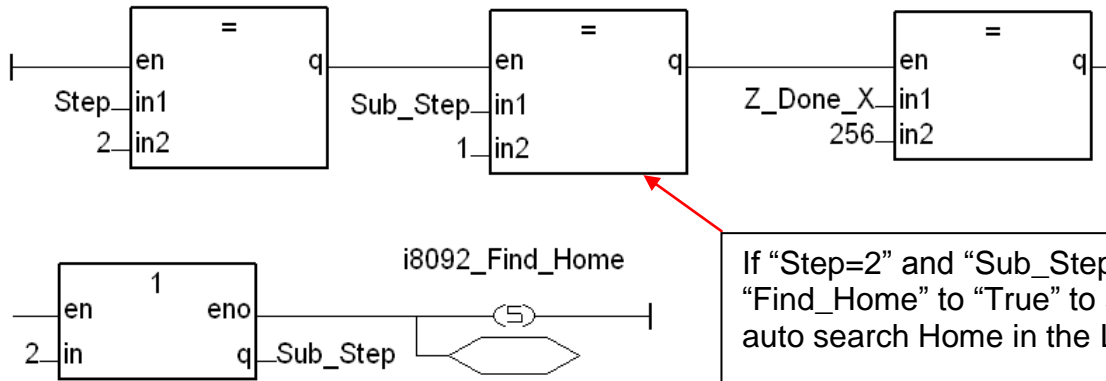

If "Step=2" and "Sub_Step" =1, set "Find_Home" to "True" to start the auto search Home in the LD1.

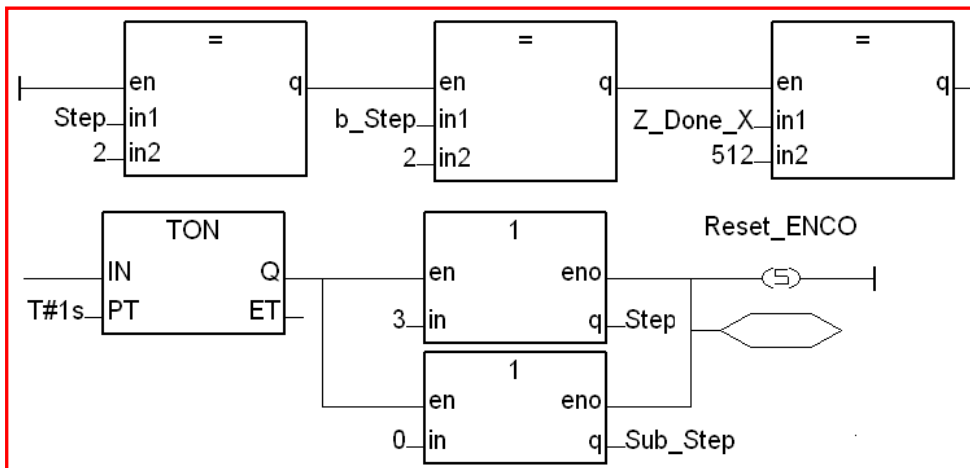

If "Step=2" and "Sub_Step=2", use Z_done() to check if return to the Home position. If Z_Done_X=512, it means Home is found, then reset "logic pulse" & "encoder pulse" to "0".

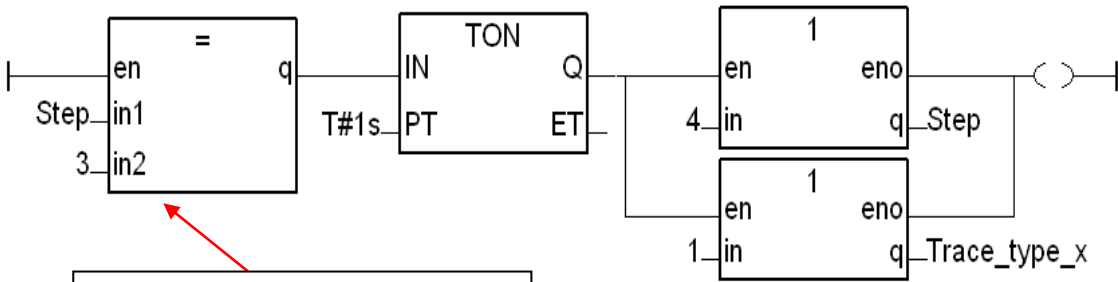

If "Step=3", it means the Auto-Search-Home is done.

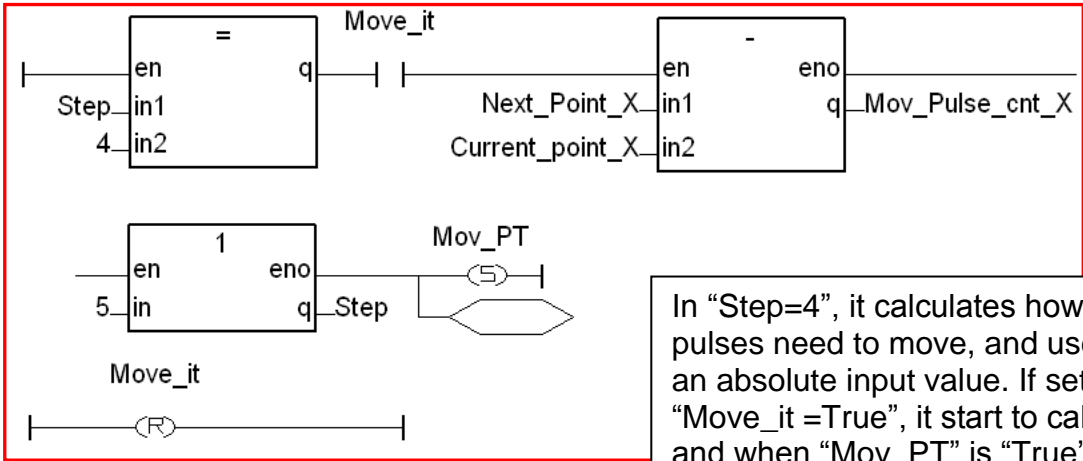

In "Step=4", it calculates how much pulses need to move, and use it as an absolute input value. If set "Move_it =True", it start to calculate, and when "Mov_PT" is "True", it starts to do the point-to-point motion in the LD1.

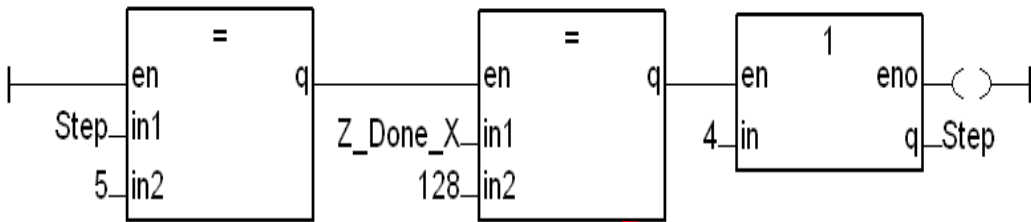

In "Step=5", use Z_done to check if the motion is done. If done, return Z_Done_X=128, and set Step=4. Then return to the previous step.

11.6 ISaGRAF Function Descriptions

11.6.1 Notice in using motion functions :

- In ISaGRAF, programmers often use the motion functions in **Sequential Function** or **Chart Structure Text** language. **If user select the LD or FBD to use the functions, please note not to call the I-8094F/8092F/8094 functions in every PLC scan.**

Note the examples below:

Wrong Using :

Dangerous !!

It calls function "Z_PT" in every PLC Scan.

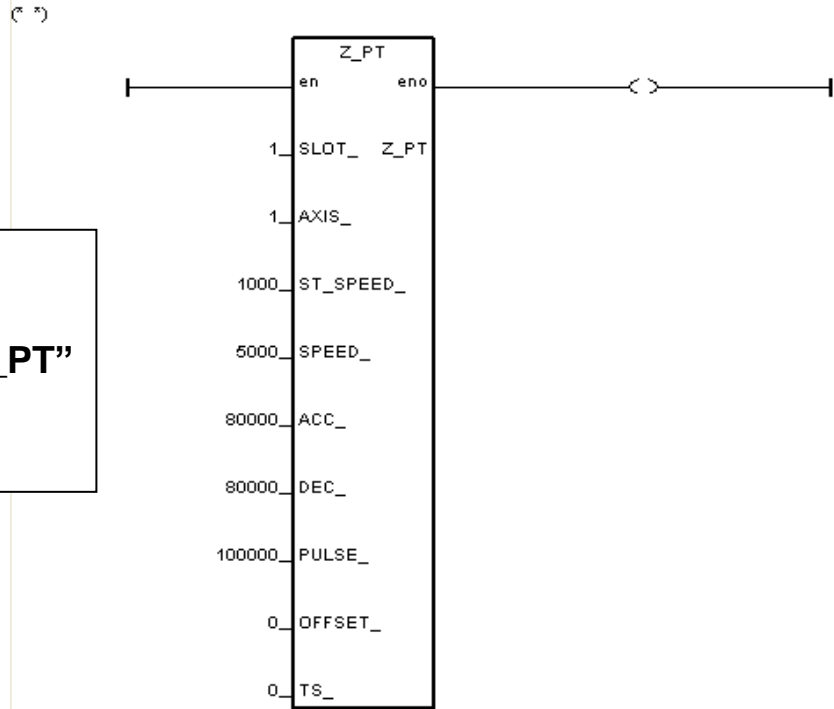

Right Using :

Safe !!

It calls function "Z_PT" once when the "start" is "True".

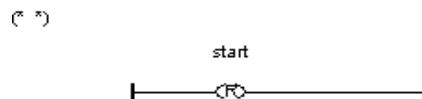
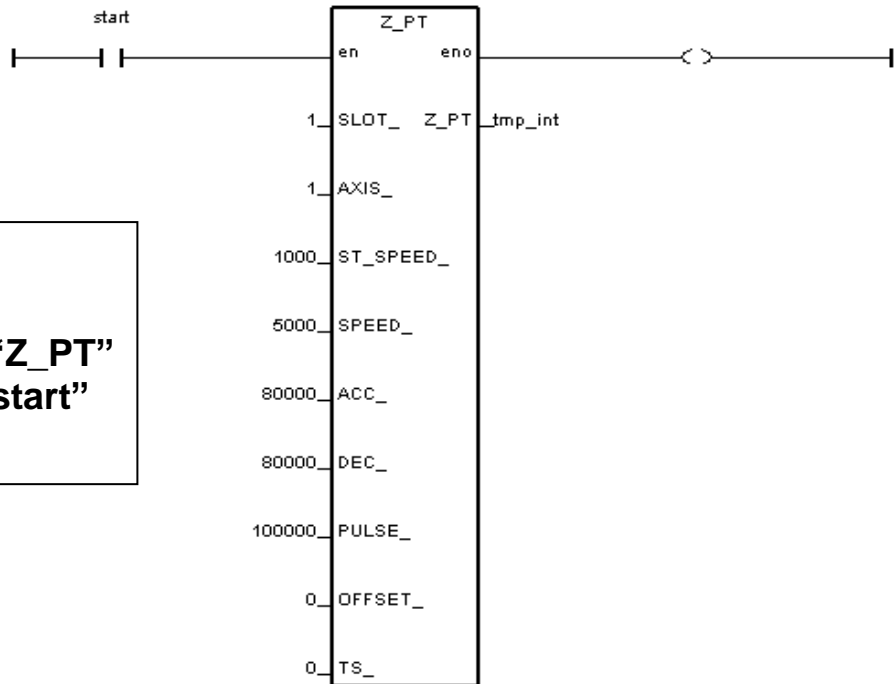

11.6.2 I-8094F / I-8092F / I-8094 Functions:

All parameters and returns of I-8094F/I-8092F/I-8094 functions are **Integer**.

Z_S_RANG : ■ I-8094F ■ I-8092F ■ I-8094

Description : This function changes the *Range* register to change the accuracy and valid-range of speed, acceleration (rate) or deceleration (rate).

Note: Remember to call this function before using motion moving functions. If not, the range_ default setting is 80000. Default ranges:

Range of start speed or drive speed: 100 ~ 800000

Range of acceleration or deceleration: 12500 ~ 100000000

Range of acceleration rate or deceleration rate: 95368 ~ 6250000000
(Max. value for software setting is 2147483647)

Parameters :

SLOT_ : The specific slot number that the motion module installed on.

AXIS_ : Can be one of X-axis, Y-axis, Z-axis or U-axis. (X:1, Y:2, Z:4, U:8)

RANGE_ : The value to be assigned to the Range register (16,000 ~ 8,000,000)
RANGE_ : The R value of “multiple” in the expressions of speed, acceleration, deceleration, acceleration rate and deceleration rate. User can use the PC tool “Set_Range” to set the RANGE_, or give a suitable R value by referring the expressions of the I-8094F/8092F/8094.

Return : 0: OK
Others: Error. Refer to [Ch.11.9](#) for the error message list.

Set_Range Software Tool & the Expressions:

To get “Set_Range.exe”, from XPAC CD: /napdos/isagraf/some_utility/i-8094-8092/ or download at:

ftp://ftp.icpdas.com/pub/cd/xp-8xx7-ce6/napdos/isagraf/some_utility/i-8094-8092/

Run “Set_Range.exe” tool, enter a RANGE_ value in the “Range” column and click “Calculate” to show the ranges of start speed, drive speed, acceleration (rate) and deceleration (rate) that are the valid & safe ranges for the parameters in the motion moving functions. Please set a suitable “RANGE_” value.

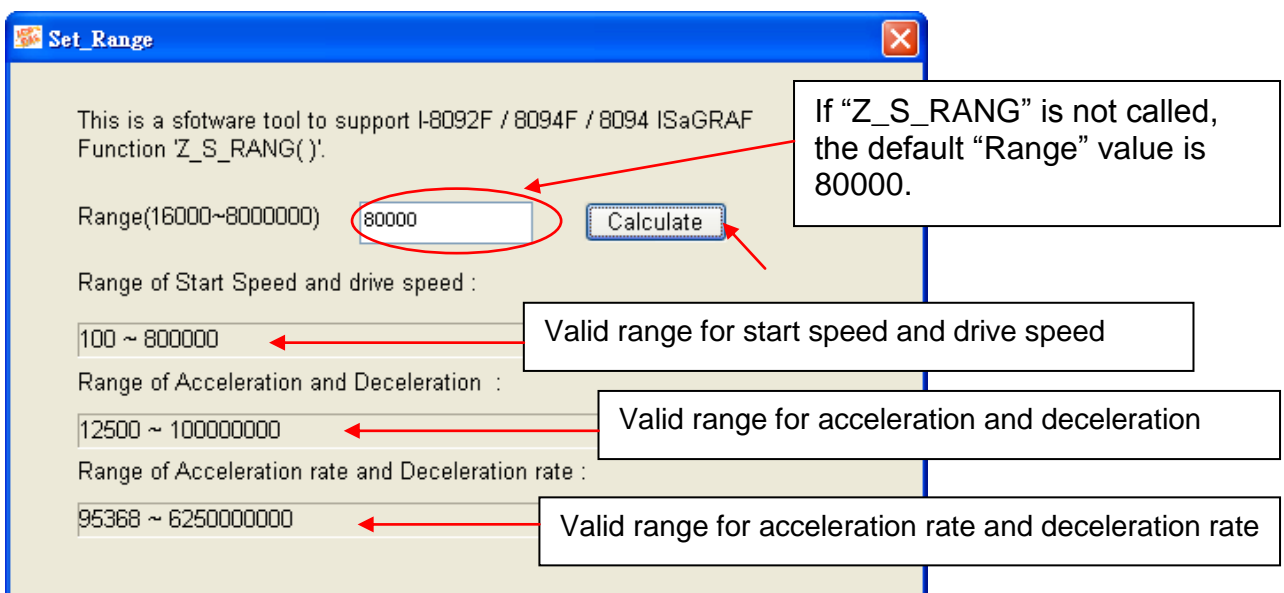

The expressions of I-8094F/I-8092F/I-8094 motion modules to calculate the speed and rate are listed below. Please refer to the module manual for detail information.

$\text{Multiple} = \frac{8,000,000}{R}$	$\text{Deceleration Increasing Rate (PPS/SEC}^2) = \frac{62.5 \times 10^6}{L} \times \frac{8,000,000}{R}$
$\text{Jerk (PPS/SEC}^3) = \frac{62.5 \times 10^6}{K} \times \frac{8,000,000}{R}$	$\text{Deceleration (PPS/SEC)} = D \times 125 \times \frac{8,000,000}{R}$
$\text{Acceleration (PPS/SEC)} = A \times 125 \times \frac{8,000,000}{R}$	$\text{Initial Speed (PPS)} = SV \times \frac{8,000,000}{R}$
$\text{Drive Speed (PPS)} = V \times \frac{8,000,000}{R}$	

The usual words table for the expressions and ISaGRAF functions :

In Expression	In ISaGRAF Function
Multiple	Multiple
R	R value (RANGE_)
Initial Speed	Start speed (ST_SPEED_)
Drive Speed	Drive speed (SPEED_)
Acceleration	Acceleration (ACC_)
Deceleration	Deceleration (DEC_)
Jerk	Acceleration rate (ACC_)
Deceleration Increasing Rate	Deceleration rate (DEC_)
L, K, D, A, SV, V	These values will be transferred into the modules. Users don't need to set in the ISaGRAF, so there are no corresponded words.

Z_S_HOME : ■ I-8094F ■ I-8092F ■ I-8094

Description : This function configures the polarities of Near-Home (NORG), Home (ORG) and Z-index sensors. Also, the searching-steps of Auto-Home-Search are configured in this function.

Parameters :

SLOT_ : The specific slot number that the motion module installed on.

AXIS_ : Can be one of X-axis, Y-axis, Z-axis or U-axis. (X:1, Y:2, Z:4, U:8)

HOME_L_ : Home logic polarity. (0:Active Low; 1:Active High)

N_HOME_L_ : Near Home logic polarity. (0:Active Low; 1:Active High)

INDEX_L_ : Z-index logic polarity. (0:Active Low; 1:Active High)

HOME_STEP_ : The selections for Auto-Home-Search steps:
0 : Do not execute the Auto-Home-Search steps.
1 : In negative direction, trigger Near Home, and then Home.
2 : In positive direction, trigger Near Home, and then Home.
3 : In negative direction, trigger Near Home, Home and then Z-index.
4 : In positive direction, trigger Near Home, Home and then Z-index.
5 : In negative direction, trigger Home only.
6 : In positive direction, trigger Home only.
7 : In negative direction, trigger Home and then Z-index.
8 : In positive direction, trigger Home and then Z-index.

Return : 0: OK
Others: Error. Refer to [Ch.11.9](#) for the error message list.

Z_SRV_ON : ■ I-8094F ■ I-8092F ■ I-8094

Description : This function turns on/off the servo motor.

Parameters :

SLOT_ : The specific slot number that the motion module installed on.

AXIS_ : Can be one of X-axis, Y-axis, Z-axis or U-axis. (X:1, Y:2, Z:4, U:8)

SRV_ : The setting turns on/off the Servo, and sets up how to turn off the servo if the ISaGRAF program stops.
0: Servo off.
1: Servo on, and turn off automatically.
2: Servo on, and turn off manually.

Return : 0: OK
Others: Error. Refer to [Ch.11.9](#) for the error message list.

Z_HOME : I-8094F I-8092F I-8094

Description : This function starts Auto-Home-Search motion with the Start-Speed, Acceleration, Deceleration, Near-Home-Search Speed and Home-Search Speed.

Parameters :

SLOT_ : The specific slot number that the motion module installed on.
AXIS_ : Can be one of X-axis, Y-axis, Z-axis or U-axis. (X:1, Y:2, Z:4, U:8)
S_SPEED_ : The Start Speed in the Auto-Home-Search motion. (Unit: PPS)
ACC_ : The Acceleration in the Auto-Home-Search motion. (Unit: PPS/SEC)
DEC_ : The Deceleration in the Auto-Home-Search motion. (Unit: PPS/SEC)
NH_SPEED_ : The Near-Home Search Speed (Drive Speed) in the Auto-Home-Search motion. (Unit: PPS)
H_SPEED_ : The Home Search Speed in the Auto-Home-Search motion. (Unit: PPS)
This speed is recommended to be lower than the Start Speed.

Return : 0: OK
Others: Error. Refer to [Ch.11.9](#) for the error message list.

Z_DONE : I-8094F I-8092F I-8094

Description : This function checks the completion of motion and returns the cause of motion-completion.

Parameters :

SLOT_ : The specific slot number that the motion module installed on.
AXIS_ : Can be one of X-axis, Y-axis, Z-axis or U-axis. (X:1, Y:2, Z:4, U:8)

Return : 1 : reach software limit in positive direction and stop.
2 : reach software limit in negative direction and stop.
4 : the stop command "Z_STOP" is executed.
128 : complete the fixed-pulse (point-to-point) moving.
256 : I-8094/8094F: complete the Auto-Home-Search moving.
I-8092F: complete the Near-Home(NORG) Search step.
512 : I-8092F complete the Home(ORG) Search step.
1024 : I-8092F complete the Z-index Search step.
4096 : reach hardware limit in positive direction and stop.
8192 : reach hardware limit in positive direction and stop.
16384 : the driving is stopped because the ALARM is enabled.
32768 : the driving is stopped because the Emergency is activated.

Others: Error. Refer to [Ch.11.9](#) for the error message list.

Z_NHO_SH : **I-8094F** **I-8092F** **I-8094**

Description : This function is for I-8092F to start Near-Home-Search moving with the Start speed, Acceleration, Deceleration, Near-Home Searching Speed.

Parameters :

SLOT_ : The specific slot number that the motion module installed on.
AXIS_ : Can be one of X-axis or Y-axis. (X:1, Y:2)
ST_SPEED_ : The Start Speed in Near-Home-Search. (Unit: PPS)
ACC_ : The Acceleration in Near-Home-Search. (Unit: PPS/SEC)
DEC_ : The Deceleration in Near-Home-Search. (Unit: PPS/SEC)
SPEED_ : The Near-Home Search Speed (Drive Speed) in Near-Home-Search. (Unit: PPS)

Return : 0: OK
 Others: Error. Refer to [Ch.11.9](#) for the error message list.

Z_HOM_SH : **I-8094F** **I-8092F** **I-8094**

Description : This function starts Home-Search procedure with the Home (ORG) Searching Speed.

Parameters :

SLOT_ : The specific slot number that the motion module installed on.
AXIS_ : Can be one of X-axis or Y-axis. (X:1, Y:2)
SEARCH_SP_ : The speed of Home (ORG) searching. (Unit: PPS)

Return : 0: OK
 Others: Error. Refer to [Ch.11.9](#) for the error message list.

Z_PHA_SH : I-8094F I-8092F I-8094

Description : This function starts Z-index-Search procedure with the Search_SP Speed.

Parameters :

SLOT_ : The specific slot number that the motion module installed on.

AXIS_ : Can be one of X-axis or Y-axis. (X:1, Y:2)

Search_SP_ : The speed of Z-Phase Searching. (Unit: PPS)

Return : 0: OK
Others: Error. Refer to [Ch.11.9](#) for the error message list.

Z_S_ENCO : I-8094F I-8092F I-8094

Description : This function sets the values in the counter of logic pulse or encoder pulse.

Parameters :

SLOT_ : The specific slot number that the motion module installed on.

AXIS_ : Can be one of X-axis, Y-axis, Z-axis or U-axis. (X:1, Y:2, Z:4, U:8)

CE_ : 0: set up the Logic Pulse; 1: set up the Encoder Pulse

VALUE : The value to be set.

Return : 0: OK
Others: Error. Refer to [Ch.11.9](#) for the error message list.

Z_PT : ■ I-8094F ■ I-8092F ■ I-8094

Description : This function starts the fixed-pulse (point-to-point) motion in the Trapezoidal-profile or S-curve moving.

Parameters :

- SLOT_ : The specific slot number that the motion module installed on.
- AXIS_ : Can be one of X-axis, Y-axis, Z-axis or U-axis. (X:1, Y:2, Z:4, U:8)
- ST_SPEED_ : The Start Speed in trapezoidal-profile and S-curve moving. (Unit: PPS)
- SPEED_ : The Drive Speed in trapezoidal-profile and S-curve moving. (Unit: PPS)
- ACC_ : The Acceleration (Unit: PPS/SEC) in trapezoidal-profile moving. Or The Acceleration Rate (Unit: PPS/SEC²) in S-curve moving. And its Acceleration will be assigned to maximum automatically.
- DEC_ : The Deceleration (Unit: PPS/SEC) in trapezoidal-profile moving. Or The Deceleration Rate (Unit: PPS/SEC²) in S-curve moving. And its Deceleration will be assigned to maximum automatically.
- PULSE_ : The total numbers of output pulse. This parameter is a signed 32-bits variable, the negative value indicates motion in negative direction.
- OFFSET_ : To configure the offset for Acceleration or Deceleration driving. OFFSET_ is optional and default setting is 0. (Unit: Pulse)
- TS_ : 0: Set to Trapezoidal-profile moving
1: Set to S-curve moving

Return : 0: OK
Others: Error. Refer to [Ch.11.9](#) for the error message list.

Trapezoidal-profile moving:

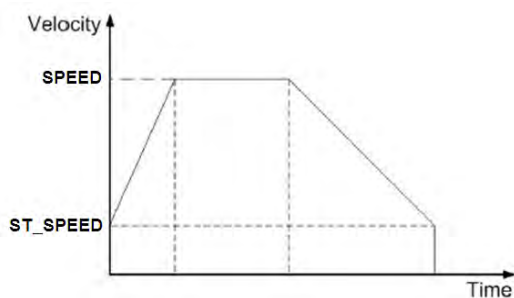

S-curve moving:

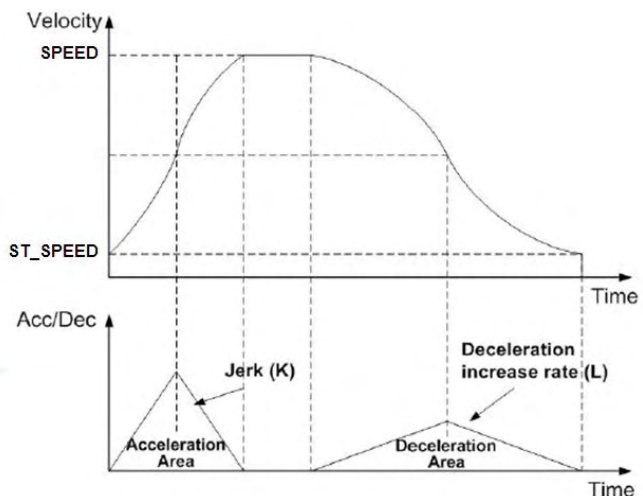

Z_PT2 :

■ I-8094F ■ I-8092F ■ I-8094

Description : This function starts the trapezoidal-profile or S-curve 2-dimension linear interpolation moving. The ST_SPEED_, SPEED_, ACC_ and DEC_ will be applied to the main-axis.

Parameters :

SLOT_ : The specific slot number that the motion module installed on.

MAIN_AXIS_ : Main-axis: one of X-axis, Y-axis, Z-axis or U-axis. (X:1, Y:2, Z:4, U:8)

SLAVE_AXIS_ : Slave-axis: one of X-axis, Y-axis, Z-axis or U-axis. (X:1, Y:2, Z:4, U:8)

Note : Above two parameters must assign to the different axis.

ST_SPEED_ : The Start Speed in trapezoidal-profile and S-curve moving. (Unit: PPS)

SPEED_ : The Drive Speed in trapezoidal-profile and S-curve moving. (Unit: PPS)

ACC_ : The Acceleration (Unit: PPS/SEC) in trapezoidal-profile moving. Or
The Acceleration Rate (Unit: PPS/SEC²) in S-curve moving.

DEC_ : The Deceleration (Unit: PPS/SEC) in trapezoidal-profile moving. Or
The Deceleration Rate (Unit: PPS/SEC²) in S-curve moving.

MAIN_FIN_ : The finish point of main-axis. This parameter is the relative offset to the current position. And the negative value indicates that the finish point is in negative-direction.

SLAVE_FIN_ : The finish point of slave-axis. This parameter is the relative offset to the current position. And the negative value indicates that the finish point is in negative-direction.

OFFSET_ : To configure the offset for Acceleration or Deceleration driving.
OFFSET_ is optional and default setting is 0. (Unit: Pulse)

TS_ : 0: Set to Trapezoidal-profile moving
1: Set to S-curve moving

Return : 0: OK
Others: Error. Refer to [Ch.11.9](#) for the error message list.

Trapezoidal-profile moving:

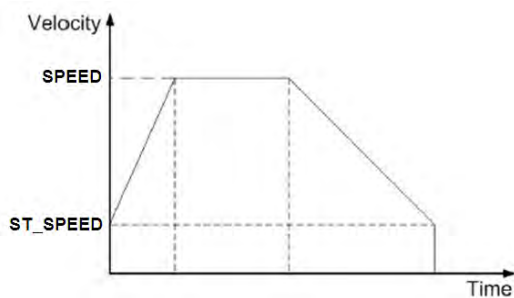

S-curve moving:

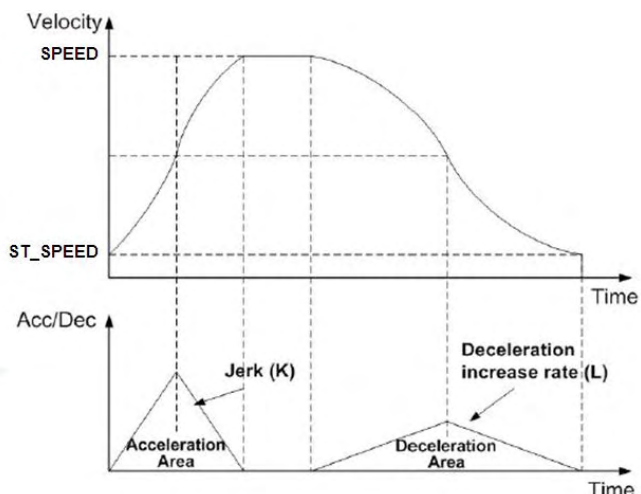

Z_PT3 :

■ I-8094F □ I-8092F ■ I-8094

Description : This function starts the trapezoidal-profile or S-curve 3-dimension linear interpolation moving. The ST_SPEED_, SPEED_, ACC_ and DEC_ will be applied to the main-axis.

Parameters :

SLOT_ : The specific slot number that the motion module installed on.

MAIN_AXIS_ : Main-axis: one of X-axis, Y-axis, Z-axis or U-axis. (X:1, Y:2, Z:4, U:8)

SLAVE_AXIS_ : Slave-axis: one of X-axis, Y-axis, Z-axis or U-axis. (X:1, Y:2, Z:4, U:8)

THIRD_AXIS_ : Third-axis: one of X-axis, Y-axis, Z-axis or U-axis. (X:1, Y:2, Z:4, U:8)

Note : Above three parameters must assign to the different axis.

ST_SPEED_ : The Start Speed in trapezoidal-profile and S-curve moving. (Unit: PPS)

SPEED_ : The Drive Speed in trapezoidal-profile and S-curve moving. (Unit: PPS)

ACC_ : The Acceleration (Unit: PPS/SEC) in trapezoidal-profile moving. Or
The Acceleration Rate (Unit: PPS/SEC²) in S-curve moving.

DEC_ : The Deceleration (Unit: PPS/SEC) in trapezoidal-profile moving. Or
The Deceleration Rate (Unit: PPS/SEC²) in S-curve moving.

MAIN_FIN_ : The finish point of main-axis. This parameter is the relative offset to the current position. And the negative value indicates that the finish point is in negative-direction.

SLAVE_FIN_ : The finish point of slave-axis. This parameter is the relative offset to the current position. And the negative value indicates that the finish point is in negative-direction.

THIRD_FIN_ : The finish point of third-axis. This parameter is the relative offset to the current position. And the negative value indicates that the finish point is in negative-direction.

OFFSET_ : To configure the offset for Acceleration or Deceleration driving. OFFSET_ is optional and default setting is 0. (Unit: Pulse)

TS_ : 0: Set to Trapezoidal-profile moving. 1: Set to S-curve moving

Return :

0: OK

Others: Error. Refer to [Ch.11.9](#) for the error message list.

Trapezoidal-profile moving:

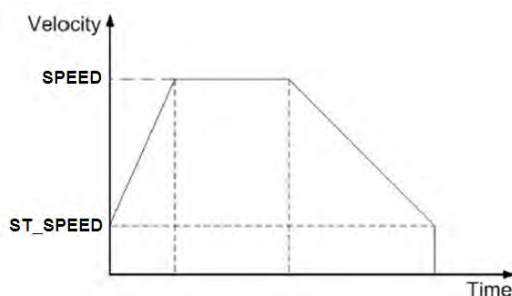

S-curve moving:

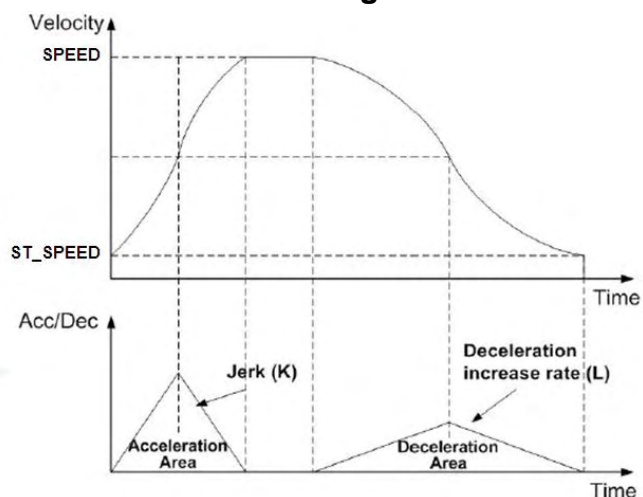

Z_ARC2 :

■ I-8094F ■ I-8092F ■ I-8094

Description :

This function starts the trapezoidal-profile, 2-dimension circular interpolation moving and can only applied to the symmetric trapezoidal Acceleration or Deceleration. The start-point will be the *Origin* of circular-interpolation motion. The **MAIN_CEN_P_** & **SLAVE_CEN_P_** are *center* coordinates related to *Origin*; and **MAIN_FIN_P_** & **SLAVE_FIN_P_** are *finish* coordinates related to *Origin*. The position tolerance for the specified circular curve is ± 1 within the interpolation range. When the value of finish-point reaches the coordinate of *short-axis*, the circular interpolation will be completed. It's showed as below.

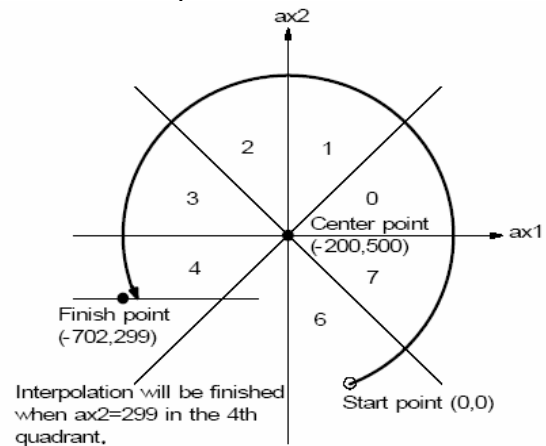

Note:

The ST_SPEED_, SPEED_, ACC_ and DEC_ will be applied to the main-axis.

Parameters :

- SLOT_ : The specific slot number that the motion module installed on.
- AXIS_MAIN_ : Main-axis: one of X-axis, Y-axis, Z-axis or U-axis. (X:1, Y:2, Z:4, U:8)
- AXIS_SLAVE_ : Slave-axis: one of X-axis, Y-axis, Z-axis or U-axis. (X:1, Y:2, Z:4, U:8)

Note : Above two parameters must assign to the different axis.

- ST_SPEED_ : The Start Speed in trapezoidal-profile moving. (Unit: PPS)
- SPEED_ : The Drive Speed in trapezoidal-profile moving. (Unit: PPS)
- ACC_ : The Acceleration (Unit: PPS/SEC) in trapezoidal-profile moving.
- DIR_ : Clockwise or Counter-Clockwise.(0 : Clockwise 1: Counter-Clockwise)
- MAIN_CEN_P_ : The center point of main-axis. This parameter is the relative offset to the current position. And the negative value indicates that the finish point is in negative-direction.
- SLAVE_CEN_P_ : The center point of slave-axis. This parameter is the relative offset to the current position. And the negative value indicates that the finish point is in negative-direction.
- MAIN_FIN_P_ : The finish point of main-axis. This parameter is the relative offset to the current position. And the negative value indicates that the finish point is in negative-direction.
- SLAVE_FIN_P_ : The finish point of slave-axis. This parameter is the relative offset to the current position. And the negative value indicates that the finish point is in negative-direction.

Return :

- 0: OK
- Others: Error. Refer to [Ch.11.9](#) for the error message list.

Z_CON_MV : ■ I-8094F ■ I-8092F ■ I-8094

Description : This function starts constant-speed, fixed-pulse (point-to-point) motion. No acceleration or deceleration is applied in this motion.

Parameters :

SLOT_ : The specific slot number that the motion module installed on.
AXIS_ : Can be one of X-axis, Y-axis, Z-axis or U-axis. (X:1, Y:2, Z:4, U:8)
SPEED_ : The Drive-Speed in constant-speed moving.
PULSE_ : The total numbers (32-bits) of output pulse.
The negative value indicates motion in negative-direction

Return : 0: OK
Others: Error. Refer to [Ch.11.9](#) for the error message list.

Z_VEL_MV : ■ I-8094F ■ I-8092F ■ I-8094

Description : This function starts velocity-move with drive speed continuously. The trapezoidal-profile moving will be applied to Acceleration. Call Z_STOP() to terminate the velocity-move.

Parameters :

SLOT_ : The specific slot number that the motion module installed on.
AXIS_ : Can be one of X-axis, Y-axis, Z-axis or U-axis. (X:1, Y:2, Z:4, U:8)
ST_SPEED_ : The Start Speed in trapezoidal-profile moving. (Unit: PPS)
SPEED_ : The Drive Speed in trapezoidal-profile moving. (Unit: PPS)
ACC_ : The Acceleration in trapezoidal-profile moving. (Unit: PPS/SEC)
DIR_ : 0: Move Direction Positive (Forward)
1: Move Direction Negative (Reverse)

Return : 0: OK
Others: Error. Refer to [Ch.11.9](#) for the error message list.

Z_DRV : ■ I-8094F ■ I-8092F ■ I-8094

Description : This function holds the motion-starting of the involved axes. And these involved axes will start moving simultaneously when HOL_STA_ is equal to 1.

Parameters :

SLOT_ : The specific slot number that the motion module installed on.
AXIS_ : Can be one of X-axis, Y-axis, Z-axis or U-axis. (X:1, Y:2, Z:4, U:8)
HOL_STA_ : 0: drive hold
1: drive start

Return : 0: OK
Others: Error. Refer to [Ch.11.9](#) for the error message list.

Z_STOP : ■ I-8094F ■ I-8092F ■ I-8094

Description : This function stops motion of multiple axes. Please call Z_DONE to make sure that all axes are stopped before starting next motion.

Parameters :

SLOT_ : The specific slot number that the motion module installed on.
AXIS_ : Can be one of X-axis, Y-axis, Z-axis or U-axis. (X:1, Y:2, Z:4, U:8)
STATUS_ : 0 : Slowdown stop
1 : Suddenly stop

Return : 0: OK
Others: Error. Refer to [Ch.11.9](#) for the error message list.

Z_MPG : ■ I-8094F ■ I-8092F ■ I-8094

Description : This function enables and configures the manual-pulse-generator feature. After enabling manual-pulse-generator feature, the constant-speed motion will be started when every pulse is sent from external manual-pulse-generator.

Parameters :

SLOT_ : The specific slot number that the motion module installed on.

AXIS_ : Can be one of X-axis, Y-axis, Z-axis or U-axis. (X:1, Y:2, Z:4, U:8)

CONFIG_ : 0: Disable , 1: AB_PHASE, 2 : CW_CCW

FIX_PULSE_ : Indicates the numbers of pulse will be output when each pulse is sent from manual-pulse-generator.
For instance, assigning 5 to this parameter, 5 pulses will be output when each pulse is sent from external manual-pulse-generator.

CONSTSP_ : The constant-speed of output pulse.

MPGFQ_ : The maximum frequency of the manual-pulse-generator.
Please check the datasheet of manual-pulse-generator.

Return : 0: OK
Others: Error. Refer to [Ch.11.9](#) for the error message list.

Z_GET_SP : ■ I-8094F ■ I-8092F ■ I-8094

Description : This function gets the speed of current motion.

Parameters :

SLOT_ : The specific slot number that the motion module installed on.

AXIS_ : Can be one of X-axis, Y-axis, Z-axis or U-axis. (X:1, Y:2, Z:4, U:8)

Return : 0: OK
Others: Error. Refer to [Ch.11.9](#) for the error message list.

Z_GET_AC : ■ I-8094F ■ I-8092F ■ I-8094

Description : This function gets the acceleration of current motion.

Parameters :

SLOT_ : The specific slot number that the motion module installed on.

AXIS_ : Can be one of X-axis, Y-axis, Z-axis or U-axis. (X:1, Y:2, Z:4, U:8)

Return : 0: OK
Others: Error. Refer to [Ch.11.9](#) for the error message list.

ZC_BEGIN : ■ I-8094F ■ I-8092F ■ I-8094

Description : This function configures the involved axes, the constant vector-speed in continuous interpolation moving.

Parameters :

SLOT_ : The specific slot number that the motion module installed on.

MAXIS_ : The main-axis of interpolation moving.
Can be one of X-axis, Y-axis, Z-axis or U-axis. (X:1,Y:2,Z:4,U:8)

SAXIS_ : The slave-axis of interpolation moving.
Can be one of X-axis, Y-axis, Z-axis or U-axis. (X:1,Y:2,Z:4,U:8)

TAXIS_ : The third-axis of interpolation moving.
Can be one of X-axis, Y-axis, Z-axis or U-axis. (X:1,Y:2,Z:4,U:8)

Note : Above parameters must assign to the different axis.

CONSTSPEED_ : The constant vector-speed in continuous interpolation.
This parameter should be less than 2,000,000 PPS

Return : 0: OK
Others: Error. Refer to [Ch.11.9](#) for the error message list.

Demo files : "M94_03.pia", "M92_03.pia"

ZC_READY : ■ I-8094F ■ I-8092F ■ I-8094

Description : This function checks if the next interpolation segment is ready to be set.

Parameters :

SLOT_ : The specific slot number that the motion module installed on.

Return :
0: the next interpolation segment is not ready to be set.
1: the next interpolation segment is ready to be set.
Others: Error. Refer to [Ch.11.9](#) for the error message list.

Demo files : "M94_03.pia", "M92_03.pia"

ZC_END : ■ I-8094F ■ I-8092F ■ I-8094

Description : This function completes the continuous-interpolation moving, and clears the related configurations kept in driver.

Parameters :

SLOT_ : The specific slot number that the motion module installed on.

Return :
0: OK
Others: Error. Refer to [Ch.11.9](#) for the error message list.

Demo files : "M94_03.pia", "M92_03.pia"

ZC_PT2 : ■ I-8094F ■ I-8092F ■ I-8094

Description : This function starts the constant vector-speed, 2-dimension linear interpolation moving.

Parameters :

SLOT_ : The specific slot number that the motion module installed on.

MFINISH_ : The finish point of main-axis.
This parameter is the relative offset to the current position. And the negative value indicates that the finish point is in reverse-way.

SFINISH_ : The finish point of slave-axis.
This parameter is the relative offset to the current position. And the negative value indicates that the finish point is in reverse-way.

MOVEMODE_ : 0: indicates the "begin" of continuous interpolation moving.
1: the interpolation segment is one part of continuous interpolation moving, and the interrupt of motion checking is involved implicitly.

Return : 0: OK
Others: Error. Refer to [Ch.11.9](#) for the error message list.

Demo files : "M94_03.pia", "M92_03.pia" , "M94_04.pia" , "M94_05.pia"

Warning: Don't call "ZC_PT2" , "ZC_ARC2" and "ZC_PT3" if no movement for the next command. Please wait and call them until the next command has any pulse movement. Please refer to the "STEP5" program of the "m94_05.pia"

ZC_ARC2 : ■ I-8094F ■ I-8092F ■ I-8094

Description : This function starts the constant vector-speed, 2-dimension circular interpolation moving.

Parameters :

SLOT_ : The specific slot number that the motion module installed on.

DIR_ : The direction. 0: Clockwise; 1: Counter-Clockwise

MCENTER_ : The center point of main-axis.
This parameter is the relative offset to the current position. And the negative value indicates that the finish point is in reverse-way.

SCENTER_ : The center point of slave-axis.
This parameter is the relative offset to the current position. And the negative value indicates that the finish point is in reverse-way.

MFINISH_ : The finish point of main-axis.
This parameter is the relative offset to the current position. And the negative value indicates that the finish point is in reverse-way.

SFINISH_ : The finish point of slave-axis.
This parameter is the relative offset to the current position. And the negative value indicates that the finish point is in reverse-way.

MOVEMODE_ : 0: indicates the "begin" of continuous interpolation moving.
1: the interpolation segment is one part of continuous interpolation moving, and the interrupt of motion checking is involved implicitly.

Return : 0: OK
Others: Error. Refer to [Ch.11.9](#) for the error message list.

Demo files : "M94_03.pia", "M92_03.pia", "M94_04.pia", "M94_05.pia"

Warning: Don't call "ZC_PT2", "ZC_ARC2" and "ZC_PT3" if no movement for the next command. Please wait and call them until the next command has any pulse movement. Please refer to the "STEP5" program of the "m94_05.pia"

11.7 Motion Demo Programs

11.7.1 The List of ISaGRAF Motion Demos with Soft-GRAF HMI

The demos can be found in the XP-8xx7-CE6 CD (since ver. 1.09, 2010/10) :
</napdos/isagraf/xp-8xx7-ce6/demo/>

Or download from the following FTP website :

<ftp://ftp.icpdas.com/pub/cd/xp-8xx7-ce6/napdos/isagraf/xp-8xx7-ce6/demo/>

Or FAQ-132 : <http://www.icpdas.com/faq/isagraf/132.htm>

Program	Description
Samp809	A sample project which contains all motion functions.
M94_01	Use I-8094 card and LD language; Single-axis auto search Near-Home & Home, and do the point-to-point moving.
M94_01a	The same as “M94_01”, but use ST language.
M94_01b	Use I-8094 card and LD language; Single-axis auto search Home, and do the point-to-point moving.
M94_01c	Use I-8094 card and LD language; Single-axis auto search Home, do the point-to-point moving, and the manual-pulse-generator control.
M94_01d	Use I-8094 card and LD language; Single-axis auto search Home, do the point-to-point moving, and the FRnet
M94_02	Use I-8094 card and LD language; 2-axis auto search Near-Home & Home, and do the 2-axis 2-dimension interpolation moving.
M94_02a	The same as “M94_02a”, but use ST language.
M94_02b	Use I-8094 card and LD language; 2-axis auto search Home, and do the 2-axis 2-dimension interpolation moving.
M94_03	Use I-8094 card and LD + ST language; 2-axis auto search Home, do the 2-axis 2-dimension interpolation moving.
M94_04	Use I-8094 card and LD + ST language; 2-axis auto search Home, do the 2-axis 2-dimension interpolation moving and the 3-axis 3-dimension interpolation moving.

Program	Description
M94_05	Use I-8094 card and LD + ST language; 2-axis auto search Home, and read max. 250 (x,y) operating parameters for continuous motion from '\System_disk\Backup_integer_0.txt'.
M94_06	Use I-8094 card and LD + ST language; 2-axis auto search Home, and read more than 250 (x,y) operating parameters for continuous motion from '\System_disk\Backup_integer_0.txt'. Max. 10000 (x,y) operating parameters for this demo.
M92_01	Use I-8092 card and LD language; Single-axis auto search Near-Home & Home, and do the point-to-point moving.
M92_01a	The same as "M92_01", but use ST language.
M92_01b	Use I-8092 card and LD language; Single-axis auto search Home, and do the point-to-point moving.
M92_01c	Use I-8092 card and LD language; Single-axis auto search Home, do the point-to-point moving, and the manual-pulse-generator control.
M92_01d	Use I-8092 card and LD language; Single-axis auto search Home, do the point-to-point moving, and the FRnet.
M92_02	Use I-8092 card and LD language; 2-axis auto search Near-Home & Home, and do the 2-axis 2-dimension interpolation moving.
M92_02a	The same as "M92_02", but use ST language.
M92_02b	Use I-8094 card and LD language; 2-axis auto search Home, and do the 2-axis 2-dimension interpolation moving.
M92_03	Use I-8092 card and LD + ST language; 2-axis auto search Home, do the 2-axis 2-dimension interpolation moving.

Please refer to FAQ-131 for Soft-GRAF information:
www.icpdas.com > ISaGRAF PAC > [FAQ](#) > [FAQ-131](#) .

Example M94_01 :

XP-8xx7-CE6 Motion Demo : M94_01.pia . Pls refer to www.icpdas.com>FAQ>Software>ISaGRAF>132

XP-8xx7-CE6 + Slot 1: I-8094 Demo 01 (1-axis-X). This demo using Pulse_Mode as "2: Pause / Dir" and Encorder Mode as "1: AB phase (Divided by 1)". If your hardware is different, pls change it in the IO connection "i_8094f" .

This demo will find NHome switch first and then find Home switch. If your hardware doesnt have NHome or Home switch, pls modify the "HOME_STEP_" setting in the "Z_S_HOME" block in LD1.

The screenshot shows a motion control interface with the following elements:

- Position Scale:** A horizontal scale from 0 to 120000 with major ticks at 0, 60000, and 120000. A green bar indicates the current position at 0.
- Buttons:** "Start" (grey), "Stop" (grey with red text), "Ack Error" (grey), and "Move it" (grey).
- Speed Control:** "Speed (pulse/sec) : 5000" and "Position (pulse) : 0" with input fields and a "Move it" button.
- Status Indicators:** "Z_Done_X : -1" and a row of six indicators: "Limit- : [black square]", "Limit+ : [black square]", "EMG : [black square]", "NHome : [black square]", "Home : [black square]", "DRV : [black square]".
- Status Bar:** A blue bar at the bottom with the text "Step 0: Sleeping, press [Start] to demo it".

11.8 How to Copy One Single Motion Function

All the functions for I-8094F/8092F/8094 are collected in the “samp809” file. In Section 11.3.1, we show you how to copy the whole function file “samp809” to your new project, now we will show you how to copy one single Motion function to your project. Here, we will copy a function "Z_PT" from the “samp809” to the “ex_8094”.

Step 1 : In the ISaGRAF Workbench, open the function file "samp809".



Step 2 : Select function "Z_PT", click [File] > [copy to other project], then select “ex_8094” to copy the "Z_PT" to the project “ex_8094”. Press “OK”

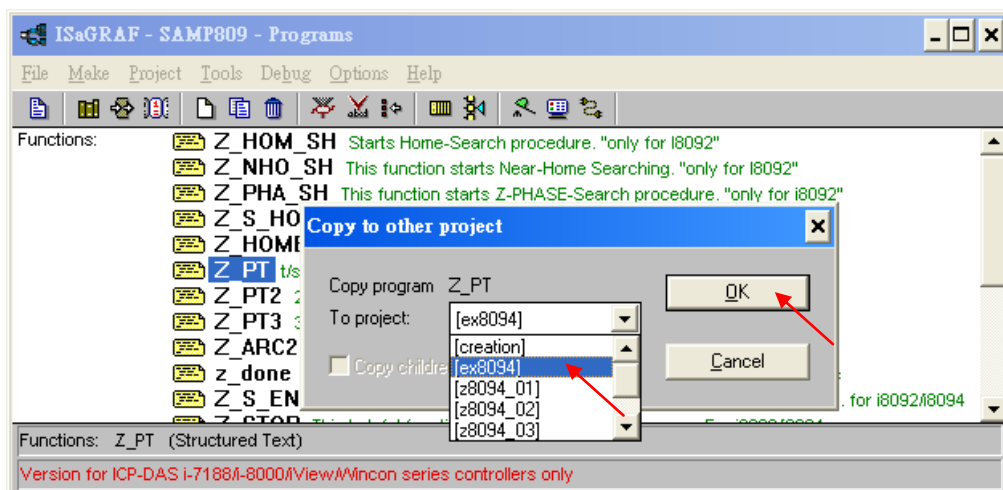
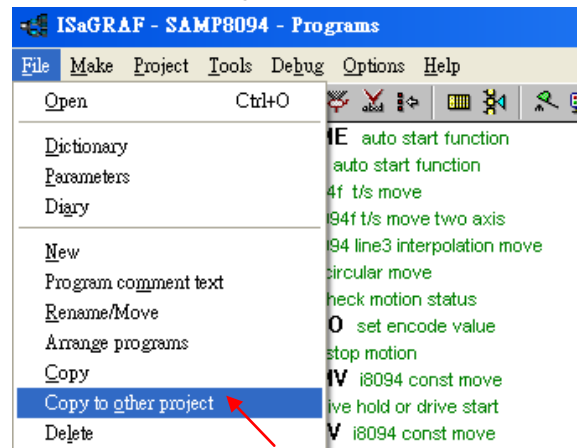
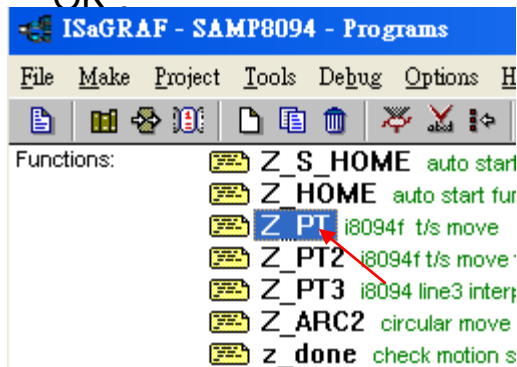

11.9 Error Code List for the Function Return

Error Code List for the Function Return -- I-8092F/8094F/8094

Return Value	Description
-1	Fail to find the correct card in the specific slot or the card has not registered to the RegEdit file.
-102	Fail to open the device-node of I-8092F/8094F/8094. Please make sure no other process occupies that I-8092F/8094F/8094 module.
-103	Fail to close the device-node of I-8092F/8094F/8094.
-104	Cannot reset the Motion-Control ASIC.
-105	Cannot change the content of RANGE_ register
-106	Cannot change the output pulse mode
-107	Cannot change the input encoder mode.
-108	Cannot configure the hardware-limit sensor.
-109	Cannot set the INP configuration.
-110	Cannot set the ALARM configuration
-111	Cannot set the Servo output.
-115	Cannot configure the software-limit settings
-116	Cannot change the configuration of Auto-Home-Search
-118	Cannot start Auto-Home-Search.
-119	Cannot get motion-related digital inputs.
-121	Cannot set the logic-command counter.
-122	Cannot get the logic-command counter.
-123	Cannot set the encoder-position counter.
-124	Cannot get the encoder-position counter.
-125	Cannot get motion status.
-126	Cannot get the current speed.
-127	Cannot get the current acceleration.
-129	Cannot stop current motion.
-131	Cannot start motion of held axes.
-132	Cannot hold the motion-starting.
-133	Cannot enable/configure the variable-ring feature.
-134	Cannot enable/configure the manual-pulse-generator.
-140	Cannot start constant-speed motion
-141	Cannot start trapezoidal moving
-142	Cannot start S-curve moving.
-143	Cannot start trapezoidal 2D interpolation moving.

Return Value	Description
-144	Cannot start trapezoidal 3D interpolation moving.
-145	Cannot start S-curve 2D interpolation moving
-146	Cannot start S-curve 3D linear interpolation moving
-147	Cannot start circular interpolation moving.
-148	Cannot set up the multi-dimension interpolation moving.
-149	Cannot clear the related configurations kept in driver of the continuous interpolation moving.
-150	Cannot get the next-ready status for the next interpolation segment.
-151	Cannot start the constant vector-speed, 2-dimension linear interpolation moving.
-152	Cannot start the constant vector-speed, 3-dimension linear interpolation moving.
-153	Cannot start the constant vector-speed, 2-dimension circular interpolation moving.
-156	Cannot change total number of output pulse.
-201	There is no active i-8094 module on the given slot.
-204	The value to be assigned to RANGE register is invalid.
-210	The value to be assigned to STATUS_ in z_stop() is improperly. (0: slowdown stop, 1: suddenly stop)
-215	The value to be assigned to SRV_ in z_srv_on() is improperly. (0: off, 1: turn on auto-off, 2: turn on manual off)
-223	The value to be assigned to DIR_ in z_vel_mv() is improperly. (:0 forward, 1: reverse)
-224	The value to be assigned to HOME_L_ in z_s_home() is improperly. (0:Active Low, 1:Active High)
-225	The value to be assigned to N_HOME_L_ in z_s_home() is improperly. (0:Active Low , 1:Active High)
-226	The value to be assigned to INDEX_L_ in z_s_home() is improperly. (0:Active Low, 1:Active High)
-227	The value to be assigned to HOME_SET_ in z_s_home() is improperly.
-230	The value to be assigned to CONFIG_ in z_mpg() is improperly. (0 :disable, 1 :AB_PHASE, 2: CW/CCW)
-232	The value to be assigned to H_SPEED_ in z_home() is improperly.
-233	The value assigned to parameter ACC_ is out of range of Acceleration.
-234	The value assigned to parameter DEC_ is out of range of Deceleration.
-235	The value assigned to parameter ACC_ is out of range of Acceleration-Increasing-Rate.
-236	The value assigned to parameter DEC_ is out of range of Deceleration-Increasing-Rate.

Return Value	Description
-244	The value assigned to parameter ST_SPEED is out of range of Speed.
-245	The value assigned to parameter Drive Speed is out of range of Speed.
-247	The Start Speed is larger than Drive Speed .
-248	Multiple axes are assigned to parameter AXIS_ .
-249	No valid axis ID is assigned to parameter AXIS_ .
-250	The parameter Slave Axis includes the axis ID assigned to Main Axis .
-251	The axis ID assigned to Second Axis and Third Axis is the same.
-253	The value to be assigned to DIR_ in z_arc2() is improperly. (0: clock wise, 1:counter clock wise)
-261	The value assigned to parameter CONSTSP_ is out of range of Speed or is less than $2 * \text{MPGFQ}_ * \text{FIXEDPULSE}_$.
-301~ -315	Indicates that some error happens to AXIS X , AXIS Y , AXIS Z or AXIS U .
-324	The Auto-Home-Search had not been configured.
-325	Indicates the previous motion is not completed. Please wait for completion of motion, or stop motion with z_stop() .
-330	The path of circular moving is too small. Please try to increase the circular-path.
-333	The interpolation moving started before had not completed.
-334	The continuous interpolation moving is stopped because the next segment is not ready to be set, user can set MOVEMODE_ to "0" to continue the interpolation moving.
-335	Cannot start the 3-dimension continuous interpolation moving, the setting is for 2-dimension only.
-336	The motion control chip in the I-8094/8092 module does not permit to set the next interpolation segment, please call zc_ready() to check if ready to set.
-338	Indicates the Drive-Speed cannot be applied to S-curve moving.
-339	Indicates the Drive-Speed cannot be changed in non-constant speed area of trapezoidal-profile moving.
-341	Indicates the finish-point of interpolation moving cannot be changed dynamically.
-342	The axes that will to be started are not match to the axes that are held by z_drv() .
-344	Indicates the previous Manual-Pulse-Generator setting is active. Please disable MPG settings with z_mpg() .
-345	Indicates the some axes had been hold, please call z_drv() to release the hold-axes first.
-360	Cannot forward the Axes-checking command to system.
-361	Cannot get the settings of RANGE_ register.

Appendix A Hardware System & Setting

The XP-8xx7-CE6 is the abbreviation of the XP-8047-CE6/8347-CE6/8747-CE6.
The XP-8xx6-CE6 is the abbreviation of the XP-8046-CE6/8346-CE6/8746-CE6.

A.1 Applying Correct Power Supply

Please apply a regular power supply between +10V to +30V (> 35W or larger is better).

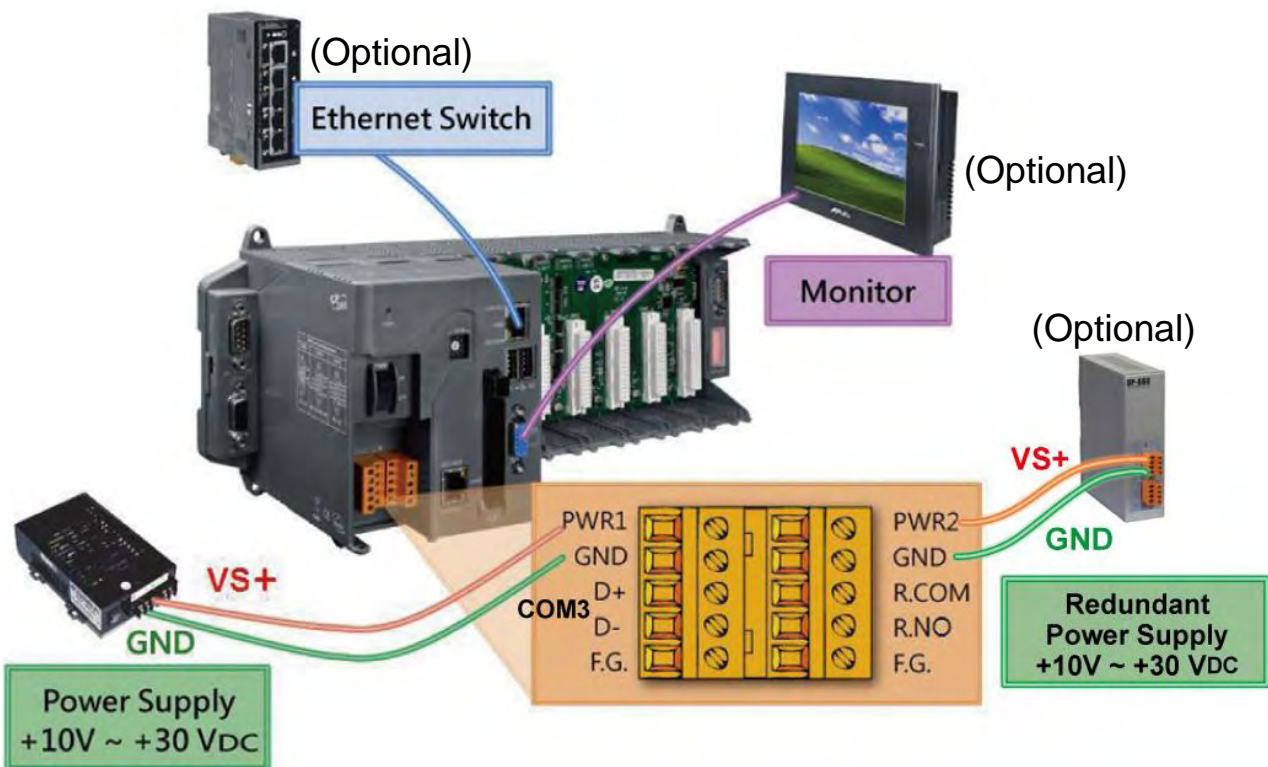

Options:

Power supply:

http://www.icpdas.com/products/Accessories/power_supply/power_list.htm

DP-660 : 24V/2.5A , 5V/0.5A power supply (DIN-Rail mounting)

DP-665 : 24V/2.5A , 5V/0.5A power supply

DP-1200 : 24V/5A power supply

Industrial Ethernet switch:

http://www.icpdas.com/products/Switch/switch_list.htm

NS-205: 10/100M , 5 ports

NS-208: 10/100M , 8 ports

A.2 Modify The NET-ID & Modbus RTU Port Setting

User may set XP-8xx7-CE6's Net-ID (Slave Number) to a No. from 1 to 255.

The default Modbus RTU slave port is "None" when shipped out. User may set it to others depends on the application (Select COM2 or COM3; for setting other ports as Modbus RTU, please refer to appendix G & E).

1. Double click "isaXPce6" icon on the desktop of XPAC.



2. Click [Setting] > [Modify...], set up Slave Number and other Configuration Setting.

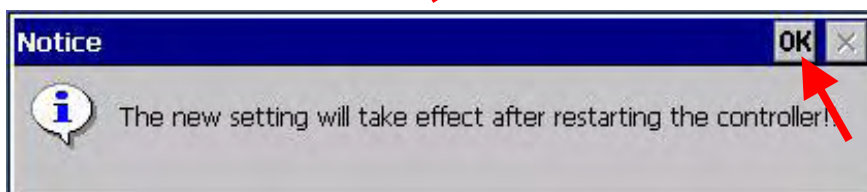
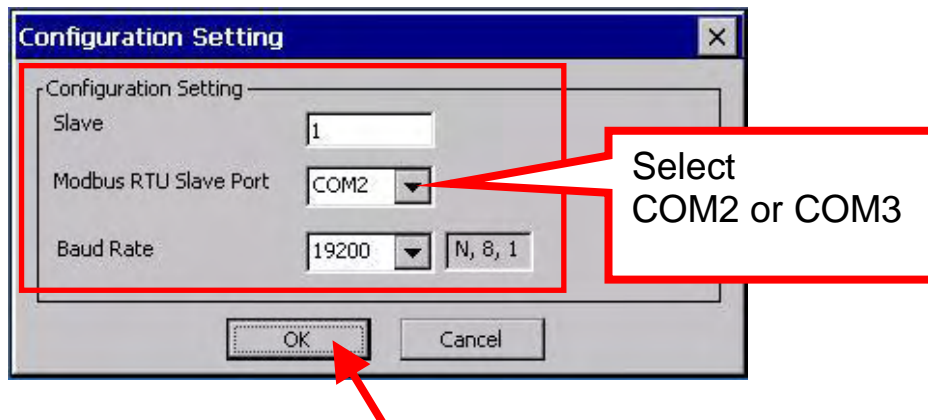
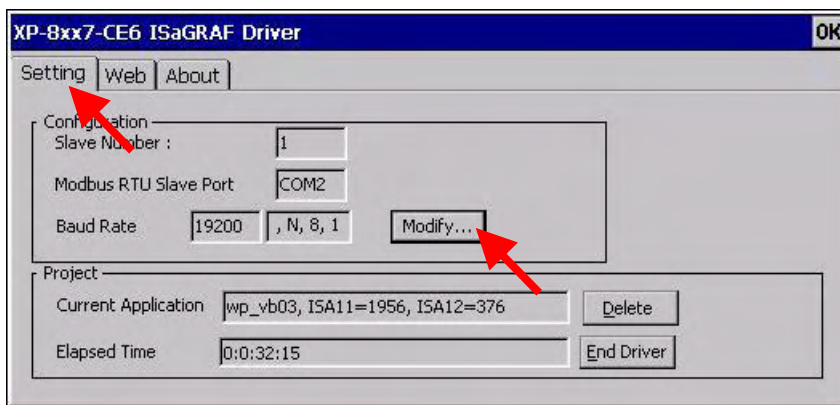

A.3 Setting The IP Address For The XP-8xx7-CE6

Please always set IP as Fixed IP for ISaGRAF application, No DHCP.

1. Click [Start] > [Setting] > [Control Panel] on the desktop of XPAC.
2. Run "Network and Dial-up Connections".
3. Set up the IP Address and Subnet Mask of "LAN1" / "LAN2" on the XPAC.

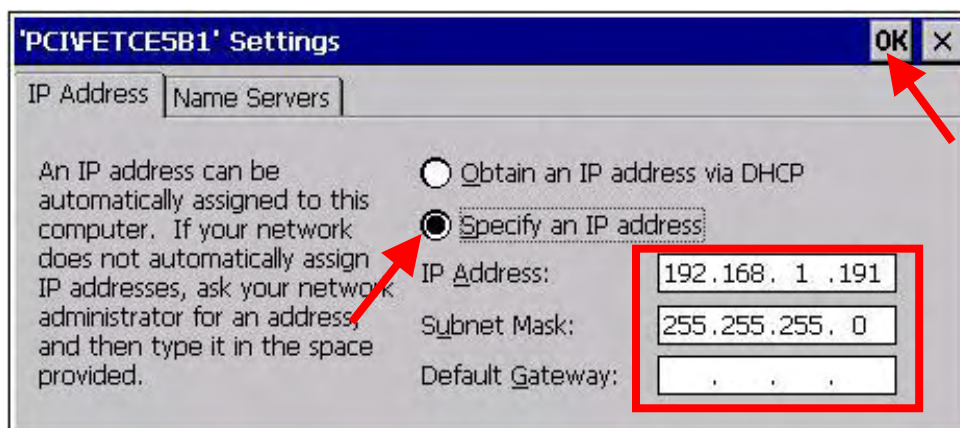
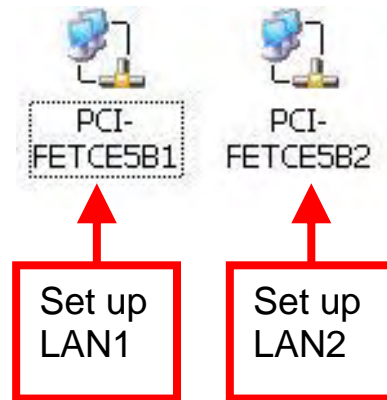

A.4 Connecting PC To The XP-8xx7-CE6 Ethernet Port

Before you can download an ISaGRAF application to the XP-8xx7-CE6 PAC using the Ethernet port, you must first setup the Ethernet port to properly communicate with the PC.

On the XP-8xx7-CE6 :

Set IP, Mask and Gateway address. Please refer to former section A.3.

On your PC:

First open an ISaGRAF project and select a program you wish to communicate between your PC and the XP-8xx7-CE6 controller system.

Next, select the "Link Setup" button on the project screen as shown below.



Select the "Ethernet" communications option in the "PC-PLC Link Parameters" dialog box and click on the "Setup" button.

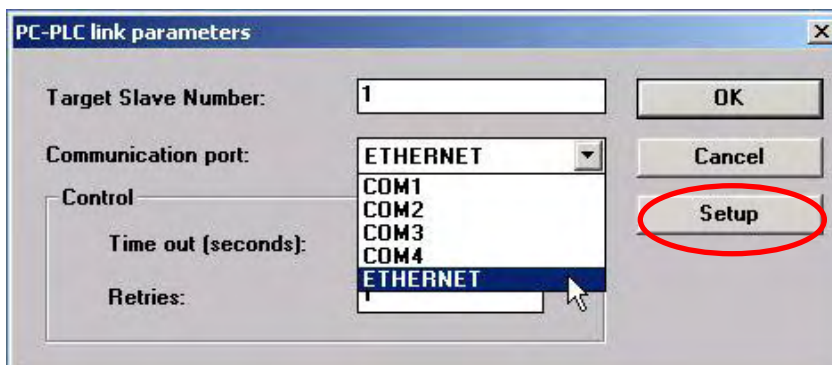

An "Ethernet Link Parameters" dialog box will appear. Set the "Port Number" to "502" and enter in the **Internet address (IP) of the XP-8xx7-CE6 controller.**

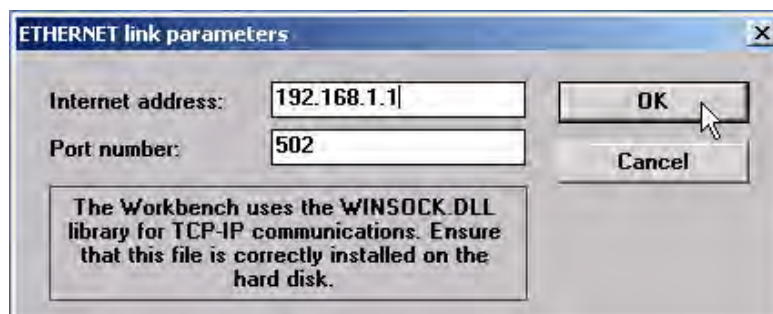

Then, click on the "OK" button.

Now you have configured your PC to communicate with the XP-8xx7-CE6 through the Ethernet port.

A.5 Pin Assignment of COM1~COM5 and Multi-Clients Connection

Each XP-8xx7-CE6 has an IP address and with a fixed Ethernet port No. **502**. Up to 64 PCs can link to one XP-8xx7-CE6 throughout Ethernet (Modbus TCP/IP protocol, one TCP/IP connection for each PC). Other PC/HMI via Modbus RTU Protocol can link to one of COM2,3 (Appendix A.2) or eight of COM1,4~33 (Appendix G & E).

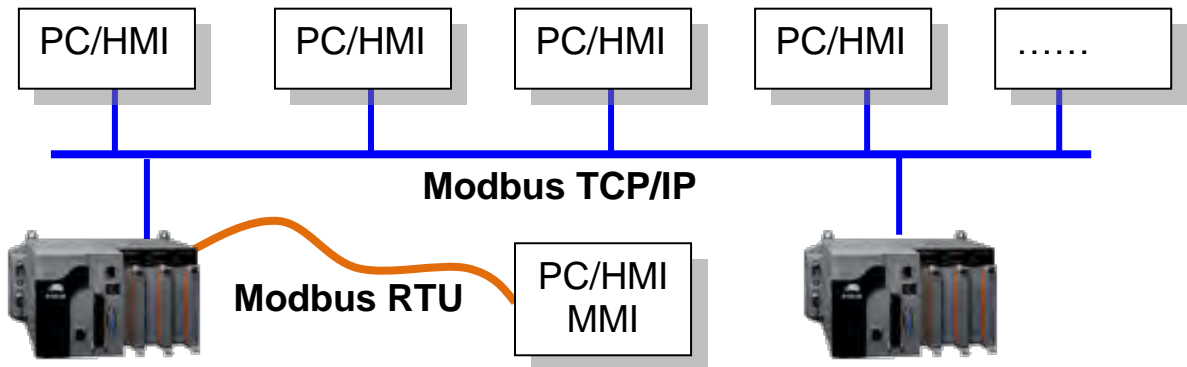

Options: Industrial Ethernet switch:

http://www.icpdas.com/products/Switch/switch_list.htm

NS-205: 10/100M , 5 ports

NS-208: 10/100M , 8 ports

COM1 ~ COM5 Pin Assignment:

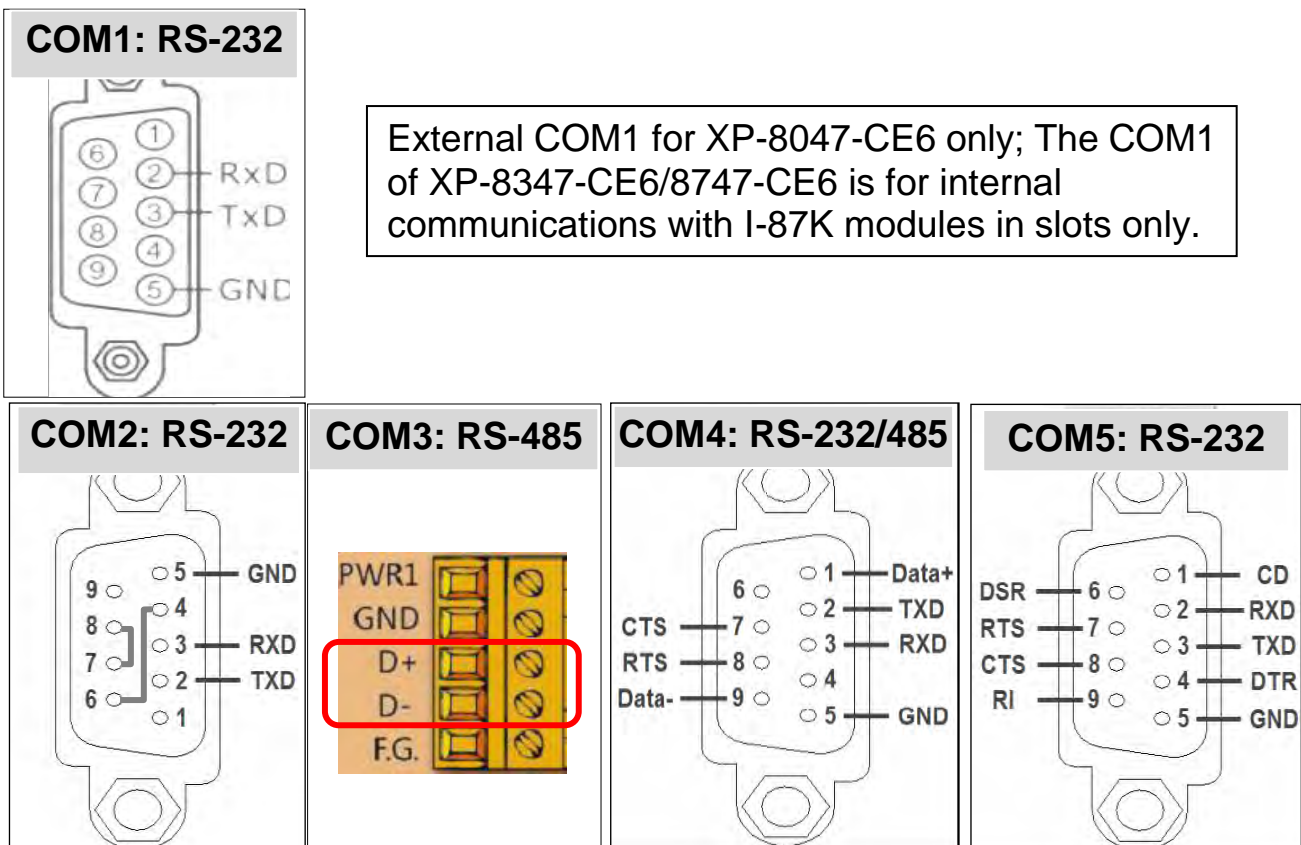

A.6 Connecting PC To The XP-8xx7-CE6 COM Ports

The default Modbus RTU slave port is “None” for XPAC. Run “isaXPce6” can set it to “COM2:RS-232” or “COM3:RS-485” or “None” (refer to the Appendix A.2). For setup the other ports COM1,4~33 please refer to the appendix G & E. Default communication parameter is “19200,8,N,1”

● RS-232 :

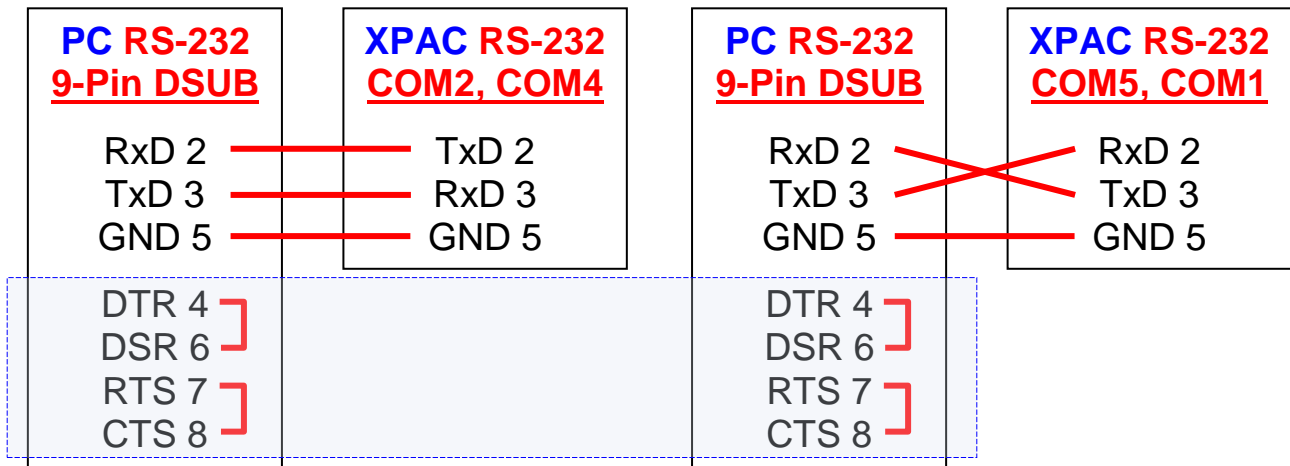

COM2~COM5 are for all XP-8xx7-CE6 modules.

COM1 is only for XP-8047-CE6 modules.

COM6~33 are on the optional expansion cards, refer to the Appendix G, E.

For the ISaGRAF Workbench RS-232 communications to operate properly, only the RxD, TxD and GND signals are used. If your PC is running a hardware device or software program that uses the CTS and DSR signals, please wire the RTS-CTS and DTR-DSR signals together as blue area shown above.

● RS-485 :

If connecting PC to the XPAC RS-485, an RS-232/485 converter I-7520(R) is necessary as below.

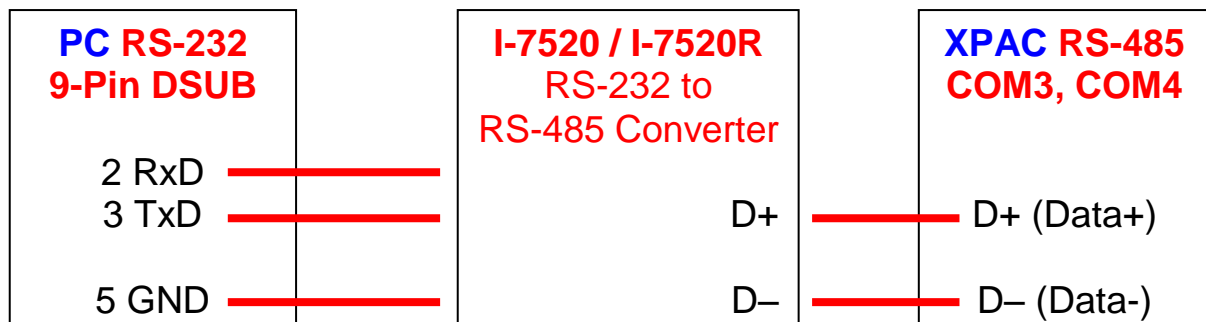

A.7 Deleting the ISaGRAF Project From XP-8xx7-CE6

For some reasons, user may delete the ISaGRAF program in the XPAC.

1. Run "isaXPce6"



2. Click on "Setting" & then click on "Delete" of the "Current Application".

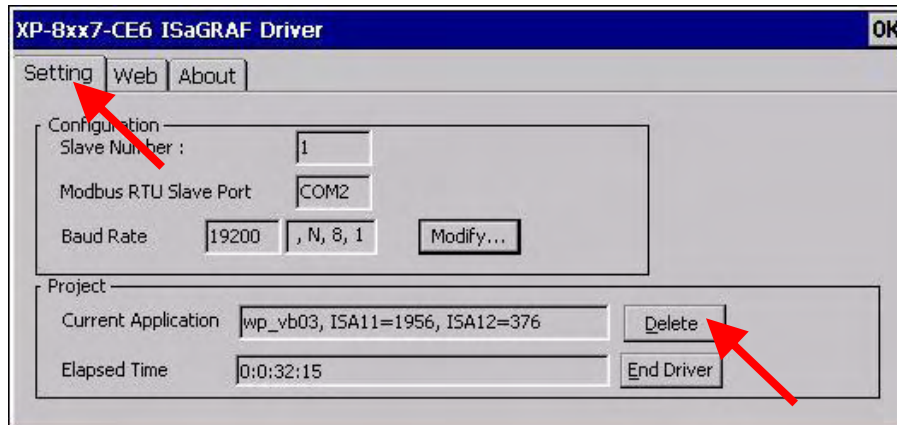

Delete XP-8xx7-CE6's ISaGRAF program if some software damage happens causing the WinCE software hanging:

1. Please turn the rotary switch to position 1 (Safe mode) of the XPAC. Then reset the XPAC-8xx7-CE6 again.
2. The XPAC will boot up as safe mode. Then get into the "My Device" on the WinCE desktop. Please go to the "\\System_Disk\\isagraf\\" directory, delete file "ISA11". The "ISA11" is the ISaGRAF current running application. (If you can't find "ISA11" in that directory, please goto [Internet Explorer] > [View] > [Internet Options] to modify the setting)
3. Turn the rotary switch to position 0 (Normal mode), then reboot XPAC. When ISaGRAF is connected, it will display "No Application" .
4. When XPAC boots up in "Safe mode" and back to the "Normal mode", user needs to set up the IP setting of LAN1/LAN2 and other non-default setting again. (Like the auto-execution of "isaXPce6.exe")

A.8 Linking I-7000 and I-87K Modules For Remote I/O

The XPAC controller system can use one of its COM3 or COM4(RS-485) signal to link to ICP DAS's "I-7000" and "I-87K" series of remote I/O modules. This configuration can be very useful in applications that require distributed remote I/O throughout the system.

You can link up to **255** I-7000 or I-87K series remote modules to one XP-8xx7-CE6 controller system (It is better not to link more than 40 pcs. of I-7000 or I-87K). Remember to set each I-7000 and I-87K remote module to has a unique address, and set to the same baud rate as the XPAC controller system.

For more information regarding setting up and programming an I-7000 / I-87K remote module, please refer to Chapter 6 - "Linking To I-7000 and I-87K Modules" of the "User's Manual Of The ISaGRAF PAC" .

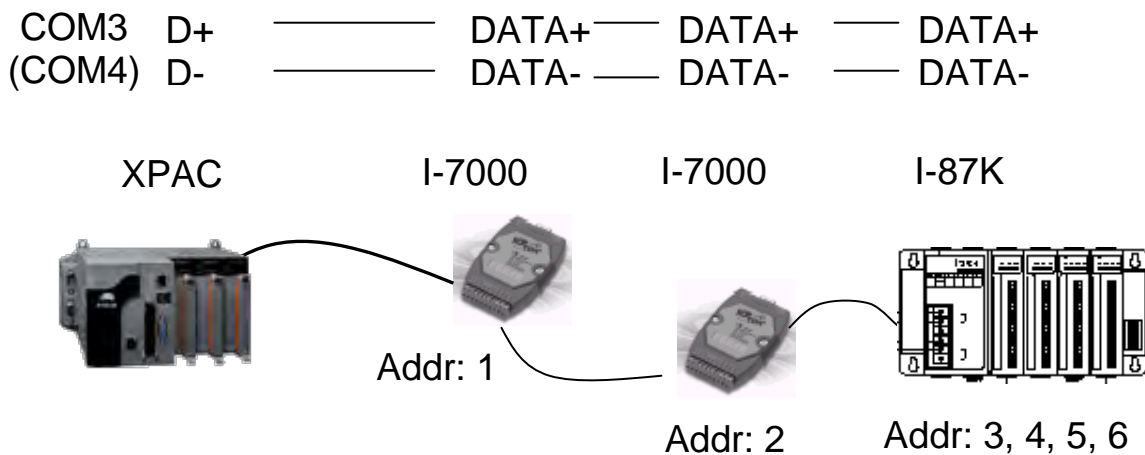

A.9 Linking To An HMI Interface Device

One of the COM2/COM3(appendix A.2) and up to 8 of the COM1,4~33 (appendix G & E) ports of the XP-8xx7-CE6/8xx6-CE6 PAC system can be used to interface with additional Human Machine Interface (HMI) devices such as touch displays.

ICP DAS provides a full line of touch screen displays, such as the "Touch" series screens. The models in the product line include the Touch 500, Touch 8000 and Touch 6000 series products.

For more information regarding interfacing the Touch series of MMI devices to the XP-8xx7-CE6 / 8xx6-CE6 PAC system, please refer to Chapter 4- "Linking The I-8xx7 To HMI Devices" of the "User's Manual Of ISaGRAF PAC" ..

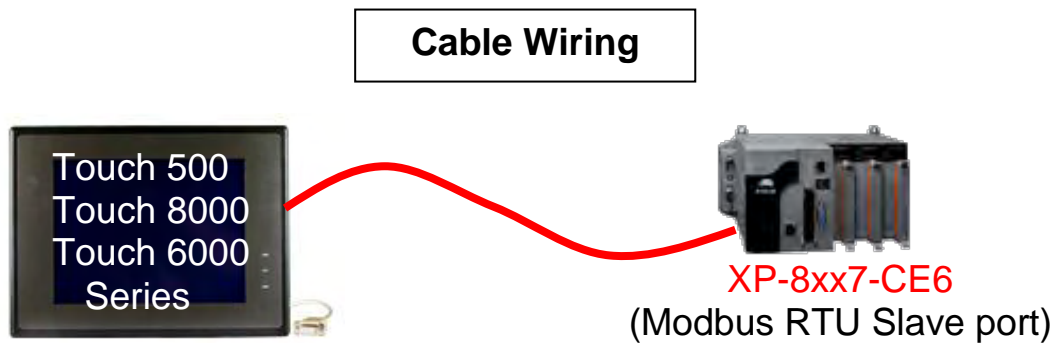

RS-232

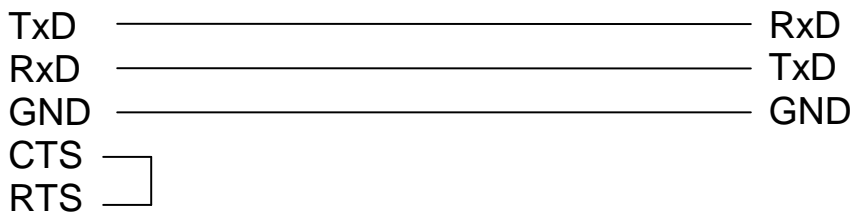

RS-232

RS-485

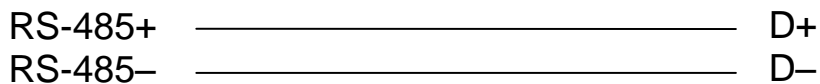

RS-485

A.10 Linking To Other Modbus Devices

The COM1 ~ COM33 (max. 33 ports) of XP-8xx7-CE6 support Modbus RTU / ASCII Master protocol to connect to Modbus RTU/ASCII slave devices. Please refer to Chapter 8 of the “User’s Manual Of ISaGRAF PAC” for more information.

RS-232:

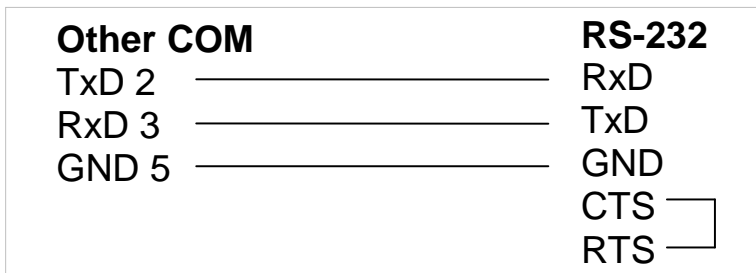
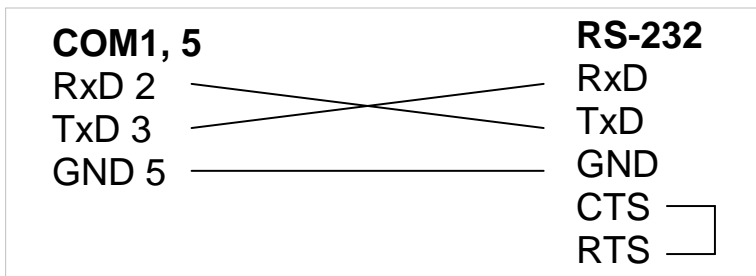
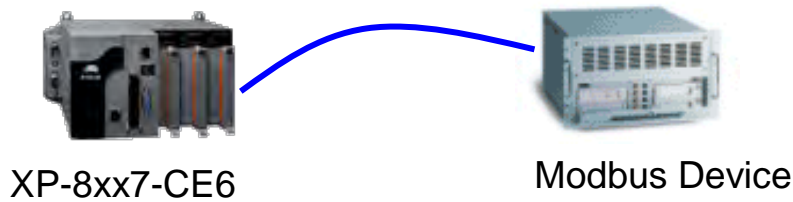

RS-485:

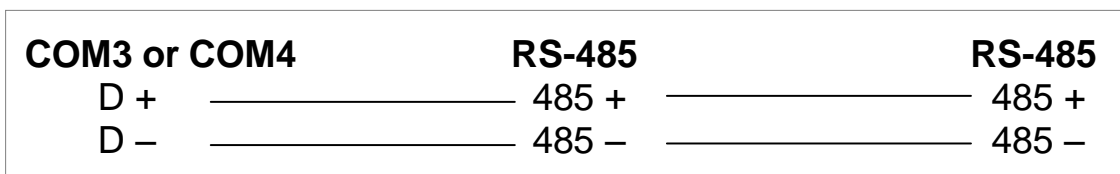
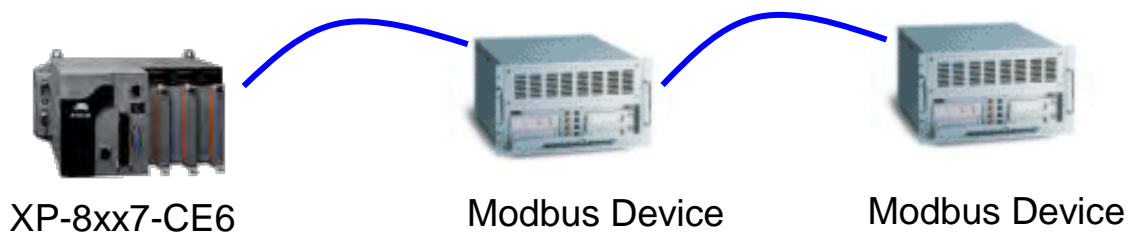

Appendix B Upgrade XPAC's ISaGRAF Driver to Newer Version

Note:

If you have purchased XP-8xx7-CE6, the ISaGRAF Driver is already installed with license when shipping out. You don't need to install it. However if you want to upgrade to newer version, you may upgrade it by yourself.

The XPAC ISaGRAF driver can be obtained in the XP-8xx7-CE6 CD-ROM:

[\napdos\isagraf\xp-8xx7-ce6\driver\<<version Number>](#)

EX: version 1.01 is located at [\napdos\isagraf\ xp-8xx7-ce6\driver\1.01\](#)

Or download it from

<http://www.icpdas.com/products/PAC/i-8000/isagraf.htm> > Driver

1. If your XPAC is XP-8xx7-CE6/XP-8xx6-CE6, please run "isaXPce6", click on "End Driver" to stop ISaGRAF Driver first. However if it is XP-8xx1/8xx9 (XPAC without ISaGRAF license), please goto step 2.

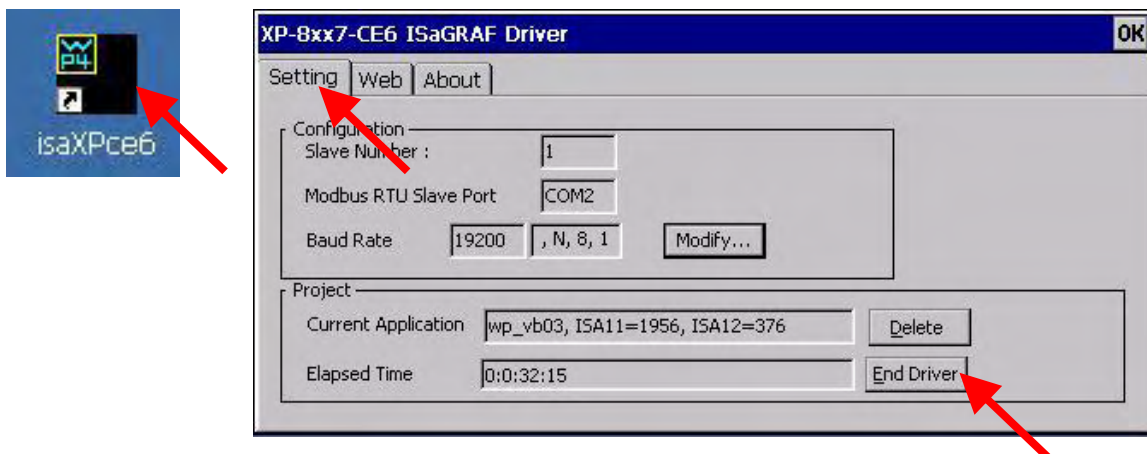

2. Set up XPAC's IP, Mask, FTP directory & Auto-execute
 - A. Create a folder "isagraf" inside "\System_Disk" folder in your XPAC. Then it will be \System_Disk\isagraf\
 - B. Run [Start] > [Setting] > [Control Panel] on the XPAC, then double click on "Network and Dial-up Connections". Then set your XPAC's IP address & Subnet Mask of "LAN1" and "LAN2". (Please always set IP as Fixed IP for ISaGRAF application, No DHCP)

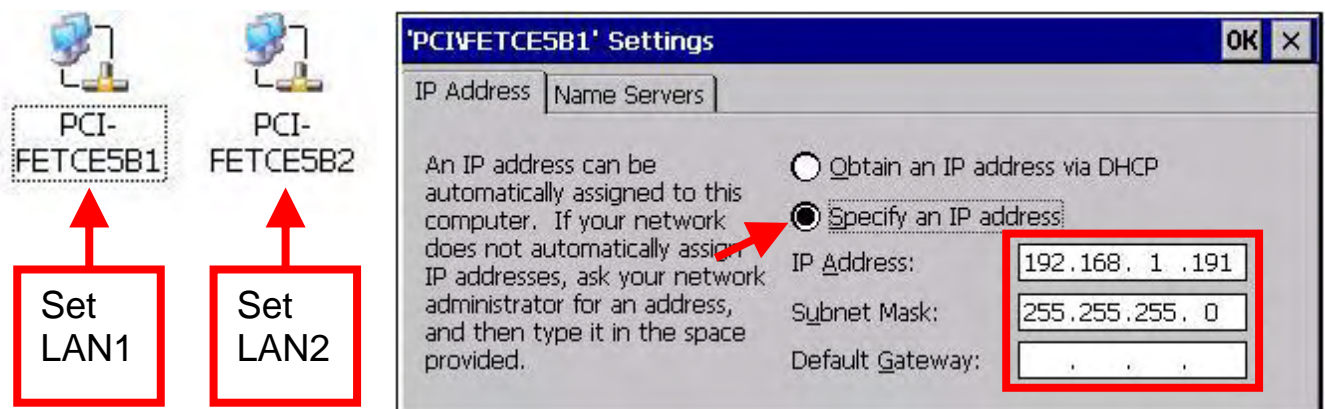

C. Please run [Start] > [Programs] > [XPAC Utility] > [Network]. Set FTP directory to the root directory “\”. Check all Network options as “Enable”. Then click on “Apply”. If the Input Panel is needed, click on the “SipPanel” icon in the right coner.

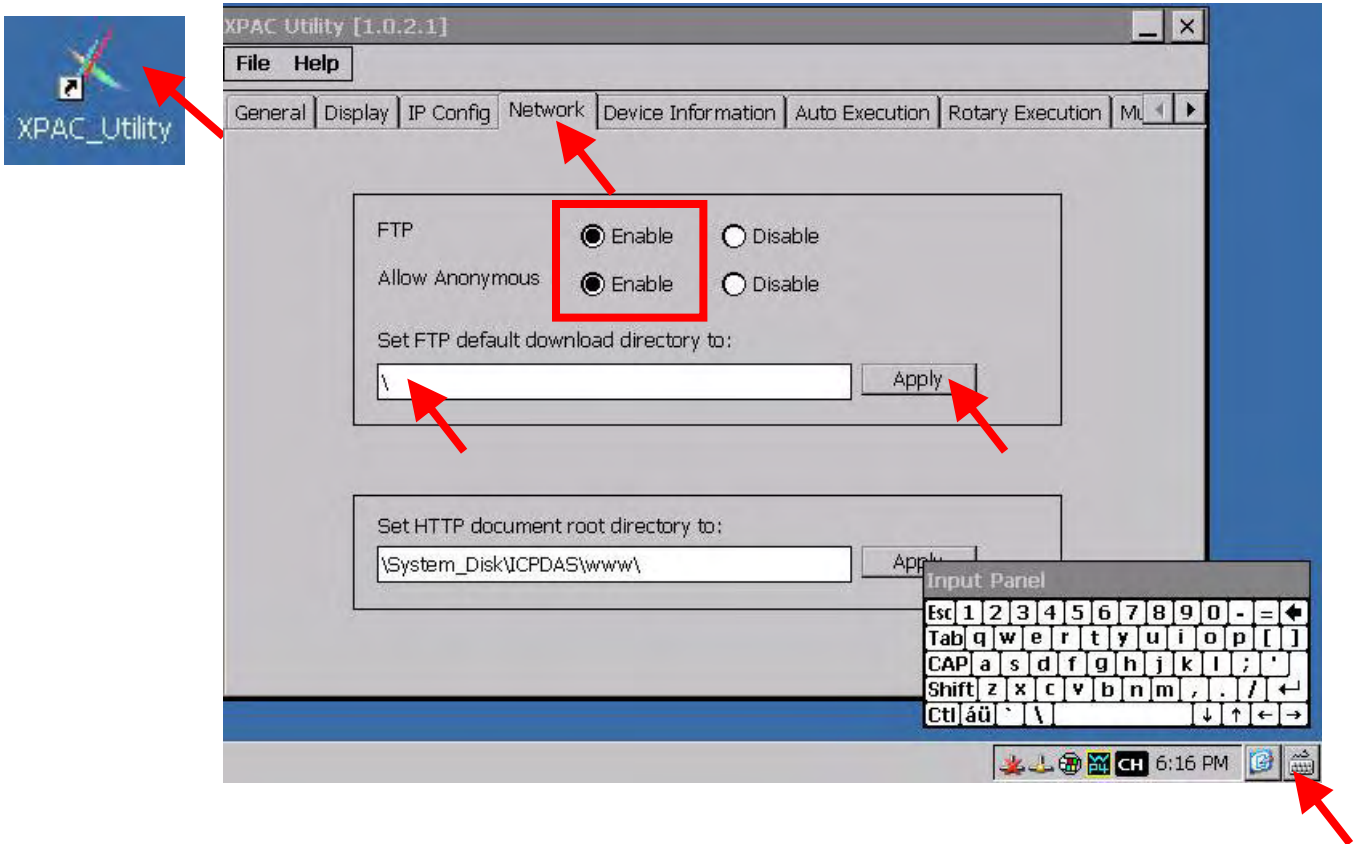

D. Click “Auto Execution”, “Browse” to select or type “\System_Disk\isagraf\isaXPce6.exe”, then click on “Apply”.

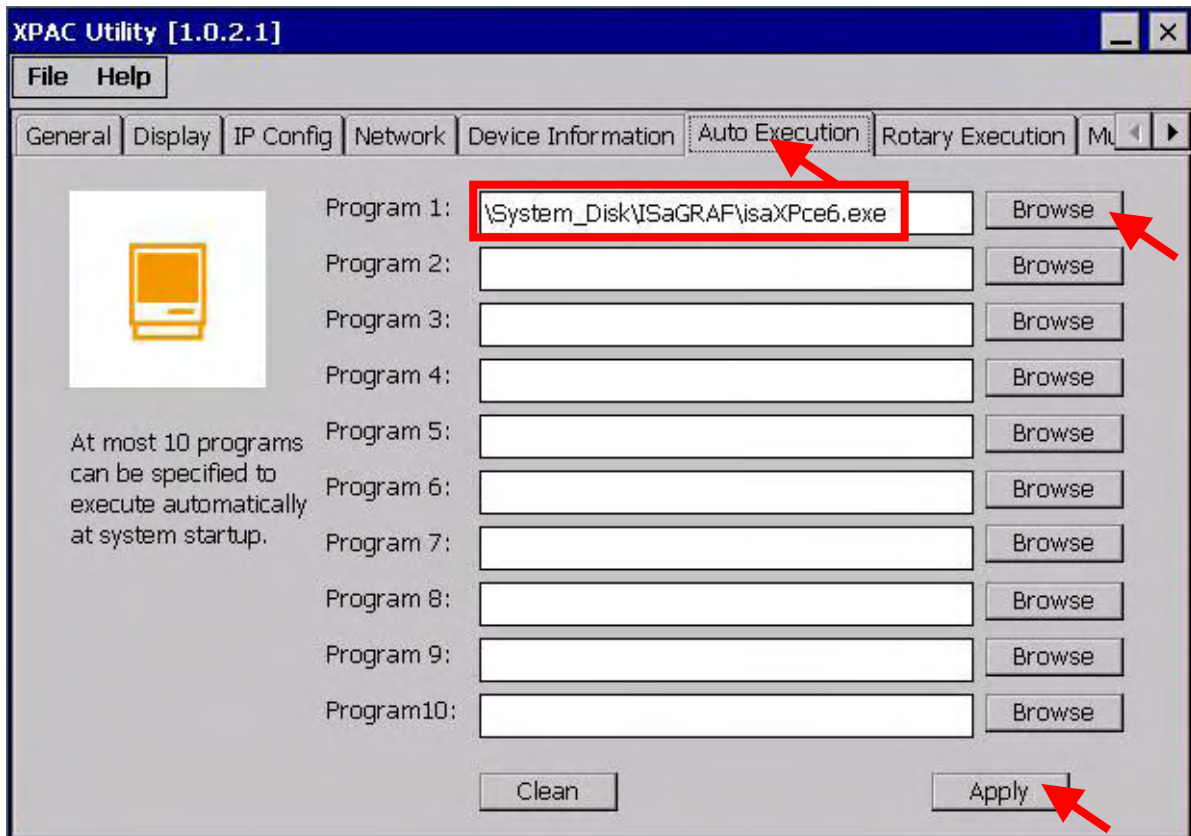

3. Download the files from PC to XPAC directory “\System_Disk\isagraf” :

isaXPce6.exe, rs_wphmi.exe
mscorlib.dll, QuickerNet.dll, Quicker.dll, login.dll, main.dll, whmi_filter.dll
isaXPce6.lnk
(and “license.bin” if your XPAC is XP-8xx1-CE6/8xx9-CE6)

Note: If the ISaGRAF driver is still running, the files copied are failed even your eyes tell you it is successful. So, you must do the step 1 “End Driver”.

You may use PC's ftp utility to download these files.

Please open Internet browser and then type in <ftp://<IP address>>, for ex. [Ftp://192.168.1.178](ftp://192.168.1.178) , browse it to the \System_Disk\isagraf\ . Then copy all of them & past it.

Then remember to re-start your XPAC's power again. After it re-boot again, it will have the new ISaGRAF driver running. You can check if the version is correct.

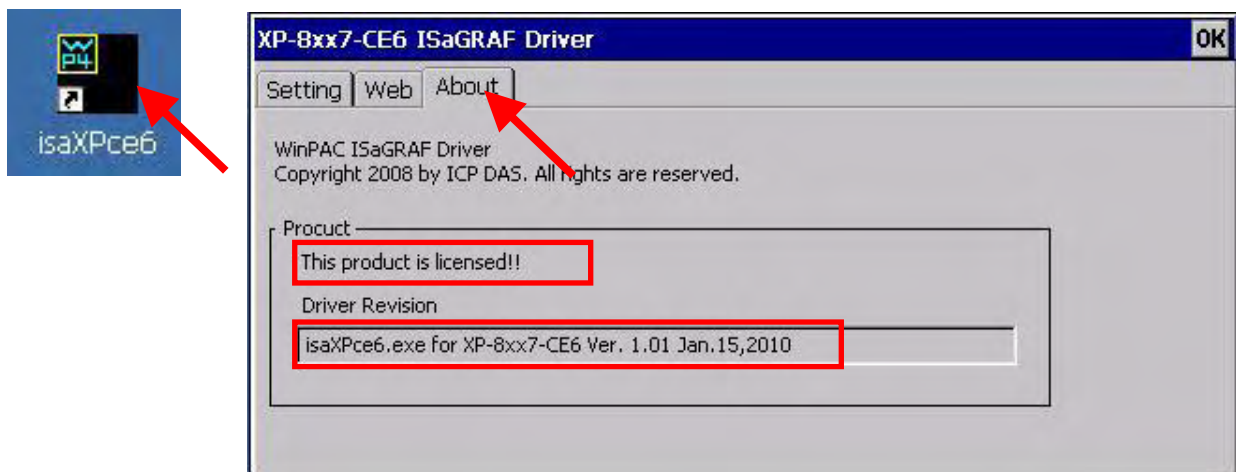

Appendix C Dimension

Unit: mm

XP-8047-CE6

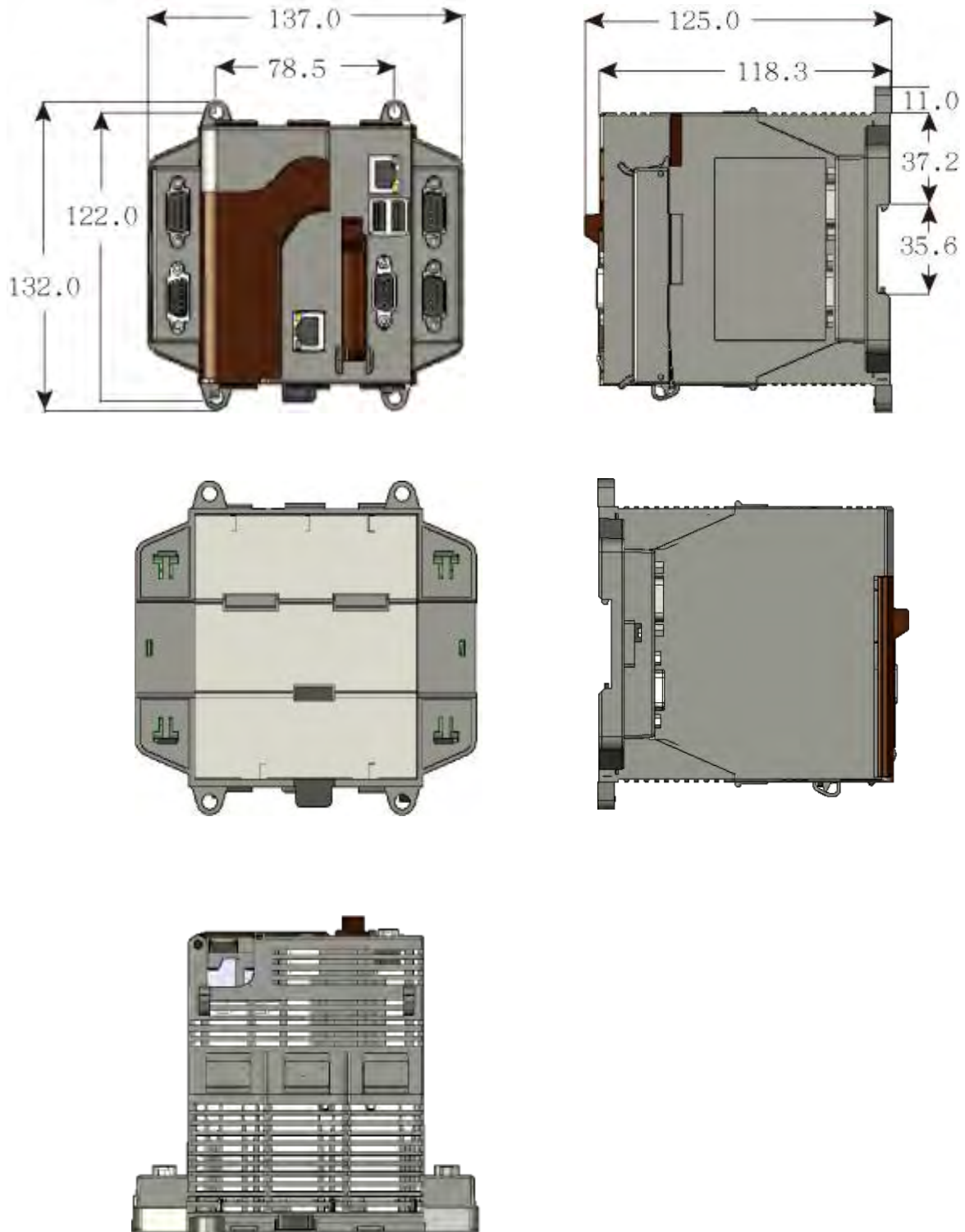

XP-8347-CE6

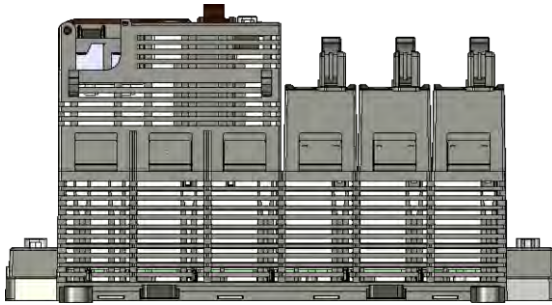
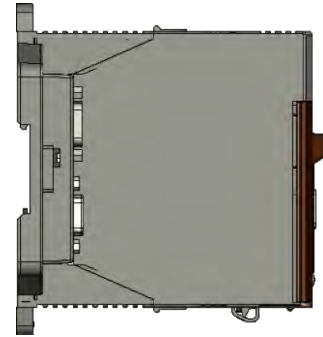
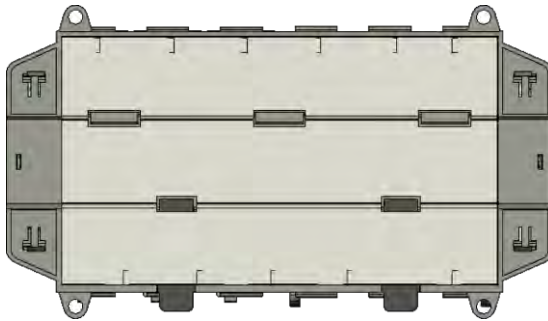
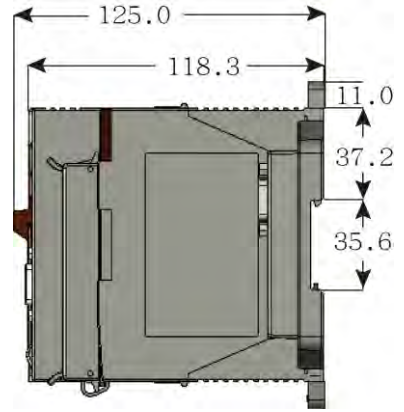
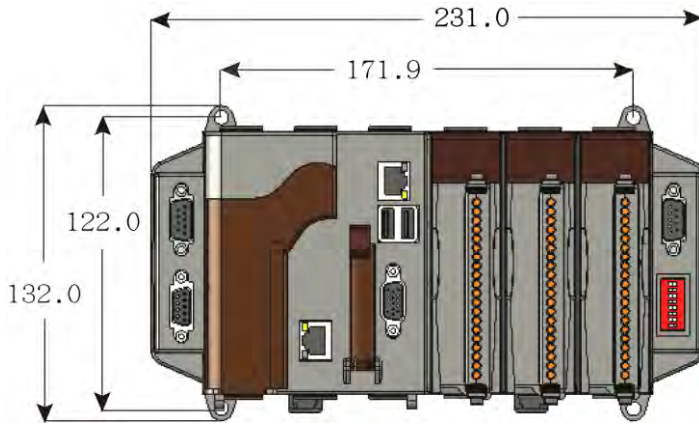

XP-8747-CE6

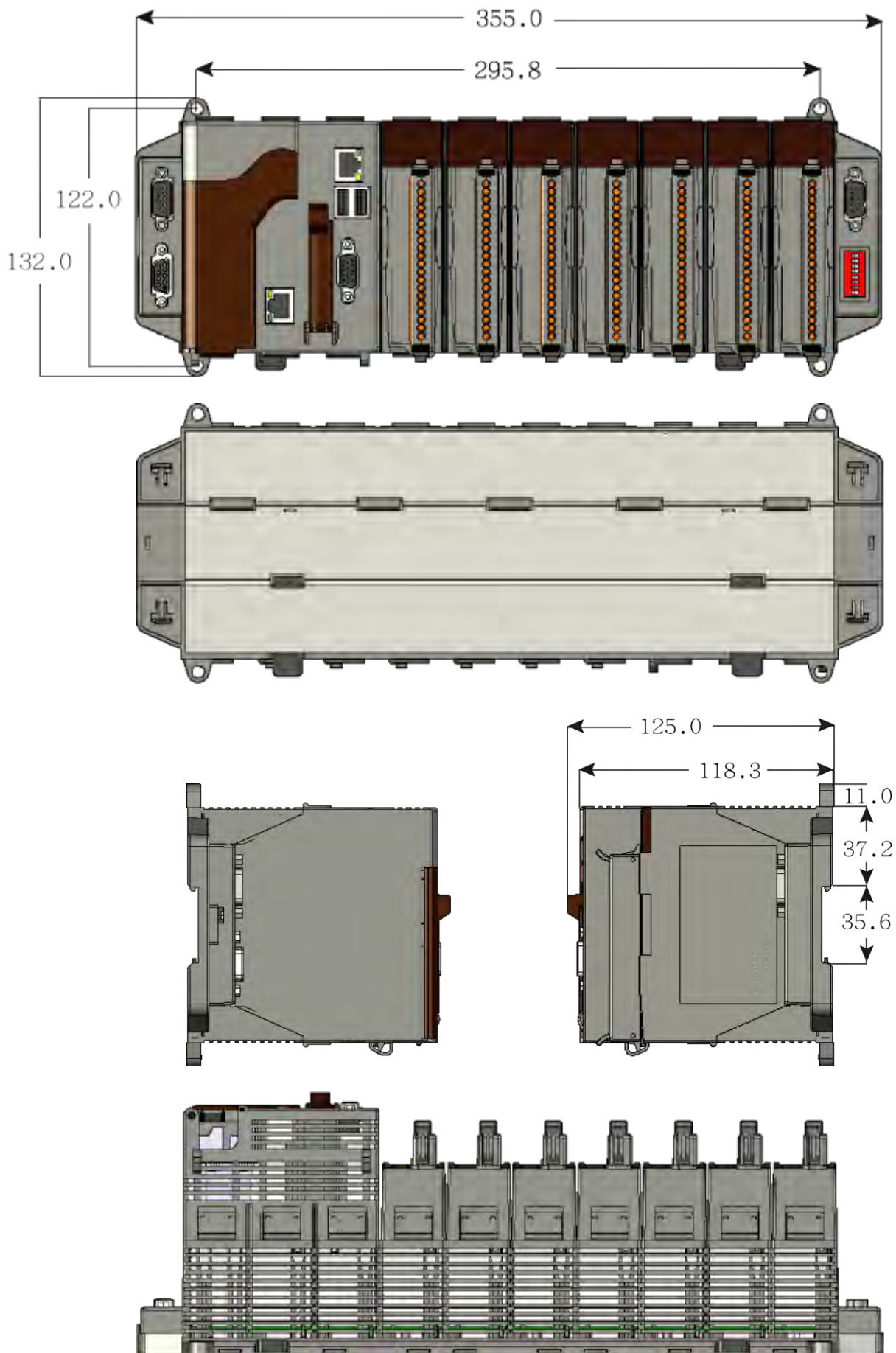

Appendix D How to Enable/Disable XP-8xx7-CE6's LAN2

Important Notice:

1. Recommend to use NS-205 or NS-208 Industrial Ethernet Switch for XPAC.
2. Always set a fixed IP to LAN1 (and LAN2 if it is enabled) for ISaGRAF applications.

The default setting of XP-8xx7-CE6's LAN2 is disabled. User must enable it before using LAN2 port.

ISaGRAF **must** use XPAC's LAN2 when using "Ebus" (section 7.5 of the ISaGRAF User's Manual) and "New Redundant system" (please refer to www.icpdas.com > FAQ > Software > ISaGRAF > 093). ISaGRAF **may** use LAN2 when using "Delivering message via UDP or TCP" (section 19.2 and 19.3 of the ISaGRAF User's Manual).

1. Click [Start] > [Setting] > [Control Panel] > [Network and Dial-up Connections]
2. Mouse right click on "PCI-FETCE5B2", select "Enable" to enable LAN2 (Click "Disable" to stop).

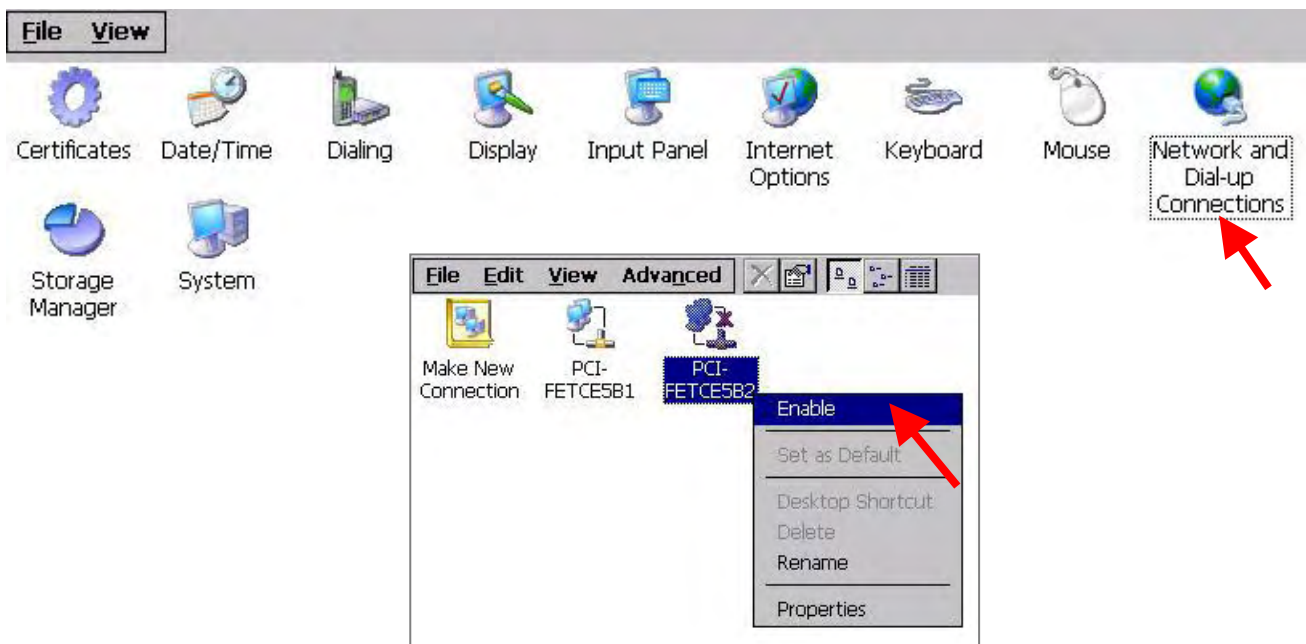

Appendix E Using Expansion RS-232 / 485 / 422

The XPAC can expand COM6~COM33 in its slot No. 1 to 7 by using following modules.

- I-8112iW : 2-channel isolated RS-232
- I-8114iW : 4-channel isolated RS-232
- I-8114W : 4-channel non-isolated RS-232
- I-8142iW : 2-channel isolated RS-422/RS-485
- I-8144iW : 4-channel isolated RS-422/RS-485

Before user can use them, please configure them by the “XPAC_Utility”.

1. Plug in the cards to the XPAC's slot 1 to 7.
(here using Slot 1:I-8112iW & Slot 2: I-8114iW)
2. Run XPAC_Utility
3. Click on “Multi-IO Modules” (click  can show the hidden page tags). The current found multi-serial port cards will be listed on the page.

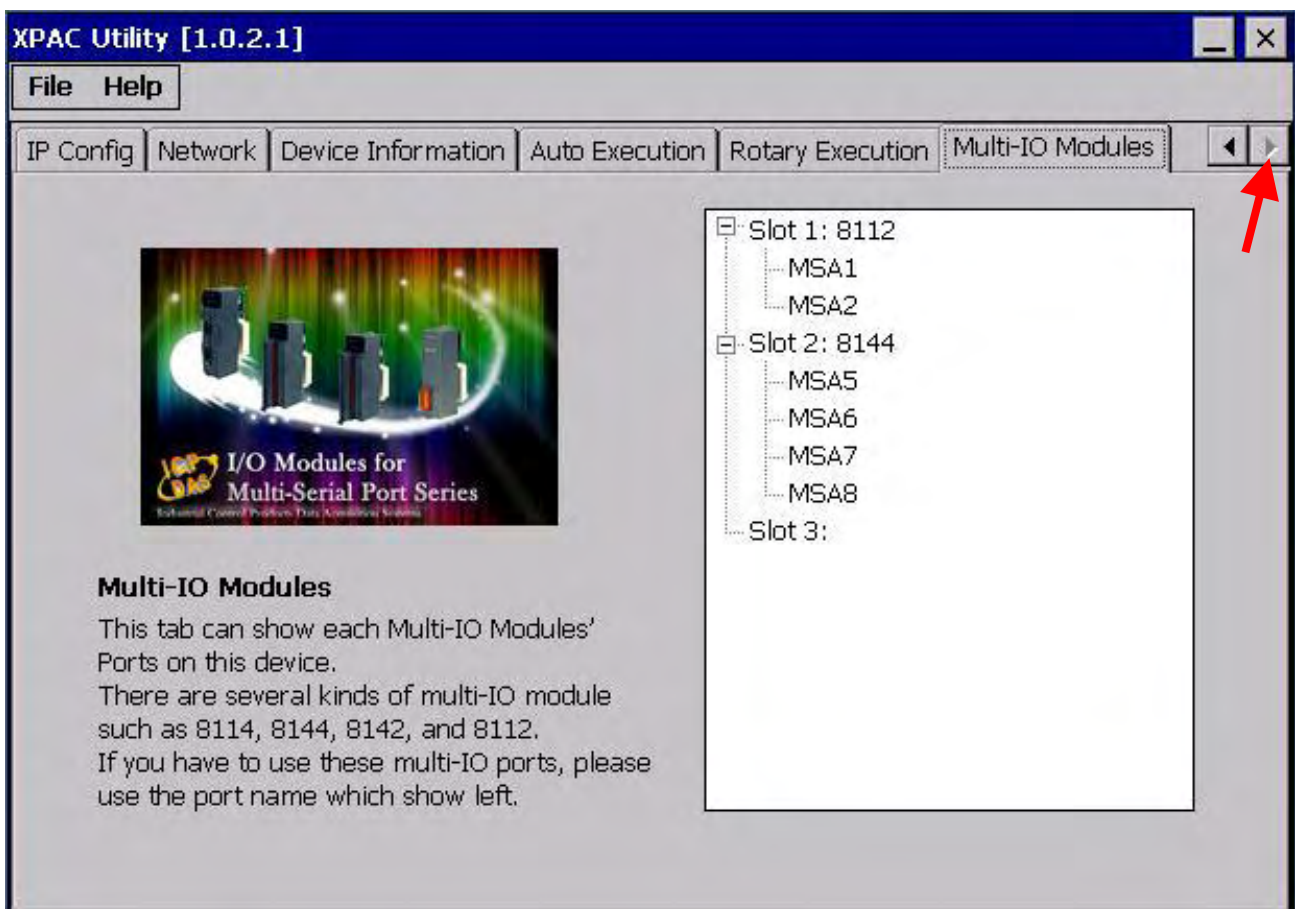

The COM port No. for the expansion board is COM6 to COM33 in the ISaGRAF definition.

The relation between XPAC's COM setting and the ISaGRAF definition is as the following:

Slot	XPAC	ISaGRAF	Slot	XPAC	ISaGRAF
Slot 1	MSA1	COM6	Slot 5	MSC1	COM22
	MSA2	COM7		MSC2	COM23
	MSA3	COM8		MSC3	COM24
	MSA4	COM9		MSC4	COM25
Slot 2	MSA5	COM10	Slot 6	MSC5	COM26
	MSA6	COM11		MSC6	COM27
	MSA7	COM12		MSC7	COM28
	MSA8	COM13		MSC8	COM29
Slot 3	MSB1	COM14	Slot 7	MSD1	COM30
	MSB2	COM15		MSD2	COM31
	MSB3	COM16		MSD3	COM32
	MSB4	COM17		MSD4	COM33
Slot 4	MSB5	COM18			
	MSB6	COM19			
	MSB7	COM20			
	MSB8	COM21			

Note:

1. Please refer to the section 8.4 of the ISaGRAF User's Manual for multi-ports Modbus Master.
XP-8xx7-CE6 can setup max. 33 Modbus RTU/ASCII Master ports (COM1 ~ 33).
2. Please refer to the Appendix A.4 of the ISaGRAF User's Manual for COM_OPEN, COM_READ, ... functions to read write COM ports.
3. Please refer to the Appendix G of this manual for setting up more Modbus RTU slave ports.

Pin assignment :

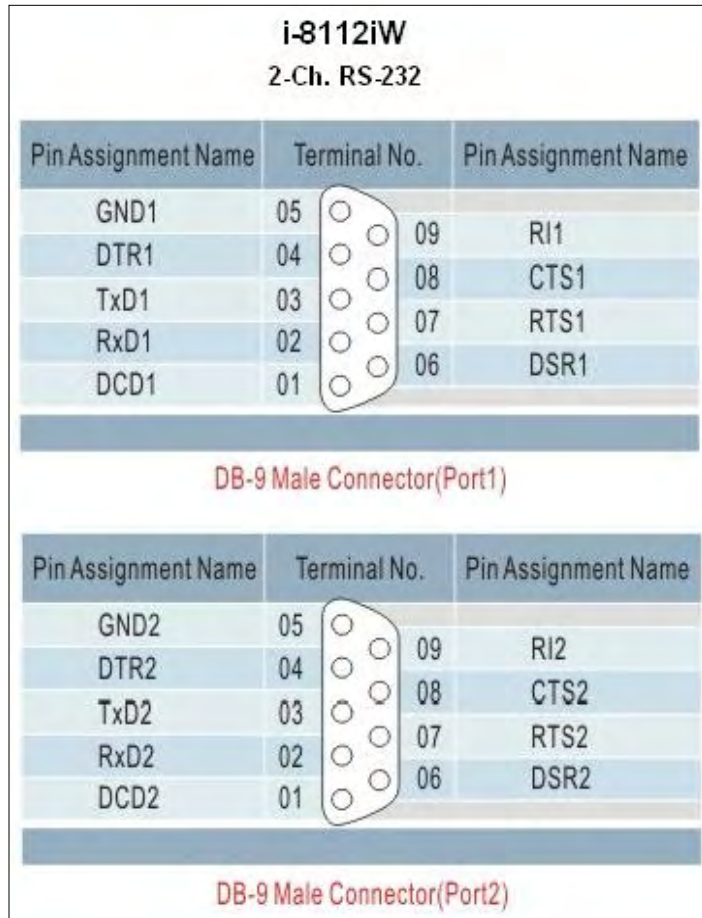

i-8114W / i-8114iW

4-Ch. RS-232

Pin Assignment Name	Terminal No.	Pin Assignment Name
N.C.	01	
DCD3	02	RI3
GND	03	DTR3
CTS3	04	DSR3
RxD3	05	RTS3
RI4	06	TxD3
DTR4	07	DCD4
DSR4	08	GND
RTS4	09	CTS4
TxD4	10	RxD4
DCD2	11	RI2
GND	12	DTR2
CTS2	13	DSR2
RxD2	14	RTS2
RI1	15	TxD2
DTR1	16	DCD1
DSR1	17	GND
RTS1	18	CTS1
TxD1	19	RxD1

37-Pin Female D-Sub Connector (Port1~Port4)

i-8142iW

2-Ch. RS-422 / RS-485

RS-485 Ch.1 = (D1+ , D1-)

RS-485 Ch.2 = (D2+ , D2-)

RS-422 Ch.1 = (TxD1+ , TxD1- , RxD1+ , RxD1-)

RS-422 Ch.2 = (TxD2+ , TxD2- , RxD2+ , RxD2-)

Terminal No.	Pin Assignment Name
01	D1+/TxD1+
02	D1-/TxD1-
03	RxD1+
04	RxD1-
05	GND1
06	D2+/TxD2+
07	D2-/TxD2-
08	RxD2+
09	RxD2-
10	GND2
11	N.C.
12	N.C.
13	N.C.
14	N.C.
15	N.C.
16	N.C.
17	N.C.
18	N.C.
19	N.C.
20	N.C.

i-8144iW

4-Ch. RS-422 / RS-485

RS-485 Ch.1 = (D1+ , D1-)

RS-485 Ch.2 = (D2+ , D2-)

RS-485 Ch.3 = (D3+ , D3-)

RS-485 Ch.4 = (D4+ , D4-)

RS-422 Ch.1 = (TxD1+ , TxD1- , RxD1+ , RxD1-)

RS-422 Ch.2 = (TxD2+ , TxD2- , RxD2+ , RxD2-)

RS-422 Ch.3 = (TxD3+ , TxD3- , RxD3+ , RxD3-)

RS-422 Ch.4 = (TxD4+ , TxD4- , RxD4+ , RxD4-)

Terminal No.	Pin Assignment Name
01	D1+/TxD1+
02	D1-/TxD1-
03	RxD1+
04	RxD1-
05	GND1
06	D2+/TxD2+
07	D2-/TxD2-
08	RxD2+
09	RxD2-
10	GND2
11	D3+/TxD3+
12	D3-/TxD3-
13	RxD3+
14	RxD3-
15	GND3
16	D4+/TxD4+
17	D4-/TxD4-
18	RxD4+
19	RxD4-
20	GND4

Appendix F Slow Down ISaGRAF Driver's Speed

You may wonder why? The faster speed is not good?

The reason to slow down the speed of ISaGRAF driver is when you running some other HMI program (For example, InduSoft, or VB.net program) with ISaGRAF at the same time. Because the CPU is the only one CPU, all programs running in XPAC must share execution time of the same CPU. If you feel the HMI program behavior is not so smooth, or slow, you may use ISaGRAF function – "PLC_Mode()" to slow down the speed of the ISaGRAF driver.

PLC_Mode

Description:

Function Change the ISaGRAF driver speed

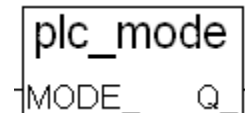

Argument:

MODE_ integer Can be 0 , 1, 2, or 3

0: Fast Mode, Default setting, the minimum PLC scan time is about 2~3 ms

1: Slow Mode, the minimum PLC scan time is about 6~7 ms

2: Slower Mode, the minimum PLC scan time is about 9~11 ms

3 or other value: Slowest Mode, the min. PLC scan time is about 19~21 ms

Return:

Q_ boolean always return True

Note:

1. The system's default setting is "Fast Mode"
2. User may call "PLC_mode()" in the first PLC scan to change the PLC speed.
3. The reason to slow down the PLC speed is to improve the speed performance of other HMI program running with ISaGRAF driver at the same time, for example, running InduSoft with ISaGRAF in the same WinPAC.

Example:

```
(* TMP is declared as Boolean internal variable *)
(* INIT is declared as Boolean internal variable and init at TRUE *)
if INIT then
  INIT := False ;                    (* Only do it once in the 1st PLC scan *)
  TMP := PLC_mode(2) ;            (* Set PLC speed to 2:slower mode *)
end_if ;
```

Appendix G Setup More Modbus RTU Slave Ports

The XP-8xx7-CE6/XP-8xx6-CE6 can setup up to 9 Modbus RTU slave ports in one of the COM2/COM3 and in 8 of the COM1, 4~33 (COM6 to COM33 are the expansion multi-serial ports in slot 1 to 7, refer to the appendix E) .

Note about COM1:

Only the COM1 of XP-8047-CE6/ 8046-CE6 can set up as Modbus RTU slave port, the COM1 of 3/7 slots models cannot.

1. The first Modbus RTU slave port can be one of the COM2 or COM3 which can be set via “isaXPce6” setting by mouse (refer to the appendix A.2).
2. Eight of the COM1, 4~33 may be enabled as the 2nd , 3rd , ... or 9th Modbus RTU slave port. (No support other COM port number). Before using this function, please make sure the above ports do exist and well configured. (refer to the appendix E)
3. Via 2nd ~ 9th Modbus RTU slave port, user may use ISaGRAF to Debug/Set_val to the PAC, however user cannot Stop/Download/Update the ISaGRAF program.
4. To Stop/Download/Update the ISaGRAF program, please use Ethernet port or the first Modbus RTU slave port (if enabled from one of the COM2 or COM3). The other slave ports (the 2nd~9th Modbus RTU slave ports if enabled from COM1,4 ~ 33) are not for ISaGRAF to Stop/Download/Debug.

How to setup ?

1. In the “Programs” windows of the ISaGRAF Workbench, open the “I/O connection” windows to set up the 2nd ~ 9th ports.

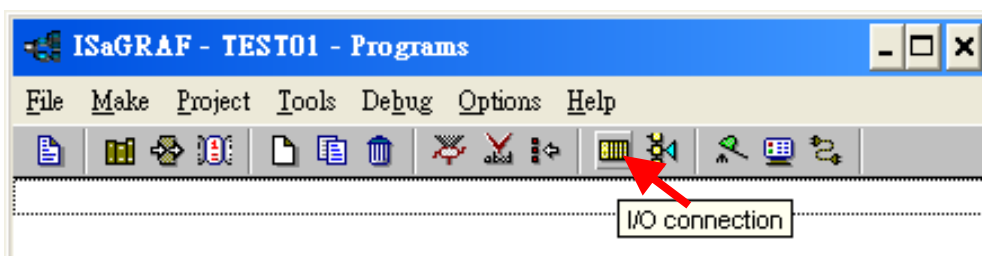

2. "Rtu_slav" is for setting the 2nd ~ 5th ports, and "Rtu_slav2" is for setting the 6th ~ 9th ports. When finish, re-compile the project and download to the XPAC via Ethernet (or the first Modbus RTU port).

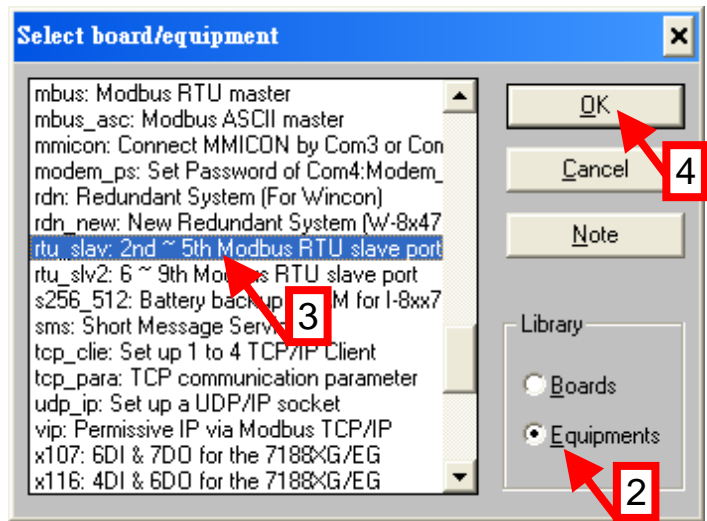
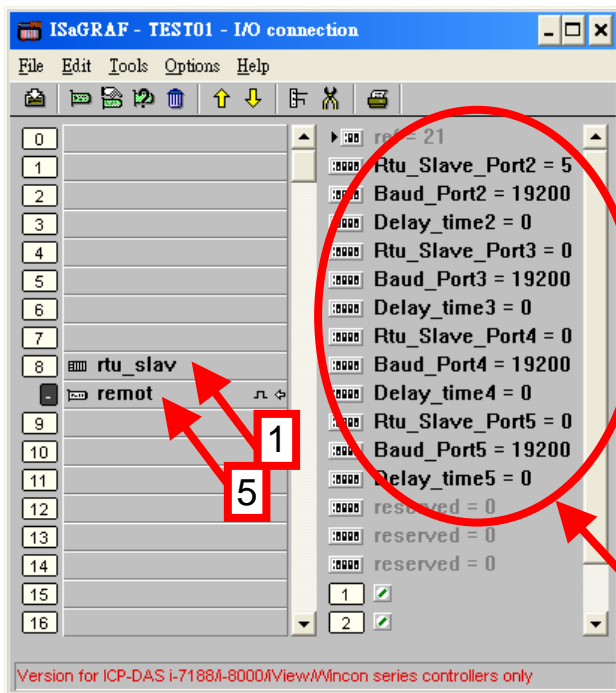

RTU_Slave_Port2 ~ 5 are for the 2nd ~ 5th ports, RTU_Slave_Port6 ~ 9 are for the 6th ~ 9th ports. Value can be 0,1 ~ 33 to enable COM1~33. Value of 0 means not enable it. Baud rate setting can be 600, 1200, 2400, 4800, 9600, 19200, 38400, 57600, 115200.

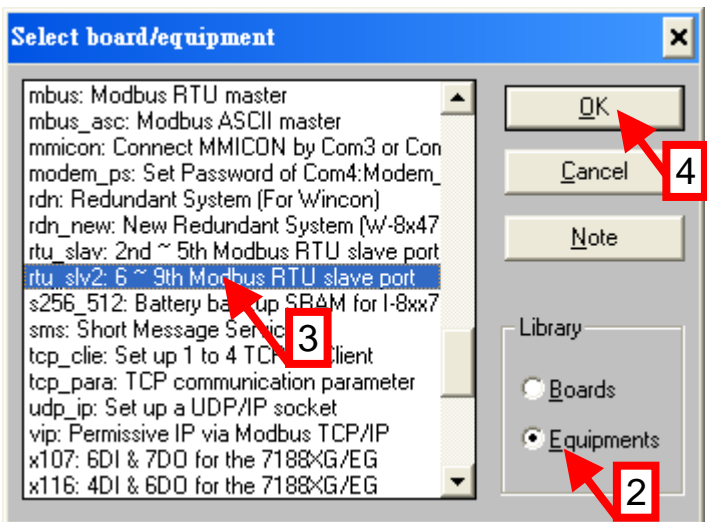
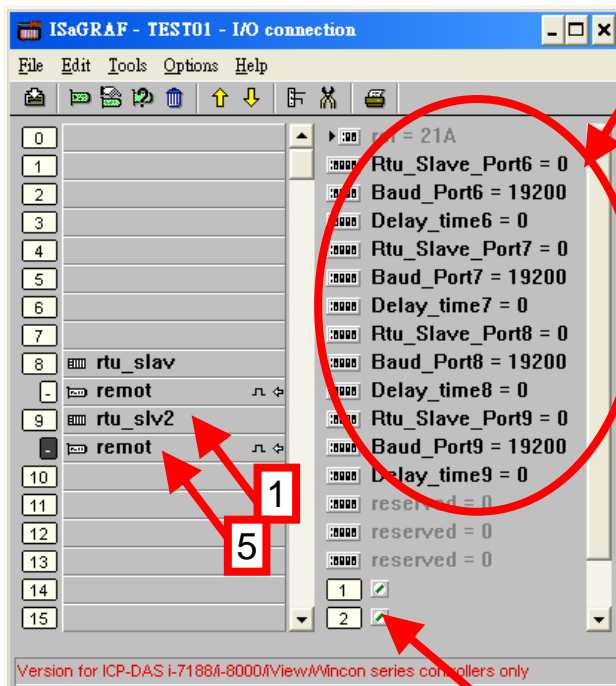

The 4-ch boolean inputs indicate the related port is well enabled or not.
True: Enable Ok.
False: Disabled.

Appendix H Compiling Error Result In Different ISaGRAF Version

In the recent years since 2003, all the ISaGRAF example programs provided in the ICP DAS CD-ROM & Web site are written in ISaGRAF workbench version of 3.46. If your ISaGRAF workbench is version of 3.51 or newer version, it may generate error when you re-compile these example programs.

To erase this kind of error in different ISaGRAF workbench version, please run **[Make] > [Touch]** once. And then re-compile this example project.

The **[Make] > [Touch]** command will reset all files that have been successfully compiled to become “Not compiled yet”.

The **[Make] > [Make application]** command will re-compile all of them.

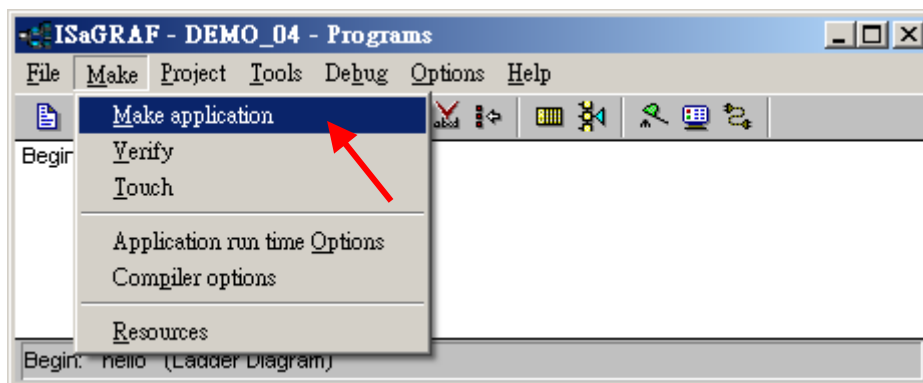
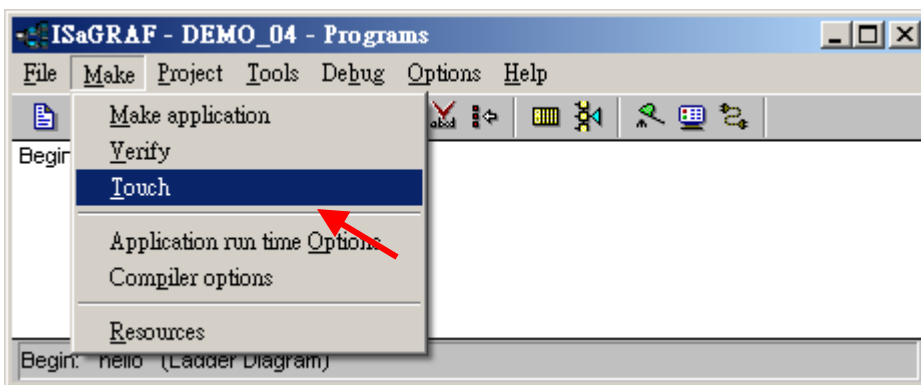

Appendix I Using RS-232 Serial/USB Touch Monitor

Reserved.

Appendix J Why my PC running ISaGRAF cannot connect the ISaGRAF PAC correctly ?

The document can also be download at www.icpdas.com > FAQ > Software > ISaGRAF > 104.

Sometimes when using the PC / ISaGRAF debugger to connect to the ISaGRAF PAC will pop-up a window like “Can not link ...” or “Can not download” or “Can not find BMP ...” or ...

To solve this problem, please do below steps.

1. First close all ISaGRAF windows. Then press and hold on “Ctrl” plus “Alt” key and then press “Delete” key to open the Task Manager.
2. Stop the process which is with empty memory. Then run PC / ISaGRAF again to connect to the controller.

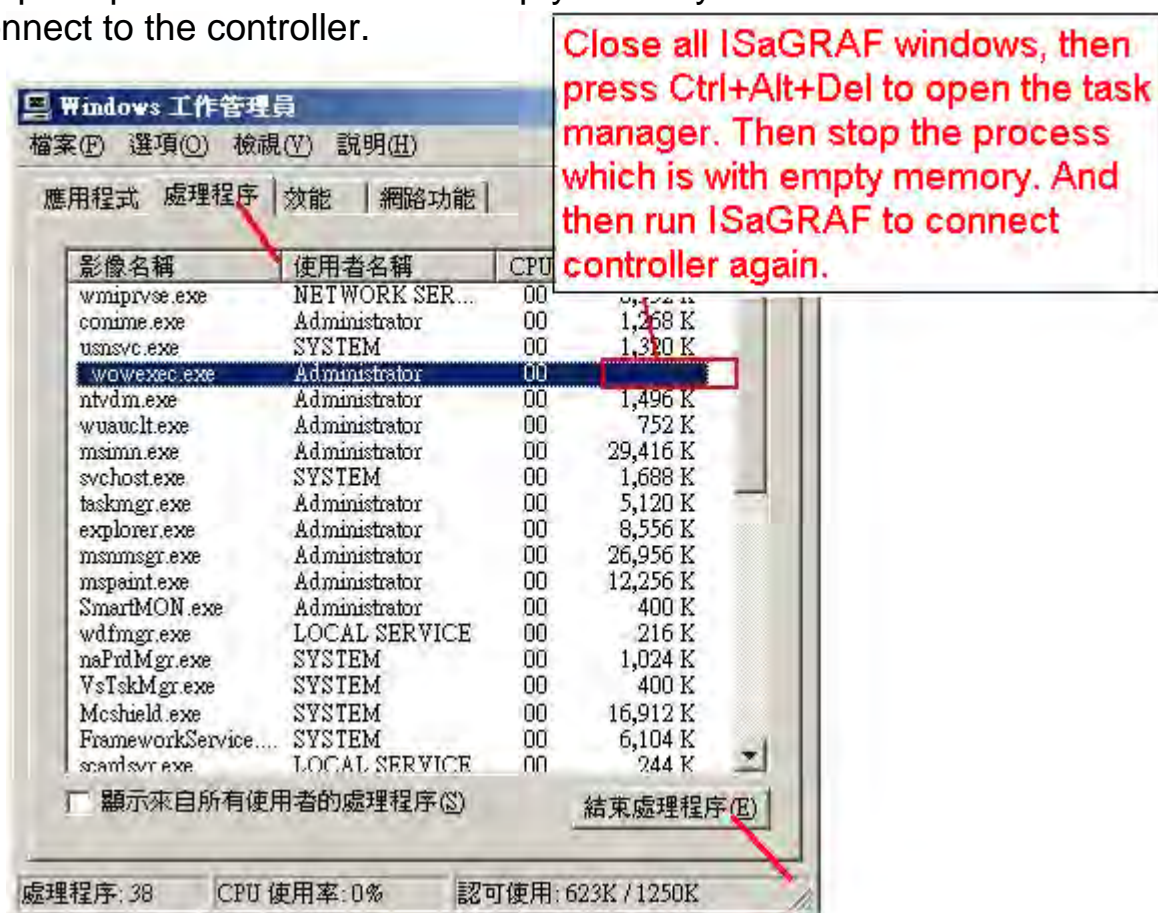

3. If the problem is still there and you are using Ethernet to connect the PAC, check if your PC and PAC are set in the same IP domain. For example, PC with (IP, Mask) = (192.168.1.2, 255.255.255.0) can not connect PAC = (192.168.3.5, 255.255.255.0). However it can connect the PAC = (192.168.1.5, 255.255.255.0) well.
4. If the problem is still there and you are using RS-232 to connect the PAC, check if your RS-232 cable is correct and check if you are setting the correct PC RS-232 port number to connect the PAC.
5. The last way is re-start your PC and try again.

Appendix K Enable the Screen Saver of XPAC

Reserved.